



Title	STUDIES ON THE QUALITY OF SEA FOOD
Author(s)	OISHI, KEIICHI
Citation	MEMOIRS OF THE FACULTY OF FISHERIES HOKKAIDO UNIVERSITY, 10(2), 67-136
Issue Date	1962-12
Doc URL	http://hdl.handle.net/2115/21838
Type	bulletin (article)
File Information	10(2)_P67-136.pdf



[Instructions for use](#)

STUDIES ON THE QUALITY OF SEA FOOD

KEIICHI OISHI

Faculty of Fisheries, Hokkaido University, Hakodate, Japan

CONTENTS

Introduction	68
Part I. Quality of fresh fish meat as represented by flatfish	69
1. Fifteen species of flatfish from Hakodate	69
2. Quality evaluation of the flatfish	72
2.1. Price ratio	72
2.2. Evaluation by sensory test	75
2.2.1. Difference according to body parts	75
2.2.2. Difference among individuals of the same species of flatfish	76
2.2.3. Difference according to species	77
2.3. Analysis of consumer survey	79
2.4. Discussion	80
2.5. Conclusions	81
3. Factors determining quality of the flatfish	81
3.1. Relation between quality and characteristics, ecological and morphological ..	81
3.2. Relation between quality and ordinary chemical constituents	83
3.3. Relation between quality and amount of connective tissue	93
3.4. Relation between quality and amount of acid soluble phosphorus	95
3.5. Relation between quality and extractive nitrogen	96
3.6. Relation between quality and amino acid composition of muscle extractive ..	97
3.7. Conclusions on factors determining quality of the flatfish	100
Part II. Quality of processed fish meat as represented by <i>katsuwo-bushi</i> (dried skipjack)	101
1. Samples of <i>katsuwo-bushi</i> and preparation of testing liquids	102
2. Relation between quality of <i>katsuwo-bushi</i> and amino acid composition of the extractive	104
3. Relation between quality of <i>katsuwo-bushi</i> and amounts of nucleotides, nucleoside and purine base	107
4. Relation between quality of <i>katsuwo-bushi</i> and fat content	108
5. Conclusions	109
Part III. Quality of edible seaweeds as represented by those belonging to the <i>Laminariaceae</i>	109
1. Grading according to <i>kombu</i> quality	112
1.1. Quality estimation according to taste of water extractive	112
1.2. Quality estimation according to viscosity	114
1.3. Quality estimation according to shearing force	114
1.4. Quality estimation according to color of boiled <i>kombu</i>	116
1.5. Relation between quality and thickness of the plant blade	117
1.6. Conclusions	119
2. Factors determining the quality of <i>Laminaria japonica</i>	119

3. Relation between quality of <i>kombu</i> and quantity of extractive nitrogen	123
4. Relation between quality of <i>kombu</i> and amino acid composition of the extractive ..	125
5. Effect of glutamic acid on preference of <i>kombu</i> extractive	131
6. Conclusions	133
Summary	133
Literature cited	134

INTRODUCTION

Factors influencing the quality of sea food are herein discussed. For this study three typical kinds of samples were chosen: (1) fifteen species of fresh flatfish from Hakodate in Hokkaido, Japan, (2) dried skipjack, so-called *katsuwo-bushi*, and (3) an edible seaweed belonging to *Laminariaceae*, *kombu*. They are typical or unique entities of sea food in Japan.

The general plan of these observation was as follows: first, the quality of samples was estimated objectively and completely in so far as possible. Secondly, the factors affecting the quality were studied quantitatively, as they have previously been explained only qualitatively by some researchers¹⁾. Finally, the relations between the quality as determined first and the factors that appear to influence the quality were compared statistically. If a relation proves to exist statistically, it is regarded as being a factor influencing the quality.

Even though there are many published studies concerning the quality of food, most of them lack a scientific approach. According to the author's experience, a definition for fish freshness, or that for the quality of fish samples based on their freshness is very difficult to formulate. It can be said that many researchers have been studying sea food quality without an accepted definition for the quality. Actually, so far as the present study is concerned, the freshness of fish is so changeable that it is impossible to register precisely the degree of freshness. As all the samples of fish studied here were fresh, the term "quality" as considered in this paper concerns mainly flavor, and sometimes only taste; consequently the vague subjective definition of "quality" based only on the freshness of fish can be eliminated.

The present remarkable progress of stochastics or statistics has rendered studies of food preference scientific and easy. Various papers concerning improvements of methods of judging food preference have been published²⁻⁶⁾. Chromatographic analyses of amino acids and nucleotides, nucleosides and purine bases have likewise made marked progress during the past ten years. Improved methods of microbiological assay for amino acids have also been very helpful in this investigation. Some of these compounds appear to be so closely related to a good taste that studies on food preference have been accelerated by these objective methods.

The present study consists of three parts. Part 1 is concerned with studies of fresh fish quality using fifteen species of flatfish. Only fresh fish were employed as samples in order to simplify the factors involved. So, no consideration was given to the freshness of a sample in this study. In Part 2, *katsuwo-*

bushi (dried skipjack) is studied as a representative of processed fish in which boiling, sun-drying, smoking, and inoculation of molds are combined skilfully during the course of processing. In Part 3, a study is described of one of the edible seaweeds, *kombu*, which is an important item in the Japanese diet.

The latter two materials, *katsuwo-bushi* and *kombu*, are used as seasonings or dominant ingredients of soups in traditional and typical Japanese dinners. The white meat of flatfish has a rather typical fishy taste, while the dark meat resembles the flesh of domestic animals in flavor. Thus the flatfish is suitable for the study of typical fishy tastes and flavors.

The above mentioned two seasonings have been investigated extensively in Japan; monosodium glutamate known by its trade-name "Aji-no-moto" was found⁷⁾ to be contained in the seaweed, *kombu*, in considerable quantities, while inosinic acid which is becoming popular as one of the chemical seasonings in Japan was isolated⁸⁾ from *katsuwo-bushi*. Both of these compounds are very tasty; they are economically important as chemical products in Japan. The relations between these compounds and the qualities of the foods have already been studied by the author in collaboration with Prof. K. Murata and others. Some of the conclusions reached have been published⁹⁻¹²⁾. However, there still remain many problems to be thoroughly investigated in respect to the relations between the qualities and chemical characteristics of these foods. So the present research has been carried out to study these relationships.

Acknowledgement by the author is due to Prof. Kiichi Murata, of the Faculty of Fisheries, Hokkaido University, for his constant encouragement and valuable advice throughout the course of the present study. He also expresses gratitude to Miss Yuko Tamura for her kind assistance in various ways. The author is indebted to Dr. H. Ohmi, Assistant Prof. of Phycology, of Hokkaido University, for his useful suggestions concerning this research and manuscript. He feels grateful to Messrs. A. Iida, A. Fuji, K. Sato, K. Sasaka, E. Kanai and A. Oyamatsu and Miss A. Okumura for their help in experiments and calculations. Cordial thanks are offered to Prof. W. B. Esselen, Head of the Department of Food Technology, University of Massachusetts, U.S.A., to Prof. W. Simidu, of the Department of Fisheries, Faculty of Agriculture, Kyoto University and to Mr. George Kudo, research staff of Commercial Fisheries, Fish and Wildlife Service, U.S.D.I., U.S.A., for their kindness in reading through the original manuscript.

PART I. QUALITY OF FRESH FISH MEAT AS REPRESENTED BY FLATFISH

1. Fifteen species of flatfish from Hakodate

In studying whether a certain property is related to quality or not, one should examine many kinds of samples in order to test the relation. Fortunately fifteen species of flatfish are commonly sold at fish markets in the Hakodate district and are easy to obtain. The difference in quality according to species

is very large; some species are so poor in quality that they are rarely eaten even when very fresh, while some are excellent in taste. The common names of these flatfish in this district and their scientific names are shown in Table 1.

Table 1. Common Japanese and scientific names of flatfish from Hakodate

Common Japanese name	Scientific name
<i>Hirame</i>	<i>Paralichthys olivaceus</i> (TEMMINCK & SCHLEGEL)
<i>Ohyō</i>	<i>Hippoglossus stenolepis</i> SCHMIDT
<i>Ma-garei</i>	<i>Limanda</i> sp.
<i>Matsukawa</i>	<i>Verasper moseri</i> JORDAN & GILBERT
<i>Mizukusa</i>	<i>Eopsetta grigorjewi</i> (HERZENSTEIN)
<i>Ishi-garei</i>	<i>Kareius bicoloratus</i> (BASILEWSKY)
<i>Baba-garei</i>	<i>Microstomus achne</i> (JORDAN & STARKS)
<i>Asaba</i>	<i>Lepidopsetta mochigarei</i> SNYDER
<i>Aka-garei</i>	<i>Hippoglossoides dubius</i> (SCHMIDT)
<i>Kawa-garei</i>	<i>Platichthys stellatus</i> (PALLAS)
<i>Nameta</i>	<i>Glyptocephalus stelleri</i> (SCHMIDT)
<i>Sōhachi</i>	<i>Cleisthenes pinetorum herzensteini</i> (SCHMIDT)
<i>Suna-garei</i>	<i>Limanda punctatissima</i> (STEINDACHNER)
<i>Same-garei</i>	<i>Clidoderma asperrimum</i> (TEMMINCK & SCHLEGEL)
<i>Abura-garei</i>	<i>Atheresthes evermanni</i> JORDAN & STARKS

Table 2. Spawning season, edible and fine meats, and fatness of flatfish from Hakodate

Fish name	Spawning season	Edible meat	Fine meat	Fatness
<i>Hirame</i>	June ~ July*	64.1%	48.5%	9.9
<i>Ohyō</i>	May ~ June*	70.4	55.8	10.5
<i>Ma-garei</i>	Feb. ~ Mar.	69.4	51.0	13.8
<i>Matsukawa</i>	Nov. ~ Jan.	66.1	48.5	14.5
<i>Mizukusa</i>	May ~ June	62.8	45.9	10.3
<i>Ishi-garei</i>	Feb. ~ Mar.*	60.8	40.7	11.5
<i>Baba-garei</i>	Mar. ~ Apr.	63.6	45.6	11.7
<i>Asaba</i>	Dec. ~ Jan.	61.4	41.8	13.5
<i>Aka-garei</i>	Feb. ~ Apr.	67.3	45.4	9.3
<i>Kawa-garei</i>	Oct. ~ Jan.	66.4	36.9	14.6
<i>Nameta</i>	May ~ June	71.5	50.4	8.0
<i>Sōhachi</i>	Apr. ~ July	58.7	39.8	10.5
<i>Suna-garei</i>	May ~ July	64.3	42.8	10.9
<i>Same-garei</i>	Apr. ~ May**	42.1	31.1	14.1
<i>Abura-garei</i>	Jan. ~ Feb.**	64.7	45.9	8.9

* From Hikita's paper ** From a paper by *Suisan-cho*

The respective catches in 1953 were as follows: *Ma-garei*, 57,650; *hirame*, 51,540; *ishi-garei*, 41,080; *aka-garei*, 47,350; *baba-garei*, 56,000; *nameta*, 41,250; *sōhachi*, 50,300; *matsukawa*, 2,550; *asaba*, 8,050; *sun-garei*, 7,900; *mizukusa*, 650; *same-garei*, 500 (Unit: *kan* which is equivalent to 3.75 kg).

The spawning season of these flatfish, their edible meat content, the ratio of fine meat (for raw steak preparation) to body weight and average fatness during twelve months (computed by dividing body weight by the cubic value of total length) are shown in Table 2. These items are compared later with the quality of flatfish. In the column "spawning season" shown in Table 2, an asterisk indicates reference to Hikita's paper¹³⁾ while double asterisks indicate data obtained from a paper¹⁴⁾ published by the *Suisan-cho*, Fisheries Agency, Ministry of Agriculture and Forestry, Government of Japan.

Fish meat is commonly consumed after preparation in one of three ways: raw fish steak, broiled over a charcoal fire, or boiled with soy sauce. Certain species of flatfish are delicious when they are cooked after sun-drying, while others are used only in the form of a fish-paste cake called *kamaboko*, otherwise those species possess no value as food. Each of the fifteen species has its own best method of preparation. These methods are surveyed and shown in Table 3; later those methods are also considered in comparison of the quality.

Table 3. Results of a survey on the most suitable method of preparing flatfish

Fish name	Number of answers	Percentage of answers favoring:				
		raw steak	charcoal-broiled	boiled with soy sauce	dried	other methods
<i>Hirame</i>	73	94.5	0.7	2.7	2.1	0.0
<i>Ohyō</i>	67	85.3	2.0	3.7	3.0	6.0
<i>Ma-garei</i>	74	9.4	32.3	58.0	0.3	0.0
<i>Matsukawa</i>	58	59.5	10.3	30.2	0.0	0.0
<i>Mizukusa</i>	67	12.6	44.7	32.7	8.6	0.0
<i>Ishi-garei</i>	72	36.3	13.9	47.9	1.2	0.7
<i>Baba-garei</i>	71	4.5	7.0	86.6	1.9	0.0
<i>Asaba</i>	56	1.8	31.3	59.8	7.1	0.0
<i>Aka-garei</i>	61	12.2	23.1	53.5	10.9	0.3
<i>Kawa-garei</i>	58	42.8	16.1	39.4	1.7	0.0
<i>Nameta</i>	66	3.0	24.2	25.0	47.0	0.8
<i>Sōhachi</i>	70	8.6	45.5	13.4	31.5	1.0
<i>Sun-garei</i>	60	0.0	42.2	53.1	4.7	0.0
<i>Same-garei</i>	60	16.1	12.8	44.4	12.5	14.2
<i>Abura-garei</i>	42	12.7	0.0	2.4	24.6	60.3

Hakodate is famous as a fishing port; it is well equipped with many fish processing, canning and refrigerating plants. The inhabitants of this city are supplied with various kinds of fish in abundant quantities and they are very familiar with fish foods. Accordingly their criticism of fish taste is well refined. As many as fifteen species of flatfish are distinguished and evaluated commonly

by these well-trained citizens. With such a background, it may be said that Hakodate is a very suitable place to carry on such a project as the present one.

2. Quality evaluation of the flatfish

The fifteen species of fish were evaluated in three ways: First, they were ranked according to the wholesale market price ratio (2.1); secondly, the results of sensory tests were analysed statistically (2.2); next, statistical analyses were made on inquiries into the taste of flatfish (2.3). Finally, the results of these different ways were analysed statistically¹⁵⁾. By the analysis, no significant difference among these sets of data were found. The detailed procedures are described below (2.4).

2.1. Price ratio

Before using data on fish prices, one should prudently consider the price itself because it is generally regarded as changeable and as not truly reflecting a standard of quality. In the present study, even the price may be taken as representing a standard of fish quality if the wholesale price ratio is treated carefully. The price data used here were obtained from records of the Hakodate Wholesale Fish Market in 1951, 1952, and 1953.

The price of fish may change in the course of a day, week, month or year. It may be affected by the amount of catch, the weather conditions, the catch or fishing efforts, the freshness and the manner of treatment of the fish, and lastly, it may be dependent on the species.

The following eight factors seem to be the main causes of variation in fish price. They were studied as follows:

1) Fluctuations in the course of a day are eliminated completely if the wholesale market prices are used, because the market price is customarily set once a day early in the morning.

2) Changes within a week or a month are rather distinguishable, but they can be deminished if the price ratio is used, since the causes of changes by the week or by the month are usually almost the same for each species of flatfish. Therefore the price ratios of the market flatfish versus the standard flatfish of *ma-garei* are not affected by these changes.

3) Annual change exists even though it may be slight because food preferences of the inhabitants of the district gradually change. Such changes are small so they do not affect the accuracy of this research.

4) Table 4 shows the relation between the total amount of catch and the price, using *ma-garei* which is a typical flatfish found throughout Japan. As may be observed in this table the price is affected by the catch in summer and autumn. When the price ratio is used, error due to variation in the amount of catch is decreased, since most of the catches of flatfish decrease similarly.

5) Weather conditions are presumed by the people of Hakodate district to have a marked effect upon the market price, but the author has never observed⁹⁾ any such relationship from records of the market and of the Hakodate Marine Observatory.

Table 4. Significance of correlation between the price and the amount of *ma-garei* in the fish market

	Jan.	Feb.	Mar.	Apr.	May	June	July	Aug.	Sept.	Oct.	Nov.	Dec.
1951	-	-	-		‡	+	+	-	+	+	-	-
1952	-	-	-	-	+	‡	-	+	+	+	-	+
1953	+	-	-	-	‡	‡	-	‡	‡	+	+	+

‡....Highly significant +....Significant -....Insignificant

6) Fishing methods are restricted by the condition of the bottom and tidal currents, therefore the catching efforts may differ a little according to these conditions. However, all the catches are evaluated at one and the same market and any such differences of effort are customarily neglected in this district.

7) Freshness of the fish, size, shape and color become the causes of wide variation in fish price. In the wholesale market register, only the highest and the lowest prices are recorded. An assumption has to be adopted in order to get a mean value from the highest and lowest values, for they may include completely different qualities. When the highest price shows the value as twice that of the lowest one, the qualities of the fish are regarded as being completely different. The highest price multiplied by 0.8 is used as the mean value of good quality. When the highest price is less than twice the lowest one, a simple average is made. Accordingly, the following idea is generally adopted: When the highest price of similar quality samples is less than twice the lowest, these samples are considered to belong in the same category, and when the difference is over this limit the samples are different in quality from each other.

8) The effect on price due to the species is the one that the present author will attempt to determine ultimately.

The price ratios of flatfish to *ma-garei* fish were calculated on the basis of daily records. The ratios were averaged per month for three years, so that price ratios for thirty-six months could be obtained for each of the fourteen species of flatfish except the standard *ma-garei*, excluding the months when fish are not caught in sufficient quantity. Therefore the ratios should be called "average value of monthly price ratio." After calculation of the standard error, the parameter is stochastized at the 5% level. The results are shown in Table 5 and schematically in Figure 1.

The significance of differences among the parameters was studied with conclusions as follows: Significant differences are not found among some few parameters in which the number of samples is small, but differences among the most of the parameters of price ratio are significant.

For several years after World War II fish prices controlled officially so as to reflect the market price. After being calculated, the price ratios from the controlled prices in 1948, were compared with the newly obtained price ratios. Both ratios, old and new, were found to be in close agreement. This proves that they stand on the same base.

Table 5. Monthly average price ratio of flatfish

Fish name	Number of values n	Average value \bar{x}	Standard deviation s	Coefficient of variation C	Parameter m
<i>Hirame</i>	35	1.49	0.363	24.4	1.35—1.62
<i>Ohyō</i>					
<i>Ma-garei</i>	36	1.00			
<i>Matsukawa</i>	17	0.93	.247	26.5	0.80—1.06
<i>Aka-garei</i>	28	.76	.143	18.8	.71— .82
<i>Mizukusa</i>	5	.74	.138	18.7	.57— .91
<i>Baba-garei</i>	30	.68	.135	19.7	.63— .73
<i>Ishi-garei</i>	31	.64	.096	14.9	.61— .68
<i>Kawa-garei</i>					
<i>Asaba</i>	11	.53	.198	37.2	.40— .66
<i>Sōhachi</i>	23	.52	.101	19.5	.47— .56
<i>Nameta</i>	19	.46	.096	21.0	.41— .50
<i>Suna-garei</i>	5	.36	.115	32.0	.22— .50
<i>Abura-garei</i>	3	.27	.138	50.5	— .62
<i>Same-garei</i>	6	.19	.020	10.4	.17— .21

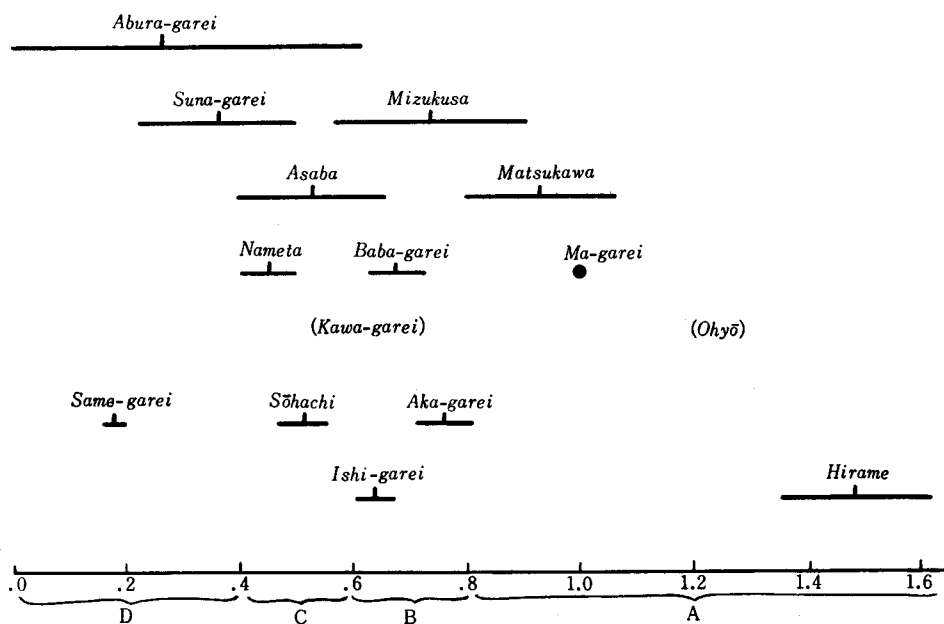

Fig. 1. Showing the price ratio schematically

The fish may be divided into four groups according to the value of the price ratio as following and as shown in Figure 1.

- Group A; *Hirame, ohyo, ma-garei, matsukawa*
Group B; *Aka-garei, mizukusa, baba-garei, ishi-garei*
Group C; *Kawa-garei, asaba, sohachi, nameta*
Group D; *Suna-garei, abura-garei, same-garei*

2.2. Evaluation by sensory test

Tests were conducted seven times. One of them was carried out to ascertain the difference in taste of different parts of the fish body, and another one was done in order to observe the difference in taste if any among different individual fish of the same species. The other five tests were done to learn the differences among species.

One test for change of individual fish bodies was made according to Scheffé's paired comparison¹⁶⁻¹⁹). The other six were done by a new method devised by the present author, viz., in every test a standard fish is divided into two dishes; one is presented as a standard and the other as an unknown fish. This standard fish is presented as an unknown and as a standard, along with a third unknown fish whose rating is to be determined. Definite grades are given according to the degree of preference by the tasters. The comparison of both standards is carried out to ascertain which persons give consistent grades, giving an indication of the accuracy of the judges. A grade of 3 is given when the sample is similar in evaluation to the standard fish. When it is judged a little better or worse than the standard, a grade of 4 or 2 is given respectively to the fish. If the sample is judged very good or very poor in comparison with the standard, a grade of 5 or 1 respectively is given to it. Then the grades are compared by the analysis of the difference between mean values of two groups of samples^{20,21}). The judges were about thirty persons drawn from the staff and students of the Faculty of Fisheries, Hokkaido University and from the Hakodate Nutrition College, in Hakodate City. They may be considered to represent the educated consumers in that city.

All fish samples used in these experiments were freshly taken.

2.2.1. Difference according to body parts

To avoid difference between individual fish, a big *hirame* fish was used. It was prepared as raw fish steak. The meat was divided into six parts, viz., dorsal and abdominal meats on both black and white sides, in other words eye and blind sides, and caudal meat and rim meat on dorsal and anal fins, as shown in Figure 2. The latter meat is also appreciated by Japanese people, being called *engawa*. The dorsal meat of the black side was used as a standard. The average values assigned are as shown in Table 6.

The significance of the differences in these values was studied statistically. According to values at the 5% level of significance the sample meats are divided into two groups; to the better group were assigned dorsal meats on black and white sides and abdominal meats of both sides, while caudal meat and rim meat on fins were assigned to the lower group.

Difference according to parts were found to be slight but it is necessary to be careful in sampling fish meat from various parts of the fish body.

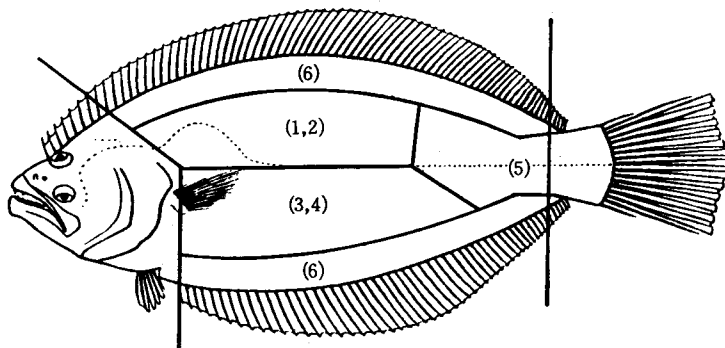

Fig. 2. Showing body parts: (1, 2) Dorsal parts on both eye and blind sides, (3, 4) abdominal parts on both sides, (5) caudal part and (6) rim part on dorsal and anal fins

Table 6. Difference in taste by body parts

Parts of body	Average mark	Significance between the standard and samples
Dorsal part of blind side	3.15	Insignificant at the 20% level
Dorsal part of eye side	3.0	(Standard)
Abdominal part of blind side	2.87	" "
Abdominal part of eye side	2.81	" "
Caudal part	2.52	Significant at the 5% level
Rim part	2.23	Significant at the 1% level

2.2.2. Difference among individuals of the same species of flatfish

It is very desirable to know the degree of fluctuation in quality between individuals. Is there any quality difference among fish of the same appearance? By the "same appearance" is meant: fish of the same size, same freshness, caught on the same fishing ground on the same day by the same fishing method and treated in the same manner until served as a food after the same cookery. For this study three species and for each species five fish were used: Three male and two female *hirame* fish before spawning season for raw fish steak, five female *ma-garei* fish in spawning season for broiling on charcoal, four males and one female of *baba-garei* fish after spawning for boiling with soy sauce. These methods of preparation, respectively, are favorites as shown in Table 3. The pieces of meat were intermixed well to avoid distinction due to recognition of difference of fish parts. Scheffé's paired comparison method was used, but many judges had complained of giving grades based on just one test. So in this case the tests were repeated again and again until the judges were satisfied with their gradings. Therefore the effect according to the testing order in the original method cannot be computed. After calculation of the main effects, they were summarized in Table 7. Through the analysis of variance, it was shown that the values for broiled *ma-garei* and for boiled *baba-garei* fish differ significantly.

Table 7. Value of main effects in testing of individual change in taste

	<i>Hirame</i>	<i>Ma-garei</i>	<i>Baba-garei</i>
α_1	.007	.07	.173
α_2	.069	.31	.104
α_3	.035	-0.14	-0.370
α_4	-0.042	-0.20	.116
α_5	-0.055	.05	-0.024

This means that there were individual differences within the latter two samples of fish. Further, the differences were calculated by Tukey's method¹⁹⁾ and the following conclusions were reached: One group of *hirame* fish, three groups of *ma-garei* fish and also three groups of *baba-garei* were found to have detectable differences in their flavor. The difference between male and female fish was not distinct in this experiment.

In conclusion, generally a slight fluctuation in quality exists among individuals in a group of fish although they are similar in appearance. In testing the taste of fish this "individual difference" is always a serious matter. It is necessary to be cautious and take note of this fact in every case.

2.2.3. Difference according to species

Five tests were carried out. In each test, fish were prepared for eating in the three above-mentioned most popular styles, viz., as raw fish steak, by broiling on charcoal and by boiling in soy sauce. The sample fish was compared with the standard and then grades were given to the sample according to the present author's method. The grades were calculated by an analysis of variance among fish species and among judges. The results from this analysis are shown in Table 8. If the results are ideal, a distinct difference among the species of fish and no difference among the judges should be found to exist. To know the accuracy of the evaluations by the present judges, another calculation was carried out in comparing two "standards," one was identified as a standard while the other was not; it was shown that the judges were quite consistent. From these two studies, it may be said that the results were approximately ideal.

Table 8. Analysis of variance among fish and judges (S, Br and Bo mean methods of preparation: raw fish steak, broiled on charcoal and boiled with soy sauce, respectively.)

	1st Expt.			2nd Expt.			3rd Expt.			4th Expt.			5th Expt.		
	S	Br	Bo	S	Br	Bo	S	Br	Bo	S	Br	Bo	S	Br	Bo
Fish	++	++	++		++	++	++	++	++	++	++	++	++	++	++
Judges	+		++				+						++	++	

++ Significant at the 1% level + Significant at the 5% level

The grades for all the fish species were calculated by the analysis of difference between two mean values chosen at random. According to the significance at the 5% level, two species of flatfish in a pair optionally chosen were qualified as comparatively better or worse or as similar in quality to each other. Putting the fish in quality order, the results of 5 experiments were summarized into a rating of each different three preparations. A numerization in the range of zero to ten was possible for each fish in each 3 gradings. The raw fish steak preparation was appreciated most highly while the boiled fish meat was evaluated lowest among the three methods of preparation by the judges from among the district consumers. Methods of preparation were weighted according to public opinion: weight 5 was given to the raw fish steak method, weight 3 to the method of broiling on a charcoal fire, and weight 2 was given to the meat boiled with soy sauce. Thus the following Table 9 was made up.

Table 9. Sum of marks in taste-testings

Raw fish steak		Broiled on charcoal		Boiled in soy sauce	
<i>Hirame</i>	50	<i>Mizukusa</i> <i>Matsukawa</i>	29	<i>Matsukawa</i> <i>Mizukusa</i>	19
<i>Ma-garei</i>	45	<i>Ma-garei</i>	24	<i>Ma-garei</i> <i>Hirame</i>	
<i>Mizukusa</i> <i>Matsukawa</i>	40	<i>Hirame</i> <i>Ishi-garei</i>		<i>Asaba</i> <i>Ishi-garei</i>	14
<i>Ishi-garei</i> <i>Asaba</i>	35	<i>Aka-garei</i> <i>Asaba</i>	18	<i>Aka-garei</i> <i>Baba-garei</i>	
<i>Baba-garei</i>	30	<i>Baba-garei</i> <i>Kawa-garei</i>		<i>Kawa-garei</i>	10
<i>Nameta</i> <i>Aka-garei</i>	25	<i>Nameta</i>	12	<i>Nameta</i>	8
<i>Kawa-garei</i>	20	<i>Sōhachi</i> <i>Same-garei</i>	9	<i>Sōhachi</i> <i>Same-garei</i>	5
<i>Sōhachi</i>	15	<i>Abura-garei</i>	3	<i>Abura-garei</i>	2
<i>Abura-garei</i> <i>Same-garei</i>	7				

Combining the ratings based on methods of cooking, fish quality evaluated by sensory test was expressed numerically; The rating scale ran from zero to 100 with the ideal fish getting a total score of 100. Thirteen species of flatfish were thus distinguished into four groups according to distinct differences between their total scores, i.e., the fish which scored more than 87 fell into the first group, the fish with scores from 67 to 57 were in the second group, those from 48 to 29 were in the third group while those which scored less than 20 were in the fourth group. They were as follows:

1st group; *Hirame* (87), *ma-garei* (88), *matsukawa* (88), *mizukusa* (88), *ohyō*

2nd group; *Ishi-garei* (67), *asaba* (67), *baba-garei* (62), *aka-garei* (57)

3rd group; *Kawa-garei* (48), *nameta* (45), *sōhachi* (29)

4th group; *Same-garei* (19), *abura-garei* (15), *sunagarei*

Ohyō and *sunagarei* were not included in these tests. Their positions, however, can be inferred to be in the first and the fourth groups, respectively, with reference to the others according to price ratio and consumer survey.

2.3. Analysis of consumer survey

Questionnaires were distributed to the following persons: A, scholars—8 persons; B, wholesale fish dealers—8; C₁, fish retailers from pre-war days—6; C₂, retailers of fish since World War II—13; D, chefs in restaurants and hotels—; E₁, fishermen in Sumiyoshi-cho—; E₂, fishermen in Yamasedomari—7; E₃, fishermen in Mori—10; E₄, fishermen in Moheji—5; E₅, fishermen in Toi—5; and F, housewives—6, total 80 persons in all. They were all living in the Hakodate district. These persons were interviewed and questioned individually by the author and assistants. The questionnaires citing fifteen species of fish were checked by the persons noted above according to their knowledge of the quality of these fish. The quality ranks returned by them were averaged per group and the average rank was compared with each rank by Spearman's rank correlation method^{22,23}. No ranks were eliminated by the statistical procedure. These average ranks are shown in Table 10 except for those of the housewives because they claimed to have insufficient knowledge to attempt to rank the fish. The average ranks per group were statistically the same with each other. They were further averaged and a quality rank is presented as below:

- (1) *Hirame*, (2) *magarei*, (3) *babagarei*, (4) *ohyō*, (5, 6) *matsukawa* and *ishigarei*, (7) *mizukusa*, (8) *sōhachi*, (9) *akagarei*, (10) *kawagarei*, (11) *nameta*, (12) *asaba*, (13) *sunagarei*, (14) *samegarei*, (15) *aburagarei*

Table 10. Survey of consumer's preference

Group of consumer	A	B	C ₁	C ₂	D	E ₁	E ₂	E ₃	E ₄	E ₅	Total	Order
<i>Hirame</i>	1	1	1	1	1	1	2	1	1	1.5	11.5	1
<i>Ohyō</i>	3	4.5	9	3	2	6	7	3	3	4	44.5	4
<i>Magarei</i>	2	6	2	2	3	3	4.5	2	2	3	29.5	2
<i>Matsukawa</i>	4	4.5	4	6.5	4	14	6	4	7	10	64	5.5
<i>Akagarei</i>	7	7.5	10	8	10	7	10	6	13	9	87.5	9
<i>Mizukusa</i>	12	3	7.5	5	5	8	1	7	8	8	64.5	7
<i>Babagarei</i>	5	2	3	4	7	2	4.5	9	5.5	1.5	43.5	3
<i>Ishigarei</i>	6	10	5.5	9	6	4.5	9	5	4	5	64	5.5
<i>Asaba</i>	11	12	13	11.5	13	9	14	12	9	11	115.5	12
<i>Sōhachi</i>	10	9	7.5	6.5	8	4.5	3	8	10	6	72.5	8
<i>Kawagarei</i>	8	11	12	13	9	10	11	11	5.5	7	97.5	10
<i>Nameta</i>	9	7.5	5.5	10	11	12	8	10	12	13	98	11
<i>Sunagarei</i>	14	13	11	11.5	12	14	12.5	13	11	12	124	13
<i>Aburagarei</i>	15	15	15	15	15	14	15	15	14.5	15	148.5	15
<i>Samegarei</i>	13	14	14	14	14	11	12.5	14	14.5	14	135	14

2.4. Discussion

The fifteen species of flatfish were judged for quality by different methods described above and as shown in Table 11, but the three ranks were somewhat different from each other. It was necessary to ascertain whether the fifteen species of flatfish were evaluated under the same concepts and standards. Therefore their relations were examined as follows:

Table 11. Calculation for significance among the three ranks of quality of flatfish; A, rank based on price ratio, B, rank on sensory test and C, rank on consumer survey

	A	B	C	Total	Total ²	A ²	B ²	C ²
<i>Hirame</i>	1	3	1	5	25	1	9	1
<i>Ohyō</i>	2	3	4	9	81	4	9	16
<i>Ma-garei</i>	3	3	2	8	64	9	9	4
<i>Matsukawa</i>	4	3	5.5	12.5	156.25	16	9	30.25
<i>Aka-garei</i>	5	7.5	9	21.5	462.25	25	56.25	81
<i>Mizukusa</i>	6	3	7	16	256	36	9	49
<i>Baba-garei</i>	7	7.5	3	17.5	306.25	49	56.25	9
<i>Ishi-garei</i>	8	7.5	5.5	21	441	64	56.25	30.25
<i>Asaba</i>	9	7.5	12	28.5	812.25	81	56.25	144
<i>Sōhachi</i>	10	11	8	29	841	100	121	64
<i>Kawa-garei</i>	11	11	10	32	1024	121	121	100
<i>Nameta</i>	12	11	11	34	1156	144	121	121
<i>Suna-garei</i>	13	14	13	40	1600	169	196	169
<i>Abura-garei</i>	14	14	15	43	1849	196	196	225
<i>Same-garei</i>	15	14	14	43	1849	225	196	196
Total	120	120	120	360	10928	1240	1221	1239.5
						3700.5		

$$W = \frac{S_B}{S_{BV}}$$

where

S_B = between method variation

S_{BV} = total variation

W = coefficient of concordance

$$F_0 = \frac{(m-1)W}{1-W}$$

$$n_1 = (n-1) - \frac{2}{m}$$

$$n_2 = (m-1) \left\{ (n-1) - \frac{2}{m} \right\}$$

$$m=3, n=15$$

$$\frac{T^2}{N} = \frac{360^2}{3 \times 15} = 2880$$

$$S_{BV} = 3700.5 - 2880 = 820.5$$

$$S_B = \frac{10923}{3} - 2880 = 761$$

$$W = \frac{761}{820.5} = 0.9274$$

$$F_0 = \frac{(3-1) \times 0.9274}{1-0.9274} = 25.547$$

$$n_1 = (15-1) - \frac{2}{3} = 13.33$$

$$n_2 = (3-1) \left\{ (15-1) - \frac{2}{3} \right\} = 26.66$$

$$F_{26.66}^{13.33}(0.01) \doteq 2.66$$

Therefore,

$$F_0 > F$$

Thus it is obvious that the three ranks ordered by the different methods are not significantly different. This means that the results from these three methods can be regarded as very similar as a whole, although they are slightly different.

2.5. Conclusions

The ranks from the sensory tests among the three methods, are principally used in the following Part 1, (3), since the rank is based on judgments made by the test panel.

3. Factors determining quality of the flatfish

3.1. Relation between quality and characteristics, ecological and morphological

As the quality rank has been determined in Part 1, (2) above, next, factors determining the quality were studied. Consideration was first given to ecological and morphological characteristics, which seem to exert some effect upon the quality of the fifteen species of flatfish. The basic common ideas suggested by Uchida²⁴), on which the present author based this study are as follows: The fish mainly inhabiting northern waters and having their spawning seasons almost entirely in winter, are sometimes considered preferable in winter in the opinion of people living in northern Japan. On the contrary, however, the southern fish with spawning season in summer, are considered to be more delicious in summer than in other seasons. The food habits, fatness and quantity of edible parts of the fish are often thought to be closely related to the quality, represented by price.

The characteristics were graded on the following bases:

1) To the group which spawns in winter a value of 1 was given; to the group which spawns in spring a value of 2 was given, and to the summer group a value of 3 was given.

2) To the group whose food is mainly other fish a value of 1 was given, and the fish which commonly eat large crustaceans were given a value of 2. Lastly to the eaters of small crustaceans and annelids, a value of 3 was given.

3) To the fish which are found only in northern Japan as far south as Muroran a value of 1 was given, fish which occur as far south as Choshi were given a value of 2, fish which occur in all parts of Japan from Sōya to Kagoshima were given a value of 3.

Fish which live only in water shallower than two hundred meters depth were given a value of 1, for the sake of convenience, while those which live in water both deeper than the former and at the same depth were given value of 2.

4) A suggestion for a method of determining the degree of fatness and the ratio of the edible parts to the body weight of fish by a numerical categorization has been made.

The characteristics were determined as follows:

1) Quality—The conclusions reached in Part 1, (2) above were used as showing the quality of fish.

2) The spawning season shown in Table 2 was used for this consideration.

3, 4) Horizontal and vertical distributions—Both sets of data are taken from Kuronuma's investigation²⁵⁾.

5) Food habits—Under this subject, the stomach contents, ratio of length of maxilla to body length, ratio of intestinal length to body length, number of

Table 12. Ecological and morphological features of flatfish: Quality according to sensory test (1), spawning season (2), horizontal distribution (3), vertical distribution (4), food habits (5), fatness (6) and edible parts (7)

	(1)	(2)	(3)	(4)	(5)	(6)	(7)
<i>Hirame</i>	3	12.5	12.5	10	2.5	12	9
<i>Ohyō</i>	3	12.5	1.5	2.5	2.5	10	2
<i>Ma-garei</i>	3	7	12.5	10	13.5	4	3
<i>Matsukawa</i>	3	2.5	6	2.5	8	2	6
<i>Mizukusa</i>	3	12.5	12.5	10	8	11	11
<i>Ishi-garei</i>	7.5	7	12.5	2.5	8	7	13
<i>Baba-garei</i>	7.5	7	12.5	10	13.5	6	10
<i>Asaba</i>	7.5	2.5	6	10	8	5	12
<i>Aka-garei</i>	7.5	7	6	10	2.5	13	4
<i>Kawa-garei</i>	11	2.5	6	2.5	8	1	5
<i>Nameta</i>	11	12.5	6	10	13.5	15	1
<i>Sōhachi</i>	11	12.5	6	10	8	9	14
<i>Suna-garei</i>	14	12.5	1.5	10	13.5	8	8
<i>Same-garei</i>	14	7	12.5	10	8	3	15
<i>Abura-garei</i>	14	2.5	6	10	2.5	14	7

Table 13. Spearman's "rs" of ecological and morphological characteristics, in comparison with quality of flatfish

	Spawning season	Horizontal distribution	Vertical distribution	Food habit	Fatness	Edible part
rs	-0.016	-0.347	0.440	0.196	0.086	0.268
Significance		**				

loops of intestine, ratio of length of gill raker to that of gill arch, shape of gill rakers and that of teeth, and the ratio of length of pyloric caeca to body length and number of pyloric caeca were studied with reference to the researches by M. Hatanaka *et al.*^{26,27)} and P. A. Moiseev²⁸⁾.

6) The data on fatness and ratio of edible parts to the body weight were obtained from Table 2 in Part 1, (1).

In order to analyse the relation between the quality and the above characteristics, after counting number of fish belonging to one and the same grade in respect to one and the same item, the ranks were finally settled. The results of this ranking are shown in Table 12.

Next, use was made of Spearman's rank correlation method. These ranks were compared with the quality rank which had been decided through sensory tests described above in Part 1, (2). The results obtained by this comparison are shown in Table 13.

The following conclusions were drawn from the data exhibited in Table 13: Some of the northern fish which are found as far south as Kagoshima in southernmost Kyushu, are superior to the others in quality. The difference of spawning season, food habits, degree of fatness and ratio of edible parts appeared to have no relation to the quality rating thus estimated.

3.2. Relation between quality and ordinary chemical constituents

Various views on the chemical constituents of fish flesh are prevalent in Japan²⁹⁾. Some of them are as follows:

- 1) The fish is more delicious when it is fatty than when lean.
- 2) Preference for some species of fish changes seasonally; this change is partly due to the variation in the amount of fat.
- 3) The amount of fat varies with the spawning season of the fish.
- 4) An increase in fat is always accompanied by a decrease in moisture content of the fish meat.

In order further to examine the above mentioned points, and moreover to find factors affecting the food quality, viz., the relation between quality and the ordinary constituents (moisture, ash, crude fat and crude protein), this next-described study has been carried out with the use of the flatfish described previously. The results of analyses by the conventional methods are shown in Tables 14 to 28.

Table 14. Results of analysis of chemical constituents of *hirame* (*Paralichthys olivaceus*)

	Total length (cm)	Body weight (g)	Sex	Weight of gonad (g)	Moisture (%)	Ash (%)	Crude fat (%)	Crude protein (%)	Total of average value
1954									
Oct.	34.8	380	F	1.0	80.17	1.17	0.11	18.79	100.43
					80.50	1.22	0.11	18.79	
Nov.	38.0	605	F	3.0	77.46	1.31	1.33	18.91	99.43
					77.82	1.33	1.75	18.94	
Dec.	40.5	895	F	4.0	77.73	1.13	2.23	18.56	99.83
1955					77.96	1.17	2.29	18.59	
Jan.	33.5	380	F	2.0	75.74	1.22	1.13	20.96	99.17
					75.77	1.26	1.21	21.04	
Feb.	40.5	585	F	5.5	73.05	1.25	1.89	22.41	98.92
					73.35	1.27	2.19	22.42	
Mar.	44.0	415	F	7.3	77.43	1.31	2.05	18.84	99.79
					77.66	1.34	2.18	18.86	
Apr.	32.0	365	F	1.4	78.28	0.93	0.14	20.04	99.63
					78.36	1.25	0.15	20.11	
May	41.7	725	M	4.8	78.41	1.21	0.79	20.19	100.83
					78.49	1.22	0.87	20.47	
June	37.8	530	F	1.4	78.91	1.01	0.43	19.73	100.18
					78.95	1.16	0.43	19.74	
July	38.3	560	F	2.6	76.62	1.21	0.81	21.99	100.83
					76.88	1.33	0.81	22.01	
Aug.	38.8	585	F	2.5	76.60	1.20	0.17	22.34	100.43
					76.63	1.24	0.20	22.44	
Sept.	36.5	470	F	2.1	77.91	1.27	0.11	21.05	100.39
					77.96	1.28	0.12	21.08	

Table 15. Results of analysis of chemical constituents of *ohyō* (*Hippoglossus stenolepis*)

	Total length (cm)	Body weight (g)	Sex	Weight of gonad (g)	Moisture (%)	Ash (%)	Crude fat (%)	Crude protein (%)	Total of average value
1954									
Oct.	62.5	2600	F	12.0	76.90	1.02	1.58	19.88	99.40
					76.93	1.02	1.59	19.88	
Nov.									
Dec.									
1955									
Jan.	39.5	675	F	2.3	79.87	1.28	0.12	19.03	99.17
					79.89	1.40	0.12	19.09	
Feb.	43.0	780	F	3.0	78.90	1.35	0.12	19.42	99.93
					78.99	1.48	0.18	19.42	
Mar.	57.0	1980	F	11.2	79.60	0.94	0.17	18.45	99.49
					79.88	0.95	0.18	18.80	
Apr.	67.0	3375	F	18.0	77.95	1.24	0.67	20.66	100.59
					78.05	1.24	0.71	20.66	
May	71.0	3750	F	24.7	79.53	1.29	0.34	19.41	100.30
					79.59	1.32	0.35	19.52	
June	65.0	2740	F	2.7	78.70	1.36	0.69	19.98	100.85
					78.71	1.39	0.72	20.15	
July									
Aug.									
Sept.									

Table 16. Results of analysis of chemical constituents of *ma-garei* (*Limanda sp.*)

	Total length (cm)	Body weight (g)	Sex	Weight of gonad (g)	Moisture (%)	Ash (%)	Crude fat (%)	Crude protein (%)	Total of average value
1954									
Oct.	32.0	530	F	4.5	77.29	1.24	1.53	19.35	99.67
					77.77	1.25	1.56	19.35	
Nov.	38.0	895	F	17.0	77.82	1.25	1.04	19.25	99.45
					77.84	1.39	1.06	19.25	
Dec.	38.7	1018	F	58.3	76.80	1.27	1.96	19.41	99.78
1955					76.90	1.28	2.06	19.88	
Jan.	34.0	425	F	35.0	80.01	1.00	1.34	16.86	99.32
					80.13	1.01	1.36	16.93	
Feb.	34.5	635	F	117.0	79.60	1.11	0.67	18.15	100.00
					80.17	1.24	0.76	18.29	
Mar.	45.0	1245	F	363.0	83.57	0.93	0.59	14.38	99.72
					83.71	0.97	0.62	14.66	
Apr.	39.5	715	F	24.1	82.92	1.00	0.25	15.22	99.67
					82.95	1.13	0.63	15.24	
May	32.4	435	F	32.8	79.36	1.07	0.47	18.36	99.34
					79.44	1.08	0.50	18.39	
June	34.6	625	F	2.1	79.42	1.27	0.40	18.49	99.79
					79.55	1.32	0.42	18.70	
July	37.0	550	F	132.4	81.17	1.01	0.38	17.59	100.42
					81.42	1.02	0.46	17.79	
Aug.	30.9	325	M	1.7	79.29	1.07	0.57	19.34	100.63
					79.50	1.09	0.84	19.55	
Sept.	30.3	415	F	2.0	77.38	1.30	0.19	21.17	100.18
					77.50	1.33	0.32	21.17	

Table 17. Results of analysis of chemical constituents of *matsukawa* (*Verasper moseri*)

	Total length (cm)	Body weight (g)	Sex	Weight of gonad (g)	Moisture (%)	Ash (%)	Crude fat (%)	Crude protein (%)	Total of average value
1954									
Oct.	34.0	625	F	2.0	79.23	0.98	1.91	17.76	99.93
					79.29	0.99	1.93	17.76	
Nov.	46.0	1370	M	49.5	76.76	1.04	3.87	18.14	99.93
					76.95	1.07	3.87	18.15	
Dec.	40.0	995	F	2.5	74.64	0.93	9.57	14.70	100.13
1955					74.80	0.95	9.82	14.84	
Jan.	34.0	510	F	2.0	79.49	1.10	1.10	18.30	100.08
					79.49	1.18	1.11	18.39	
Feb.	35.5	630	F	3.0	79.45	1.14	1.43	18.09	100.23
					79.56	1.14	1.47	18.18	
Mar.	35.0	650	F	2.4	79.49	1.15	0.93	17.70	99.49
					79.70	1.15	1.10	17.75	
Apr.	40.0	915	F	4.5	79.77	1.16	0.57	18.63	100.20
					79.77	1.23	0.59	18.68	
May	34.5	560	F	3.0	79.97	1.18	0.20	18.49	99.79
					80.03	1.18	0.23	18.50	
June	32.8	585	F	2.6	80.15	0.72	0.60	18.08	100.20
					80.24	0.77	0.63	18.23	
July	36.9	635	F	0.7	80.80	0.92	0.67	18.09	100.63
					80.84	0.98	0.67	18.28	
Aug.	28.3	345	F	0.8	79.93	1.04	0.42	18.72	100.29
					80.02	1.10	0.50	18.84	
Sept.	35.7	635	M	0.3	78.27	1.21	1.02	19.84	100.44
					78.34	1.25	1.03	19.91	

Table 18. Results of analysis of chemical constituents of *mizukusa (Eopsetta grigorjewi)*

	Total length (cm)	Body weight (g)	Sex	Weight of gonad (g)	Moisture (%)	Ash (%)	Crude fat (%)	Crude protein (%)	Total of average value
1954									
Oct.	31.0	254	F	3.0	77.10 77.10	1.22 1.23	2.07 2.13	19.73 19.73	100.16
Nov.	31.8	450	F	10.0	74.31 74.39	1.27 1.27	3.30 3.40	21.10 21.33	100.19
Dec.	32.5	405	F	2.0	78.48 78.72	1.03 1.06	3.03 3.05	17.06 17.17	99.80
1955									
Jan.	36.5	480	F	35.0	78.63 78.79	1.11 1.12	2.09 2.10	17.83 17.89	99.78
Feb.									
Mar.	33.5	370	F	25.7	78.00 78.14	0.92 0.92	2.16 2.22	18.07 18.12	99.28
Apr.	32.0	270	F	13.4	79.16 79.45	1.02 1.04	0.85 1.07	18.89 18.89	100.14
May	36.6	565	F	100.6	78.90 79.01	1.21 1.28	0.29 0.30	19.67 19.75	100.21
June	33.1	350	M	45.7	77.72 77.74	1.21 1.24	1.00 1.14	20.65 20.79	100.75
July	29.3	230	F	0.9	75.27 75.27	1.20 1.23	1.94 2.02	21.32 21.43	99.90
Aug.	28.6	245	F	1.3	75.15 75.22	1.26 1.26	1.33 1.41	22.87 22.90	100.70
Sept.	30.0	265	F	7.5	79.00 79.16	1.05 1.14	0.70 0.83	19.09 19.17	100.07

Table 19. Results of analysis of chemical constituents of *ishi-garei (Kareius bicoloratus)*

	Total length (cm)	Body weight (g)	Sex	Weight of gonad (g)	Moisture (%)	Ash (%)	Crude fat (%)	Crude protein (%)	Total of average value
1954									
Oct.	32.0	455	F	10.0	79.34 79.48	1.05 1.28	1.32 1.54	18.05 18.05	100.06
Nov.	32.5	375	M	10.0	75.14 75.26	1.28 1.30	5.61 5.78	18.89 19.06	101.16
Dec.	34.0	470	F	10.0	80.56 80.87	1.08 1.09	0.70 0.81	16.72 16.77	99.30
1955									
Jan.	37.0	575	F	6.0	79.96 80.17	1.24 1.30	1.23 1.26	18.23 18.27	100.83
Feb.	26.8	211	F	0.1	79.02 79.07	1.20 1.21	0.89 0.94	18.57 18.64	99.87
Mar.	24.5	198	F	1.1	79.56 79.63	1.16 1.17	0.22 0.24	18.06 18.17	99.16
Apr.	38.0	500	F	7.8	82.78 82.80	1.20 1.20	0.06 0.07	15.80 15.86	99.90
May	44.8	790	F	14.3	83.63 83.67	1.18 1.19	0.41 0.45	15.21 15.33	100.56
June	38.0	680	F	4.8	79.07 79.21	1.36 1.37	0.67 0.78	18.35 18.37	99.59
July	39.0	668	M	1.3	77.16 77.23	1.15 1.18	2.31 2.33	19.38 19.43	100.09
Aug.	34.4	530	F	0.4	76.37 76.46	1.12 1.37	1.21 1.30	20.99 21.36	99.90
Sept.	41.2	900	F	8.3	76.58 76.62	1.32 1.44	0.80 0.91	21.40 21.49	100.28

Table 20. Results of analysis of chemical constituents of *baba-garei* (*Microstomus achne*)

	Total length (cm)	Body weight (g)	Sex	Weight of gonad (g)	Moisture (%)	Ash (%)	Crude fat (%)	Crude protein (%)	Total of average value
1954									
Oct.	43.3	478	F	4.0	78.77	0.97	3.19	17.16	100.33
					79.03	0.97	3.41	17.16	
Nov.	41.0	790	F	9.9	79.14	1.13	2.04	16.50	99.47
					79.23	1.14	2.69	17.03	
Dec.	34.0	475	F	5.0	82.35	0.98	0.99	15.45	99.92
1955					82.35	0.98	1.17	15.56	
Jan.	34.0	400	F	4.5	77.39	0.91	5.12	16.37	99.97
					77.60	0.93	5.13	16.48	
Feb.	28.0	208	F	1.3	79.21	0.98	2.07	16.17	98.76
					79.24	1.26	2.11	16.48	
Mar.	38.0	595	F	74.0	84.30	0.94	0.49	14.01	100.01
					84.59	0.98	0.52	14.18	
Apr.	33.8	475	F	63.0	82.50	0.96	0.81	15.51	99.89
					82.55	0.99	0.82	15.63	
May	38.0	650	F	10.5	82.01	0.75	1.64	15.50	100.01
					82.03	0.82	1.77	15.50	
June	40.0	980	F	8.7	80.00	0.90	1.56	18.00	100.62
					80.14	0.99	1.62	18.03	
July	40.7	795	F	8.4	78.71	1.07	0.98	18.89	99.92
					78.95	1.13	1.04	19.06	
Aug.	37.5	605	F	19.8	78.64	1.01	2.00	17.60	99.56
					78.68	1.05	2.51	17.62	
Sept.	30.6	385	M	2.0	79.00	0.82	0.79	18.88	99.71
					79.07	1.05	0.83	18.98	

Table 21. Results of analysis of chemical constituents of *asaba* (*Lepidopsetta mochigarei*)

	Total length (cm)	Body weight (g)	Sex	Weight of gonad (g)	Moisture (%)	Ash (%)	Crude fat (%)	Crude protein (%)	Total of average value
1954									
Oct.	37.5	575	F	15.0	79.65	1.07	1.94	17.90	100.63
					79.73	1.08	1.98	17.90	
Nov.	37.5	705	M	30.0	78.14	1.01	2.34	16.88	98.90
					78.82	1.02	2.44	17.16	
Dec.	41.2	1000	F	200.0	77.03	0.98	5.13	16.80	100.33
1955					77.39	0.99	5.23	17.10	
Jan.	32.5	495	F	93.0	80.92	0.23	2.01	16.15	99.65
					81.36	0.29	2.08	16.25	
Feb.	34.0	540	F	6.0	79.15	1.23	1.32	17.77	99.63
					79.27	1.36	1.44	17.82	
Mar.	30.0	305	M	5.0	78.57	0.90	1.19	17.71	98.58
					78.61	0.94	1.28	17.95	
Apr.	37.0	550	F	14.6	81.85	1.04	0.50	16.31	100.00
					82.09	1.14	0.75	16.31	
May	36.5	695	F	24.6	79.57	0.93	0.96	18.15	99.75
					79.71	1.00	0.98	18.19	
June	37.3	785	F	26.3	78.56	0.93	1.47	19.49	100.49
					78.57	0.94	1.48	19.56	
July	41.0	975	F	39.8	77.87	0.90	0.47	21.10	100.45
					77.92	1.03	0.47	21.14	
Aug.	25.8	188	F	1.1	78.86	1.01	0.49	19.45	99.90
					78.94	1.01	0.49	19.54	
Sept.	32.3	450	F	25.1	79.66	0.83	1.00	18.39	100.07
					79.75	0.91	1.15	18.44	

Table 22. Results of analysis of chemical constituents of *aka-garei* (*Hippoglossoides dubius*)

	Total length (cm)	Body weight (g)	Sex	Weight of gonad (g)	Moisture (%)	Ash (%)	Crude fat (%)	Crude protein (%)	Total of average value
1954									
Oct.	43.5	913	F	55.0	77.93 78.39	1.12 1.12	2.61 2.72	17.16 17.46	99.26
Nov.	41.0	700	F	42.0	78.30 78.40	0.95 1.00	2.96 2.98	17.81 17.93	100.17
Dec.	34.0	375	F	25.0	79.03 79.11	1.03 1.16	2.28 2.38	17.70 17.85	100.27
1955									
Jan.	37.5	495	F	36.0	79.52 79.85	1.06 1.09	0.94 0.95	18.14 18.20	99.88
Feb.	36.0	400	F	49.0	79.99 80.00	1.06 1.35	1.51 1.64	17.39 17.49	100.12
Mar.	38.5	530	F	49.5	81.09 81.09	0.93 0.99	1.05 1.05	17.25 17.46	100.48
Apr.	43.5	925	F	230.0	79.23 79.28	0.96 0.97	1.17 1.24	18.30 18.30	99.73
May	41.2	720	F	16.1	82.60 82.68	0.89 0.94	0.99 1.00	15.81 15.92	100.42
June	35.7	355	F	6.9	81.05 81.06	0.92 0.93	0.59 0.60	17.57 17.60	100.16
July	33.0	330	F	3.5	79.88 79.89	0.97 1.00	0.56 0.57	18.94 19.05	100.43
Aug.	38.5	485	F	13.4	79.75 80.02	1.01 1.03	0.66 0.68	19.04 19.05	100.62
Sept.	36.0	350	F	7.5	80.46 80.50	0.94 0.98	0.31 0.31	18.83 18.87	100.60

Table 23. Results of analysis of chemical constituents of *kawa-garei* (*Platichthys stellatus*)

	Total length (cm)	Body weight (g)	Sex	Weight of gonad (g)	Moisture (%)	Ash (%)	Crude fat (%)	Crude protein (%)	Total of average value
1954									
Oct.	40.0	980	F	65.0	75.57 75.69	1.00 1.02	4.86 5.02	18.79 18.79	100.37
Nov.									
Dec.	38.0	865	F	55.0	77.30 77.38	1.08 1.11	5.59 5.65	16.80 16.95	100.93
1955									
Jan.	43.5	1290	F	177.0	73.55 73.95	1.12 1.12	6.20 6.37	18.25 18.61	99.59
Feb.	27.0	285	F	2.0	76.61 76.94	1.09 1.10	4.79 4.84	17.31 17.39	100.04
Mar.	31.0	410	F	3.0	78.16 78.28	1.16 1.19	2.50 2.56	17.57 17.59	99.51
Apr.	37.0	600	M	25.3	76.22 76.45	1.07 1.09	6.11 6.23	15.87 15.87	99.46
May	33.3	540	F	0.4	80.62 80.73	1.03 1.08	1.11 1.18	17.82 17.86	100.72
June	49.0	1465	F	55.2	80.01 80.12	1.14 1.14	1.59 1.64	17.37 17.42	100.22
July	48.7	1775	F	55.0	77.53 77.56	1.12 1.19	1.10 1.15	20.47 20.57	100.35
Aug.	29.4	328	F	2.0	79.87 80.02	0.82 0.93	0.74 0.74	17.99 18.09	99.60
Sept.									

Table 24. Results of analysis of chemical constituents of *nameta* (*Glyptocephalus stelleri*)

	Total length (cm)	Body weight (g)	Sex	Weight of gonad (g)	Moisture (%)	Ash (%)	Crude fat (%)	Crude protein (%)	Total of average value
1954 Oct.	28.9	163	F	4.0	79.61	1.05	1.71	16.67	99.14
					79.65	1.10	1.82	16.67	
Nov.	30.5	235	F	9.0	79.31	1.05	1.37	17.52	99.36
					79.45	1.06	1.43	17.52	
Dec.	29.5	185	F	4.6	80.51	0.90	2.11	16.37	100.14
1955 Jan.	28.5	240	F	40.8	80.84	0.90	2.26	16.44	
					76.42	1.16	0.46	21.71	99.87
Feb.	29.0	180	F	1.5	76.51	1.24	0.52	21.73	
					80.85	1.06	1.05	16.20	99.37
Mar.	33.0	310	F	15.2	81.24	1.07	1.06	16.21	
					81.58	0.92	0.81	16.24	99.70
Apr.	29.4	155	F	1.4	81.61	0.97	1.01	16.25	
					80.42	0.95	0.29	18.07	99.83
May	34.9	565	F	61.2	80.49	0.95	0.29	18.19	
					79.28	1.09	1.81	17.84	100.13
June	39.6	477	F	39.1	79.38	1.12	1.82	17.92	
					83.92	0.76	0.65	14.49	99.93
July	34.7	290	F	9.7	83.96	0.79	0.65	14.63	
					83.08	0.87	1.86	15.05	100.92
Aug.	28.3	165	F	4.8	83.12	0.91	1.86	15.13	
					80.36	0.59	0.56	18.33	100.01
Sept.	28.7	195	F	0.8	80.38	0.75	0.65	18.39	
					79.02	0.87	1.48	18.41	100.84
					79.08	0.89	1.50	18.42	

Table 25. Results of analysis of chemical constituents of *sōhachi* (*Cleisthenes pinetorum herzensteini*)

	Total length (cm)	Body weight (g)	Sex	Weight of gonad (g)	Moisture (%)	Ash (%)	Crude fat (%)	Crude protein (%)	Total of average value
1954 Oct.	25.8	170	F	0.0	79.74	1.10	3.24	16.13	100.49
					79.76	1.16	3.72	16.13	
Nov.	29.5	270	F	0.0	78.55	1.09	2.62	17.20	99.64
					78.72	1.12	2.65	17.33	
Dec.	36.4	525	F	24.0	75.95	1.01	5.23	17.25	99.54
1955 Jan.	32.0	330	F	8.2	76.05	1.04	5.29	17.25	
					78.03	1.08	4.32	16.47	99.95
Feb.	35.0	445	F	28.5	78.08	1.11	4.39	16.52	
					79.85	1.07	1.78	17.55	100.33
Mar.	34.0	445	F	31.5	79.86	1.09	1.84	17.61	
					76.54	1.31	4.67	17.22	100.02
Apr.	33.7	390	F	37.5	76.63	1.32	4.93	17.44	
					79.63	0.98	0.96	18.05	99.85
May	30.0	260	F	8.1	79.70	0.98	1.18	18.22	
					78.65	0.51	1.27	17.41	98.94
June	33.3	435	F	95.0	79.51	0.97	1.99	17.56	
					81.06	0.93	1.40	17.19	100.66
July	34.2	360	F	43.2	81.07	0.94	1.56	17.22	
					78.96	0.99	1.63	18.30	99.99
Aug.	30.0	295	F	7.1	78.96	1.02	1.69	18.43	
					79.03	0.88	1.15	18.72	100.02
Sept.	31.9	305	F	6.4	79.12	0.97	1.20	18.97	
					80.62	0.95	1.37	17.11	100.26
					80.68	0.96	1.49	17.34	

Table 26. Results of analysis of chemical constituents of *sunu-garei* (*Limanda punctatissima*)

	Total length (cm)	Body weight (g)	Sex	Weight of gonad (g)	Moisture (%)	Ash (%)	Crude fat (%)	Crude protein (%)	Total of average value
1954									
Oct.	23.7	183	F	3.0	73.62	0.95	6.69	17.12	98.58
					73.64	0.96	6.76	17.42	
Nov.	24.6	168	F	4.3	79.08	1.05	1.28	17.00	98.58
					79.33	1.09	1.29	17.01	
Dec.	30.5	340	F	2.5	83.41	0.90	0.50	14.54	99.54
1955					83.78	0.90	0.51	14.44	
Jan.	27.5	215	F	10.0	78.19	0.98	4.45	16.46	100.13
					78.21	1.02	4.47	16.47	
Feb.	24.3	166	F	9.6	79.36	1.08	1.39	18.09	100.22
					79.68	1.12	1.48	18.23	
Mar.	23.5	115	M	0.3	82.77	1.06	0.90	15.23	100.07
					82.87	1.07	0.92	15.31	
Apr.	22.5	110	M	0.7	80.74	1.03	0.49	17.72	100.17
					80.80	1.08	0.50	17.98	
May	31.3	372	F	64.5	80.79	0.96	2.96	15.53	100.33
					80.91	0.96	2.96	15.59	
June	27.8	225	F	20.3	81.85	0.79	0.38	17.09	100.34
					82.03	0.89	0.43	17.22	
July	28.4	220	F	30.8	78.65	0.92	1.93	18.23	99.95
					78.77	0.94	1.93	18.53	
Aug.	22.6	120	F	0.85	79.67	1.11	0.76	18.62	100.45
					80.00	1.13	0.93	18.68	
Sept.	19.93	88	F	0.6	79.20	1.01	1.07	18.68	100.20
					79.23	1.06	1.19	18.79	

Table 27. Results of analysis of chemical constituents of *same-garei* (*Clidoderma asperrimum*)

	Total length (cm)	Body weight (g)	Sex	Weight of gonad (g)	Moisture (%)	Ash (%)	Crude fat (%)	Crude protein (%)	Total of average value
1954									
Oct.	36.8	805	F	1.0	73.18	1.00	10.09	15.54	99.96
					73.28	1.03	10.29	15.54	
Nov.	42.5	1210	F	26.0	62.21	0.75	25.29	11.36	99.67
					62.29	0.79	25.29	11.36	
Dec.									
1955									
Jan.	32.0	535	F	0.0	72.24	0.92	10.08	15.91	99.58
					72.77	0.96	10.33	15.95	
Feb.	19.3	105	F	0.2	81.06	1.11	0.42	15.81	98.52
					81.10	1.17	0.48	15.88	
Mar.	25.5	235	F	0.0	81.52	0.97	1.04	15.69	99.35
					81.65	1.04	1.04	15.74	
Apr.	26.8	240	F	0.0	79.27	1.02	0.88	17.88	99.23
					79.27	1.02	1.17	17.95	
May	43.5	920	F	23.0	82.60	0.93	1.88	14.30	99.79
					82.64	0.95	1.88	14.39	
June	40.0	790	M	5.0	77.99	1.06	2.03	18.93	100.25
					78.33	1.07	2.11	18.97	
July									
Aug.									
Sept.									

Table 28. Results of analysis of chemical constituents of *abura-garei* (*Atheresthes evermanni*)

	Total length (cm)	Body weight (g)	Sex	Weight of gonad (g)	Moisture (%)	Ash (%)	Crude fat (%)	Crude protein (%)	Total of average value
1954									
Oct.	56.5	1785	F	25.0	75.67 75.81	0.87 0.92	8.41 8.47	15.46 15.78	100.70
Nov.									
Dec.	39.5	600	F	5.0	79.70 80.01	0.92 0.98	3.15 3.32	15.90 16.13	100.11
1955									
Jan.	35.5	470	M	1.3	79.32 79.32	0.97 1.12	2.89 2.96	16.77 16.88	100.12
Feb.	40.0	615	F	3.5	75.03 75.48	1.04 1.04	8.24 8.33	16.19 16.20	100.78
Mar.	30.0	245	F	0.8	80.42 80.45	1.00 1.04	1.30 1.33	16.67 16.81	99.51
Apr.	36.0	440	F	1.8	78.49 78.61	0.96 1.03	2.45 2.81	17.14 17.41	99.45
May	30.3	192	F	0.7	80.73 80.89	0.73 0.77	0.55 0.62	17.57 17.75	99.81
June	38.6	510	F	0.8	78.11 78.12	0.88 0.92	4.19 4.29	17.08 17.20	100.40
July	39.2	510	F	0.0	79.63 79.66	1.02 1.02	2.12 2.36	17.99 18.08	100.94
Aug.									
Sept.	29.0	190	F	0.7	80.93 80.94	1.05 1.05	0.82 0.91	17.53 17.53	100.38

The mean values of resulting from analyses of the fifteen species above employed for a twelve-month period are shown in Table 29. The results may be summarized as follows: moisture 79%, ash 1%, crude fat 2%, and crude protein 18%.

Regarding the fat content, it has been observed that it decreases in the spawning season, and also from spring to summer, followed by an increase during autumn to winter.

The degree of variation of the ordinary chemical constituents during twelve months is indicated by means of the coefficient of variance, C^{22} , in Table 29. The value of C for fat content is the largest among the four components. Generally speaking because of the relatively low fat content of the flatfish, it cannot be concluded that the moisture content varies in counterbalance to the amount of fat. The occurrence of this phenomenon is ascertained by calculating the coefficient of correlation (r) among moisture, crude fat and crude protein, for each species respectively. The coefficients were calculated as shown in Table 30.

In respect to the relation between the quality and the ordinary chemical constituents, values (r_s) are obtained by use of Spearman's method, as shown in Table 31; the fish rich in protein are supreme in quality, while those rich in fat are inferior. The amount of moisture content has no relationship with the quality.

Table 29. Average value (\bar{x}), 95% confidence interval ($s\sqrt{\frac{t}{n}}$) and coefficient of variation (C) of chemical constituents

	Moisture			Ash			Crude fat			Crude protein		
	\bar{x}	$s\sqrt{\frac{t}{n}}$	C	\bar{x}	$s\sqrt{\frac{t}{n}}$	C	\bar{x}	$s\sqrt{\frac{t}{n}}$	C	\bar{x}	$s\sqrt{\frac{t}{n}}$	C
<i>Hirame</i>	77.45	0.97	1.97	1.22	0.07	8.90	0.98	0.53	84.77	20.35	0.88	6.83
<i>Ohyō</i>	78.82	1.11	1.64	1.24	0.14	12.31	0.54	0.49	97.42	19.60	0.50	2.74
<i>Ma-garei</i>	79.65	1.32	2.60	1.16	0.06	7.79	0.84	0.32	60.32	18.20	1.21	10.45
<i>Matsukawa</i>	79.04	1.18	2.35	1.07	0.06	8.87	1.89	1.68	14.11	18.08	0.74	6.47
<i>Mizukusa</i>	77.48	2.16	4.16	1.15	0.10	12.90	1.75	0.64	54.09	19.70	1.19	9.00
<i>Ishi-garei</i>	79.15	1.72	3.42	1.23	0.95	6.67	1.33	0.95	112.78	18.36	0.62	9.79
<i>Baba-garei</i>	80.23	1.36	2.67	0.99	0.06	9.14	1.89	0.83	68.94	16.74	0.96	9.01
<i>Asaba</i>	79.25	0.87	1.74	0.95	0.16	27.11	1.61	0.82	79.75	18.06	0.94	8.16
<i>Aka-garei</i>	79.97	0.67	1.33	1.02	0.05	8.36	1.33	0.18	20.69	17.88	0.60	5.30
<i>Kawa-garei</i>	77.63	2.04	2.85	1.08	0.09	11.11	3.50	1.63	64.94	17.87	0.88	6.91
<i>Nameta</i>	80.42	2.48	4.86	0.96	0.10	16.92	1.21	0.41	53.03	17.27	1.18	10.79
<i>Sōhachi</i>	78.95	1.07	2.13	1.03	0.10	15.67	2.57	0.96	58.75	17.45	0.39	3.49
<i>Suna-garei</i>	79.03	1.75	3.45	1.00	0.77	12.06	1.93	1.22	99.12	17.09	0.87	7.99
<i>Same-garei</i>	76.34	5.67	2.47	0.99	0.07	8.54	6.52	7.19	131.90	15.70	1.92	14.62
<i>Abura-garei</i>	78.87	1.39	10.61	0.97	0.05	6.88	3.48	2.01	80.55	16.91	0.48	33.96
Average	78.82			1.07			2.09			17.95		

Table 30. Correlation coefficient (r) among moisture, crude fat and crude protein

	Moisture—fat		Fat—protein		Protein—moisture	
<i>Hirame</i>	-0.537	(-)	-0.241		-0.823	(-)
<i>Ohyō</i>	-0.763	(-)	0.710	(+)	-0.730	(-)
<i>Ma-garei</i>	-0.534	(-)	0.202		-0.951	(-)
<i>Matsukawa</i>	-0.853	(-)	-0.869	(-)	0.600	(+)
<i>Mizukusa</i>	-0.257		-0.153		-0.420	(-)
<i>Ishi-garei</i>	-0.623	(-)	0.308		-0.860	(-)
<i>Baba-garei</i>	-0.644	(-)	0.057		-0.713	(-)
<i>Asaba</i>	-0.402	(-)	-0.449		-0.474	(-)
<i>Aka-garei</i>	-0.805	(-)	-0.302		-0.472	(-)
<i>Kawa-garei</i>	-0.827	(-)	-0.426	(-)	-0.079	
<i>Nameta</i>	-0.028		-0.355	(-)	-0.465	(-)
<i>Sōhachi</i>	0.730	(-)	-0.711	(-)	0.072	
<i>Suna-garei</i>	-0.534	(-)	-0.052		0.169	
<i>Same-garei</i>	-0.981	(-)	-0.743	(-)	0.602	(+)
<i>Abura-garei</i>	-0.998	(-)	-0.859	(-)	0.744	(+)

Table 31. Coefficient of rank correlation (rs) between quality of flatfish and chemical constituents

	Moisture	Ash	Crude fat	Crude protein
rs	-0.052	0.484	-0.503	0.850
Significance				**

In this and the following discussions, analytical results were checked with the individual variation. The basic common methods are as follows: In considering the seasonal variation of fat content of some species, data both individual and seasonal were changed as both the average values become 100. Then the data were adopted in the following equation.

The equation on the marginal abandonment (1)

$$\bar{X} \pm s \sqrt{\frac{n+1}{n} F_{n-1}^{-1}(\alpha)} = K \quad (1)$$

where, s ...standard deviation
 \bar{X} ...average value
 n ...number of samples

is multiplied by the value $\frac{100}{\bar{X}}$, and an equation (2)

$$100 \pm \frac{S \times 100}{\bar{X}} \sqrt{\frac{n+1}{n} F_{n-1}^{-1}(\alpha)} = K' \quad (2)$$

is obtained. Here in equation (2), the first group 100 corresponds to average value, while the second group is the value of marginal abandonment of the high and low. From the data on individual variation of fat content, the value of the second group in equation (2) was calculated.

When some data in the seasonal series of determination were so large that they rose above the range of normal individual fluctuation, they were regarded as being irregular.

3.3. Relation between quality and amount of connective tissue

Though some effect of connective tissue upon the taste has been suggested by several research workers³⁰⁻³², their actual data did not present a clear picture, because the "taste" and the "toughness" of the foods were not distinctly defined.

The present author has studied the relation between the quality and the amount of connective tissue of fish meats. In this case, the quality ranks which had already been proposed were used in place of taste, and the amount of connective tissue was taken into the consideration rather than toughness.

The connective tissue was estimated quantitatively as follows: Homogenized fish meat was pipetted and digested with a pancreatic solution in phosphate buffer at pH 7.0, 30°C, for 5 hours. After being collected by centrifugation, the residue was heated under a pressure of 20 pounds per square inch for 2

hours. Next it was extracted with 2% trichloroacetic acid solution. The extract thus obtained was regarded as the gelatine converted from collagen. The residue from which the gelatine was removed was regarded as elastin. These quantitative results were expressed as nitrogen milligram per cent of raw meat. The sum of collagen and elastin was considered to be the connective tissue, and the ratio of collagen to elastin (c/e) was calculated. The results are shown in Table 32.

Table 32. Ranks on the basis of the quality (q), collagen-N (c), elastin-N (e), connective tissue (ct), ratio of collagen to elastin (c/e) and utilization (u)

	q	c	e	ct	c/e	u
<i>Hirame</i>	3	2	1	1	8	3
<i>Ohyō</i>	3	3	12	3	9	3
<i>Ma-garei</i>	3	10	3	7	11	10
<i>Matsukawa</i>	3	15	4	13	13.5	3
<i>Mizukusa</i>	3	9	9	11	7	6
<i>Ishi-garei</i>	7.5	14	6	14	11	10
<i>Baba-garei</i>	7.5	6	7	5.5	4.5	10
<i>Asaba</i>	7.5	11	5	9	11	10
<i>Aka-garei</i>	7.5	5	8	5.5	4.5	10
<i>Kawa-garei</i>	11	8	10	12	6	3
<i>Nameta</i>	11	1	13	2	1	14.5
<i>Sōhachi</i>	11	4	11	4	3	3
<i>Suna-garei</i>	14	12	2	10	13.5	10
<i>Same-garei</i>	14	7	14	18	2	10
<i>Abura-garei</i>	14	13	15	15	15	14.5

By means of Spearman's rank correlation method, the collagen, elastin, connective tissue and (c/e) were compared by the use of both the quality rank of flatfish and the three methods of preparation of flatfish. The results thus obtained are shown in Table 33. From it the following conclusions were induced: The quality has no significant difference in connection with the main methods of preparation and with the elastin content at approximately the five per cent level, while the others had no relation with the quality at this level. Moreover, the

Table 33. Rank correlation (rs) among the quality (q), collagen-N (c), elastin-N (e), connective tissue (ct), ratio of collagen to elastin (c/e) and utilization (u)

	q-c	q-e	q-ct	q-c/e	q-u	u-c	u-e	u-ct	u-c/e
rs	0.110	0.498	0.285	-0.121	0.544	0.387	0.454	0.218	0.101
Significance					*				

deviation of individuals, with respect to the connective tissue and (c/e) was about ten per cent as a coefficient of variance.

3.4. Relation between quality and amount of acid-soluble phosphorus

The rapid deterioration occurring usually in the taste of white meat fish such as cod, flatfish and others is well known in comparison with tuna or domestic animals. As compounds in fish muscle connected with such rapid changes in palatability, such high energy phosphates as creatine phosphate, adenine triphosphate and so on are noteworthy. It seemed desirable to ascertain whether these high energy compounds have their own good taste or have the ability to delay alteration in palatable substances or palatable conditions. These high energy substances are often identified as the acid soluble organic phosphorus ($\Delta 7P$) which is decomposed to inorganic phosphate.

The acid-soluble $\Delta 7P$ and the inorganic phosphorus in the muscle of the fifteen species of flatfish were determined twice as shown in Table 34, by use of the usual standard method³³). Even in the freshest sample in the market, the greater part of the organic phosphorus in the muscle had disappeared; it seemed with release of its energy to have changed to the inorganic form.

Table 34. Acid soluble phosphorus in flatfish (mg per 100 g fresh meat)

	February		March	
	Inorganic-P	Organic-P	Inorganic-P	Organic-P
<i>Hirame</i>	175	0	140	10
<i>Ohyō</i>	140	0	170	10
<i>Ma-garei</i>	135	0	175	0
<i>Matsukawa</i>	135	0	105	10
<i>Mizukusa</i>			130	0
<i>Ishi-garei</i>	135	10	145	20
<i>Baba-garei</i>	130	0	125	0
<i>Asaba</i>	105	0	150	0
<i>Aka-garei</i>	125	0	125	0
<i>Kawa-garei</i>	130	0	170	0
<i>Nameta</i>	115	0	110	0
<i>Sōhachi</i>	125	0	120	10
<i>Suna-garei</i>	90	0	135	0
<i>Same-garei</i>	105	20		
<i>Abura-garei</i>	130	0	135	0

After comparison of the quality of fish judged in Part 1, (2) with the quantity of inorganic phosphorus ascertained by the Spearman method, a high level of significance ($r_s=0.578$) was found to exist between these two items.

In addition, the individual deviation in respect to acid soluble inorganic phosphorus showed 4.9% as a coefficient of variation.

3.5. Relation between quality and extractive nitrogen

The close relationship between the palatability of meat of many sorts of aquatic animals and quantities of some sorts of extractive nitrogen, has been investigated by certain Japanese researchers¹⁾. To ascertain these relations in flatfish, quantitative estimation were made of the total nitrogen of hot water extractive, mono- and di-amino fractions, so-called humin fraction and trichloroacetic acid precipitates (TCA ppt-N) and also amino nitrogen of mono- and di-amino fractions. The results are shown in Table 35. Then a comparison of

Table 35. Nitrogenous constituents of extractives of *hirame* (1), *ma-garei* (2), *baba-garei* (3), *asaba* (4), *suna-garei* (5) and *same-garei* (N mg per 100 g fresh fish meat)

	(1)	(2)	(3)	(4)	(5)	(6)
Extractive total-N	257 (100)	252 (100)	211 (100)	323 (100)	294 (100)	215 (100)
Mono-amino fraction-N	57 (22)	75 (30)	46 (22)	101 (31)	155 (53)	48 (19)
Di-amino fraction-N	143 (56)	121 (48)	150 (71)	158 (49)	67 (23)	107 (50)
Humin-N	54 (21)	31 (12)	21 (10)	56 (17)	67 (23)	19 (9)
Total	254 (99)	227 (90)	217 (102)	315 (98)	289 (98)	174 (81)
Total amino-N	46 (18)	45 (18)	39 (18)	72 (22)	62 (21)	47 (22)
Mono-amino-N	33 (13)	33 (13)	30 (14)	55 (17)	46 (16)	31 (14)
Di-amino-N	13 (5)	13 (5)	7 (3)	12 (4)	6 (2)	8 (4)
Total	46 (18)	46 (18)	37 (18)	67 (20)	52 (18)	39 (18)
TCA ppt-N	26 (10)	56 (22)	17 (8)	50 (15)	27 (9)	13 (6)

Table 36. Coefficient of rank correlation between the quality and extract nitrogenous constituents

	Extractive total-N	Mono-amino fraction-N	Di-amino fraction-N	Humin-N	Amino total-N
rs	0.136	-0.713	0.500	0.043	-0.414
Significance					
	Mono-amino-N	Di-amino-N	TCA ppt-N	Hot water extractive-N	
rs	0.057	0.867	0.500	-0.127	
Significance					

the fish quality and the quantities of nitrogen estimated in this experiment, was carried out by Spearman's rank correlation method. The results are exhibited in Table 36.

In conclusion, it may be said that only the amount of amino nitrogen of the di-amino fraction is almost statistically related to the quality of flatfish in the rank correlation.

3.6. Relation between quality and amino acid composition of muscle extractive

Even though it is not altogether unimaginable that a close relation may exist between the palatability of foods and the amino acid composition of food extractives, there is no obvious evidence concerning such a relationship. In an attempt to ascertain this relation, flatfish were chosen as samples. However, in the case of flatfish muscle extractive, the characteristics of amino acid composition, e.g., the degree of individual variation, differences among different parts of the fish body, sex, body size, freshness, season, peptide form, habitat and so on, have hitherto been little studied. So, these studies were undertaken from two stand-points: biochemical, and the analysis of palatability.

Seventeen amino acids of thirty-one extractive specimens have been determined through microbiological assay³⁴⁻³⁶). Results of analyses are tabulated in Table 37. The degree of individual variation is shown in Table 38 as coefficients of variation of each amino acid; they are thought to be common to all amino acid compositions in respect to the experimental data presented. Under this assumption, when the difference between two specimens is greater than the

Table 37. Assays of extractive amino acids of *ishi-garei*, *hirame* and *abura-garei*

No. of analysis	(1)	(2)	(3)	(4)	(5)	(6)	(7)	(8)
	Individual change						Eye side	Blind side
Experimental item	1st	2nd	3rd	4th	5th	6th		
Alanine	58.8	51.8	61.2	38.8	28.7	28.3	43.7	41.3
Arginine	8.4	6.0	6.8	4.9	2.4	2.5	6.0	5.4
Aspartic acid	3.0	2.6	2.6	2.4	2.9	2.3	1.2	1.1
Glutamic acid	4.3	9.3	7.7	7.2	3.1	9.6	7.0	7.0
Glycine	10.2	69.0	15.6	50.6	30.7	25.7	27.8	31.4
Histidine	1.9	3.4	2.8	3.5	1.8	3.7	3.1	3.1
Isoleucine	2.2	4.1	3.2	2.8	3.4	4.2	4.4	4.8
Leucine	2.3	1.4	2.9	1.5	2.2	1.3	3.1	3.2
Lysine	31.5	12.7	18.6	10.9	6.5	6.9	17.9	17.1
Methionine	0.45	0.81	0.75	0.57	0.71	1.14	1.4	1.3
Phenylalanine	0.5	1.0	1.8	1.3	0.4	1.1	2.1	2.1
Proline	3.5	8.1	4.7	4.8	6.8	3.8	5.8	6.3
Serine	4.3	17.5	3.9	13.5	15.5	10.0	16.7	16.5
Threonine	14.6	17.6	17.8	15.4	11.0	13.0	10.8	10.5
Tryptophan	0.1	0.4	0.5	0.3	0.3	0.2	0.3	0.4
Tyrosine	0.27	1.15	2.61	1.4	0.35	0.58	1.4	1.8
Valine	3.0	2.9	2.7	3.3	4.2	3.6	4.5	4.7

Table 37—2.

No. of analysis	(9)	(10)	(11)	(12)	(13)	(14)
Experimental item	Fresh			Hydrolyzed		
	Excellent	Good	Slightly deteriorate	Excellent	Good	Slightly deteriorate
Alanine	42.5	38.5	45.7	42.9	39.2	48.1
Arginine	3.6	6.5	0.9	7.7	4.6	3.2
Aspartic acid	1.9	3.5	2.5	9.1	6.4	9.9
Glutamic acid	6.3	11.6	10.5	16.2	12.8	13.9
Glycine	47.2	30.6	35.9	111.0	88.4	68.5
Histidine	3.8	3.6	1.9	3.8	2.7	2.9
Isoleucine	3.9	5.0	5.8	4.1	5.5	7.9
Leucine	2.7	4.1	5.3	4.6	3.1	5.0
Lysine	12.2	11.1	1.5	15.5	11.1	7.3
Methionine	1.4	1.9	1.8	1.5	2.0	2.4
Phenylalanine	2.0	3.4	4.7	3.6	3.6	4.6
Proline	6.2	9.1	11.0	9.1	11.8	16.0
Serine	18.3	15.4	8.3	21.6	18.2	16.2
Threonine	10.3	12.0	6.7	11.4	12.1	9.5
Tryptophan	0.4	0.5	0.7	—	—	—
Tyrosine	1.8	6.7	7.3	3.9	8.7	9.5
Valine	4.5	4.0	5.9	4.3	5.3	7.2

Table 37—3.

No. of analysis	(15)	(16)	(17)	(18)	(19)
Experimental item	Female, middle size	Female, small size	Male, middle size		
			Analyzed in 1955	Analyzed one year later	Hydrolyzed
Alanine	54.9	53.9	49.2	46.5	50.4
Arginine	7.3	8.5	6.9	4.8	4.5
Aspartic acid	1.7	2.1	1.7	1.7	4.8
Glutamic acid	11.2	15.5	13.5	11.4	16.4
Glycine	60.9	62.0	61.7	64.6	82.7
Histidine	3.1	3.1	3.1	3.1	3.2
Isoleucine	8.9	10.6	8.9	9.9	13.3
Leucine	7.9	9.0	7.3	6.3	6.6
Lysine	11.1	17.0	16.1	16.3	17.9
Methionine	2.7	2.9	2.7	2.4	2.4
Phenylalanine	4.0	4.5	3.9	3.4	6.4
Proline	7.1	8.5	7.5	7.8	10.7
Serine	23.3	23.6	24.8	25.4	28.2
Threonine	8.7	9.4	10.2	10.0	10.5
Tryptophan	1.4	1.6	1.4	—	—
Tyrosine	7.8	10.3	8.5	8.8	16.7
Valine	6.2	7.3	5.9	5.8	9.8

Table 37-4.

No. of analysis	(20)	(21)	(22)	(23)	(24)
Experimental item	Female, caught in summer		Male, caught in summer	Female, caught in winter	
		Hydrolyzed			Hydrolyzed
Alanine	30.2	32.1	16.6	20.5	23.7
Arginine	4.0	5.3	8.1	6.8	13.9
Aspartic acid	1.9	3.6	1.7	1.0	12.6
Glutamic acid	5.9	12.7	5.8	9.6	24.3
Glycine	13.0	29.0	15.5	54.2	83.1
Histidine	14.3	14.3	12.3	6.8	6.5
Isoleucine	5.2	8.2	4.2	3.7	3.9
Leucine	2.8	3.6	3.8	2.3	6.2
Lysine	33.0	37.0	16.9	32.3	36.2
Methionine	2.7	2.2	2.0	1.3	3.6
Phenylalanine	1.8	1.8	1.7	1.3	4.4
Proline	12.3	19.3	12.2	5.4	14.7
Serine	8.6	12.1	9.9	8.3	16.7
Threonine	22.7	24.0	13.5	12.4	15.8
Tryptophan	1.0	—	1.4	0.6	—
Tyrosine	2.4	2.4	2.3	2.9	2.1
Valine	4.8	8.1	3.7	2.8	7.4

Table 37-5.

No. of analysis	(25)	(26)	(27)	(28)	(29)	(30)	(31)
Experimental item	Male, caught in winter	Female, caught in spring	Male, caught in spring	Hirame, female, caught in winter		Abura-garei female, caught in winter	
					Hydrolyzed		Hydrolyzed
Alanine	12.8	16.1	18.2	19.0	58.0	20.6	54.2
Arginine	10.2	9.9	8.7	5.9	23.2	2.8	20.5
Aspartic acid	1.8	2.9	2.5	0.7	26.2	1.3	40.2
Glutamic acid	12.9	18.0	10.8	9.8	48.5	9.9	52.8
Glycine	48.0	205	191	16.1	100	19.3	101
Histidine	7.2	9.3	13.8	1.8	1.9	1.7	3.5
Isoleucine	4.0	3.9	3.8	3.1	6.8	3.6	7.4
Leucine	3.5	3.9	3.8	2.5	13.0	1.2	16.4
Lysine	22.0	24.5	24.3	38.9	64.6	13.1	36.0
Methionine	3.6	4.0	5.0	0.9	6.3	0.7	6.0
Phenylalanine	1.7	2.0	1.9	1.3	9.2	1.5	8.9
Proline	7.3	13.7	14.9	3.2	28.6	3.3	22.3
Serine	10.5	20.2	23.7	7.2	24.1	6.5	31.4
Threonine	15.0	12.6	17.5	12.0	20.7	9.0	20.3
Tryptophan	0.2	0.3	0.3	0.4	—	0.3	—
Tyrosine	2.3	3.3	2.9	1.6	0.4	1.9	1.4
Valine	4.4	5.7	4.5	3.1	13.7	3.1	14.7

Table 33. Individual fluctuation of extractive amino acids from six *ishi-garei* fish

Amino Acid	Average value (\bar{x})	Standard deviation s	Coefficient of variation (C)	Parameter (m)
Alanine	44.6	14.7	33	29.2 — 60.1
Arginine	5.2	2.4	46	2.6 — 7.7
Aspartic acid	2.6	0.28	11	2.3 — 2.9
Glutamic acid	6.8	2.7	39	4.0 — 9.6
Glycine	33.6	22.3	66	10.2 — 57.0
Histidine	2.8	0.83	30	1.9 — 3.7
Isoleucine	3.3	0.77	23	2.5 — 4.1
Leucine	1.9	0.64	34	1.2 — 2.6
Lysine	14.5	9.5	65	4.6 — 24.5
Methionine	0.74	0.24	32	0.49 — 1.0
Phenylalanine	1.0	0.52	52	0.44 — 1.5
Proline	5.3	1.8	34	3.4 — 7.2
Serine	10.7	5.7	54	4.7 — 16.7
Threonine	14.8	2.6	18	12.0 — 17.6
Tryptophan	0.3	0.14	48	0.15 — 0.45
Tyrosine	1.1	0.85	77	0.21 — 2.0
Valine	3.3	0.55	17	2.7 — 3.9

degree of individual variation, the two determined values are regarded as different from each other in quantity.

By comparing results on every item, one finds no outstanding characteristics or clear relations. This may be due partly to the large individual variances of amino acid, while in some instances it may be due to the small number of samples.

In conclusion, no relationship could be discerned between the quality and the amino acid composition of extractive of flatfish meat.

In addition, even though the individual fluctuation of lysine content is great, the quantity order of lysine changes with the quality order of flatfish. Di-amino fraction nitrogen in which lysine is included also slightly but statistically increases with the quality order. By a combination of the above two facts, a relationship between the quality and the content of lysine is conceivable.

3.7. Conclusions on factors determining quality of the flatfish

In summary it may be said that the following factors were found to be statistically meaningful in relation to the quality of flatfish from Hakodate:

1) Ecologically, some of the northern flatfish which inhabit also southern waters are superior in quality to the others; dwellers in shallow waters excel the others.

2) As to the chemical constituents, the fatty flatfish are poorer in quality than the lean.

3) The quantity of elastin-nitrogen is closely related to the quality; especially when the nitrogen is rich in fish meat, the meat is suitable for preparation of raw fish steak.

4) Acid soluble inorganic phosphorus has a relation statistically to the quality rank of flatfish.

5) Only the amino-nitrogen of di-amino fraction out of several forms of nitrogen is statistically related to the quality.

6) No relationship is statistically found between the quantity of any kind of amino acid and the quality of the fish.

Some of the above factors may occur accidentally while the others may be quite significant. Though the reason for the existence of these factors has not been clarified as yet, their probable effects are listed as follows, viz., fat content is a negative factor, whilst quantities of elastin-nitrogen, acid soluble phosphorus and amino-nitrogen of di-amino fraction are positive factors.

PART II. QUALITY OF PROCESSED FISH MEAT AS REPRESENTED BY *KATSUWO-BUSHI* (DRIED SKIPJACK)

Katsuwo-bushi is made from fresh skipjack tuna, *Katsuwonus pelamis* (LINNÉ), by a complicated procedure: cutting of course is first (when a big fish is used, it is cut into four pieces longitudinally and is called *hon-bushi*; when a small one is used it is divided into two longitudinal halves called *kame-bushi*); later steps are: boning, boiling with fresh water, sun-drying smoking and inoculation with some cultured special molds. It takes two months to complete the whole process. The product can be preserved for quite a long time without deterioration if rancidity is avoided.

Katsuwo-bushi is principally used to make clear soup called *suimono* in Japanese. Occasionally it is also used for seasoning in *nitsuke*, a kind of hard-boiled food heavily seasoned with soy sauce. The flavors of the two kinds of food are different because the former is seasoned with a light extract from *katsuwo-bushi*, while the latter is made from an exhaustive extract of it. The two extracts are different in flavor because the conditions of extracting are different: the former is extracted lightly whereas the latter is extracted exhaustively. The flavors of the light meat and the dark (blooded) meat of *katsuwo-bushi* are different from each other: the former is delicate, while the latter is somewhat disagreeable in flavor.

Since *katsuwo-bushi* is a type of preserved food, quality evaluation for the present study was made in all parts of Japan, while the evaluation of flatfish was made locally. In the present Part 2, the grades given by the wholesale market specialists are studied to ascertain whether these grades are readily accepted by laymen as a basis for rating *katsuwo-bushi* quality.

As the principal tasty substance of *katsuwo-bushi* has been isolated and identified already⁸⁾ as histidine-inosinate, the quantities of the related compounds of histidine-inosinate, viz., seventeen amino acids, inosinic acid (IMP), adenylic acid (AMP), inosine and hypoxanthine were compared with the rated quality of *katsuwo-bushi*.

1. Samples of *katsuwo-bushi* and preparation of testing liquids

The samples used in this research are listed in Table 39. After having been evaluated for quality, the *katsuwo-bushi* were contributed for these experiments by Mr. S. Takatsu who is an authority on *katsuwo-bushi* in Japan. Tosa, shown in this table, lies in southwestern Japan; it is an area noted for production of good quality *katsuwo-bushi*. Sanriku district is in northeastern Japan where low quality *katsuwo-bushi* is produced. For the present experiment, samples were chosen representative of distinct contrasts of good and poor qualities, as generally considered, in order to make the comparison clear. The judgment of quality, good or poor, was mainly based on tasting of clear soup (*suimono*) made from *katsuwo-bushi*.

Table 39. *Katsuwo-bushi* samples used in the experiments

1st experiment	(1) Tosa, <i>honbushi</i> , high quality (2) Tosa, <i>honbushi</i> , low quality (3) Sanriku, <i>kamebushi</i> , low quality
2nd experiment	(4) Tosa, <i>honbushi</i> , high quality (5) Tosa, <i>honbushi</i> , low quality, lean (6) Tosa, <i>honbushi</i> , low quality, fatty (7) Sanriku, <i>kamebushi</i> , low quality
3rd experiment	(8-13) Tosa, <i>honbushi</i> , high quality, 6 pieces (14-19) Sanriku, <i>kamebushi</i> , low quality, 6 pieces

The quality of the extractives in *suimono* is affected distinctly by the conditions of extraction: extracting time, extracting temperature and the proportion of quantity of *katsuwo-bushi* to the water used for extraction.

The conclusions in regard to the extracting conditions studied¹⁰⁾ were as follows: The liquid extracted for 3 minutes from 3% sliced *katsuwo-bushi* by weight added to boiling water is the most suitable for *suimono*. The extractive used for *suimono* is called *ichiban-dashi*. In addition it should be noted that the re-extractive of the residue is used for another kind of stock called *niban-dashi* which is used for *nitsuke*.

The flavor deteriorates when the dark meat is mixed with the light meat. Therefore, in this research, the two types of meat were divided and extracted separately. In the first experiment, high quality *katsuwo-bushi* from Tosa was extracted slightly for *ichiban-dashi* and then extracted exhaustively for *niban-dashi*. Other samples were extracted exhaustively from the very beginning. So, in those samples, the two kinds of extractives of *ichiban-dashi* and *niban-dashi* were combined. All the extractives in the first experiment, were hydrolyzed in order to ascertain the quantity of combined amino acids.

In Table 40 the sample extractives analyzed in these experiments are listed.

Conditions for the extracting were determined by a panel which consisted of staff and students of the Laboratory of Sea Food Chemistry, Hokkaido Uni-

versity. Before the testing, they were trained to distinguish the good and poor tastes of extractives prepared from the two kinds of *katsuwo-bushi* as graded in the market. A very short training period of about two or three days was enough to enable them to distinguish the quality. The evaluation is fairly easy. One tabulation of testing results is shown in Table 41 to demonstrate the panel's facility and preference.

Table 40. *Katsuwo-bushi* extractive samples

1st experiment	(1) Tosa, high, light meat, <i>ichiban-dashi</i> , free form (2) Tosa, high, light meat, <i>ichiban-dashi</i> , combined form (3) Tosa, high, light meat, <i>niban-dashi</i> , free form (4) Tosa, high, light meat, <i>niban-dashi</i> , combined form (5) Tosa, high, dark meat, <i>ichiban-dashi</i> , free form (6) Tosa, high, dark meat, <i>ichiban-dashi</i> , combined form (7) Tosa, high, dark meat, <i>niban-dashi</i> , free form (8) Tosa, high, dark meat, <i>niban-dashi</i> , combined form (9) Tosa, low, light meat, free form (10) Tosa, low, light meat, combined form (11) Sanriku, low, light meat, free form (12) Sanriku, low, light meat, combined form
2nd experiment	(13) Tosa, high, light meat (14) Tosa, high, dark meat (15) Tosa, low, lean, light meat (16) Tosa, low, fatty, light meat (17) Tosa, low, light meat
3rd experiment	(18-23) Tosa, high, light meat (24-29) Sanriku, low, light meat

Table 41. One of the sensory tests for *katsuwo-bushi* extractives (Code numbers of *katsuwo-bushi* are equivalent to those in Table 39. Letter "D" after the number means dark meat part of *katsuwo-bushi*.)

Code no. of <i>katsuwo-bushi</i>	(4)	(5)	(6)	(7)	(4D)	(5D)	(6D)	(7D)
Ranking scores of panel	1	2	3	4	7	5	6	8
	2	1	3	4	8	6	5	7
	2	1	3	4	8	5	6	7
	1	2	3	4	6	7	8	5
	1	2	3	4	5	6	7	8
	2	2	3	4	5	6	7	8
	2	1	3	4	5	6	7	8
	2	3	1	4	5	6	7	8
	2	3	1	7	5	8	6	4
Sum of scores	14	17	23	39	54	55	59	63

2. Relation between quality of *katsuwo-bushi* and amino acid composition of the extractive

The amino acids contained in the extractive samples, numbered 1 to 12, determined by microbioassay, are shown in Table 42. In view of the results, consideration was made on the following 4 items:

Table 42. Amino acid composition of *katsuwo-bushi* extractives in the 1st experiment (Unit: mg of amino acid per 100 g *katsuwo-bushi*) Code numbers at the top of columns in this table are equivalent to those in Table 40.

Name of extractive Amino acid	(1)	(2)	(3)	(4)	(5)	(6)
	free	combined	free	combined	free	combined
Alanine	80.9	99.3	8.3	56.6	62.8	71.6
Arginine	12.1	85.4	2.0	49.1	9.3	47.3
Aspartic acid	22.2	49.0	1.9	27.7	18.1	27.3
Glutamic acid	36.7	166.8	3.3	94.3	34.8	112.4
Glycine	94.4	254.5	2.2	74.2	54.4	212.3
Histidine	2955	300	227	—	1675	—
Isoleucine	33.2	27.6	4.6	18.4	22.0	19.6
Leucine	42.3	49.9	1.8	32.5	30.8	34.7
Lysine	75.4	135.8	5.5	66.8	41.4	86.7
Methionine	28.7	21.1	1.4	14.1	15.1	21.1
Phenylalanine	24.4	30.9	2.0	19.4	22.1	19.5
Proline	42.2	41.2	6.3	49.0	27.8	43.2
Serine	34.3	100.2	3.4	48.6	19.1	86.4
Threonine	38.0	37.6	3.3	20.4	23.1	31.8
Tryptophan	4.4	—	0.7	—	3.7	—
Tyrosine	31.7	12.0	3.5	15.4	22.4	5.6
Valine	55.3	21.1	4.3	24.0	34.7	17.2

Table 42-2.

Name of extractive Amino acid	(7)	(8)	(9)	(10)	(11)	(12)
	free	combined	free	combined	free	combined
Alanine	10.3	40.0	96.0	100.9	117.5	136.6
Arginine	1.7	33.8	21.4	79.8	27.9	113.0
Aspartic acid	3.4	17.0	20.0	65.2	25.8	101.3
Glutamic acid	6.7	56.9	52.4	212.2	66.3	289.3
Glycine	8.7	98.9	34.9	196.7	36.3	267.4
Histidine	272	—	3448	548	3469	83.2
Isoleucine	5.0	10.0	38.4	30.3	45.2	51.9
Leucine	5.1	19.8	29.9	73.6	41.9	100.8
Lysine	7.8	35.9	107.1	169.4	76.0	232.6
Methionine	2.0	10.1	15.9	19.2	117.8	43.9
Phenylalanine	4.8	11.9	19.5	35.9	30.4	54.4
Proline	5.2	31.8	60.8	67.1	57.5	74.7
Serine	4.5	35.5	38.2	101.3	52.5	165.3
Threonine	4.4	17.0	34.9	40.3	48.9	56.1
Tryptophan	1.0	—	6.4	—	9.4	—
Tyrosine	5.0	4.1	25.9	27.5	35.0	63.1
Valine	6.8	10.5	34.7	47.3	42.7	69.9

1) The three different kinds of qualities of samples; Tosa high quality, Tosa low quality and Sanriku low quality, were ranked as high, medium and low, respectively. No positive relations between the rank in quality and the amounts of amino acids were found. Reversible relations, however, were found in the case of alanine, arginine, glutamic acid, isoleucine and serine in free form, and tyrosine and valine in combined form. As to the other kinds of amino acids, definite relationships were seldom found. These relations are shown schematically in Figure 3.

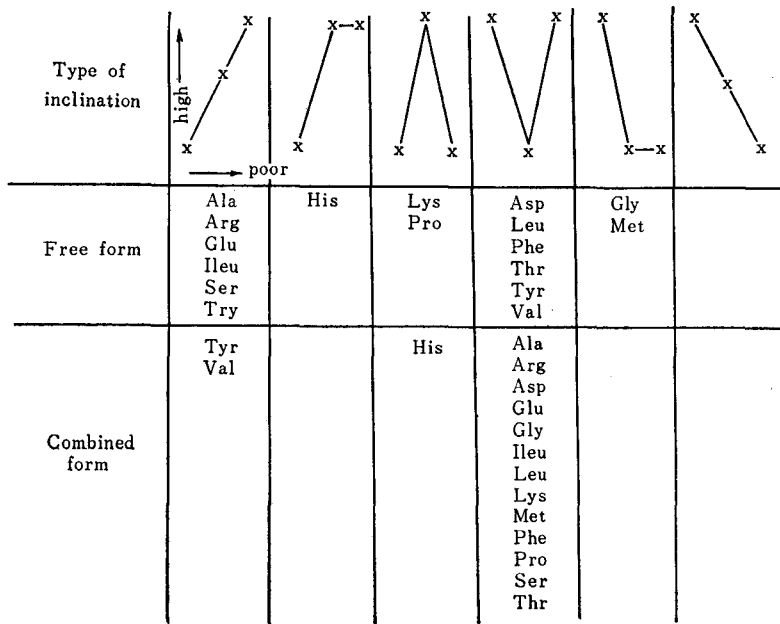

Fig. 3. Schemata showing the relations between the quality of *katsuwo-bushi* as ordinate and the quantity of amino acids as abscissa

Ala Alanine	Ileu Isoleucine	Ser Serine
Arg Arginine	Leu Leucine	Thr Threonine
Asp Aspartic acid	Lys Lysine	Try Tryptophan
Glu Glutamic acid	Met Methionine	Tyr Tyrosine
Gly Glycine	Phe Phenylalanine	Val Valine
His Histidine	Pro Proline	

2) Comparison of *ichiban-dashi* with *niban-dashi*: Light and dark meats were studied. The amino acids contents of *ichiban-dashi* and *niban-dashi* from both light and dark meats of *katsuwo-bushi* were compared. The amino acid contents of *ichiban-dashi* were higher than those of *niban-dashi* in both cases, especially in free form.

3) Comparison of light and dark parts of meat: The light meat contained greater amounts of every amino acid than the dark meat. The flavor of dark meat extractive was weak and poor. It was impossible to improve the taste by concentrating that extractive, because it contains some objectionable flavor.

4) Comparison of free and combined amino acids: Combined forms of amino acids were present in relatively rich amounts in *niban-dashi* of both light and dark meats. No distinct relationship was found between the relative amounts of combined and free forms and the *katsuwo-bushi* quality.

The results of examination of the relationship between the quality and amino acid content were contrary to expectations; many sea food chemists in Japan believe that there is a close relationship between them. The following experiment was carried out using being made of four kinds of samples of different qualities. The samples of extractive used are indicated by numbers 13 to 17 (Table 40). The results determined by microbiassay are shown in Table 43. No distinct relationship was found between content and quality which might explain the reason for good quality *katsuwo-bushi*.

Table 43. Amino acid composition of extractive of *katsuwo-bushi* (Unit: mg of amino acid per 100 g *katsuwo-bushi*) The code numbers correspond to those in Table 40.

Amino acid	(13)	(14)	(15)	(16)	(17)
Alanine	84.0	82.1	91.7	54.9	106.2
Arginine	16.2	9.6	31.8	13.5	39.4
Aspartic acid	18.8	16.8	27.1	15.6	25.2
Glutamic acid	28.3	13.9	45.6	34.2	50.3
Glycine	20.0	14.4	25.5	12.4	21.0
Histidine	3050	961.4	2014	3021	2572
Isoleucine	20.3	17.4	26.7	14.1	23.6
Leucine	40.7	36.6	45.8	16.0	63.0
Lysine	48.2	29.5	67.6	44.5	93.3
Methionine	20.7	14.8	26.2	13.4	27.4
Phenylalanine	22.5	25.5	37.7	14.8	30.4
Proline	219	27.6	22.1	11.7	26.4
Serine	30.9	27.6	36.6	14.9	33.5
Threonine	30.3	21.4	38.6	21.2	39.8
Tryptophan	4.9	2.4	6.4	2.5	5.8
Tyrosine	22.1	13.1	31.3	9.8	21.8
Valine	25.6	28.8	40.9	25.5	53.5

In the above two experiments, only one piece of *katsuwo-bushi* was used as the representative of each quality. A final conclusion can be presented after careful study of individual fluctuation. Thus a third experiment was carried out as follows:

Six pieces each of the same quality *katsuwo-bushi* of Tosa high-quality and Sanriku low-quality were used in the third experiment. By means of column chromatography³⁷⁾ histidine was determined as representing amino acids. Values of 2989, 2669, 2080, 2987, 2480 and 2355 mg per 100 g of good quality (Tosa

high-) and 2209, 2837, 1430, 2329, 2044 and 3405 mg per 100 g of low-quality (Sanriku) *katsuwo-bushi* were found. These data were analysed by scrutinizing the difference of two mean values; no difference was found between the two different quality groups.

In conclusion, it is to be said that the amino acid composition of *katsuwo-bushi* does not appear to be related to its quality. A similar conclusion was reached by Konosu *et al.*^{38,39)}

3. Relation between quality of *katsuwo-bushi* and amounts of nucleotides, nucleoside and purine base

Studies under this heading were made because inosinic acid has been isolated as a tasty compound from *katsuwo-bushi*. The same samples used in the experiments detailed above were used in studies described in this Part 2, (3). The method employed by Saito and Arai⁴⁰⁾ was introduced for analysing these compounds. The experimental results are shown in Table 44. The contents of inosinic acid in the Sanriku poor sample was extremely low as compared with that of other samples. Even when the values of Sanriku were disregarded, no distinct relation was found between the quality estimated by Takatsu and the quantities of these compounds. To check this fact a second experiment was carried out use being made of the same method. The results are also shown in Table 44. In this case likewise, no distinct relation was found between the two sets of results. To ascertain the individual fluctuation of these compounds in the same samples, the sample liquids from Nos. 18 to 29 were analysed. The results showed 350, 334, 274, 476, 419 and 493 mg of inosinic acid in 100 g Tosa

Table 44. Purine base, nucleoside and nucleotides in *katsuwo-bushi* extractives in the 1st and 2nd experiments. Number of extractive is the same as the one shown in Table 40. (mg per 100 g *katsuwo-bush*)

No. of extractive		I+Hyp	AMP	IMP
1st experiment	(1)	413	68	127
	(3)	240	82	98
	(5)	376	104	114
	(7)	242	100	92
	(9)	396	71	279
	(11)	663	44	28
2nd experiment	(13)	423	90	269
	(14)	363	146	140
	(15)	595	82	103
	(16)	141	83	380
	(17)	387	105	225

I....Inosine, Hyp....Hypoxanthine, AMP....Adenosine mono-phosphate (Adenylic acid), IMP....Inosine mono-phosphate (Inosinic acid)

high-quality samples, 140, 118, 61, 79, 104 and 171 mg of inosinic acid in 100 g of Sanriku low-quality samples, 105, 112, 110, 129, 83 and 111 mg of adenylic acid in Tosa high-quality samples and 126, 101, 55, 108, 150 and 101 mg of adenylic acid in Sanriku low-quality samples. Statistical analysis of the data revealed that there is a distinct difference in the amount of inosinic acid present, while no difference is seen in the case of adenylic acid. After three tests the author came to the conclusion that the inosinic acid is occasionally low in low-quality *katsuwo-bushi*; thence the inosinic acid at times may be a factor related to the quality of *katsuwo-bushi*, but this is not always true.

4. Relation between quality of *katsuwo-bushi* and fat content

It has already been found⁴¹⁾ that the fat content of an inferior *katsuwo-bushi* is higher than that of a sample of superior quality. The fat content of the samples used in these experiments and also the moisture and amino nitrogen content were determined. The results, presented in Table 45, show that the fat content was almost completely in accord with the quality rating except for the

Table 45. Chemical constituents of *katsuwo-bushi* sample and extractives (The numbers of the sample are equivalent to those in Table 39. A letter "D" after a sample number means a dark meat part of *katsuwo-bushi*).

Sample No.		Moisture %	Ash %	Crude fat %	Crude protein %	Amino-N mg %
1st experiment	(1)	16.8	3.00	1.21	79.2	463
	(1D)	17.8	2.99	3.00	72.5	345
	(2)	16.3	2.53	6.35	74.5	442
	(3)	14.4	2.73	8.31	74.8	478
2nd experiment	(4)	15.1		3.97		540
	(4D)	15.0		7.25		446
	(5)	13.9		1.78		578
	(6)	14.7		9.18		486
	(7)	14.2		8.22		567
3rd experiment	(8)	15.8		4.46		495
	(9)	15.4		3.87		406
	(10)	14.2		4.15		449
	(11)	14.9		3.99		425
	(12)	14.4		4.33		390
	(13)	16.2		4.03		487
	(14)	14.4		6.80		460
	(15)	15.1		9.32		415
	(16)	13.5		7.39		437
	(17)	14.9		8.24		493
	(18)	16.1		11.05		332
(19)	15.0		9.75		424	

results derived from sample, Tosa-low, lean. These findings are in agreement with those reported by other workers⁴¹⁾.

5. Conclusions

Two components of *katsuwo-bushi* influence its quality. The fat content exerts a negative influence while the inosinic acid content has a positive effect. Because the influence of fat on quality is greater than that of the good taste compound, inosinic acid, the following idea is proposed: The presence of poor flavors or poor conditions in food are always more noticeable than the presence of a good taste or good conditions. So it may be said that a good cooking method should take away or diminish the poor flavors rather than to strengthen the good tastes or conditions, (refer to the analytical results on flatfish in previous part).

PART III. QUALITY OF EDIBLE SEAWEEDS AS REPRESENTED BY THOSE BELONGING TO THE *LAMINARIACEAE*

Seaweeds are appreciated by Japanese as one of their important foods. They have been well known as phycophages from ancient times. *Kombu* is a group of edible seaweeds belonging to the *Laminariaceae*. Under the name *kombu*, various species of seaweeds are included. Each of their common Japanese names usually includes a suffix "-kombu" as shown in Table 46. Most of the *kombu* have become very popular in the world since the world-famous seasoning, monosodium glutamate (M.S.G.) was recognized and isolated from the *kombu* plant by Dr. Ikeda in 1909.

Some important members of the *kombu* groups were studied as reported in this part. Their common names, scientific names⁴²⁾ and annual average yields⁴³⁾

Table 46. Annual yield of common species of *kombu* from Japan

Common name	Scientific name	Annual yield (million <i>kan</i>)
<i>Naga-kombu</i>	<i>Laminaria angustata</i> var. <i>longissima</i> (MIYABE) MIYABE	270
<i>Mitsuishi-kombu</i>	<i>L. angustata</i> KJELLMAN	123
<i>Rishiri-kombu</i>	<i>L. ochotensis</i> MIYABE	110
<i>Atsuba-kombu</i>	<i>L. coriacea</i> MIYABE	53
<i>Ma-kombu</i>	<i>L. japonica</i> ARESCHOUG	51
<i>Hosome-kombu</i>	<i>L. religiosa</i> MIYABE	27
<i>Nekoashi-kombu</i>	<i>Arthrothamnus bifidus</i> (GMELIN) RUPRECHT	14
<i>Tororo-kombu</i>	<i>Kjellmaniella gyrata</i> (KJELLMAN) MIYABE	1
<i>Rausu-kombu</i>	Considered as the same species as <i>rishiri-kombu</i>	
<i>Gagome</i>	<i>K. crassifolia</i> MIYABE	
Others		203
Total		780

from 1946 to 1955 are summarized in Table 46. One million *kan*, units found in that table, is equivalent to 3,750 tons (metric).

Kombu is chiefly used in seasoning and in several kinds of foods such as *tsukudani*, and *tororo-kombu* which are processed from *kombu*. People in Kansai district of Japan especially relish *kombu* products. Most of the best quality *kombu* sent from Hokkaido is consumed in Kansai. Its quality is determined in detail at sea food markets. Shown in Table 47 are its prices, places of production, grades by inspection and manners of bundling (bundling style is occasionally important to distinguish *kombu* producing areas). Harvesting places are shown on the maps of Figures 4 and 5. The numbers on the two maps indicate the places as listed in Table 47.

Table 47. Items of the important species of *kombu* in 1957

Numbers representing the places of production	Species	Place of production	Grade by inspection	How bundled	Market price yen/ 10 <i>kan</i>
1	<i>Ma-kombu</i>	Yakumo	First	<i>Ori</i>	5,800
2	"	Yamakoshi	"	"	5,930
3	"	Otohibe	"	"	"
4	"	Mori	"	"	8,200
5	"	Sawara	"	<i>Motozoro-i</i>	12,700
6	"	Shikabe	"	"	13,000
7	"	Ōfuna	"	"	14,200
8	"	Usujiri	"	"	17,500
9	"	Yasuura	"	"	18,800
10	"	Kakkumi	"	"	20,500
11	"	Osatsube	"	"	20,000
12	"	Kennichi	"	"	"
13	"	Kinaoshi	"	"	16,700
14	"	Furube	"	"	15,300
15	"	Todohokke	"	"	13,700
16	"	Esan	"	"	"
17	"	Kobui	"	"	"
18	"	Shirikishinai	"	"	"
19	"	Hiura	"	"	"
20	"	Toi	"	"	13,300
21	"	Shiokubi	"	"	13,100
22	"	Kamaya	"	<i>Ori</i>	9,300
23	"	Oyasu	"	"	"
24	"	Ishizaki	"	"	9,200
25	"	Zenikamezawa	"	"	9,100
26	"	Uga	"	"	"
27	"	Nesaki	"	"	"

Table 47-2.

Numbers representing the places of production	Species	Place of production	Grade by inspection	How bundled	Market price yen/ 10 kan
28	<i>Ma-kombu</i>	Yunohama	"	<i>Ori</i>	9,000
29	"	Ōmori	"	"	8,900
30	"	Sumiyoshi	"	"	"
31	"	Kamiiso	"	"	4,500
32	"	Kikonai	"	"	5,400
33	"	Shiriuchi	"	"	"
34	<i>Rishiri-kombu</i>	Oshidomari	"	<i>Nagakiri</i>	13,500
35	"	Kutsugata	"	"	13,200
36	<i>Mitsuishi-kombu</i>	Hidaka	"	"	7,300
18	"	Shirikishinai	"	"	5,600
37	<i>Hosome-kombu</i>	Matsumae	"	"	6,800
38	<i>Naga-kombu</i>	Kushiro	"	"	3,530
	<i>Tororo-kombu</i>	"	Special	"	"
	<i>Nekoashi-kombu</i>	"	"	"	"
	<i>Atsuba-kombu</i>	"	First	"	4,000
39	<i>Gagome</i>	Kameda	"	<i>Motozoroi</i>	6,800
40	"	Kayabe	"	"	6,000
41	<i>Rausu-kombu</i>	Rausu	"	"	13,600
39	<i>Ma-kombu</i> (1st year plant)	Kameda	"	<i>Nagakiri</i>	1,500
40	"	Kayabe	"	"	"

Complicated *kombu* evaluation, especially for *ma-kombu* is done at the wholesale market by the *kombu* dealers. The evaluation is expressed in price. The method of evaluation is hard to understand by one without specialized training and experience. Besides the evaluation by dealers, each species of *kombu* from each place is graded from 1st to 3rd (or 4th sometimes) class by official inspection. The evaluation by dealers was studied first as related next in Part 3, (1), then geological and hydrographical studies were carried out on the life-environment of *ma-kombu*, Part 3, (2). In later parts (3 and 4), the quality as graded in Part 3, (1) was compared with the quantities of total nitrogen, amino nitrogen and amino acid composition of *kombu* extractives. Part 3, (5) is concerned with the influence of glutamic acid upon the preference of *kombu* extract.

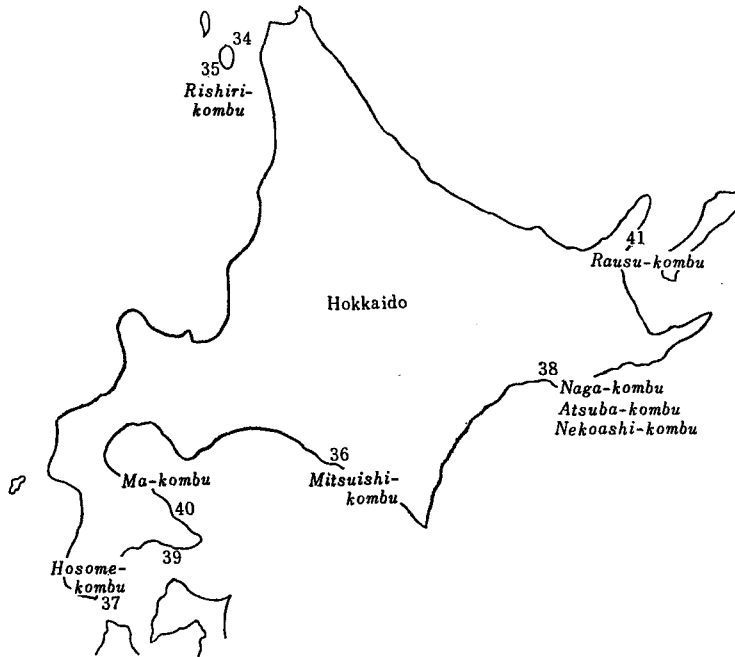

Fig. 4. Map of *kombu* harvesting place in Hokkaido (Numbers present the places listed in Table 47.)

1. Grading according to *kombu* quality

1.1. Quality estimation according to taste of water extractive

A stock extracted from two per cent of *kombu* by weight in boiling water for three minutes was most suitable for good soup, on the basis of the results of previous tests¹¹. Studies of the flavors of soup by a panel (several trained students) showed the following results. The size of the cut piece of *kombu* plant did not affect the flavor of the soup. An extract from a part near the stipe or base as shown in Figure 6, was better in flavor than the extractive of a part from near the top of the plant, the apex. The central part was better in flavor than the marginal sides when used as soup material. The inner part was somewhat better than the surface in flavor.

The grades by the official inspection did not reflect clearly the taste of the soup. The product harvested during pre-season seemed better than products harvested at other times. A one-year old (first year) plant, called *mizu-kombu*, was not as tasty as a two-year old (biennial) adult *kombu* plant of the same species. Plants harvested at seashore and offshore are evaluated differently in the market but a difference in taste between them was seldom found. No significant difference in taste according to locality of growth was observed by the test panel, even though different grades had been assigned in the market.

The following order of quality among the species of *kombu* was observed

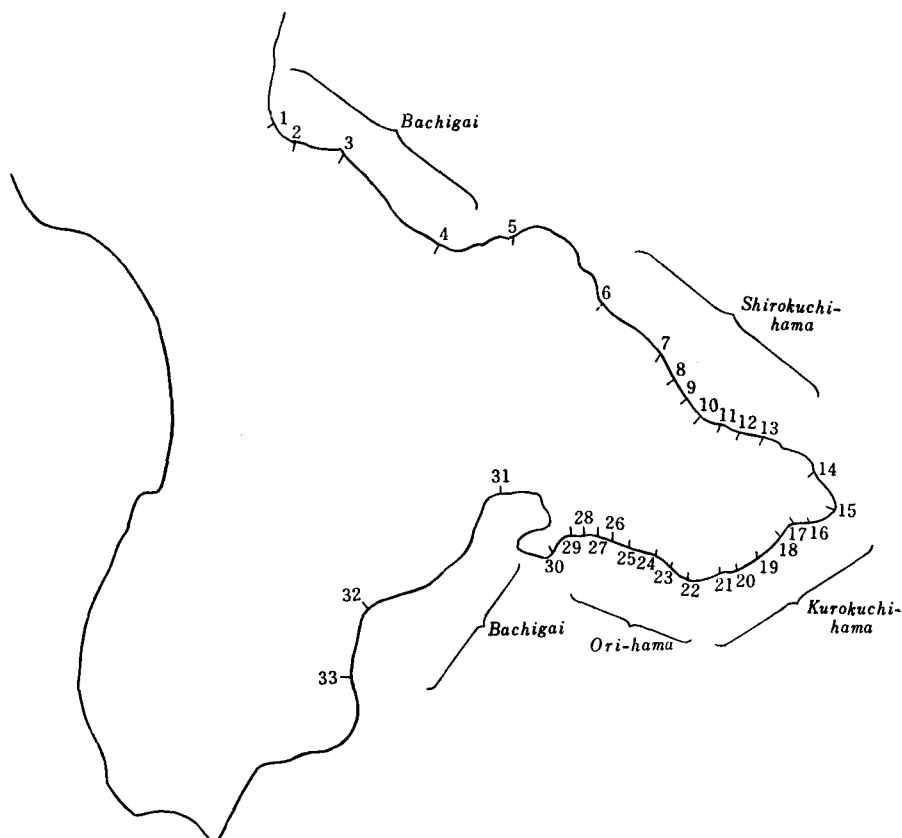

Fig. 5. Map of *ma-kombu* harvesting areas

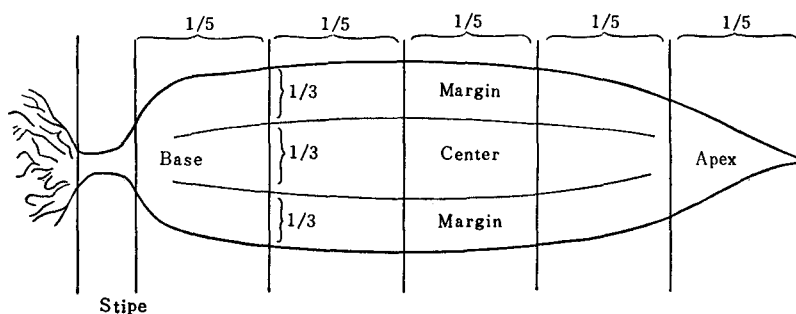

Fig. 6. Parts of *kombu* plant sampled

from the view point of seasoning. This order of superiority in taste among the species reflects clearly the market evaluations, but limited information on quality within a species was obtained.

Ma-kombu > *rishiri-kombu* > *mitsuishi-kombu* > *rausu-kombu* >
hosome-kombu > *gagome* > *naga-kombu* > *atsuba-kombu* >
nekoashi-kombu, *tororo-kombu*

1.2. Quality estimation according to viscosity

Viscosity is indispensable for *kombu* processing. So in this experiment viscosity was determined at 40°C with an Ostwald viscosimeter. After a study of extracting conditions had been made¹¹⁾, the sample liquids used here were prepared by boiling pieces of *kombu* plant (two per cent by weight) in water for ten minutes. The results of determination are shown in Table 48.

Table 48. Relative viscosity of some species of *kombu*

<i>Ma-kombu</i>	1.1 — 1.3
<i>Rishiri-kombu</i> (Kutsugata)	1.209
<i>Mitsuishi-kombu</i> (Hidaka)	1.022
<i>Rausu-kombu</i>	1.1
<i>Hosome-kombu</i>	1.189
<i>Gagome</i>	1.522
<i>Naga-kombu</i>	1.505
<i>Atsuba-kombu</i>	1.189
<i>Nekoashi-kombu</i>	1.146
<i>Tororo-kombu</i>	1.3 — 1.7

The viscosities of extractives from several parts of the plant body were approximately the same and showed no evidence of having been influenced by the harvesting season. Also viscosity had no relation with the grade assigned by the inspection. No difference was found either between a one-year old plant and a two-year one, nor between seashore and offshore plants. Though there was a difference due to the locality of growth, it was difficult to find any relation between the market quality and viscosity.

Regarding the different species, extractives from samples belonging to the *Kjellmaniella* were more viscous than those from *Laminaria* except *naga-kombu*. Generally speaking, the extractive from species ranked as high quality in the market was not as viscous as that from low quality species. However, *ma-kombu* was comparatively viscous although it was rated as high grade in the market. This may be a reason why *ma-kombu* is used for high quality processed foods.

The individual fluctuation of each six specimens of *ma-kombu* produced in Yakumo was expressed as possessing a coefficient of variance of 5.30, which is not excessively high.

1.3. Quality estimation according to shearing force

When used with other processed food or in cooking, it is necessary by means of boiling to render *kombu* tender and easily chewed; otherwise it is not considered good quality. Shearing force was determined by the use of an instrument newly made in the author's laboratory (see Figure 7).

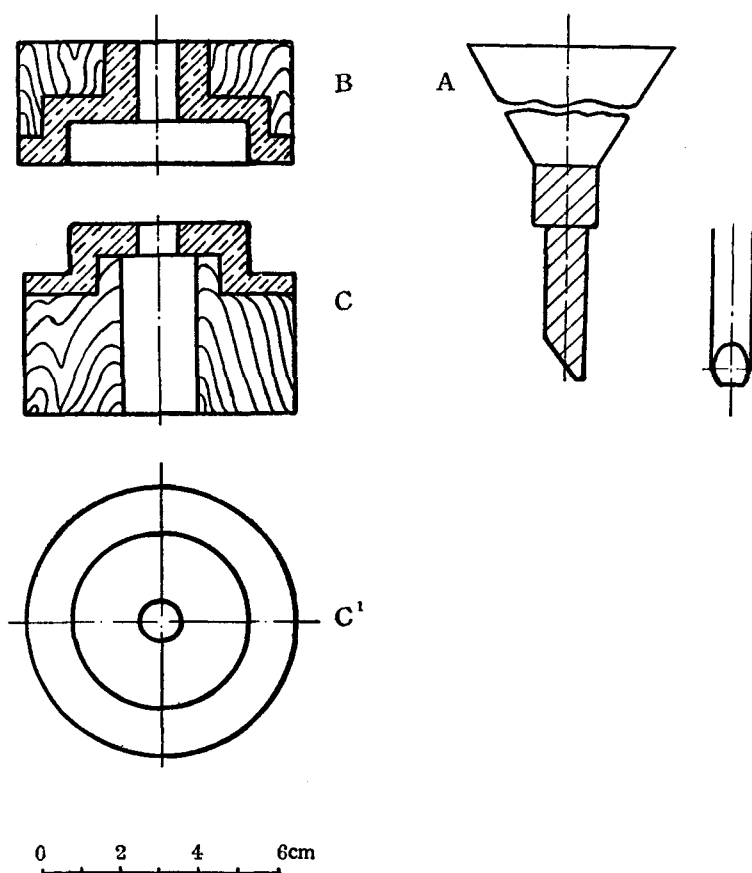

Fig. 7. Device for measuring shearing force

A piece of *kombu* plant becomes softer after boiling. The speed of softening was not affected by the use of saline or fresh water and was not affected by difference in species; the observations were on *naga-kombu*, *mitsuishi-kombu*, *chijimi-kombu* [*L. cichorioids* (MIYABE), product of Rausu] and *ma-kombu*. Two to four hours of boiling at 100°C were enough to soften the *kombu*. Heating in water for less than 24 hours at 60°C, or 49 hours at 30°C, did not soften the material. The individual fluctuation in the case of 2 hour heating at 100°C was studied using each six specimens of *mitsuishi-kombu*. The coefficient of variance was found to be 22.04.

The degree of shearing force per unit thickness differed according to the various parts of the plant body; the force required to shear the central part was the largest while that for the middle margin was the smallest.

The relation between species and shearing force is shown in Table 49. An obscure relation between the quality as it is evaluated in the market and the shearing force was found to exist.

Table 49. Shearing force of various species of *kombu*

Species of sample	Weight required for shearing (g)	Thickness of boiled <i>kombu</i> (mm)	g/mm
<i>Ma-kombu</i>			
(Osatsube)	263.7	2.29	115.1
(Yakumo)	280.2	1.59	175.7
(Mori)	507.7	2.07	245.5
(Shirikishinai), 1st year plant	274.7	1.38	199.0
<i>Rishiri-kombu</i>			
(Kutsugata)	529.2	2.00	264.6
(Kutsugata), 1st year plant	280.7	1.63	172.2
(Oshidomari)	265.7	2.27	117.0
(Senposhi)	435.7	1.84	236.7
<i>Mitsuishi-kombu</i>			
(Hidaka)	288.7	1.69	170.8
<i>Hosome-kombu</i>			
(Matsumae)	278.7	1.22	228.4
<i>Rausu-kombu</i>			
seashore	159.3	2.25	70.8
offing	136.7	2.27	50.2
<i>Naga-kombu</i>			
(Nemuro)	191.7	1.06	180.0
<i>Atsuba-kombu</i>			
(Habomai)	189.7	1.62	117.0
(Akkeshi)	246.7	1.96	125.8
<i>Chijimi-kombu</i>			
(Rausu)	216.7	2.01	107.8
<i>Nekoashi-kombu</i>			
(Habomai)	346.7	1.54	225.1
<i>Gagome</i>			
(Toi)	504.7	1.53	329.8

Regarding the different species, *mitsuishi-kombu* which is evaluated as suitable for cooking by boiling, was found not to be so tender after boiling as was previously expected. Some samples of *ma-kombu* (growing in different places), *rishiri-kombu* and *rausu-kombu*, were very soft. They are good in quality for some processed *kombu*. Accordingly they are highly evaluated in the market, because they have both good taste and soft texture. Even though their qualities were not so good, the textures of *atsuba-kombu* and *chijimi-kombu* were soft, in spite of their thickness.

1.4. Quality estimation according to color of boiled "kombu"

In the market, the color of boiled *kombu* is considered as one of the important characters influencing its quality, e.g., *mitsuishi-kombu* is highly estimated by consumers for its slightly greenish color after boiling.

The color of boiled *kombu* was determined and recorded by comparison with

the standard color table prepared by the *Nihon-shikisai-kenkyujo*⁴⁴⁾. The results are shown in Table 50.

With respect to hue most values of boiled samples were in the range of 6 to 7, while a few attained nearly 8. Their hues were distinguished as yellow-orange and reddish-orange. Most of them were situated within the narrow range of yellowish brown to dark yellowish brown. It can scarcely be said that the color of boiled *kombu* is an important feature in determining its quality rating.

Table 50. Color of boiled *kombu* samples

Species	Place of production and other items	Hue	Lumi- nosity	Satura- tion
<i>Ma-kombu</i>	Osatsube	7	15	4
	Shirikishinai, pre-season, 1st grade	6	13	3
	Shirikishinai, season, 1st grade	7	13	3
	Shirikishinai, season, 2nd grade	7	13	3
	Shirikishinai, season, 3rd grade	7	15	4
	Shirikishinai, off-season, 1st grade	6	13	3
	Sumiyoshi	6	15	4
	Mori	6	13	3
	Yakumo	7	13	3
<i>Rishiri-kombu</i>	Oshidomari, 1st grade	7	13	3
	Senposhi, 1st grade	6	13	3
	Kutsugata, 1st grade	6	13	3
	Kutsugata, 1st year plant	7	13	3
<i>Mitsuishi-kombu</i>	Hidaka, 1st grade	7	13	3
	Shirikishinai	7	13	3
<i>Hosome-kombu</i>	Matsumae	3	13	3.5
<i>Rausu-kombu</i>	Rausu, offing	6.5	13	3
	" seashore	6.5	13	3
<i>Naga-kombu</i>	Akkeshi	7	15	4
	Nemuro	7.5	15	4
<i>Atsuba-kombu</i>	Habomai	7	13	3
	Akkeshi	7	13	3.5
<i>Tororo-kombu</i>	Akkeshi	7	13	3
<i>Nekoashi-kombu</i>	Habomai	7	13.5	2.5

1.5. Relation between quality and thickness of the plant blade

Thickness is an important character in governing judgment as to the quality of *kombu*. The thickness at equivalent parts of the plants was determined with a micrometer, use being made of more than ten sample plants for each species. The determined values were then averaged. The results are shown in Table 51. The samples having over 1 mm thickness of dried material were *ma-kombu*, *rishiri-kombu* and *rausu-kombu*. All of them are important species used for processed *kombu*.

Table 51. Thickness of *kombu* samples

Kind of Sample		Thickness (mm)
<i>Ma-kombu</i> ,	Mori	1.1
"	Sumiyoshi	1.1
"	Osatsube	1.1
"	Yakumo	0.8
"	Shirikishinai, pre-season, 1st grade	1.3
"	" " 2nd grade	0.83
"	" " 3rd grade	0.65
"	" season, 1st grade	1.13
"	" " 2nd grade	1.0
"	" " 3rd grade	1.15
"	" off-season, 1st grade	1.3
"	" " 2nd grade	1.23
"	" " 3rd grade	1.05
"	" 1st year plant	0.67
<i>Gagome</i> ,	Toi	0.70
<i>Mitsuishi-kombu</i> ,	Hidaka	0.50
"	Shirikishinai	0.90
<i>Rishiri-kombu</i> ,	Kutsugata, 1st grade	1.25
"	" 2nd grade	0.93
"	" 3rd grade	0.85
"	" 4th grade	0.50
"	" 1st year plant	0.64
"	Oshidomari, 1st grade	0.91
"	" 2nd grade	0.90
"	" 3rd grade	0.87
"	" 4th grade	0.87
"	Senposhi	0.65
<i>Hosome-kombu</i> ,	Matsumae	1.05
<i>Chijimi-kombu</i> ,	Rausu	0.87
<i>Rausu-kombu</i> ,	Rausu, offing	1.04
"	" seashore	1.05
<i>Naga-kombu</i> ,	Nemuro	0.33
"	Akkeshi	0.78
<i>Atsuba-kombu</i> ,	Akkeshi	0.77
"	Habomai	0.46
<i>Nekoashi-kombu</i> ,	Habomai	0.45
<i>Tororo-kombu</i> ,	Akkeshi	0.30
"	Habomai	0.20

1.6. Conclusions

Each species of *kombu* was graded under the following conditions. If a kind of *kombu* was of ideal quality, ten points in all were given to it, considering weight (importance) of each item.

1) Grades from zero to seven were given to the sample seaweeds according to the degree of strength of their seasoning power.

2) From zero to one point was given in accordance with the shearing force of the boiled sample.

3) The same range of points as in section 2) was used to represent the viscosity of the water extract of the sample.

4) The same scores as in 2) were given to the thickness of dried sample seaweed.

5) A grade of zero for color was given to all samples, since no distinct differences were found.

The scores for each species of seaweed were totaled. The order of this scoring was regarded as representing the rank of quality among the species as shown in Table 52.

Table 52. Scoring on the quality of *kombu*

Species	Taste	Viscosity	Shearing force	Thickness	Total
<i>Ma-kombu</i>	7	0	0	1	8
<i>Rishiri-kombu</i>	6	0	0	1	7
<i>Mitsuishi-kombu</i>	5	0	0	0	5
<i>Rausu-kombu</i>	4	0	1	1	6
<i>Hosome-kombu</i>	3	0	0	1	4
<i>Gagome</i>	2	1	0	0	3
<i>Naga-kombu</i>	1	1	0	0	2
<i>Atsuba-kombu</i>	1	0	1	0	2
<i>Nekoashi-kombu</i>	0	0	0	0	0
<i>Tororo-kombu</i>	0	1	0	0	1
<i>Ma-kombu</i> (1st year plant)	0	0	0	0	0

2. Factors determining the quality of *Laminaria japonica*

Ma-kombu (*Laminaria japonica*) is judged popularly to be the highest in quality. The quality changes according to the locality from which plants come. Plants from Kakkumi are considered of supreme quality and the farther from Kakkumi (locality No. 10 on map in Figure 5) on both sides, the lower the quality becomes. The changing of the market grading is very marked, e.g., the price for 37.5 kg of dried seaweed decreases about one thousand *yen* per every kilometer of coastal line from Kakkumi; Compare the price as shown in Table 47 and the distances on the map in Figure 5. There are many assumptions to explain such a strange distinct grading change according to locality.

To ascertain the relation, if any, between the quality and the life-environment, geological and hydrographical investigations were carried out along the coast line eastward from Hakodate as shown in the map of Figure 8.

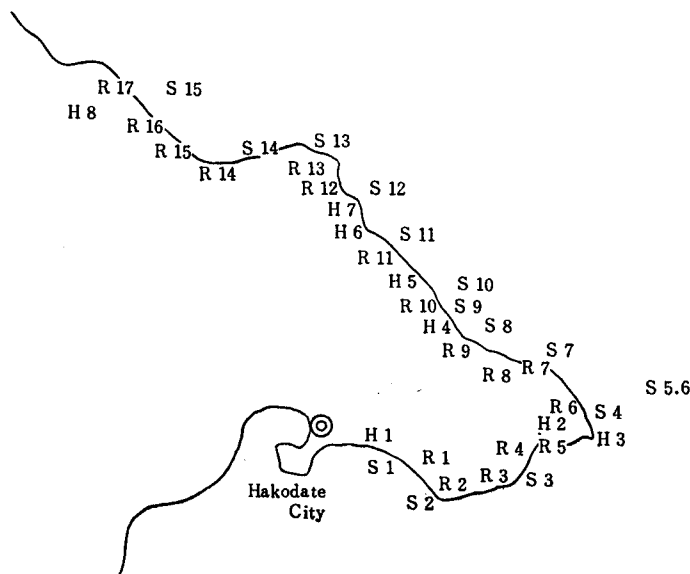
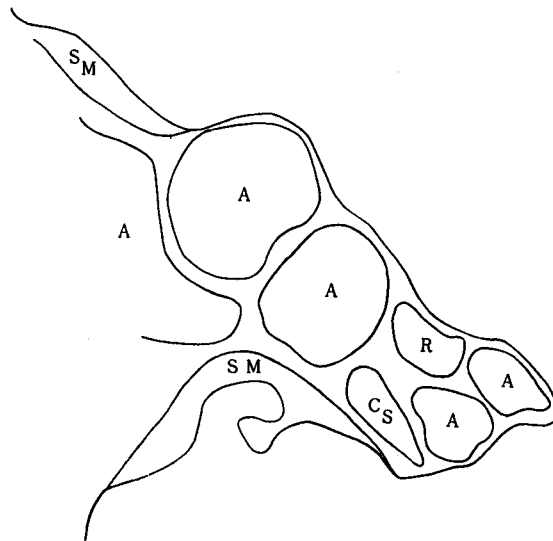

Fig. 8. Map of water sampling places (The places shown by marks "S 2", "H 8", "R 3" and so on, correspond to the sea, river and hot spring places in Tables 54, 55 and 56, respectively.)

Geologically, from the author's examination on the sort of rock and topographical patterns, the following item, perhaps significant, was noted: Habitat of high quality *L. japonica* is a pebbly beach of rhyolite, which is rather white in color and rich in silicate, while *kombu* plants of middle class quality distribute on beaches of andesite, and the poorest plants are on beaches of sand- or mudstone. Average chemical compositions of each of some types of rhyolite and several kinds of andesite in Hokkaido which were computed by Dr. K. Oshide, professor of Hokkaido Gakugei University, for the author, are shown in Table 53. A geological map⁴⁵⁾ is sketched in Figure 9 to elucidate the above mentioned facts. But these geological facts may be merely fortuitous, because this matter of habit cannot be said to be a *sine que non* for the best quality.

Table 53. Average chemical compositions respectively of rhyolite and andesite samples from Hokkaido calculated by Dr. K. Oshide

	SiO ₂	Al ₂ O ₃	Fe ₂ O ₃	FeO	MgO	CaO	Na ₂ O	K ₂ O	H ₂ O	TiO	P ₂ O ₅	MnO
Rhyolite	73.03	12.97	0.65	0.79	0.53	0.98	3.79	3.38	0.49	0.05	tr.	0.13
Andesite	57.13	14.40	6.03	5.45	3.17	6.81	3.04	1.41	1.76	0.80	0.18	0.14

Fig. 9. Geological map of *ma-kombu* growing areas

A....Andesite CS....Clay slate
R....Rhyolite SM....Sandstone or mudstone

Hydrographically, the waters of the sea, rivers and hot springs as shown in Figure 8 were sampled; the temperature, pH value of water, consumption of

Table 54. Hydrographical data on sea water (August, 1958)

No. of place	Sampling place	Sampling hour	Atmospheric temp. °C	Temp. of sea water °C	pH	KMnO ₄ mg/l	Cl %	N mg/l	P mg/l
S-1	Yunokawa	Aug. 3 a.m. 10	21	21	7.72	3.99	18.24	0.63	.01
S-2	Oyasu	Aug. 3 a.m. 9	26.5	22	7.81	4.67	18.75	0.68	<.01
S-3	Shirikishinai	Aug. 3 p.m. 4	21	19	7.62	4.40	18.14	0.84	.01
S-4	Todohokke	Aug. 4 a.m. 8	19	18.5	7.70	3.66	16.47	0.77	.01
S-5	" offshore surface	Aug. 4 a.m. 10	19	18	7.69	3.59	17.42	0.91	.01
S-6	" offshore bottom	Aug. 4 a.m. 10	19	18	8.01	3.53	17.90	0.91	.01
S-7	Kinaoshi	Aug. 4 a.m. 12	19	18	7.30	3.53	< 15	0.48	<.01
S-8	Osatsube	Aug. 4 a.m. 12	20	19.5	7.34	3.81	< 15	0.66	.01
S-9	Kakkumi	Aug. 4 p.m. 3	21	20	8.00	3.81	16.36	0.58	.02
S-10	Ōfuna	Aug. 5 a.m. 10	22	18	7.70	3.43	< 15	0.53	<.01
S-11	Isoya	Aug. 5 a.m. 11	23	18.5	7.79	4.77	17.49	0.59	.01
S-12	Shikabe	Aug. 5 a.m. 10	26	21	7.52	4.12	< 15	0.77	.02
S-13	Numajiri	Aug. 5 p.m. 3	23	21	7.51	4.49	15.73	0.84	.04
S-14	Oshiranai	Aug. 5 p.m. 3	26	19	7.62	4.58	17.66	0.53	<.01
S-15	Ishikura	Aug. 6 a.m. 11	25.5	21.5	7.70	1.45	< 15	0.91	.01

potassium permanganate, chlorinity, and contents of total nitrogen and of total phosphate were measured. The results of analyses are exhibited in Tables 54, 55 and 56.

Table 55. Hydrographical data on river water (August, 1958)

No. of place	Sampling place	Sampling hour	Atmospheric temp. °C	Temp. of r. water °C	pH	KMnO ₄ mg/l	Cl %	N mg/l	P mg/l
R-1	Shiodomari River	3 a.m. 10	23	16.5	7.0	0.71	<15	0.48	<.01
R-2	Takayashiki R.	3 a.m. 10	23	18	6.4	0.68	"	0.41	"
R-3	Kumabetsu R.	3 p.m. 1	22.5	16	6.4	0.46	"	0.59	"
R-4	Shirikishinai R.	3 p.m. 4	21	15	7.0	1.26	"	0.46	"
R-5	Kobui R.	3 p.m. 5	21	17	4.4	0.40	"	0.46	"
R-6	Yajiri R.	4 a.m. 8	19	15	6.4	0.48	"	0.44	"
R-7	Shirai R.	4 a.m. 12	19	15	4.0	0.61	"	0.46	"
R-8	Yagi R.	4 a.m. 12	21	15	5.12	0.10	"	0.44	"
R-9	Kakkumi R.	4 p.m. 3	21	17	6.8	0.50	"	0.44	"
R-10	Ōfunu R.	5 a.m. 9	22	17	6.95	0.30	"	0.66	"
R-11	Isoya R.	5 a.m. 10	23	19	7.2	1.45	"	0.46	"
R-12	Orido R.	5 a.m. 10	26	17.5	3.5	0.77	"	0.59	"
R-13	Myojin R.	5 p.m. 2	22	14.5	6.82	1.45	"	0.66	"
R-14	Oshiranai R.	5 p.m. 4	24	20	6.88	1.12	"	0.74	"
R-15	Torizaki R.	6 a.m. 11	27	21.5	7.4	1.24	"	0.41	"
R-16	Ebiya R.	6 a.m. 11	24.5	15.5	7.18	0.94	"	0.77	"
R-17	Nigori R.	6 a.m. 11	25.5	22	7.70	2.19	"	0.56	"

Table 56. Hydrographical data on hot spring water (August, 1958)

No. of place	Sampling place	Sampling hour	Atmospheric temp. °C	Temp. of h.s. water °C	pH	KMnO ₄ mg/l	Cl %	N mg/l	P mg/l
H-1	Yunokawa	3 a.m. 10	21	52	7.32	10.54	<15	0.74	1.02
H-2	Esan	3 p.m. 8	21	43	2.10	0.52	"	0.56	<.01
H-3	Isoya (Kameda)	3 p.m. 3	22	41	7.60	0.24	"	0.77	"
H-4	Kakkumi	4 p.m. 4	21	43	8.85	0.09	"	0.43	"
H-5	Ōfunashimo	5 a.m. 10	22	51	7.92	0.30	"	0.91	"
H-6	Isoya (Kayabe)	5 a.m. 11	23	54	7.60	0.56	"	0.91	"
H-7	Shikabe	5 a.m. 10	26	54	7.19	0.09	"	0.91	"
H-8.1	Nigorikawa (right)	6 a.m. 6	19.5	54.5	7.02	0.33	"	0.91	"
H-8.2	Nigorikawa (left)	6 a.m. 6	19.5	48.5	7.35	0.77	"	0.77	"
H-8.3	Nigorikawa (inner)	6 a.m. 6	19.5	41.5	7.00	0.25	"	0.56	.01

In conclusion, it must be said that so far as the present analyses were concerned, no relationship was found between hydrographical factors and the

market evaluation of *L. japonica* itself. Geologically, one relation to the evaluation was suggested.

3. Relation between quality of *kombu* and quantity of extractive nitrogen

This characteristic of extractive nitrogen is one of the important factors which seem to influence the quality of *kombu*. To test the point the following experiment was carried out.

Each definite amount of the part "base" (shown in Figure 6) of all kinds of *kombu* samples except *shirokuchi-hama-ma-kombu* was extracted with seventy per cent ethyl alcohol seven times for seven days until the ninhydrin reaction almost disappeared. All seven extractives were mixed into one volume of about one and a half liters and then the mixture was concentrated under vacuum to remove the alcohol. The amount of alcohol used in each extraction was enough in quantity to dip or to cover the sample. The residue from which alcohol was removed was dissolved in a small amount of water and made up to a definite volume.

Shirokuchi-hama-ma-kombu was extracted with fifty times its weight of boiling water for three minutes using the same method as in the making of *ichiban-dashi* for soup. This word *ichiban-dashi* is a term in cooking and the re-extractive of the residue of *ichiban-dashi* is called *niban-dashi* quite the same as in the case of *katsuwo-bushi* noted previously. Then the *ichiban-dashi* was concentrated under vacuum and to it was added absolute alcohol to make a seventy per cent alcohol solution. After removal of alcohol from the filtrate, an aqueous solution of the extractive was made by the same method as in making the other sample liquids. The residue of *ichiban-dashi* was extracted with seventy per cent alcohol seven times; by this method the other species of *kombu* were also extracted. Each one-half of both extractives, *ichiban-dashi* and *niban-dashi*, was hydrolyzed by means of 3 N HCl, at 120°C (15 lbs.) for 7 hours.

To determine any difference according to the part of the plant, four positions were separately extracted as shown in Figure 6: the "apex" is the top one-fifth of the total length of the plant, the "center" is the third one-fifth of the total length excluding margins that is the middle one-third of the plant width, the "marginal part" is one-third on both sides of the plant width and lastly the "stipe".

Thus twenty-four kinds extractive samples were prepared. They were analysed for total nitrogen, amino nitrogen and amino acid composition. In the following Table 57 the names of extractive samples and the amounts of total nitrogen, α -amino nitrogen and ratio of amino nitrogen to total nitrogen are shown.

The quantity of total nitrogen, amino nitrogen, the ratio of amino nitrogen to total nitrogen, market price and the quality order as evaluated in Part 3, (1) above, were compared with each other after calculation of the coefficient of correlation "r" by the following equation:

$$r = \frac{\sum(x_i - \bar{x})(y_i - \bar{y})}{\sqrt{\sum(x_i - \bar{x})^2 \sum(y_i - \bar{y})^2}}$$

Table 57. Total and α -amino-N and their ratio (AN/TN)

Extractive sample	Total-N mg per 100 g of dried <i>kombu</i>	α -amino-N mg per 100 g of dried <i>kombu</i>	AN/TN (%)
<i>Ma-kombu</i> (Osatsube)			
<i>Ichiban-dashi</i> (ID)	220	180	82
Hydrolyzed-ID		220	100
<i>Niban-dashi</i> (ND)	590	260	44
Hydrolyzed-ND		300	51
<i>Ma-kombu</i> (Shirikishinai)			
Pre-season	390	330	85
Season, 1st grade	630	610	97
2nd grade	750	680	91
3rd grade	690	580	84
Off-season	330	300	91
<i>Ma-kombu</i> (Shirikishinai)			
Apex	240	130	54
Margin	280	100	36
Stipe	340	230	68
Center	440	290	66
<i>Ma-kombu</i> (Shirikishinai)			
1st year plant	360	160	44
<i>Ma-kombu</i> (Sumiyoshi)	450	360	80
<i>Ma-kombu</i> (Yakumo)	170	90	29
<i>Rausu-kombu</i>			
Seashore	660	500	76
Offshore	730	550	75
<i>Rishiri-kombu</i>	320	310	97
<i>Mitsuishi-kombu</i>	310	210	68
<i>Hosome-kombu</i>	650	550	85
<i>Gagome</i>	320	270	84
<i>Naga-kombu</i>	260	140	54
<i>Tororo-kombu</i>	290	110	38

The results are shown in Table 58. From these data the following conclusions were drawn.

1) No significant difference at the 1% level was found between total nitrogen and amino nitrogen, and between quality order and market price.

2) No significant differences at the 5% level were found between the price and total nitrogen, price and amino nitrogen, quality and total nitrogen, and quality and amino nitrogen.

3) No definite relationship was found between the price and the ratio of amino nitrogen to total nitrogen.

4) Table 57 reveals the following facts: The amounts of amino and total nitrogens related neither to the grade given by official inspection nor to the market evaluation by harvesting season. Regarding the nitrogen contents of

Table 58. Correlation coefficient (r), among total nitrogen (TN), amino-nitrogen (AN), market price and quality

		r
TN AN	0.915
Market price quality	0.963
Market price TN	0.688
Market price AN	0.685
Market price AN/TN	0.248
Quality TN	0.597
Quality AN	0.661
Quality AN/TN	0.548

seashore and offshore plants, a reverse relationship was found to the market evaluation. As to those of a one-year or a two-year plant, of the part of plant lamina, and of *ma-kombu* harvested from different areas, definite relationships were found with their market evaluations, viz., the poorer products contained less amounts of the nitrogens.

5) The relation between the non-hydrolyzed extractives of *ichiban-dashi* and *niban-dashi*, is also shown in Table 57. About 80% of the total nitrogen of *ichiban-dashi* was composed of free amino compounds whilst the residue or the remaining 20% of the nitrogen was completely hydrolyzed into amino compounds. The amino nitrogen of the *niban-dashi* was 44% of the total nitrogen; the non-amino nitrogen compounds were hydrolyzed to amino acid which was only 7% of the total nitrogen. This means that 50% of non-amino nitrogen was contained in *niban-dashi* extractive.

4. Relation between quality of *kombu* and amino acid composition of the extractive

The amount of amino acids contained is one of the most important factors influencing the quality of *kombu*, because monosodium glutamate (M.S.G.) widely used as a seasoning is one of the amino acids. Since there is no available proof of the relationship between the concentrate of M.S.G. and the quality of food, a study of this point would seem to be important also from the standpoint of general food chemistry.

The samples used in this part were the ones which had been used in the preceding Part 3, (3). After removing salts from the sample extractives, sixteen amino acids were determined by microbioassay. The results of analyses are shown in Table 59.

The removal of salts from the *kombu* extractives was an important step in determining the amino acids by microbioassay, for the samples contained such a great quantity of salts that the growth of the test microorganisms was disturbed. The following procedure was applied in order to remove the salts: The sample, stored in a refrigerator and covered with toluene to prevent microbial action, was extracted with ether. The toluene and fat contained in that extractive

Table 59. Amino acid composition of *kombu*

Extractive sample	Alanine	Aspartic acid	Glutamic acid	Glycine	Histidine	Iso-leucine
<i>Ma-kombu</i> (Osatsube)						
<i>Ichiban-dashi</i>	39.71	597.7	712.2	2.76	0.492	2.36
<i>Niban-dashi</i>	57.24	986.3	1471	4.84	0.241	3.86
<i>Ma-kombu</i> (Shirikishinai)						
Pre-season	95.17	1159	2331	6.31	0.485	3.17
Season, 1st grade	149.5	1450	4100	9.16	0.786	7.45
2nd grade	141.3	1383	1708	7.70	0.876	11.67
3rd grade	188.0	1775	4226	10.87	1.550	12.98
Off-season	155.0	900.4	1497	5.00	0.429	2.25
<i>Ma-kombu</i> (Shirikishinai)						
Apex	89.34	228.1	747.2	4.10	0.458	1.93
Margin	67.67	291.4	746.9	4.19	0.562	2.04
Stipe	153.6	878.0	1499	6.51	0.866	3.57
Center	127.8	888.0	2205	6.67	0.765	7.89
<i>Ma-kombu</i> (Shirikishinai)						
1st year plant	226.0	353.5	1177	9.98	0.944	4.64
<i>Ma-kombu</i>						
(Sumiyoshi)	66.29	1023	2352	6.95	0.379	5.08
(Yakumo)	49.84	179.5	374.7	2.95	0.152	2.29
<i>Rausu-kombu</i> (Rausu)						
Seashore	119.9	1746	3496	9.93	0.368	4.93
Offshore	127.2	1802	3957	8.39	0.477	5.62
<i>Rishiri-kombu</i>	58.36	1188	1284	5.49	0.278	3.14
<i>Mitsuiishi-kombu</i>	145.4	765.2	1106	11.26	0.095	3.56
<i>Hosome-kombu</i>	86.92	2099	2456	9.27	0.537	3.99
<i>Gagome</i>	109.4	969.9	1114	9.55	0.278	3.74
<i>Naga-kombu</i>	151.5	113.8	426.2	7.15	0.218	3.45
<i>Tororo-kombu</i>	195.8	34.63	59.18	4.42	0.149	2.12

moved to the ether layer. Two hundred cc of extractive was passed through a glass column which was filled with 150 cc of ion exchange resin, Dowex 50×4, 20—50 mesh in size and in H-form. The ether was washed with water and this washing was added to the original sample. Then a N/5 NH₄OH solution was passed through this column. Thus non-salt samples of amino acids were prepared quantitatively except arginine which remained in the column resin as it is strongly alkaline. The de-salted sample liquids were covered with toluene and stored in a refrigerator.

The following observations are based upon the data in Table 59.

1) *Difference between "ichiban-dashi" and "niban-dashi" of "kombu"*

Generally, the quantities of many kinds of amino acids were larger in *niban-dashi* than in *ichiban-dashi* contrary to the case of *katsuwo-bushi* itself. The ratios of amino acids of *ichiban-dashi* to *niban-dashi* are seen in column (1)

extractives (mg per 100 g dried matter)

Leucine	Lysine	Methionine	Phenylalanine	Proline	Serine	Threonine	Tryptophan	Tyrosine	Valine
1.65	1.98	0.95	3.42	107.7	10.79	8.84	0.174	1.48	3.84
3.15	3.66	1.57	7.99	126.6	16.20	11.34	0.132	3.36	5.92
4.31	2.38	1.74	4.16	100.7	21.41	9.34	0.356	5.71	2.41
5.04	5.04	3.12	4.56	174.6	27.37	16.69	0.382	4.07	3.09
6.57	4.68	2.20	7.26	192.7	35.29	19.64	0.265	5.01	7.22
9.87	10.49	3.45	8.72	279.1	37.38	35.30	0.499	4.90	3.82
2.50	2.63	1.33	2.55	118.9	16.91	12.06	0.386	7.35	2.80
1.25	2.09	0.41	1.23	35.2	8.29	3.46	0.105	3.24	1.51
1.78	0.48	0.49	1.44	39.5	10.81	5.33	0.116	4.01	5.30
3.53	2.60	1.47	3.29	196.9	14.10	9.78	0.337	4.61	3.46
5.78	3.59	2.11	5.14	90.4	15.75	8.39	0.443	5.42	10.24
3.21	3.76	1.89	4.17	410.8	13.12	8.55	0.168	2.23	9.27
4.29	3.49	2.03	4.78	76.78	14.45	8.37	0.274	5.07	10.36
2.29	0.94	0.58	2.61	39.22	6.51	3.43	0.161	2.95	3.67
2.39	3.23	3.73	3.39	243.5	17.58	24.45	0.233	2.36	8.98
4.07	3.09	4.21	9.23	250.7	18.77	27.05	0.264	2.60	12.83
2.34	3.86	1.46	4.91	81.82	14.42	7.94	0.211	4.43	5.43
3.56	1.07	2.13	3.32	156.8	23.96	13.67	0.054	3.17	8.47
3.11	3.22	2.32	2.59	39.79	13.62	13.45	0.288	2.20	5.85
2.52	1.29	2.00	2.70	51.29	18.68	16.00	0.117	1.16	6.62
3.30	2.14	1.69	2.57	194.4	26.22	12.68	0.068	3.43	8.33
1.80	0.82	1.52	1.92	166.7	15.64	11.60	0.033	2.05	4.10

of Table 60. Most of the ratios are less than 1.0. Quantities of glutamic acid, phenylalanine and tyrosine of *niban-dashi*, each amounted to two times as much as the quantities in *ichiban-dashi*; histidine and tryptophan of *niban-dashi* were low in quantity when compared with the content in *ichiban-dashi*. The phenomena are explained by the actualities of amino acid solubility in water, that is to say, glutamic acid, aspartic acid, phenylalanine and tyrosine, which were less in quality in *ichiban-dashi*, are dissolved in water with difficulty.

2) Relation between harvesting season and amino acid composition

The values 1, 2 and 3 were given respectively to the pre-season, mid-season and late season of harvesting, because in many cases, the pre-season product is believed by consumers to be better than the other two in quality. The values were calculated for each of the amino acid quantities by Spearman's rank correlation method. The results were expressed as the coefficient of correlation "rs" and are

Table 60. Comparative results on determined amino acid quantities

- (1) Ratio of amino acid contained in *ichiban-dashi* to that in *niban-dashi*
- (2) Coefficient of rank correlation "rs" between harvesting season and quantity of amino acid
- (3) Value of "rs" between market grade and quantity of amino acid
- (4) Value of "rs" between body of plant and quantity of amino acid
- (5) Value of "rs" between harvesting place and quantity of amino acid
- (6) Ratio of amino acid contents of seashore plant to offshore plant
- (7) Ratio of amino acid contained in second year plant to that in first year plant
- (8) Value of "rs" between species and quantity of amino acid

	(1)	(2)	(3)	(4)	(5)	(6)	(7)	(8)
Alanine	0.7	-1.0	-0.5	0.6	0.8	0.9	0.7	-0.407
Aspartic acid	0.6	0.5	-0.5	1.0*	1.0	1.0	4.1	0.776
Glutamic acid	0.5	0.5	-0.5	0.9	0.4	1.0	3.5	0.727**
Glycine	0.6	0.5	-0.5	1.0*	0.8	1.2	0.9	0.083
Histidine	2.0	0.5	-1.0	0.7	0.8	0.8	0.8	0.335
Isoleucine	0.6	0.5	-1.0	0.9	0.8	0.9	1.6	0.636
Leucine	0.5	0.5	-1.0	0.9	0.8	0.6	1.6	0.545
Lysine	0.4	-0.5	-0.5	0.9	1.0	1.1	1.3	0.650*
Methionine	0.6	0.5	-0.5	0.9	0.8	0.9	1.7	0.664*
Phenylalanine	0.4	0.5	-1.0	0.9	0.8	0.4	1.1	0.713**
Proline	0.9	-0.5	-1.0	0.7	1.0	1.0	0.4	0.097
Serine	0.7	0.5	-1.0	1.0*	0.8	0.6	2.1	0.503
Threonine	0.8	-0.5	-1.0	0.9	1.0	0.9	2.0	0.531
Tryptophan	1.3	-1.0	-0.5	0.9	0.8	0.9	2.3	0.720**
Tyrosine	0.4	-0.5	-0.5	0.7	0.4	0.9	1.8	0.615
Valine	0.7	-0.5	-0.5	0.6	0.0	0.7	0.3	0.041

* Significant at the 5% level

** Significant at the 1% level

shown in column (2) of Table 60, though the significance cannot be estimated as a generalization because the number of samples was less than 5. Alanine and tryptophan were completely reversed in correlation, but clear-cut relations were not found in the case of the other amino acids.

3) *Relationship between the grade by official inspection and amino acid composition*

Samples were compared with the grades of 1st, 2nd and 3rd by the same method as described in section 2) above. All of the coefficients of correlation "rs" were found to be negative. Histidine, isoleucine, leucine, phenylalanine, proline, serine and threonine showed complete reversal in the relation; the values of "rs" were -1.0.

4) *Relationship between the position on "kombu" lamina from which samples are taken and amino acid composition*

In the same way as the difference in taste was studied in Part 3, (1.1), the

values 1, 2, 3, 4 and 5 were given to the base, center, stipe, margin and apex of the plant respectively. All the values "rs" in column (4) of Table 60 are plus; they are especially high for aspartic acid, glycine and serine. From the quantities of amino acids, the following fact was observed: The parts of base, center and stipe were rich in contents of amino acids while the margin and apex were poor in those of these compounds. Generally speaking, amino acids are concentrated in *kombu* lamina nearer to the root and center than to the apex and margin.

5) *Relation between locality of origin of "kombu" plant and amino acid composition*

To *ma-kombu* samples from four different areas, viz., Shirokuchihama, Kurokuchihama, Orihama and Bachigai, values of 1, 2, 3 and 4 were given respectively according to the market evaluation. The "rs" values obtained by Spearman's procedure as shown in column (5) of Table 60 show positive correlations. In this case, it seems that the amino acid concentration may affect the quality. But in the panel's judgment, it was difficult to give rankings.

6) *Relation between habitat, offshore or seashore, and amino acid composition*

The ratios of amino acid content between seashore and offshore products are exhibited in column (6) of Table 60. The quantity of each amino acid from plants of both habitats was almost the same except for phenylalanine and leucine which were higher in quantity in the offshore products. The seashore products are more highly valued in the market.

7) *Difference in amino acid composition between one-year old and two-year old plants*

The difference in amino acid composition between one-year old and two-year old plants is very distinct and it is in accordance with the market evaluation; the existence of such difference was reflected in panel judgments. The amino acid composition was distinctly different, i.e., glutamic acid, aspartic acid, serine, threonine, isoleucine, tyrosine, leucine, methionine and tryptophan were higher in two-year old plants, while proline, alanine, valine and histidine were higher in one-year old plants.

8) *Relationship between "kombu" species and amino acid content*

By means of Spearman's method the amino acid contents of eight species (twelve different grades) of *kombu* samples were compared with their quality ranks. The values of the coefficient of rank correlation "rs" are shown in column (8) of Table 60. The value of "rs" lead to the following conclusions: the contents of aspartic acid, glutamic acid, phenylalanine and tryptophan were closely correlated to the quality order presented above in Table 52 of Part 3, (1.6), while the contents of isoleucine, lysine, methionine and tyrosine showed no significant difference in accordance with the quality at the 5% level. All the amino acids except alanine had a positive relation with the quality.

9) Discussion

The above relationships on eight items are discussed further by the following procedures:

In the case of two samples ($n=2$): When an amino acid content of a good quality *kombu* is over two times that of poor one, a mark +1 is given to the comparison of the two samples. When the relationship is reverse, a mark -1 is given to the comparison. When the difference in amino acid content of the two samples is less than the limit, no mark is offered to the comparison.

$n=3, 4$: When the value of "rs" is 1, a mark +1 is given to the comparison, when the value is -1, a mark of -1 is given to it.

$n \geq 5$: When the values of "rs" is significant at the 5% level, a mark +1 or -1 is given to the comparison according to the plus or minus of the "rs" value. When the value of "rs" is significant at 1% level, a mark +2 or -2 is given to the comparison according to the plus or minus of the "rs" value.

Under the above considerations, values were assigned to the comparisons as in Table 60; they were summarized for each amino acid, and Table 61 was obtained.

As seen in Table 61, five positive relations were found for aspartic acid. Therefore a close relation between the aspartic acid content and the flavor of *kombu* is suggested. The taste of aspartic acid, however, is insufficiently good to support this assumption positively.

Alanine, of which the content was high in *kombu* extractive, showed one negative relation. Though a close relationship of alanine with the quality seem to exist, the reason it has to be negative is difficult to explain.

Table 61. Total marks representing evaluations of quality relationships

	Plus	Minus	Total
Alanine		1	-1
Aspartic acid	5		5
Glutamic acid	3	1	2
Glycine	1		1
Histidine	1	1	0
Isoleucine	1	1	0
Leucine		2	-2
Lysine	2	1	1
Methionine	1		1
Phenylalanine	2	3	-1
Proline	1	2	-1
Serine	2	1	1
Threonine	2	1	1
Tryptophan	3	1	2
Tyrosine	1	1	0
Valine		1	-1

Although it showed one negative and three positive relations, glutamic acid, from its high concentration and strong sweet taste, may be a factor in determining the quality of *kombu*.

Though leucine showed reverse relationships twice with the quality, it cannot be a negative factor in respect to influence upon quality, considering its faint taste, its low content and its relatively low solubility in water.

Most of the other amino acids, showing positive and negative relations inconsistently, were present in comparatively lower quantities; they do not taste very good. Therefore their relations with the quality were considered to be not important.

In short, it may be interpreted from Tables 60 and 61 that many amino acids, especially glutamic acid and aspartic acid positively, alanine and leucine negatively, seem to influence the quality. Glutamic acid influences the quality most strongly among the amino acids determined, according to the above evaluation.

5. Effect of glutamic acid on preference of *kombu* extractive

The conclusions in the preceding Part 3, (4) were deduced from the statistical analyses of chemical constituents which seemed to influence the flavor of *kombu*. To confirm the conclusions, sensory tests were carried out as follows:

A panel was organized consisting of from 20 to 50 junior boy-students of the Department of Fisheries Technology, Hokkaido University. They were a little trained prior to tests.

Experimental methods were adopted to the hedonic scale devised by D. R. Peryam⁴⁶⁾; panel checks on the scale of 9 phrases (like or dislike extremely, very much, moderately and slightly and neither like nor dislike) according to his attitude toward a liquid to be tested. Then the checked phrases are numerized; Scores of 9 for the phrase of "like extremely," 5 for "neither like nor dislike," 1 for "dislike extremely" and so on.

An about 2 or 4 cc of prepared sample liquid was served to each of the panel and it was drunk up. The liquids were kept warm at 40 to 50°C, for the period of tests.

Three kinds of *kombu* were used in the tests: *ma-kombu* from Kakkumi in 1960, *mizu-kombu* (a one-year old plant) of *ma-kombu* from Kakkumi in 1960 and *tororo-kombu* from Habomai in 1957.

Three grams of 3 kinds of *kombu* were extracted with 100 cc of boiling water for 5 minutes, then a definite amount of solid sodium chloride was added to make the solutions 1% concentration. Their pH values were about 7. They were served to the panel members. The same tests were repeated 4 times.

To make the concentrations of glutamic acid in the above 3 extractives uniform, 0, 9 and 20.4 mg of glutamic acid were added to each of the 100 cc solutions in the form of monosodium salt, respectively. Tests were also repeated four times. Two results of the fourth tests of the former and later runs are shown schematically in Figure 10.

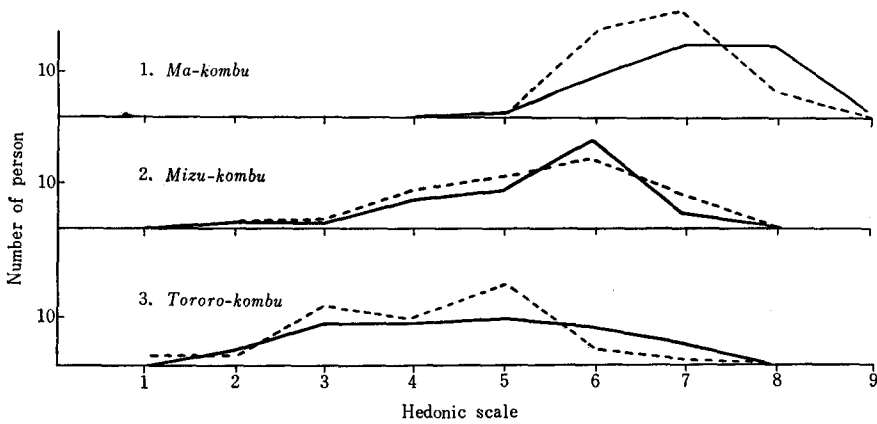

Fig. 10. Preference of 3 kinds of *kombu* extractives on the hedonic scale (Broken lines show the preference of the samples strengthened by the addition of glutamic acid, while full lines show the preference of non-enriched samples.) 1, *Ma-kombu*; 2, *Mizu-kombu*; 3, *Tororo-kombu*

To learn the effect of concentrated glutamic acid on the flavor of *kombu* extractive, 0, 25, 50, 75 and 100 mg glutamic acid were added to each of 100 cc *mizu-kombu* extractives prepared by the same method as above. They were tested three times. The third results are schematically shown in Figure 11.

On the basis of the data graphed in Figures 10 and 11, the following conclusions were reached: In acceptance the three kinds of *kombu* extractives are different to each other. The difference in flavor was not sensibly diminished by

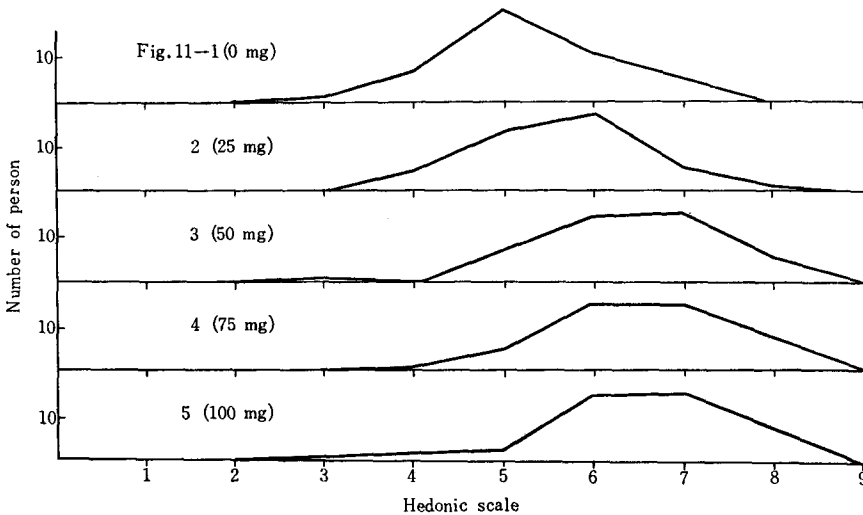

Fig. 11. Preference of *kombu* extractives by the addition of glutamic acid in various concentration. Amounts of glutamic acid added: 1, 0; 2, 25; 3, 50; 4, 75; 5, 100 mg/100 cc

giving the liquids the same concentration of glutamic acid. A large amount of glutamic acid, from 25 to 50 mg per 100 cc *kombu* extractive, improved the flavor of *kombu*, but a limit of efficiency was shown at the concentration of 50 mg glutamic acid per 100 cc *kombu* extractive.

To state the point shortly, though an extractive of *kombu* which is rich in glutamic acid is palatable, a poor taste of *kombu* extract is not improved by enlargement of glutamic acid content, because substances which obstruct the good taste are presumed to exist. Strong enrichment is effective for flavor improvement within a limited range.

5. Conclusions

After a quality order for many kinds of *kombu* had been established, factors influencing the quality were studied. The results obtained suggest a relationship between quality and total nitrogen, amino nitrogen, and glutamic acid. A limited effect of glutamic acid on the flavor was organoleptically recognized. As for the quality of *L. japonica*, plants growing on pebbly beaches of rhyolite were found to be of highest quality.

SUMMARY

Three typical sorts of sea foods in Japan were chosen as samples: in Part 1 fifteen species of flatfish from Hakodate as a representative of fresh fish meats; in Part 2 dried and specially processed skipjack meat, *katsuwo-bushi*, as a representative of a kind of processed fish meat; in Part 3, ten species of edible kelps, *kombu*, as a representative of seaweeds. The general plan of research procedure was as follows: first, quality determination on these samples was carried out; secondly degrees of chemical, physical and biological characteristics of these samples were observed. Lastly, the quality determined first was compared statistically with each characteristic observed in the second procedure. If some relation is proved statistically to exist in the comparison, the characteristic was discussed as to whether it might be a factor which influences the quality.

In Part 1, the 15 species of flatfish were evaluated in three ways: first (2.1), they were ranked according to the calculation of wholesale market price ratio of the flatfish; secondly (2.2), the results of sensory tests on the fish species were analysed in order to make a quality rank; next (2.3), statistical analyses were made of inquiries into the taste of the species of the fish by way of ranking. Finally (2.4) the rankings based on these different ways were analysed. By the analysis, no significant differences among these sets of data were found. The rank by sensory tests was compared with each of the following degrees of characteristics of the flatfish; most of them were observed in this research: (3.1) ecological and morphological characteristics, i.e., spawning season, horizontal and vertical distributions, food habits, fatness and content of edible parts; (3.2) ordinary chemical constituents of food, i.e., moisture, ash, crude fat and crude protein; (3.3) connective tissue, i.e., collagen- and elastin-nitrogens; (3.4) acid-

soluble phosphorus; (3.5) extractive nitrogen-forms and (3.6) seventeen kinds of amino acids of muscle extractive. By the comparison, it was found that fat content is a negative factor to influence the quality of flatfish, whilst quantities of elastin-nitrogen, acid-soluble phosphorus and amino nitrogen of di-amino fraction are positive.

In Part 2, market evaluated grades of several kinds of *katsuwo-bushi* samples were used. After confirmation of the grades by the test panel, they were compared with each the amounts of 17 kinds of amino acids, inosinic acid, adenylic acid, inosine, hypoxanthine and fat. The comparison reveals that the fat content has negative influence on the quality of *katsuwo-bushi* while the content of inosinic acid sometimes has a positive effect.

In Part 3, ten species of *kombu* plants were graded in the following ways: (1.1) taste-testing of water extractive, (1.2) viscosity of water extractive, (1.3) shearing force of boiled blade, (1.4) color of boiled blade and (1.5) thickness of dried plant blade. The grade, as shown in Part 3 (1.6), was compared with each of the extractive nitrogen-forms and each of the 17 kinds of extractive amino acids. As a result of the comparison, it becomes clear that contents of total- and amino-nitrogens and glutamic acid seem to influence the quality. The market evaluations for plants of *ma-kombu* (*Laminaria japonica*) from different growing areas are widely different from each other. Research, carried out through a hydrographical expedition to the *ma-kombu* harvesting areas, reveals that the growing areas of good quality *ma-kombu* are pebbly beaches of rhyolite. The influence of glutamic acid upon the preference of *kombu* extractives was studied organoleptically. As a result of the study, a limited effect on the flavor was recognized at a concentration of glutamic acid over that of natural extractive.

On the basis of the three studies described in Parts 1 to 3, it was observed that sea foods considered to be of poor quality, having unpleasant flavors, sometimes contained tasty compounds in as great a quantity as that in good quality food. This led the suggestion that the quality of sea food is adversely influenced more strongly by poor flavor compounds than it is favorably by good flavor compounds.

LITERATURE CITED

- 1) Simidu, W. (1958). *Suisan-riyogaku*, 400 p. Tokyo; Kanebara-shuppan (in Japanese).
- 2) Dawson, E. H. & Harris, B. L. (1951). *Agriculture Information Bulletin* No. 34 U. S. D. A; Washington D. C.
- 3) Peryam, D. R., Pilgrim, F. J. & Peterson, M. S. (1953). *Food Acceptance Testing Methodology*, 115 p. Chicago; Quartermaster Food & Container Institute for the Armed Forces.
- 4) Terui, G. (1957). *J. Ferment. Tech.*, 35, 467 (in Japanese).
- 5) Mitchell, J. H., Jr. & Leinen, N. J. (1957). *Chemistry of Natural Food Flavors*, 200 p. Chicago; Quartermaster Food & Container Institute for the Armed Forces.
- 6) Arthur D. Little, Inc. (1958). *Flavor Research and Food Acceptance*, 391 p. Cambridge (Mass.); Reinhold Publishing Co.
- 7) Ikeda, K. (1909). *Tokyo-kagaku-kaishi*, 30, 820 (in Japanese).

- 8) Kodama, S. (1913). *Tokyo-kagaku-kaishi*, 34, 751 (in Japanese).
- 9) Oishi, K. (1953-'59). *Bull. Fac. Fish., Hokkaido Univ.*, 9, 171; 9, 186; 10, 57; 10, 131; 10, 246; 10, 251; 10, 254; 10, 319 (in Japanese).
- 10) Oishi, K., Tamura, Y. & Murata, K. (1959). *Bull. Japan. Soc. Sci. Fish.*, 25, 636; 25, 639; 25, 644; 25, 646; 25, 649 (in Japanese).
- 11) Oishi, K., Tamura, Y., Sasaka, K. & Murata, K. (1958). *Bull. Fac. Fish., Hokkaido Univ.*, 9, 283 (in Japanese).
Murata, K., Oishi, K., Tamura, Y., Kanai, E., Wada, Y., Shibata, I. & Kimura, T. (1959). *Ibid.*, 9, 299 (in Japanese).
- 12) Oishi, K., Tamura, Y., Oyamatsu, A., Kanai, E., Okumura, A. & Murata, K. (1961). *Bull. Japan. Soc. Sci. Fish.*, 27, 598 (in Japanese).
Oishi, K., Tamura, Y., Kanai, E., Oyamatsu, A., Okumura, A. & Murata, K. (1961). *Ibid.*, 27, 601 (in Japanese).
- 13) Hikita, T. (1934). *Suisan-kenkyu-iho*, 4, 187 (in Japanese).
- 14) Suisan-cho Chosa-kenkyubu Shiryoka (1949). *Suisancho-chosa-shiryō* No. 8 (in Japanese).
- 15) Masuyama, G. (1950). *Shosurei-no-matomekata*, 144 p. Tokyo; Kawade-shobo (in Japanese).
- 16) Scheffé, H. (1952). *J. Amer. Stat. Assoc.*, 47, 381.
- 17) Ura, S. (1954). *Hinshitsu-kanri*, 5, 32 (in Japanese).
- 18) Yoshikawa, S. (1955). *Miso-gijutsu* No. 29 (in Japanese).
- 19) Pearson, E. S. & Hartley, H. O. (1934-'46). *Biometrika*, 33, 89.
- 20) Terata, K. (1951). *Suisoku-tokeiho*, 213 p. Tokyo; Asakura-shoten (in Japanese).
- 21) Fisher, R. A. & Yates, F. (1953). *Statistical Tables*, 126 p. London; Oliver & Boyd.
- 22) Snedecor, G. W. (1959). *Statistical Methods*, 5th Ed. 534 p. Ames; Iowa State College Press.
- 23) Kendall, M. G. (1955). *Rank Correlation Methods*, 196 p. London; Charles Griffin.
- 24) Uchida, K. (1956). *Sakana*, 201 p. Tokyo; Keio-tsushinsha (in Japanese).
- 25) Kuronuma, K. (1940). *Suisan-kenkyushi*, 35, 211.
- 26) Hatanaka, M., Kosaka, M. & Sato, Y. (1954). *Nihon-seitai-gaku-kaishi*, 4, 133 (in Japanese).
- 27) Hatanaka, M., Kosaka, M., Sato, Y., Yamaki, K. & Fukui, K. (1954). *Tohoku J. Agri. Res.*, 5, 177.
- 28) Moiseev, P. A. (1953). *Izvestia TINRO*, 40 (1), (2) (Translated into Japanese by Hokuyo-shigen Kenkyu-kyogikai).
- 29) Simidu, W. (1947). *Bull. Japan. Soc. Sci. Fish.*, 13, 27 (in Japanese).
- 30) Oya, T. & Kurakake, T. (1935). *Bull. Japan. Soc. Sci. Fish.*, 4, 195 (in Japanese).
- 31) Tsuchiya, Y. & Takahashi, I. (1950). *Tohoku J. Agri. Res.*, 1, 209.
- 32) Anderson, E. E. & Fellers, C. R. (1955). *Food Tech.*, 9, 80.
- 33) Sekine, T., Kasuga, S. & Nozui, G. (1953). *Hyojun-seikagaku-jikkenho (Rinsan-bunkaku-teiryoho)*, 625 p. Tokyo; Bunkodo (in Japanese).
- 34) Schurr, P. E., Thompson, H. T., Henderson, L. M. & Elvehjem, C. A. (1950). *J. Biol. Chem.*, 182, 29.
- 35) Tamura, G., Tsunoda, T., Kirimura, J. & Miyazawa, S. (1952). *J. Agri. Chem. Soc. Japan*, 26, 464 (in Japanese).
- 36) Matsuura, F., Konosu, S., Ota, R., Katori, S. & Tanaka, K. (1955). *Bull. Japan. Soc. Sci. Fish.*, 20, 941 (in Japanese).
- 37) Moore, S. & Stein, W. H. (1951). *J. Biol. Chem.*, 192, 663.
- 38) Konosu, S. & Hashimoto, Y. (1959). *Bull. Japan. Soc. Sci. Fish.*, 25, 307 (in Japanese).
- 39) Konosu, S., Maeda, Y. & Fujita, T. (1960). *Ibid.*, 26, 45 (in Japanese).
- 40) Saito, T. & Arai, K. (1958). *Arch. Biochem. Biophys.*, 73, 315.
- 41) Yoshikawa, Y. (1940). *Fushirui*, 44 p. Tokyo; Koseikaku (in Japanese).

- 42) Okamura, K. (1936). *Nihon-kaisoshi*, 964 p. Tokyo; Uchida-rokakuho (in Japanese).
- 43) Nakagawa, K. (1956). *Kombu*, 237 p. Hakodate; Hokkai-suisan Shinbun (in Japanese).
- 44) Wada, S. (1954). *Guide to Color Standard*, Tokyo; Nihon-shikisai-kenkyusho.
- 45) Hokkaido Dobokubu (1954). *Hokkaido-chishitsuzu*, Sapporo; Hokkaido-chikashigen-chosabu.
- 46) Peryam, D. R. & Girardot, N. F. (1952). *Food Eng.*, 24, 58.