



Title	COMPARATIVE OSTEOLOGY AND MYOLOGY OF THE SUPERFAMILY COTTOIDEA (PISCES: SCORPAENIFORMES), AND ITS PHYLOGENETIC CLASSIFICATION)
Author(s)	YABE, Mamoru
Citation	MEMOIRS OF THE FACULTY OF FISHERIES HOKKAIDO UNIVERSITY, 32(1), 1-130
Issue Date	1985-03
Doc URL	http://hdl.handle.net/2115/21877
Type	bulletin (article)
File Information	32(1)_P1-130.pdf



[Instructions for use](#)

COMPARATIVE OSTEOLOGY AND MYOLOGY OF THE SUPERFAMILY
COTTOIDEA (PISCES : SCORPAENIFORMES),
AND ITS PHYLOGENETIC CLASSIFICATION

By

MAMORU YABE

*Laboratory of Marine Zoology, Faculty of Fisheries,
Hokkaido University, Hakodate, Japan*

Contents

	Page
I. Introduction	1
II. Materials and methods	3
III. Acknowledgments	6
IV. Systematic methodology	6
1. Recognition of the monophyletic group	6
2. Determination of the polarity of the character	7
3. Inference of the branching pattern	8
V. Comparative osteology	10
1. Circumorbital bones	10
2. Cranium	16
3. Jaws	30
4. Suspensorium and opercular bone	33
5. Hyoid apparatus	40
6. Branchial apparatus	44
7. Pectoral girdle	48
8. Pelvic girdle	54
9. Postcranial axial skeleton	57
10. Median fin supports	59
11. Caudal skeleton	63
VI. Comparative myology	67
1. Muscles of the cheek	67
2. Muscles serving the hyoid arch	72
3. Muscles serving the branchial arch	77
4. Muscles serving the pectoral fin	83
5. Muscles serving the pelvic fin	87
6. Body muscle	89
7. Muscles serving the caudal fin	92
8. Muscles of the swimbladder	94

The present work was submitted as a partial fulfillment of the requirements for Doctor's degree in Fisheries Science at Hokkaido University in 1984.

9. Muscles between the pectoral girdle and the cranium, the hyoid and the branchial arches	97
VIII. Phylogenetic classification of the superfamily Cottoidea	99
1. Characters and conditions	99
2. Monophyly of the cottoid fishes	107
3. Relationships among the cottoid families	108
4. Branching pattern of each cottoid family	111
1) Family Cottidae	111
2) Family Hemitripterae	117
3) Family Agonidae	118
4) Family Psychrolutidae	119
5) Family Ereuniidae	120
6) Family Rhamphocottidae	120
5. General consideration	121
VIII. Summary	123
IX. Literature cited	125

I. Introduction

The fishes of the superfamily Cottoidea inhabit various the fresh water and marine habitats in the boreal and temperate waters of the Northern Hemisphere. Several marine species are also known from the Southern Hemisphere. In this group there are about 380 species and 98 genera in the world.

The systematics of cottoid fishes has been studied by many investigators (Gill, 1889; Regan, 1913; Johnson, 1918; Matsubara, 1936; Berg, 1940; Taranetz, 1941; Bolin, 1947; Matsubara, 1955; Taliev, 1955; Watanabe, 1958; Quast, 1965; Cowan, 1972; Neelov, 1976, 1979; Yabe, 1981, 1983; Nelson, 1982; Sideleva, 1982). Through these studies, various families have been established by each investigator. Gill (1889) recognized the superfamilies Cottoidea, Rhamphocottoidea and Agonoidea, and included two families, Cottidae and Hemitripterae, in the superfamily Cottoidea on the basis of some osteological characters. Regan (1913) recognized six families, Cottidae, Cottunculidae, Psychrolutidae, Comephoridae, Agonidae and Cyclopteridae, in the division Cottiformes. Berg (1940) reviewed previous works and recognized nine families in his superfamily Cottoidea: Icelidae, Cottidae, Cottocomephoridae, Comephoridae, Normanichthyidae, Cottunculidae, Psychrolutidae, Agonidae and Cyclopteridae. From the examination of a great number of the cottoid fishes, Taranetz (1941) established 12 families characterized by external and some osteological characters; Ascelichthyidae, Cottidae, Cottocomephoridae, Comephoridae, Hemitripterae, Blepsiidae, Psychrolutidae, Ereuniidae, Marukawichthyidae, Rhamphocottidae, Synchiriidae and Agonidae. He also included 13 subfamilies in the family Cottidae. Matsubara (1955) classified Japanese cottoid fishes into two superfamilies Cottoidea (Cottoidea) with two families Cottidae and Psychrolutidae, and the Agonicea (Agonoidea) with two families Agonidae and Aspidophoridae. Watanabe (1958) regarded the Japanese cottoid fishes as a single family Cottidae with 13 subfamilies. Thus, there is no agreement in the classification at the familial level. The disagreement between

previous examinations have been caused by the examination of too few species and too few morphological characters.

The purposes of the present study are to clarify the monophyly of the superfamily Cottoidea, and to infer the phylogenetic interrelationships of this superfamily on the basis of as many species, and osteological and myological characters as possible, and to establish the phylogenetic classification in this superfamily. Recently, the phylogenetic significance of myological characters is discussed in several fish groups (Greenwood et al., 1966; Liem, 1970, 1978, 1981; Greenwood, 1971, 1981; Winterbottom, 1974a, b; Kershaw, 1976; Howers, 1976, 1980; Liem and Greenwood, 1981 etc.). However myological conditions have not been examined in cottoid fishes. In the present study, the myological characters of cottoid and other scorpaeniform fishes are described in detail, and are used for the consideration of the phylogenetic relationships as well as the osteological characters. In order to estimate the phylogenetic relationships of the present fish group, the cladistic approach, whose fundamental philosophy is formulated by Hennig (1966), is adopted.

II. Materials and Methods

The specimens examined for the present study are listed with their catalogue numbers and sizes. The abbreviations prefixed to the catalogue numbers indicate the following institutions where those specimens belong:

- BCPM : British Columbia Provincial Museum, Victoria
 CAS : California Academy of Sciences, San Francisco
 FAKU : Faculty of Agriculture, Kyoto University, Kyoto
 HUMZ : Laboratory of Marine Zoology, Faculty of Fisheries, Hokkaido University, Hakodate
 NMC : National Museums of Canada, Ottawa
 SU : Natural History Museum, Stanford University, now housed as CAS
 UW : College of Fisheries, University of Washington, Seattle

Cottidae

- Alcichthys alcornis*, HUMZ 42297, 59095, 2 specimens, 156-205 mm SL
Argyrocottus zanderi, HUMZ 59345, 59346, 2 specimens, 39-52 mm SL
Artediellus dydymovi, HUMZ 45609, 53383, 59348, 3 specimens, 59.4-78.3 mm SL
Artediellichthys nigripinnis, HUMZ 54976, 1 specimen, 102 mm SL
Aretedius haringtoni, HUMZ 77123, 1 specimen, 82 mm SL
Ascelichthys rhodorus, SU 16664, 1 specimen, 84.8 mm SL
Asemichthys taylori, HUMZ 86582, 1 specimen, 40.8 mm SL
Astrocottus mastubarai, HUMZ 101130, 1 specimen, 34 mm SL
Bero elegans, HUMZ 41942, 52888, 52898, 3 specimens, 64.2-71.2 mm SL
Chitonotus pugetensis, NMC 79-587, 1 specimen, 89 mm SL
Clinocottus globiceps, BCPM 974-454, 1 specimen, 116 mm SL
Cottiusculus gonetz, HUMZ 56930, 1 specimen, 65.2 mm SL
Cottus kazika, HUMZ 36471, 1 specimen, 171.8 mm SL
Cottus pollux, HUMZ 43303, 1 specimen, 140 mm SL
Enophrys diceratus, HUMZ 40900, 101132, 2 specimens, 118-121 mm SL
Furcina oshimai, HUMZ 59522, 1 specimen, 49 mm SL

- Gymnocanthus galeatus*, HUMZ 46162, 1 specimen, 178 mm SL
Gymnocanthus herzensteini, HUMZ 40904, 53989, 2 specimens, 178-245 mm SL
Gymnocanthus intermedius, HUMZ 59010, 1 specimen, 137 mm SL
Hemilepidotus gilberti, HUMZ 56847, 56866, 2 specimens, 213-249 mm SL
Hemilepidotus papilio, HUMZ 56337, 76941, 2 specimens, 230-258 mm SL
Icelinus borealis, NMC 64-258, 1 specimen, 55 mm SL
Icelinus tenuis, NMC 64-805, 1 specimen, 107 mm SL
Icelus canaliculatus, HUMZ 82954, 1 specimen, 120 mm SL
Icelus spiniger, HUMZ 56086, 56091, 56092, 56906, 4 specimens, 133-194 mm SL
Icelus uncinalis, HUMZ 76835, 76838, 2 specimens, 75-119 mm SL
Jordania zonope, CAS 27907, 1 specimen, 65 mm SL
Leiocottus hirundo, CAS 20295, 1 specimen, 176.7 mm SL
Leptocottus armatus, HUMZ 77173, 101131, 2 specimens, 227-235 mm SL
Microcottus sellaris, HUMZ 69119, 1 specimen, 60 mm SL
Myoxocephalus brandti, HUMZ 62238, 1 specimen, 135.8 mm SL
Myoxocephalus jaok, HUMZ 45874, 1 specimen, 247 mm SL
Myoxocephalus polyacanthocephalus, HUMZ 56895, 1 specimen, 266 mm SL
Myoxocephalus stelleri, HUMZ 40828, 1 specimen, 147 mm SL
Ocymectes maschalis, HUMZ 72295, 1 specimen, 71.6 mm SL
Oligocottus maculosus, HUMZ 75596, 1 specimen, 74.6 mm SL
Orthonopias triacis, CAS 15269, 1 specimen, 66 mm SL
Porocottus alhisi, HUMZ 58384, 59348, 59349, 3 specimens, 42-59 mm SL
Pseudoblennius cottoides, HUMZ 40961, 59515, 2 specimens, 83-98 mm SL
Pseudoblennius percoides, HUMZ 49016, 59097, 2 specimens, 169-174 mm SL
Radulinus asprellus, NMC 65-222, 1 specimen, 73 mm SL
Ricuzenius pinetorum, HUMZ 66086, 1 specimen, 54 mm SL
Ricuzenius toyamensis, HUMZ 53915, 65661, 2 specimens, 88.6-104.9 mm SL
Scorpaenichthys marmoratus, UW 821, 1 specimen, 112 mm SL
Stlengis osensis, HUMZ 80001, 1 specimen, 39 mm SL
Stelgistrum stejneri, HUMZ 86555, 1 specimen, 72.8 mm SL
Synchirus gilli, BCPM 978-33, 1 specimen, 46.3 mm SL
Taurocottus bergi, HUMZ 67702, 1 specimen, 131 mm SL
Taurulus bubalis, HUMZ 101134, 1 specimen, 86 mm SL
Thyriscus anoplus, HUMZ 88548, 1 specimen, 106.9 mm SL
Trachidermus fasciatus, HUMZ 74749, 1 specimen, 94.8 mm SL
Trichocottus brashnicovi, HUMZ 54218, 1 specimen, 149 mm SL
Triglops macellus, BCPM 9979-11022, 1 specimen, 127.5 mm SL
Triglops pingeli, HUMZ 56396, 56397, 2 specimens 127-132 mm SL
Triglops scepticus, HUMZ 46150, 56149, 56151, 56308, 4 specimens, 143-177 mm SL
Vellitor centropomus, HUMZ 59506, 59507, 2 specimens, 81-82 mm SL
Zesticelus profundorum, HUMZ 81867, 1 specimen, 50.2 mm SL
Hemitripterae
Blepsias cirrhosus, HUMZ 52829, 75797, 2 specimens, 152-169 mm SL
Hemitripteris villosus, HUMZ 40903, 65803, 68478, 3 specimens, 66-256 mm SL
Hemitripteris bolini, HUMZ 77038, 1 specimen, 174.3 mm SL
Nautichthys pribilovius, HUMZ 69126, 1 specimen, 72.5 mm SL
Nautichthys oculo-fasciatus, HUMZ 89870, 1 specimen, 72 mm SL
Agonidae
Agonomalus jordani, HUMZ 33258, 1 specimen, 183 mm SL
Podothecus sachi, HUMZ 90594, 1 specimen, 326 mm SL
Tilesina gibbosa, HUMZ 90593, 1 specimen, 233 mm SL
Psychrolutidae

Cottunculus granulosis, HUMZ 101133, 1 specimen, 158 mm SL
Dasycottus setiger, HUMZ 45641, 45955, 2 specimens, 205-225 mm SL
Ebinania brephocephala, HUMZ 51822, 75460, 2 specimens, 88-94 mm SL
Ebinania vermiculata, HUMZ 72590, 1 specimen, 222.6 mm SL
Eurymen gyrinus, HUMZ 40915, 1 specimen, 269 mm SL
Malacocottus gibber, HUMZ 53652, 1 specimen, 175 mm SL
Malacocottus zonurus, HUMZ 44920, 51677, 2 specimens, 185-193 mm SL
Neophrynichthys latus, HUMZ 66486, 1 specimen, 156 mm SL
Psychrolutes phrictus, HUMZ 78319, 1 specimen, 287 mm SL
 Ereuniidae
Ereunias grillator, HUMZ 5672-5675, 49488, 5 specimens, 81-262 mm SL
Marukawichthys ambulator, HUMZ 59313, 59315, 77522, 3 specimens, 91-128 mm SL
Marukawichthys pacificus, HUMZ 68660, 1 specimen, 234 mm SL
 Rhamphocottidae
Rhamphocottus richardsoni, UW 2210, 10216, 2 specimens, 20-67 mm SL

Other scorpaeniform fishes

Scorpaenidae

Apistus carinatus, HUMZ 48141, 1 specimen, 98 mm SL
Helicolenus hilgendorfi, HUMZ 79402, 1 specimen, 128 mm SL
Hypodytes rubripinnis, HUMZ 39612, 1 specimen, 87 mm SL
Pterois lunulata, HUMZ 87822, 1 specimen, 134 mm SL
Sebastolobus alascanus, HUMZ 82853, 1 specimen, 240 mm SL
Setarches longimanus, HUMZ 79470, 1 specimen, 134.5 mm SL

Synanceiidae

Minous monodactylus, HUMZ 79277, 1 specimen, 109 mm SL
Inimicus japonicus, HUMZ 79103, 1 specimen, 104 mm SL

Platycephalidae

Onigocia macrolepis, HUMZ 79117, 1 specimen, 107.7 mm SL

Bembridae

Bembras japonicus, HUMZ 80027, 1 specimen, 125.3 mm SL

Hoplichthyidae

Hoplichthys gilberti, HUMZ 79967, 1 specimen, 120 mm SL

Triglidae

Lepidotrigla microptera, HUMZ 51892, 1 specimen, 159 mm SL
Chelidonichthys spinosus, HUMZ 65245, 1 specimen, 214 mm SL

Anoplopomatidae

Anoplopoma fimbria, HUMZ 76773, 1 specimen, 243 mm SL
Erilepis zonifer, HUMZ 87882, 1 specimen, 146 mm SL

Hexagrammidae

Hexagrammos octogrammus, HUMZ 85852, 1 specimen, 180 mm SL
Hexagrammos stelleri, HUMZ 69947, 1 specimen, 160 mm SL
Oxylebiscus pictus, CAS 45609, 1 specimen, 135 mm SL
Pleurogrammus azonus, HUMZ 47916, 1 specimen, 286 mm SL

Zaniolepididae

Zaniolepis frenata, CAS 31392, 1 specimen, 113 mm SL
Zaniolepis latipinnus, CAS 15979, 1 specimen, 152 mm

Cyclopteridae

Aptocyclus ventricosus, HUMZ 42484, 1 specimen, 192 mm SL
Eumicrotremus birulai, HUMZ 55243, 55586, 2 specimens, 67-128 mm SL

Liparididae

Liparis tessellatus, HUMZ 58639, 1 specimen, 144 mm SL.

These specimens were dissected after being stained with alizarin red-S, and observed with a binocular microscope. For osteological observations, several materials were cleared and stained. The drawings of the bones and muscles were made with the Wild M-8 drawing tube. The terminology used here chiefly follows that used most modern ichthyologists (e.g. Monod, 1967; Nelson, 1969; Liem, 1970) for the osteology, and Winterbottom (1974a) for the myology.

III. Acknowledgments

I wish to express my sincere gratitude to the late Dr. Takao Igarashi, the professor of Hokkaido University, for his guidance in the course of present study and critical reading of the manuscript. I wish to thank Dr. Keikichi Hamada, the professor of the same university, for critical reading of the manuscript. Also, I wish to thank Dr. Seikichi Mishima, the professor of the same university, for critical reading of the manuscript. I wish to express the deepest appreciation to Dr. Kunio Amaoka, the professor of the same university and Dr. Joseph S. Nelson, the professor of the University of Alberta, Canada, for their valuable advice and critical reading of the manuscript.

I am deeply indebted to the following people for their kind assistance and for the gift or loan of materials: Mr. Koji Abe of Hokkaido Fisheries Experimental Station at Wakkanai; Dr. Daniel M. Cohen of Los Angeles County of Sciences; Drs. William N. Eschmeyer and Tomio Iwamoto of California Academy of Sciences; Dr. Hiroshi Hatanaka and Mr. Kiyoshi Wakabayashi of Far Seas Fisheries Research Laboratory, Mr. Masayoshi Hayashi of Yokosuka City Museum, Drs. Tamotsu Iwai, Izumi Nakamura and Tetsuji Nakabo of Kyoto University; Dr. Don E. McAllister of National Museum of Natural Sciences, Canada; Mr. Shuka Maruyama of Hokkaido Fisheries Experimental station at Muroran; Dr. Keiichi Matsuura of National Science Museum at Tokyo; Dr. Douglas W. Nelson of University of Michigan; Dr. Alex E. Peden of British Columbia Provincial Museum; Dr. Yoshiaki Tominaga of University of Tokyo; Dr. Mitsugu Toyoshima of ECEC at Sapporo. Finally, my special thanks go to Mr. Tsutomu Kanayama of Sogo-kagaku Co. Ltd. at Osaka and Mr. Kaoru Kido of Hokkaido University for giving valuable knowledge in the agonid and liparidid fishes, and also to Dr. Kazuhiro Nakaya and Dr. Kazuo Sakamoto of Hokkaido University, Dr. Yukio Sawada of Seibu College of Medical Technology, Mr. Takeshi Shimizu and the graduate students of Laboratory of Marine Zoology of Hokkaido University for discussing fish phylogeny and giving valuable advice.

IV. Systematic methodology

1. RECOGNITION OF THE MONOPHYLETIC GROUP

In this study, the phylogenetic relationships among the cottoid fishes are inferred by the cladistic approach whose fundamental philosophy is formulated by Hennig (1966). It is summarized that the monophyletic group is recognized only by the shared derived condition of the character. The term of monophyletic group

used here is the sense of the paraphyletic group defined by Ashlock (1971), "a monophyletic group that does not contain all of descendants", because in this study not all cottoid fishes are examined. Therefore the monophyletic group used here is a group that contains a common ancestor and its all known (examined) descendants. In this study, the monophyletic group is recognized not only by shared unique derived condition of the character (autapomorphy) but also by the shared combination of each derived condition of the character (synapomorphy), when the shared combination is unique among the examined group.

2. DETERMINATION OF THE POLARITY OF THE CHARACTER

In this study, the polarity of each character in the cottoid fishes is determined on the basic assumption that the conditions in the recent species of the group inferred by previous studies to be the ancestral group to cottoid fishes show the ancestral conditions of the characters of the cottoid fishes. The ancestral group of the cottoid fishes is inferred from the literature. There are three interpretations about the origin of the cottoid fishes. The first is that the cottoid fishes are derived from the generalized scorpaenid type ancestor which may be one of the derivatives of the generalized percoid fishes. Since the outline of the recent classification of the scorpaeniform fishes was proposed by Gill (1889), this interpretation has been inherited by many ichthyologists (Allis, 1909; Regan, 1913; Berg, 1940; Taranetz, 1941; Matsubara, 1943; Bolin, 1947). The second is a hexagrammid-zaniolepidid-cottid lineage suggested by Quast (1965). On the base of the osteological data, he inferred that the scorpaeniform fishes may be the polyphyletic groups including the scorpaenid, anoplopomatid and hexagrammid-zaniolepidid-cottid lineages. This hypothesis has been supported by Freihofer (1963). He clarified that three distributional patterns of the nerve of ramus lateralis accessorius (scorpaenid type, anoplopomatid type and hexagrammid-cottid-cyclopterid type) are present in the scorpaeniform fishes. It has been considered that the hexagrammid-cottid-cyclopterid type could have been derived from the unique pattern in a percichthyid genus *Roccus* and its near allies. The scorpaenid type could be derived from a widespread percoid pattern that typifies most species of the family Serranidae, and the anoplopomatid type is tentatively regarded as being closest to that of the gadoid fishes. The third interpretation assumed by Watanabe (1958) is that the cottoid fishes may have developed parallel with the scorpaenid fishes and have been separated from the main stem of the percoid earlier than the latter. The greatest common measure of these three interpretations is regarded that the cottoid fishes may be derived from the generalized percoid-type ancestor.

On the basis of this interpretation, the basic assumption that the ancestral condition of each character in the cottoid fishes is represented by the condition in the generalized percoid fishes is made. Some examples of the determination of the polarity of each character are summerized in Fig. 1. When one condition of a certain character is present in the generalized percoid fishes, the condition is regarded as the ancestral condition of the cottoid fishes. In this case, if one of some conditions in the cottoid fishes is same to that in the generalized percoid fishes, it is regarded as the most primitive condition in the cottoid fishes (Fig. 1, A and B); if the conditions in the cottoid fishes are not the same as that in the generalized percoid fishes,

the condition which is most similar to that of the generalized percoid fishes is regarded as the most primitive condition in the cottoid fishes (Fig. 1, C). When two or more conditions are present in a certain character of the percoid fishes, all of these conditions are regarded as the ancestral condition for the cottoid fishes (Fig. 1, D and E). If the all conditions of a certain character in the cottoid fishes are also present in the generalized percoid fishes, the polarity of this character is not decided, and this character is not used in the inference of the branching pattern (Fig. 1, D).

<p>A</p> <p style="padding-left: 40px;">1 → 2 → 3</p> <p>Percoïd 0 - -</p> <p>Cottoid 0 0 0</p>	<p>B</p> <p style="padding-left: 40px;">1 ← 2 → 3</p> <p>Percoïd - 0 -</p> <p>Cottoid 0 0 0</p>
<p>C</p> <p style="padding-left: 40px;">1 2 3 → 4</p> <p>Percoïd 0 - - -</p> <p>Cottoid - - 0 0</p>	<p>D</p> <p style="padding-left: 40px;">1 = 2</p> <p>Percoïd 0 0</p> <p>Cottoid 0 0</p>
<p>E</p> <p style="padding-left: 40px;">1 = 2 → 3 → 4</p> <p>Percoïd 0 0 - -</p> <p>Cottoid 0 0 0 0</p>	

Fig. 1. Determination of the polarity of the character. 1, 2, 3 and 4; the condition of each character. O, presence of this condition; -, absence of this condition. Arrows indicate the evolutionary trend of each character. For explanation, see text.

3. INFERENCE OF THE BRANCHING PATTERN

Hennig (1966) stated that "the greater the number of the autapomorphic characters that can be demonstrated the greater the certainty that the group is the monophyletic". This statement has been considered as the greatest principle with the parsimony, when the branching pattern is inferred (Nelson, 1971; Vari, 1976; Wiley, 1978; Matsuura, 1979; Sawada, 1982; etc.). But, it is considered that this principle is one of the operational principles based on the conception of the synapomorphy which is that the monophyletic group is recognized only by the synapomorphy not by the overall similarities. This conception is based on the speciation model theoretically explained by Hennig (1966) and is based on the transformation of the characters. It is considered that this model is the most reasonable as the morphological explanation of the speciation. On the basis of this speciation model, the conception of the synapomorphy is suggested as the recognition of the monophyletic group. The conception of the synapomorphy approved of the monophyletic group which is recognized by only a synapomorphy. It, therefore, is considered that the number of the synapomorphies is the one of the operational principles which check the certainty of the monophyletic group. But in the most of the cladistical works, this principle is emphasized as only a principle for the inference of the branching pattern, but the speciation model based on the transfor-

mation of the character is not regarded. It is considered that the transformation of the character can be used as the indicator which checks the certainty of the monophyletic group inferred by the conception of the synapomorphy as well as the number of synapomorphies.

On the other hand, Camin and Sokal (1965) exhibited the monothetic method. This method is summarized that the branching pattern is inferred on the basis of the transformation of the character, and the certainty of the branching pattern is concluded by the principle of the parsimony. It is considered that the monothetic method is more faithfully reflected the transformation of the characters in the branching pattern than other method, though the conception of the synapomorphy is not regarded. But this method has been appraised high in regard to the principle of the parsimony, and yielded several numerical cladistic methods with various modifications based on the parsimony principle (Kluge and Farris, 1969; Farris, 1970; etc.). In these modified methods, the parsimony is the greatest principle for inferring the branching patterns. It has been considered that the parsimony is a general axiom accepted by most phylogeneticists as an operating principle in the interpretation of the data (Nelson, 1971; Hecht and Edwaeds, 1977). But the parsimony principle is no more than a selection rule for plural possibilities inferred on the basis of a certain theoretical principle, and it must not precede the theoretical principle, because the parsimony principle is not based on the theoretical endorsement. It, therefore, is considered that the method in which the parsimony is regarded as the greatest principle produces only the operational result based on no theoretical endorsement on evolution.

Under these considerations, the branching patterns are inferred by the following procedure. The branching pattern is inferred by the conception of the synapomorphy, and the certainty of the branching pattern is checked on the basis of the transformation of the character and the number of the synapomorphies. The principle of the parsimony is used when the plural possibilities are inferred. An example of the inferring of the branching pattern on the basis of the present method is shown in Fig. 2.

i) when the taxon A possesses all derived conditions of the most primitive taxon P which is concluded as a possessor of minimum number of the derived conditions, it is regarded as the member of the monophyletic group including the taxon P.

ii) when the taxon B does not possess all derived conditions of the taxon P, it is not regarded as the member of the monophyletic group including the taxon P.

iii) the relationships between the taxa B and P is inferred from the hypothetical taxon H which possesses the derived condition being common to the both taxa.

iv) when the taxon C possesses all derived conditions of the taxa A and B, it is regarded as the member of the monophyletic group of the taxon B which shares more number of the derived conditions with the taxon C than the taxon A.

v) when plural branching patterns which is satisfied above conditions are inferred, the branching pattern which is possessed of minimum evolutionary steps is selected.

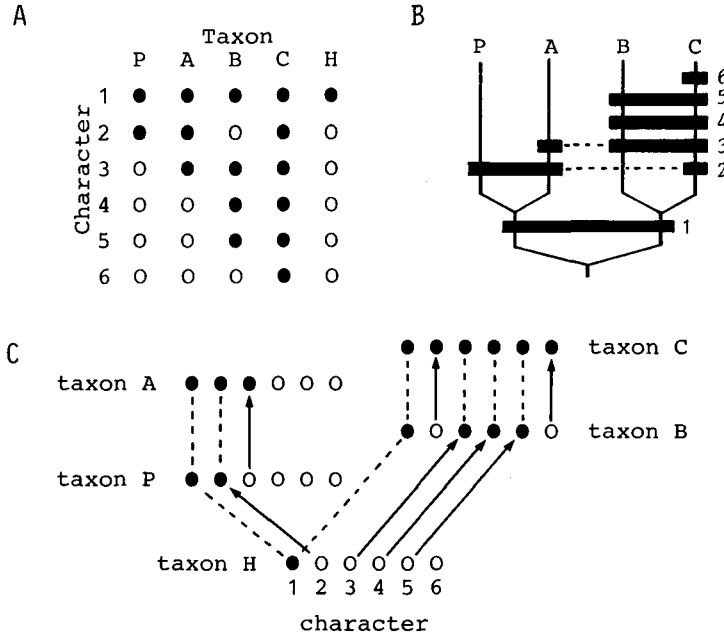

Fig. 2. Determination of the branching pattern. A, conditions of six characters among four taxa (P, A, B and C) and a hypothetical taxon (H). Open circles refer to primitive conditions. Solid circles indicate derived conditions. B, branching pattern inferred by the method of the present study with synapomorphies of each branch. C, Hypothetical transformation of character condition. Open circles indicate primitive conditions. Solid circles indicate derived conditions.

V. Comparative osteology

1. CIRCUMORBITAL BONES (Figs. 3-5; Table 1)

Description. In the cottoid fishes, the circumorbital bones are composed of the lachrymal and the infraorbitals. They form a serial tubular structure for the infraorbital sensory canal.

Lachrymal (LA): The lachrymal is a large plate-like bone situated on the lateral side of the snout region. This bone is possessed of an articular facet dorsally where it articulates with the prefrontal, and an articular knob dorsomedially where it is received in the lateral groove of the palatine to form the lachryopalatine articulation. The lachrymal attaches to the anterior process of the palatine anterodorsally, and is sutured with the first infraorbital posteriorly.

Infraorbital (IO): The first and second infraorbitals are large plate-like bones generally. They are sutured each other and form the ventral margin of the orbit. The second infraorbital is elongated posteriorly, and attached or closely situated to the lateral margin of the preopercle to form the suborbital stay. In the fishes of the family Agonidae examined here, the suborbital stay is well developed and almost entirely covers the cheek region. The posterior three infraorbitals are small tubular

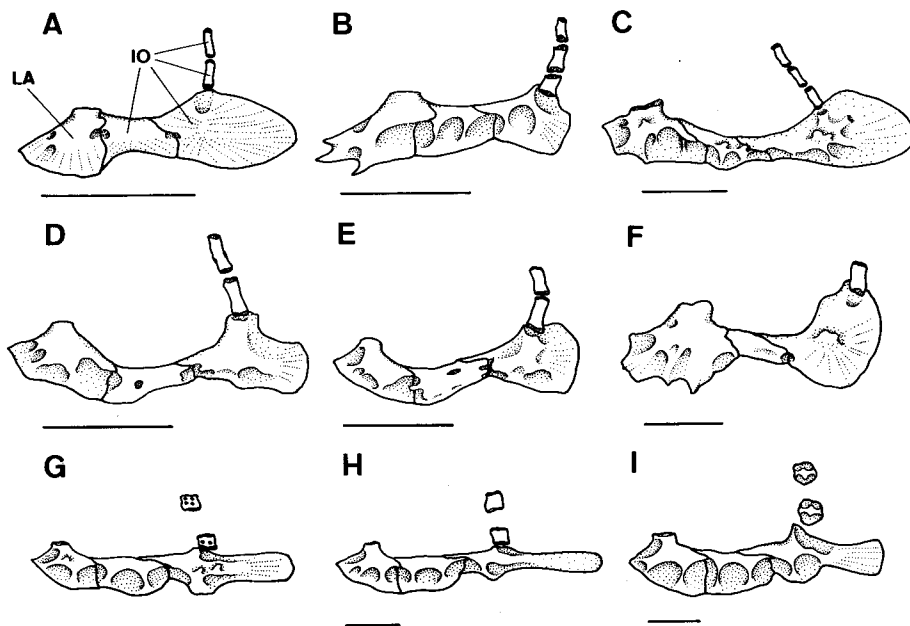

Fig. 3. Lateral aspects of left circumorbital bones of 9 cottoid fishes. A, *Rhamphocottus richardsoni*; B, *Marukawichthys ambulator*; C, *Hemitripterus villosus*; D, *Blepsias cirrhosus*; E, *Nautichthys oculofaciatus*; F, *Agonomalus jordani*; G, *Dasycottus setiger*; H, *Eurymen gyrinus*; I, *Malacocottus gibber*. IO, infraorbital; LA, lachrymal. Scales indicate 5 mm.

bones. Among the cottoid fishes examined, the number of the infraorbitals is changed and divided into three types. Type A is the condition with five infraorbitals. This condition is observed in the fishes of the family Ereuniidae, the hemitriptid genus *Hemitripterus*, the cottid genera *Hemilepidotus*, *Jordania*, *Scorpaenichthys*, *Cottus*, *Trachidermus*, *Leptocottus*, *Oligocottus*, *Clinocottus*, *Artedius*, *Orthonopias*, *Chitonotus*, *Leiocottus*, *Gymnocanthus*, *Synchirus*, *Icelus*, *Icelinus*, *Ricuzenius*, *Stelgistrum*, *Silengis*, *Alcichthys*, *Bero*, *Ocynectes*, *Furcina*, *Pseudoblennius*, and *Vellitor*. Type B is the condition possessing four infraorbitals which are composed of two plate-like bones and two tubular bones. This condition is observed in the fishes of family Rhamphocottidae, the hemitriptid genera *Blepsias* and *Nautichthys* and the cottid genera *Radulinus*, *Asemichthys*, *Astrocottus*, *Thyriscus*, *Ascelichthys*, *Triglops*, *Taurocottus*, *Trichocottus*, *Myoxocephalus*, *Porocottus*, *Argyrocottus*, *Microcottus*, *Enophrys*, *Taurulus*, *Artediellus*, *Artediellichthys*, *Cottiusculus* and *Zesticelus*, and the psychrolutid fishes except for a genus *Cottunculus*. Type C is the condition having three infraorbitals which are composed of two plate-like bones and a tubular bone. This condition is observed in the fishes of the family Agonidae and a psychrolutid fishes *Cottunculus*. In the agonid fishes, the tubular bone is connected with both the sphenotic and the second infraorbital. In *Cottunculus*, the tubular bone lies nearly to the sphenotic and is far separated from the second infraorbital.

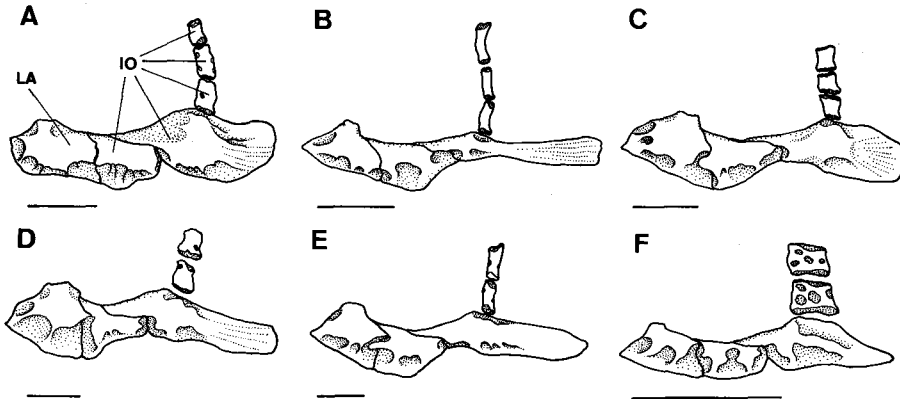

Fig. 4. Lateral aspects of left circumorbital bones of 6 cottid fishes. A, *Hemilepidotus gilberti*; B, *Cottus pollux*; C, *Alcichthys alcicornis*; D, *Trichocottus brashnicovi*; E, *Myoxocephalus setelleri*; F, *Artediellus dydymovi*. For abbreviation, see Fig. 3. Scales indicate 5 mm.

Infraorbital sensory canal (SC): Among the cottoid fishes examined, the distributional pattern of the infraorbital sensory canal is sharply defined into two types. Type A is represented by most of the cottoid fishes except for the psychrolutid fishes. In this type, the infraorbital sensory canal which is branched from the supraorbital sensory canal at the sphenotic passes through the third to fifth infraorbitals and enters into the second infraorbital where the canal is branched into two ways: the anterior branch extends forward to the lachrymal, and the posterior branch extends backward (Fig. 5, A). Type B is represented by all psychrolutid fishes. In this type, the infraorbital sensory canal is branched into two ways after it passes through the fourth infraorbital. One of these branches runs backward, and is continued to the operculomandibular sensory canal. The another branch extends downward to enter into the second infraorbital bone (Fig. 5, B).

Discussion. The circumorbital bones of the cottoid fishes have been described by Girard (1852), Gill (1889), Allis (1909), Johnson (1918), Matsubara (1936), Taranetz (1941), Quast (1965), Cowan (1971), Watanabe (1958), Yabe (1981, 1983) and Nelson (1982). In their studies, the number of the infraorbitals and the condition of the suborbital stay have been remarked. In the present study, the differences within the cottoid fishes are found in the number of the infraorbitals and the distributional pattern of the infraorbital sensory canal. The differences between the cottoid fishes and the generalized percoid fishes are found in the conditions of the lachryopalatine articulation and the second infraorbital bone.

Number of infraorbitals: There are three types in this character among the cottoid fishes, as described above. Type A has five infraorbitals, type B has four infraorbitals, and type C has three infraorbitals. In the most of the generalized percoid fishes, the circumorbitals are composed of one lachrymal and five infraorbitals (Smith and Bailey, 1962; Branson and Moore, 1962; Katayama, 1959; Quast, 1965). It, therefore, is considered that type A is the most primitive in the cottoid fishes. In type B one of the posterior three infraorbitals has been lost, and

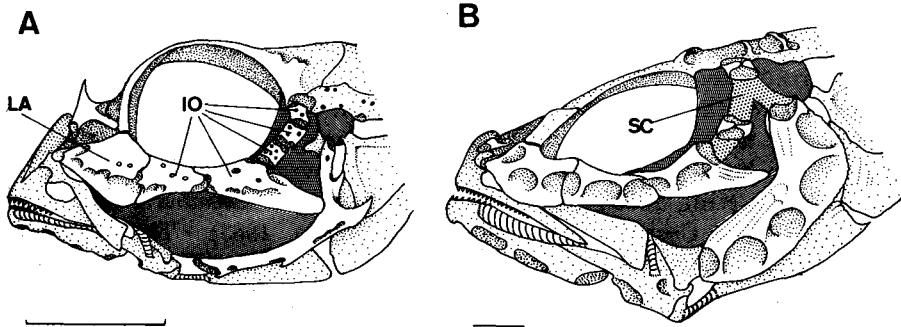

Fig. 5. Circumorbital bones and the sensory canal of 2 cottoid fishes. A, *Jordania zonope*; B, *Ebinamia brephocephala*. IO, infraorbital; LA, lacrimal; SC, infraorbital sensory canal connected with the operculomandibular sensory canal. Scales indicate 2 mm.

in type C there is a successive lose of two of the posterior infraorbitals. Thus, it is regarded that type B is intermediate in the derived condition, and type C is the most derived condition in the cottoid fishes.

On the other hand, this character is examined in the scorpaeniform fishes. The scorpaenid, platycephalid, triglid and hexagrammid fishes examined here are possessed of five infraorbitals which is the same condition as type A in the cottoid fishes. The synanceiid and zaniolepidid fishes are possessed of four infraorbitals which is the same as type B in the cottoid fishes. It has been reported that the cyclopterid fishes have one or two elongated postorbital bones (=the third and/or the fourth infraorbitals), and the liparidid fishes have an elongated postorbital bone (=the third or the fourth infraorbital) (Ueno, 1970). According to Matsubara (1943), the number of the infraorbital is changed as the range from three to five in the scorpaenoid fishes. It is considered that the reduction of the number of the infraorbitals could be occurred in the other groups of the scorpaeniform fishes.

Distributional pattern of the infraorbital sensory canal: There are two conditions in this character among the cottoid fishes. Type A is represented by the most of the cottoid fishes. In this type, the infraorbital sensory canal is not connected with the operculomandibular sensory canal. Type B is represented by all psychrolutid fishes. In this type, the infraorbital sensory canal is connected with the operculomandibular sensory canal. In the generalized percoid fishes, the condition of this character agrees with type A of the cottoid fishes (Branson and Moore, 1962). It, therefore, is considered that type A is the primitive condition, and type B is the derived condition in the cottoid fishes.

On the other hand, it has been recognized that the distributional pattern of the infraorbital sensory canal is sharply defined into two types in the scorpaenoid fishes: one of these types is as same condition as type A of the cottoid fishes, and another is that the infraorbital sensory canal is not connected with the supraorbital canal (Matsubara, 1943). The platycephalid fishes are possessed of the infraorbital sensory canal of type A in the cottoid fishes (Matsubara and Ochiai, 1955). In addition to these observations, type A in the cottoid fishes is also confirmed in the triglid, hexagrammid, zaniolepidid, anoplomatid, cyclopterid and liparidid fishes

examined here, while type B is not observed. Therefore, type B observed in the psychrolutid fishes is regarded as an unique and derived condition among the scorpaeniform fishes.

Condition of the suborbital stay: All cottoid fishes examined here have the suborbital stay which is posterior extension of the second infraorbital. The suborbital stay has been regarded as an important diagnostic character of the order Scorpaeniformes (Gill, 1889; Regan, 1913; Berg, 1940; Matsubara, 1943; Greenwood et al., 1966; Gosline, 1971; Lauder and Liem, 1983). This condition is absent in the generalized percoid fishes whose second infraorbital is not elongated posteriorly but enlarged medially to form the suborbital shelf (Starks, 1901; Katayama, 1959; Smith and Bailey, 1962; Gosline, 1961, 1971). The condition possessing the suborbital stay is regarded as the derived condition of the cottoid fishes in comparison with the condition of the generalized percoid fishes.

Condition of the lachryopalatine articulation: Allis (1909) described that the articular knob which is received in the lateral groove of the palatine is present on the medial surface of the lachrymal in *Cottus* (= *Myoxocephalus*). In the present study, it is confirmed that the articular knob of the lachrymal is present and forms the lachryopalatine articulation in all cottoid fishes examined here (Fig. 6). In the generalized percoid fishes, the lachrymal has an articular facet to the prefrontal, but

does not have an articular knob to the palatine (Katayama, 1959), and it is ligamentously connected with the palatine but does not form the lachryopalatine articulation (Osse, 1969). It, therefore, is considered that the presence of the lachryopalatine articulation is the derived condition shared by all cottoid fishes examined here.

As regarding this character, the scorpaeniform fishes are divided into two groups. It has been reported that the scorpaenoid, platycephalid and triglid fishes have the lachrymal-palatine connection of the percoid type (Allis, 1909; Matsubara, 1943; Matsubara and Ochiai, 1955). This condition is also observed in the anoplopomatid fishes examined here. On the other hand, the hexagrammid, zaniolepidid, cyclopterid and liparidid fishes examined here have the lachryopalatine articulation of the cottoid type.

On the basis of the conditions of the circumorbital bones, the cottoid fishes are classified into five morphotypes summarized in Table 1.

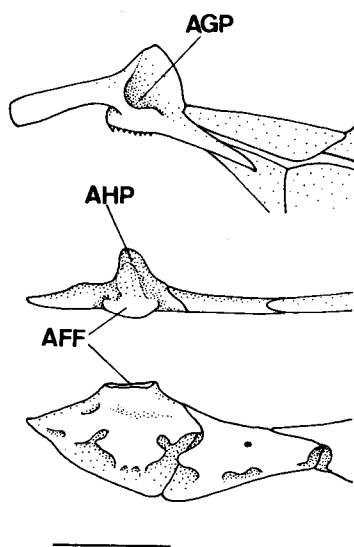

Fig. 6. The lachryopalatine articulation of *Orthonopias triacis*. Above, palatine; Middle, dorsal view of the lachrymal; Below, lateral view of the lachrymal. AFF, articular facet to the prefrontal; AGP, articular groove for the lachryopalatine articulation; AHP, articular head for the lachryopalatine articulation. Scale indicates 2 mm.

Table 1. Comparison of two characters of the circumorbital bones in the cottoid fishes. IO, number of the infraorbitals; ISC, condition of the infraorbital sensory canal. P, primitive condition; D, derived condition (D1 < D2).

Morphotype	Character			Family and genus
	IO	ISC		
I	5	P	separating from opeculomandibula sensory canal (OS)	Ereuniidae; <i>Marukawichthys</i> , <i>Ereunias</i> Rhamphocottidae; <i>Rhamphocottus</i> Hemitripteridae; <i>Hemitripterus</i> Cottidae; <i>Jordania</i> , <i>Scorpaenichthys</i> , <i>Hemilepidotus</i> , <i>Letpocottus</i> , <i>Trachidermus</i> , <i>Cottus</i> , <i>Chitonotus</i> , <i>Artedius</i> , <i>Orthonopias</i> , <i>Icelus</i> , <i>Ricuzenius</i> , <i>Stelgistrum</i> , <i>Stlengis</i> , <i>Icelinus</i> , <i>Oligocottus</i> , <i>Clinocottus</i> , <i>Leiocottus</i> , <i>Synchirus</i> , <i>Gymnocanthus</i> , <i>Alcichthys</i> , <i>Bero</i> , <i>Ocynectes</i> , <i>Furcina</i> , <i>Vellitor</i> , <i>Pseudoblennius</i>
II	4	D1		P Hemitripteridae; <i>Blepsias</i> , <i>Nautichthys</i> Cottidae; <i>Thyriscus</i> , <i>Triglops</i> , <i>Radulinus</i> , <i>Asemichthys</i> , <i>Astrocottus</i> , <i>Artediellus</i> , <i>Artediellichthys</i> , <i>Cottiusculus</i> , <i>Zesticelus</i> , <i>Ascelichthys</i> , <i>Taurocottus</i> , <i>Trichocottus</i> , <i>Myoxocephalus</i> , <i>Microcottus</i> , <i>Porocottus</i> , <i>Argyrocottus</i> , <i>Enophrys</i> , <i>Taurulus</i>
III	3	D2		Agonidae; <i>Agonomalus</i> , <i>Podothecus</i> , <i>Tilesina</i>
IV	4	D1	continueing to OS	D Psychrolutidae; <i>Dasycottus</i> , <i>Eurymen</i> , <i>Ebinania</i> , <i>Malcocottus</i> , <i>Neophrynichthys</i> , <i>Psychrolutes</i>
V	3	D2		Psychrolutidae; <i>Cottunculus</i>

2. CRANIUM (Figs. 7-13 ; Table 2)

Description. The cranium is composed of five unpaired elements ; the prevomer, the ethmoid, the parasphenoid, the supraoccipital, and the basioccipital ; and eleven paired elements ; the prefrontal, the frontal, the pterosphenoid, the sphenotic, the prootic, the parietal, the pterotic, the epiotic, the intercalar, the exoccipital and the nasal. In the cottoid fishes examined here, the basisphenoid is absent.

Prevomer (PV) : The prevomer is triangular or quadrangular in general form. This bone lies in the anterolateral and ventral surfaces of the ethmoid cartilage (EC) and forms the anteriormost region of the cranium. The anterior portion of this bone is distinctly expanded and bears villiform teeth ventrally in the most of the cottoid fishes except for the fishes of the genera *Gymnocanthus*, *Malacocottus*, *Neophrynichthys* and *Psychrolutes*. The prevomer tapers posteriorly and is firmly connected with the parasphenoid. Posterolaterally this bone is attached or closely approached to the prefrontal. A strong ligament coming from the anterior tip of the entopterygoid inserts to the anterolateral corner of the prevomer.

Ethmoid (ET) : The ethmoid lies on the dorsal midline of the ethmoid cartilage. This bone is united to the frontals posteriorly and attached or closely approached to the prefrontal laterally, and ligamentously connected with the nasals dorsolaterally. The ethmoid forms a keel on the dorsal midline where this bone articulates to the premaxillary by the interposition of the rostral cartilage. Dorsolaterally the ethmoid has a pair of processes from which a strong ligament extends to the maxillary head.

Prefrontal (PF) : The prefrontal is situated on each side of the ethmoid. This bone is possessed of a developed lateral wing which forms the anterior border of the orbit. This bone is connected with the frontal posterodorsally, and attached or closely approached to the ethmoid dorsally, and to the prevomer ventrally. This bone is possessed of an articular facet for the lachryocranial articulation on the ventrolateral corner of the lateral wing. On the inside from the facet of the lachryocranial articulation, a small articular head is present in the fishes of the genera *Hemitripterus*, *Blepsias*, *Nautichthys*, *Jordania*, *Hemilepidotus*, *Scorpaenichthys*, *Cottus*, *Trachidermus* and *Leptocottus*. In these fishes, this articular head is joined to the small facet of the palatine and forms the palatocranial articulation (Fig. 11, A). In the other cottoid fishes, the articular head of the prefrontal is reduced or absent, and the palatocranial articulation is obscure.

Frontal (F) : The frontal is the largest bone placed on the dorsal roof of the cranium between the ethmoid and the parietal. This bone meets its antimere on the dorsal midline and forms the interorbital space. The frontal is connected with the ethmoid and the prefrontal anteriorly, with the parietal, the supraoccipital and the pterotic posteriorly, and with the pterosphenoid and the sphenotic posteroventrally. Anteroventrally, the frontal is attached to the ethmoid cartilage which forms a median septum in the anterior part of the orbit. On the dorsal surface, the frontal is possessed of a series of the tubular structure which is passed by the supraorbital sensory canal.

Parietal (PA) : The parietal forms the posterodorsal roof of the cranium. On

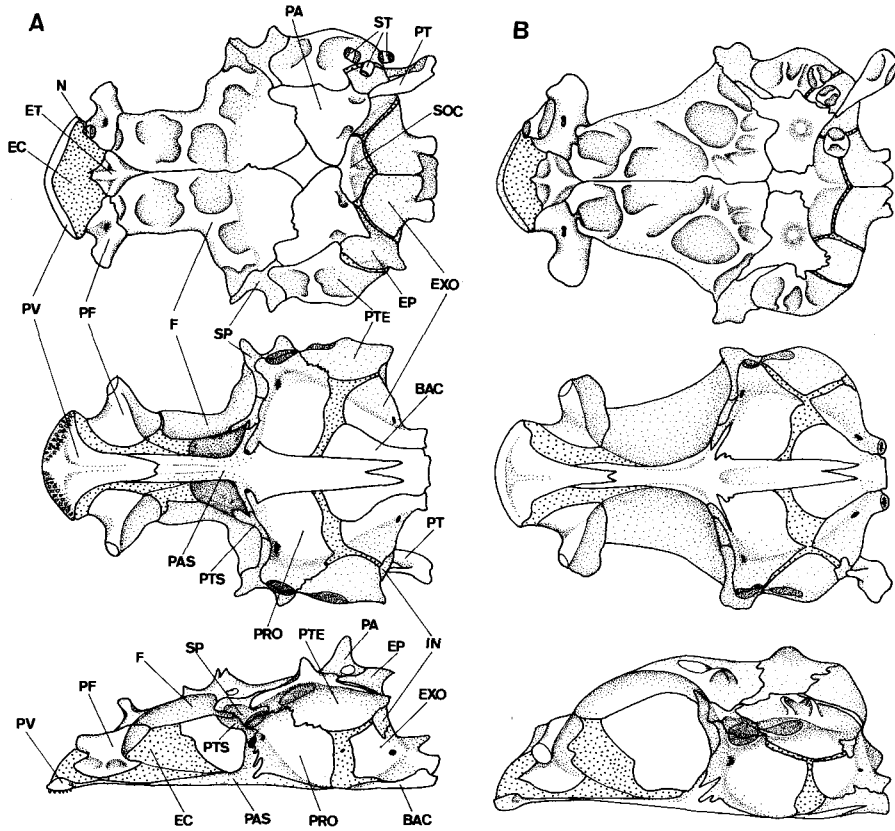

Fig. 7. Dorsal (above), ventral (middle) and lateral (below) aspects of the cranium. A, *Dasycottus setiger*; B, *Malacocottus gibber*. BAC, basioccipital; EC, ethmoid cartilage; EP, epiotic; ET, ethmoid; EXO, exoccipital; F, frontal; IN, intercalar; N, nasal; PA, parietal; PAS, parasphenoid; PF, prefrontal; PRO, prootic; PT, posttemporal; PTE, pterotic; PTS, pterosphenoid; PV, prevomer; SOC, supraoccipital; SP, sphenotic; ST, supratemporal.

the dorsal surface, this bone overlaps on the supraoccipital and is attached or closely approached to the antimere on the dorsal midline. This bone is connected with the frontal anteriorly, with the pterotic laterally, and with the epiotic and the supraoccipital posteriorly. On the posterior margin, this bone forms a tubular structure for the supratemporal commissure of the sensory canal in the most of the cottoid fishes examined. In the fishes of the genera *Ebinania*, *Malacocottus*, *Neophrynichthys* and *Psychrolutes*, the tubular structure is free from the parietal, and is present as a tubular bone on this bone.

Sphenotic (SP): The sphenotic forms the posterodorsal wall of the orbit, and is bordered by the frontal, the pterosphenoid, the prootic and the pterotic. On the dorsal surface, this bone forms a groove where the fifth infraorbital is attached. Ventrolaterally, this bone is connected with the prootic and forms a rounded socket

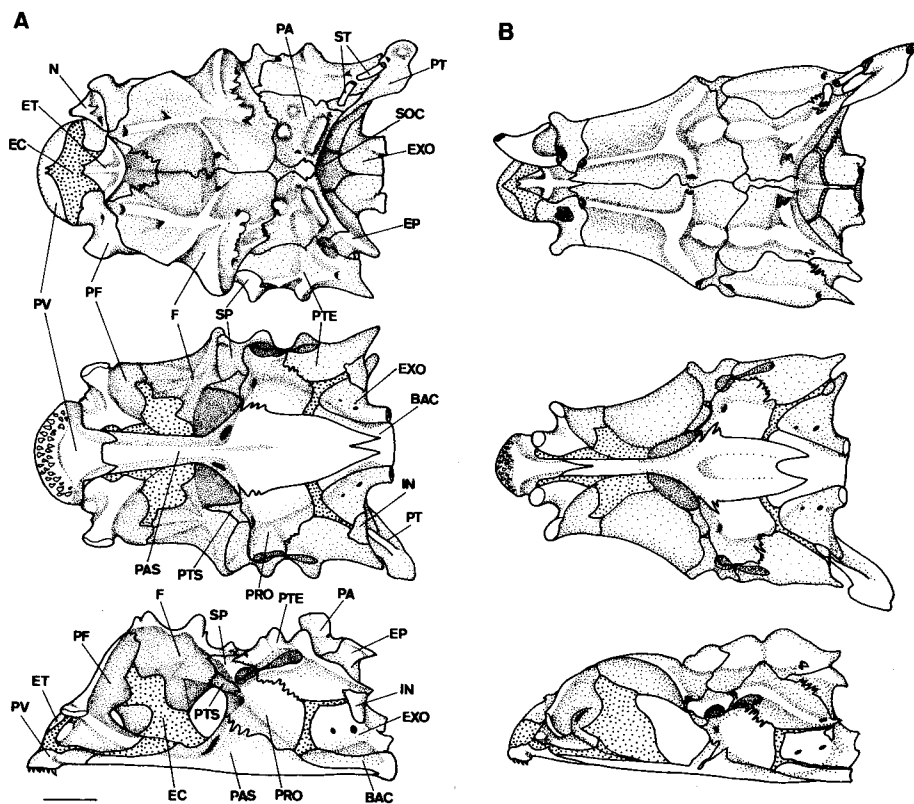

Fig. 8. Dorsal (above), ventral (middle) and lateral (below) aspects of the cranium. A, *Hemitripteris villosus*; B, *Blepsias cirrhosus*. For abbreviation, see Fig. 7. Scales indicate 10 mm.

which receives the anterior articular head of the hyomandibular.

Pterosphenoid (PTS): The pterosphenoid forms the corner of the posterodorsal wall of the orbit. This bone is connected with the frontal dorsally, with the sphenotic posterodorsally, and with the prootic posteroventrally. In the most of the cottoid fishes examined, the pterosphenoid is attaches to the lateral wing of the parasphenoid ventrally, while it is separated from the parasphenoid by the intervention of the prootic in the fishes of the genera *Hemitripteris*, and *Blepsias*, and families Ereuniidae and Psychrolutidae.

Prootic (PRO): The prootic is a very large paired bone and forms the anterolateral side of the otic region. This bone is connected with the pterosphenoid, the parasphenoid, the sphenotic, the pterotic and the basioccipital. This bone is attached or closely situated to the exoccipital posteriorly. The prootic is possessed of the trigeminofacialis chamber anterolaterally. Among the cottoid fishes examined here, three conditions of this chamber are found. Type A includes *Rhamphocottus richardsoni* in which the trigeminofacialis chamber is almost covered with a wide vertical bridge (Fig. 12, C). Type B includes all cottoid fishes and a

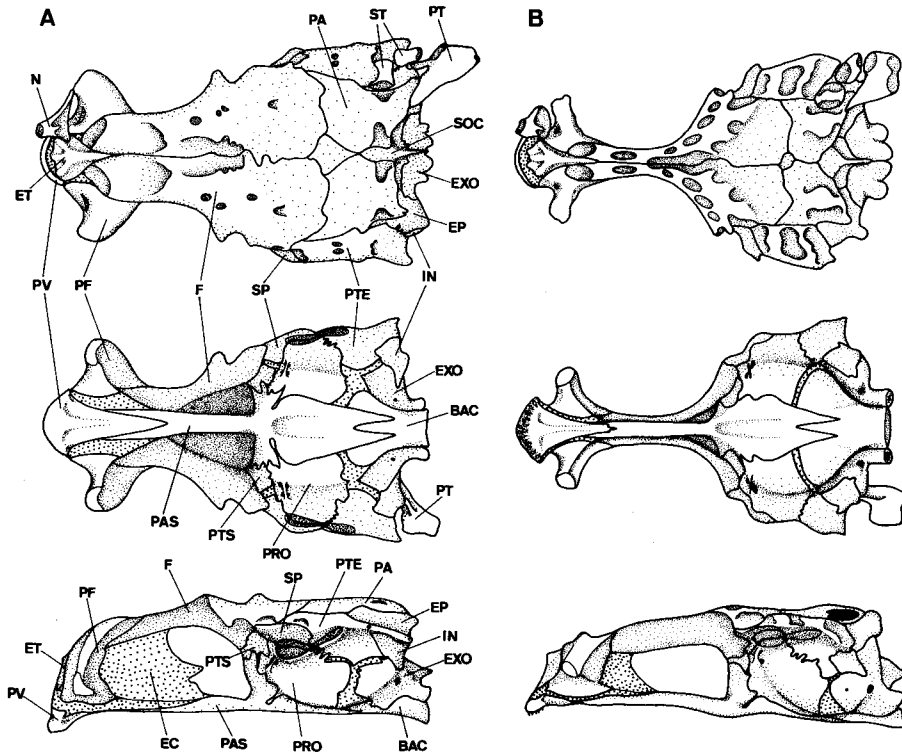

Fig. 9. Dorsal (above), ventral (middle) and lateral (below) aspects of the cranium. A, *Gymnocanthus herzensteini*; B, *Artediellus dydymovi*. For abbreviation, see Fig. 7. Scales indicate 10 mm.

hemitripterid genus *Nautichthys* and two agonid genera *Tilesina* and *Podothecus*. In these fishes, there are two foramina in this chamber from which the trigeminofacialis nerves are transmitted, and a thin vertical bridge crossing over the chamber (Fig. 12, A, B). Type C includes an agonid genus *Agonomalus* and two hemitripterid genera *Hemitripterus*, and *Blepsias* and the psychrolutid fishes. In these fishes, the vertical bridge is absent. In the fishes of the families Ereuniidae and Psychrolutidae and the hemitripterid genera *Hemitripterus*, and *Blepsias*, the prootic forms the posterior margin of the orbit. In the other cottoid fishes examined, the prootic does not form the posterior margin of the orbit, because the pterosphenoid and the parasphenoid are jointed each other before the anterior margin of the prootic. Between the prootic and the pterosphenoid-parasphenoid junction, there is a large gap where the oculomotor nerve transmitted from a small foramen near the trigeminofacialis chamber is reentered.

Parasphenoid (PAS): The parasphenoid forms the greater part of the cranial base. This bone is connected with the prevomer anteriorly, with the prootic posterolaterally, and with the basioccipital posteriorly. This bone possesses a lateral wing on each side. In the most of the cottoid fishes examined, the lateral

wing attaches to the pterospheoid dorsally, while it is separated from the latter in the fishes of the genera *Hemitripteris*, and *Blepsias*, and the families Ereundiidae and Psychrolutidae. This lateral wing of the parasphenoid extends to the frontal in the fishes of the genera *Artediellus*, *Ascelichthys*, *Cottus*, *Leptocottus* and *Taurulus*. In *Alcichthys alcicornis*, *Cottus nozawae* and *Porocottus allisi*, the lateral wing is attached or closely approached to the frontal dorsally.

Pterotic (PTE): The pterotic forms the posterolateral corner of the cranium. This bone is bordered by the sphenotic, the parietal, the prootic, the exoccipital, the intercalar and the epiotic. The pterotic has a rounded socket which receives the posterior articular head of the hyomandibular. On the posterolateral corner, this bone possesses a process directing backward where the levator pectoralis is originated. On the dorsal surface of this bone, there are two bony arches which are passed by the cephalic sensory canal. The posterior one is free from the pterotic and forms a tubular bone in the fishes of the family Psychrolutidae. The anterior bony arch is free from the pterotic in *Psychrolutes phrictus*.

Epiotic (EP): The epiotic is the paired bone forming the posterolateral corner of the cranium. This bone is bordered by the parietal, the pterotic, the intercalar, the exoccipital and the supraoccipital. On the posterolateral face, the epiotic is firmly attached to the anterodorsal process of the posttemporal. There is a shallow supratemporal fossa on the region between the epiotic and the pterotic.

Intercalar (IN): The intercalar is a small paired bone and situated between the pterotic and the exoccipital. This bone is separated from the prootic. This bone is ligamentously connected with the anteroventral process of the posttemporal.

Supraoccipital (SOC): The supraoccipital is situated on the dorsal midline of the posterior region of the cranium. This bone is connected with the frontal anteriorly, with the parietal and the epiotic laterally, and with the exoccipital posteriorly. In the cottoid fishes examined, the supraoccipital crest is not developed.

Exoccipital (EXO): The exoccipital forms posterolateral face of the otolith chamber. This bone is connected with the pterotic, the intercalar, and the epiotic dorsally, and with the basioccipital ventrally. This bone is attached or closely approached to the prootic anteriorly. Posteromedianly this bone meets with its antimere and forms the dorsolateral wall of the foramen magnum. The exoccipital possesses a developed condyle posteroventrally where it articulates with the lateral articular head of the first centrum. The vagus foramen opens on this bone.

Basioccipital (BAC): The basioccipital is placed on the ventral midline of the posterior part of the cranium. This bone is connected with the parasphenoid anteriorly, and with the exoccipital posterolaterally, and articulated with the first centrum posteriorly. In the cottoid fishes examined except for the fishes of the cottoid genera *Pseudoblennius* and *Vellitor*, and the families Hemitripteridae and Agonidae, the Baudelot's ligament is originated from the posterolateral tip of the basioccipital.

Supratemporal (ST): The supratemporal is tubular bone situated on the temporal region of the cranium. The most of the cottoid fishes are possessed of two supratemporals (the anterior and the posterior). The sensory canal coming from the posttemporal passes through the posterior element and branched into two ways; one

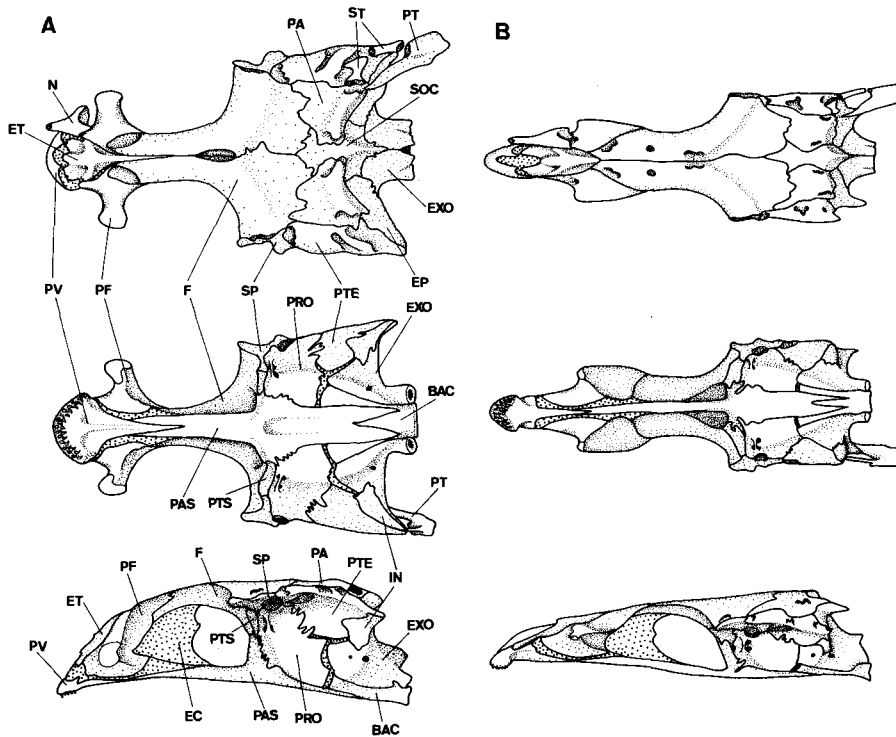

Fig. 10. Dorsal (above), ventral (middle) and lateral (below) aspects of the cranium. A, *Alcichthys alcicornis*, B, *Vellitor centropomus*. For abbreviation, see Fig. 7. Scales indicate 10 mm.

of them extends forward to reach the tubular structure of the pterotic, and the another one extends medianly and passes through the anterior element of the supratermporal to reach the tubular structure of the parietal. In the psychrolutid genera *Cottunculus*, *Malacocottus*, *Neophrynichthys*, and *Psychrolutes*, the posterior elements of the supratermporal are absent. In the fishes of the families Rhamphocottidae and Agonidae examined here and *Hemitripterus bolini* the supratermporal is present as a single bone having three openings. In these fishes, the sensory canal is branched in this bone.

Discussion. The cranium of the cottoid fishes has been studied and discussed by many authors (Girard, 1852; Gill, 1889; Allis, 1909; Regan, 1913; Gutberlet, 1915; Johnson, 1918; Matsubara, 1936; Taranetz, 1941; Taliev, 1955; Watanabe, 1958; Quast, 1965; Ilyina, 1978; Yabe, 1981; Nelson, 1982). In these studies, two characters, small intercalar and the absence of the basisphenoid, have been regarded as the peculiarity of the superfamily Cottoidea. In addition to these characters, the conditions of the pterosphenoid-parasphenoid junction, the trigeminofacialis chamber and the myodome have been regarded as important evidence of the consideration of the phylogeny of the cottoid fishes (Taranetz, 1941; Quast, 1965; Yabe, 1981). In the present study, these characters are reexamined

and other characters observed here are discussed on the basis of the present character analysis. Among the cottoid fishes examined here, distinct differences are found in the presence or absence of teeth on the prevomer, the condition of the palatocranial articulation, the condition of pterosphenoid-parasphenoid junction, the condition of the trigeminofacialis chamber, the presence or absence of the basioccipital-parasphenoid fossa, the condition of the supratemporal commissure, and the condition of the Baudelot's ligament. On the other hand, conditions of the intercalar, the posttemporal fossa and the basisphenoid are uniform in the cottoid fishes, but they are changed in the scorpaeniform fishes.

Teeth on prevomer: This character has been regarded as one of the important characters for the identification of the cottoid fishes. It is considered that this character is important for the consideration of the cottoid phylogeny because the condition of this character is almost stable within species. Most of the cottoid fishes examined here are possessed of teeth on the prevomer, while the fishes of the cottid genus *Gymnocanthus* and the psychrolutid genera *Malacocottus*, *Neophrynichthys* and *Psychrolutes*, and the agonid genera *Agonomalus* and *Podothecus* are not possessed of teeth on the prevomer. In the generalized percoid fishes, teeth are present on the prevomer (Jordan and Evermann, 1896; Katayama, 1959). Therefore it is considered that the condition having teeth on the prevomer is the primitive in the cottoid fishes.

On the other hand, this character is changed in the scorpaeniform fishes. In the scorpaenid, triglid, platycephalid, hexagrammid, anoplomatid and zaniolepidid fishes, teeth are present on the prevomer, while they are absent in the cyclopterid and liparidid fishes.

Condition of the palatocranial articulation: The importance of this character for the phylogenetic consideration of the scorpaeniform fishes has been suggested by Quast (1965), but he did not discuss further. Among the cottoid fishes examined here, two conditions are found in this character. Type A includes the fishes of hemitripterid genera *Hemitripterus*, *Blepsias* and *Nautichthys* and the cottid genera *Jordania*, *Hemilepidotus*, *Scorpaenichthys*, *Cottus*, *Trachidermus* and *Leptocottus*. In these fishes, a small articular head is present on the ventral surface of the prefrontal. It is joined to a small facet of the palatine and forms the palatocranial articulation (Fig. 11, A). Type B includes other cottoid fishes examined in which the palatocranial articulation is obscure (Fig. 11, B). This character has been discussed in the serranid and the percichthyid fishes by Gosline (1966). According to his observation, the serranid genera *Epinephelus*, *Diplectrum* and *Pteranthias* have two distinct articular points between the prefrontal and the palatine, while the percichthyid genera *Percichthys*, *Percilia* and *Roccus* have one articular point there. Thus it is considered that one or two points of the palatocranial articulation are present in these fishes. The palatocranial articulation has been observed in other generalized percoid fishes (Gregory, 1933; Katayama, 1959; Liem, 1970; Bertone, 1977). Therefore, it is considered that the condition having the palatocranial articulation is the primitive condition among the cottoid fishes.

On the other hand, the derived condition in which the palatocranial articulation is absent or obscure is observed in the cyclopterid and liparidid fishes, while it is not in the other scorpaeniform fishes.

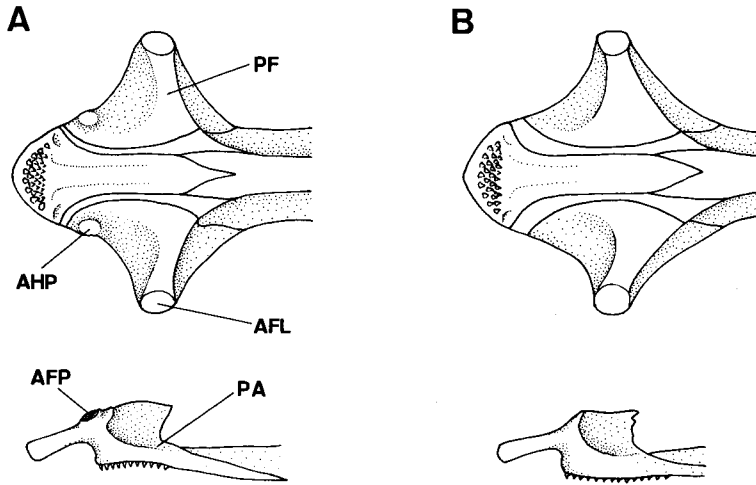

Fig. 11. Two types of the palatocranial articulation in the cottoid fishes. A, the articulation is present (type A in text); B, the articulation is absent (type B in text). AFP, articular facet on palatine; AHP, articular head on the prefrontal; AFL, articular facet for lachryocranial articulation; PA, palatine; PF, prefrontal.

Condition of the pterosphenoid-parasphenoid junction: The presence of the pterosphenoid-parasphenoid junction has been regarded as the one of the osteological diagnoses of the Taranetz's family Cottidae (Taranetz, 1941). On the other hand, this condition has been considered as an important evidence of the hexagrammid-zaniolepid-cottid evolution line by Quast (1965). Among the cottoid fishes examined here, two conditions are found in this character. The first type, type A, includes the fishes of the families Ereuniidae, Psychrolutidae and the hemitripterid genera *Hemitripterus*, and *Blepsias*. In these fishes, the pterosphenoid is separated from the parasphenoid by the intervention of the prootic (Fig. 12, A and D). The second type, type B, includes the families Cottidae, Agonidae, Rhamphocottidae and hemitripterid genus *Nautichthys*. In these fishes the pterosphenoid is attached to the parasphenoid (Fig. 12, B and C). In the some of species included in this type, the lateral wing of the parasphenoid extends to the frontal. But this condition is changed within a species. Thus this condition is regarded as same character state as type B. Among these two types, type A has been observed in the generalized percoid fishes, while type B has not been in those fishes (Gregory, 1933; Katayama, 1959; Quast, 1965; Gosline, 1966, Tominaga, 1968; Bortone, 1977). Therefore, it is considered that type B is the derived condition in the cottoid fishes.

As regarding this character, two conditions mentioned above are also observed in the other scorpaeniform fishes. The derived condition of this character is observed in the hexagrammid, zaniolepidid, cyclopterid and liparidid fishes and an anoplopomatid genus *Anoplopoma* (Quast, 1965). In the other scorpaeniform fishes, the pterosphenoid is separated from the parasphenoid. The presence of the pterosphenoid-parasphenoid junction has been regarded as one of the diagnoses of the Taranetz's family Cottidae (Taranetz, 1941). As a result of the present study,

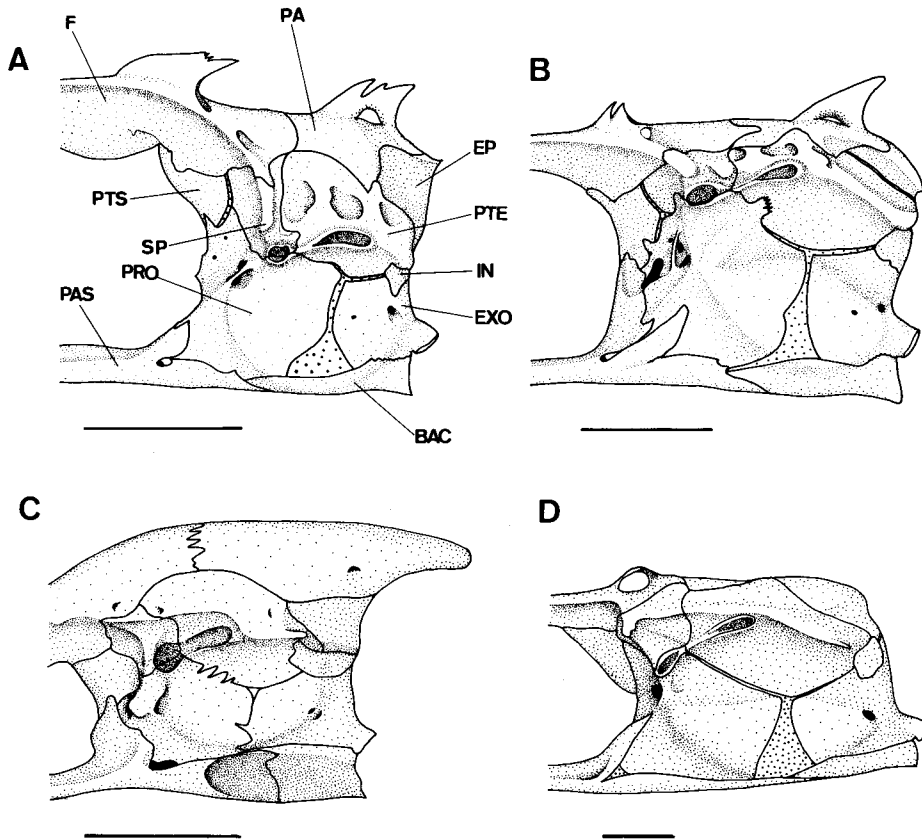

Fig. 12. Lateral aspects of the occipital region in; A, *Ereunias grillator*; B, *Icelus spiniger*; C, *Rhamphocottus richardsoni*; D, *Ebinania brephocephala*. For abbreviation, see Fig. 7. Scales indicate 10 mm.

it is considered that this condition is regarded as one of the synapomorphies of his family Cottidae, but it is not unique and derived condition of this family, because this condition is observed in the rhamphocottid and agonid fishes which do not belong to his family Cottidae. On the other hand, the presence of the pterosphenoid-parasphenoid junction has been regarded as the important evidence of the hexagrammid-zaniolepidid-cottid evolutionary line (Quast, 1965). But the condition that the pterosphenoid is separated from the parasphenoid is observed in some of the cottoid fishes. Therefore, the Quast's assumption can no be recognized, when it is judged on the basis of this character.

Condition of the trigeminofacialis chamber: The condition of this region has been discussed in the lower teleostean fishes and the fossils of the acanthopterygian fishes, and regarded as an important character to consider the evolution of the teleostean fishes (Goodrich, 1930; Patterson, 1964). On the other hand, this character has been scarcely examined in the higher acanthopterygians. The condition of this character has been described in some scorpaeniform fishes by Allis (1909).

Taranetz (1941) has regarded this character as one of the osteological diagnoses of some of his cottoid families. In the present study, three conditions are found in this character among the cottoid fishes examined here. The first condition, type A, includes a monotypical family Rhamphocottidae in which the trigeminofacialis chamber is almost covered with a wide vertical bridge (Fig. 12; C). The second type, type B, includes all cottid fishes, a hemitripterid genus *Nautichthys* and two agonid genus *Tilesina* and *Podothecus*. In these fishes, there are two foramen in the chamber from which the trigeminofacialis nerves are transmitted, and a thin vertical bridge crosses over the chamber (Fig. 12, A and B). The third condition, type C, includes the psychrolutid fishes, an agonid genus *Agonomalus* and two hemitripterid genera *Hemitripterus*, and *Blepsias*. In these fishes, the trigeminofacialis nerves are transmitted from one or two foramen in the trigeminofacialis chamber where the vertical bridge is absent (Fig. 12, D). Among these types, type A has been observed in the generalized percoid fishes (Gregory, 1933; Katayama, 1959; Patterson, 1964; Bortone, 1977). Therefore it is considered that type A is the most primitive condition, and type B is intermediate condition and type C is the most derived condition.

On the other hand, the most of the scorpaeniform fishes examined here are possessed of the trigeminofacialis chamber of type A, and the cyclopterid and liparid fishes are possessed of the condition of type D.

Basioccipital-parasphenoid fossa: Among the cottoid fishes examined, the basioccipital fossa is found in *Rhamphocottus richardsoni* (Fig. 12, C). In this species, a pair of fossae is present on the ventral surface of the basioccipital and the parasphenoid. This fossa is very large and forms a ventral keel on the ventral midline of the basioccipital region. The extrinsic muscle of the swimbladder originates from this fossa. This condition is not observed in the other cottoid and scorpaeniform fishes examined. In the generalized percoid fishes, the condition in *Rhamphocottus* has not been observed (Gregory, 1933; Katayama, 1959; Gosline, 1966; Tomonaga, 1968). A spherical hollow placed on the each side of the basioccipital has been reported in *Doderleinia* and *Synagrops* and it was named as the basioccipital fossa (Katayama, 1952 and 1959). It is considered that the basioccipital fossa of the percoid fishes is not homologous to the basioccipital-parasphenoid fossa of *Rhamphocottus* because the fossa is inserted by the anterior branch of the swimbladder in the former and by the extrinsic muscle in the latter, and because the ventral keel in the latter has not been observed in the former. It, therefore, is considered that the basioccipital-parasphenoid fossa in *Rhamphocottus* is the unique and derived condition among the cottoid fishes.

Baudelot's ligament: The condition of the Baudelot's ligament inserting to the basioccipital has been regarded as one of the diagnostic characters defining the acanthopterygian fishes (Greenwood et al., 1966). But it is clarified that this condition is changed in the cottoid fishes examined here. In the most of the cottoid fishes, the ligament inserts to the posteroventral tip of the basioccipital, while it inserts to the first vertebra in the fishes of the families Hemitripteridae and Agonidae, and the cottid genera *Pseudoblennius* and *Vellitor*. In the generalized percoid fishes, it has been reported that this ligament inserts to the posterior tips of the basioccipital (Greenwood et al., 1966; Gosline, 1966; Osse, 1969). Therefore, it

is considered that the condition that the Baudelot's ligament inserts to the basioccipital is the primitive condition among the cottoid fishes.

On the other hand, the condition that the Baudelot's ligament inserts to the first centrum is not observed among the scorpaeniform fishes examined. According to Greenwood et al. (1966), this condition is present in a scorpaenid genus.

Supratemporal commissure: In the cottoid fishes examined, the supratemporal commissure is well developed and is supported by some tubular bones or bony arches of the supratemporal, the parietal and the pterotic. The condition of this supporting structure is remarkably changed in the cottoid fishes. On the basis of the condition of this character, the cottoid fishes are classified into six morphotypes. Type A includes *Hemitripterus bolini* and the rhamphocottid and agonid fishes examined here. In these fishes, the supratemporal is a single bone having three openings. Two tubular structures are present on the pterotic and one is on the parietal. These tubular structures are deeply buried in the basal bones in this type. The sensory canal coming from the posttemporal inserts to the supratemporal and then it is branched in this bone. One of those branches is transmitted from the anterior opening of the supratemporal and extends to bony arch on the pterotic. Another branch is transmitted from the median opening of the supratemporal and extends to the bony arch on the parietal (Fig. 13, A). Type B includes all cottoid fishes examined, ereuniid and three hemitriptid genera *Blepsias*, *Nautichthys* and *Hemitripterus*. In these fishes, the supratemporal is composed of two tubular bones (anterior and posterior) (Fig. 13, B). There are two bony arches on the pterotic, one on the parietal. The sensory canal coming from the posttemporal penetrates the posterior supratemporal and branched into two ways. One of them extends forward and reaches the bony arch on the pterotic. The other branch extends medianly, and penetrates the anterior supratemporal and bony arch on the parietal to form the supratemporal commissure. Type C includes two psychrolutid genera *Dasycottus* and *Eurymen*. In this type, the supratemporal is composed of two tubular bone (anterior and posterior). The posterior bony arch on the pterotic becomes to form a tubular bone. The sensory canal is branched between the posterior supratemporal and the tubular bone on the pterotic (Fig. 13, C). In type D including a psychrolutid fishes *Cottunculus*, the anterior supratemporal and the tubular bone on the pterotic are present, but the posterior supratemporal is absent. The sensory canal is branched between the posttemporal and the tubular bone on the pterotic (Fig. 13, D). Type E includes three psychrolutid genera *Ebinania*, *Malacocottus* and *Neophrynichthys*. This type is resembles the type D, but the bony arch on the parietal is free from the basal bone, and forms a tubular bone (Fig. 13, E). Type F includes a psychrolutid genus *Psychrolutes*. In this type the anterior bony arch on the pterotic is free from the basal bone and forms a tubular bone (Fig. 13, F).

It has been reported that the supratemporal commissure is incomplete in the generalized percoid fishes (Branson and Moore, 1962). In these fishes, the supporting structure of the supratemporal region is different from that in the cottoid fishes. According to Branson and Moore (1962), there are two tubular bones in this region in the generalized percoid fishes. One of them is the supratemporal which is T-or Y-shaped with three openings. The another is the medial extrascapular bone which lies median to the supratemporal. The sensory canal coming from the posttemporal

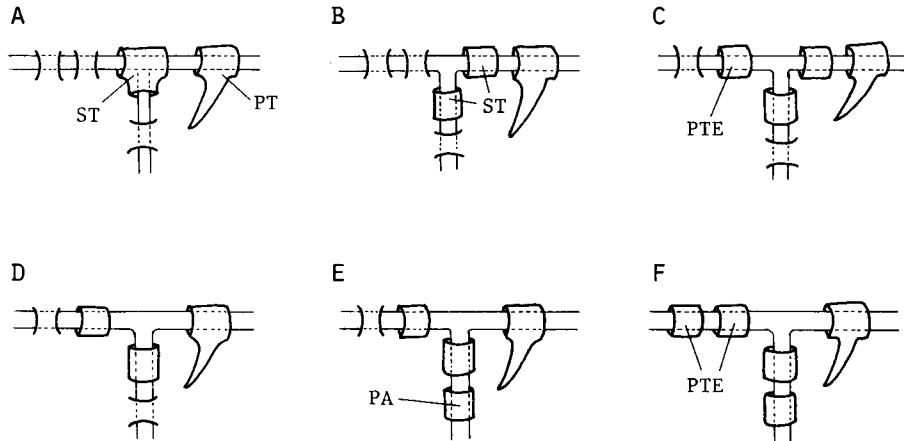

Fig. 13. Six types of the supratemporal commissure of the sensory canal in the cottoid fishes. PA, tubular bone on the parietal; PT, posttemporal; PTE, tabular bone on the pterotic; ST, supratemporal. For explanation, see text.

inserts to the supratemporal and is branched in this bone. One of these branches extends forward and reaches to the pterotic. Another one extends medianly and passes through the medial extrascapular bone to form a round pore at the median end. There are some neuromasts between ends of the median branches of both sides. It has been said that the medial extrascapula bone is homologous to the tubular structure on the parietal (Halington, 1955; Branson and Moore, 1962). But it is hardly considered that medial extrascapula bone of the percoid fishes is the same condition as the tubular bone on the parietal observed in some cottoid fishes, because the extrascapular bone is situated on the lateral inserting head of the epaxialis, while the tubular bone of the cottoid fishes is situated on the parietal bone. Therefore, it is considered that these two conditions are different conditions.

On the basis of the assumption that the condition of the generalized percoid fishes is the ancestral condition of the cottoid type, it is considered that the type A of the cottoid fishes is the most primitive condition in the cottoid fishes, because the supratemporal has three openings as same as that of the percoid fishes. From this primitive condition, it is considered that each type of the cottoid fishes is occurred successively. Type B is occurred from type A by the separation of the supratemporal. Type C is occurred from type B by separation of the tubular bone on the pterotic. Type D is occurred from type C by the loss of the posterior supratemporal. From type D, type E is occurred by the separation of the tubular bone on the parietal. And type F is occurred from type E by the separation of the anterior tubular bone on the pterotic.

Among the scorpaeniform fishes examined here, the type A is observed in the scorpaenid, triglid, and platycephalid fishes, and the type B is observed in the hexagrammid, zaniolepidid and anoplopomatid fishes in which the supratemporal commissure is moved to anterior margin of the parietal in relation to the anterior extension of the epaxialis.

Basisphenoid: Regan (1913) considered that the absence of the basisphenoid

Table 2. Comparison of seven characters of the cranium in the cottoid fishes. VT, vomerine teeth; trigeminofacialis chamber; BPF, basioccipital-parasphenoid fossa; BL, Baudelot's ligament; (D1 < D2 < D3.....).

Morphotype	Character									
	VT		PAC		PPJ		TFC		BPF	
I	present	P	absent	D	present	D	broad vertical bridge	P	present	D
II					absent	P	narrow vertical bridge	D1		
III					present	D				
IV	absent	D	absent	D	absent	P	no vertical bridge	D2		
V										
VI	present	P	absent	D	present	D	narrow vertical bridge	D1	absent	P
VII										
VIII										
IX										
X	absent	D	absent	D	absent	P	no vertical bridge	D2		
XI										
XII	present	P	absent	D	absent	P	no vertical bridge	D2		
XIII										
XIV										
XV	absent	D	absent	D	absent	P	no vertical bridge	D2		
XVI										
XVII										

was one of the osteological diagnoses of his Cottiformes (cottoid, cyclopterid and liparidid fishes in the present study). Since then, this character has been regarded as the evidence of the monophyly of the cottoid fishes (Taranez, 1941; Matsubara, 1943; Quast, 1965). Matsubara (1943) considered that the cottids have occurred

PAC, palatocranial articulation; PPJ, pterosphenoid-parasphenoid junction; TFC, STC, supratemporal commissure of sensory canal. P, primitive condition; D, derived condition

BL		STC		Family and genus
attaching to basioccipital	P	Type A	P	Rhamphocottidae; <i>Rhamphocottus</i>
		Type B	D1	Ereuniidae; <i>Marukawichthys</i> , <i>Ereunias</i>
attaching to the first vertebra	D	Type A	P	Agonidae; <i>Tilesina</i>
				Agonidae; <i>Podothecus</i>
				Agonidae; <i>Agonomalus</i>
				Hemitripteridae; <i>Hemitripterus bolini</i>
attaching to basioccipital	P	Type B	D1	Hemitripteridae; <i>Hemitripterus villosus</i> , <i>Blepsias</i>
				Hemitripteridae; <i>Nautichthys</i>
				Cottidae; <i>Jordania</i> , <i>Scorpaenichthys</i> , <i>Hemilepidotus</i> , <i>Leptocottus</i> , <i>Trachidermus</i> , <i>Cottus</i>
				Cottidae; <i>Artedius</i> , <i>Chitonotus</i> , <i>Orthonopias</i> , <i>Triglops</i> , <i>Radulinus</i> , <i>Asemichthys</i> , <i>Astrocottus</i> , <i>Icelus</i> , <i>Ricuzenius</i> , <i>Stelgistrum</i> , <i>Thryscus</i> , <i>Stlengis</i> , <i>Icelinus</i> , <i>Oligocottus</i> , <i>Clinocottus</i> , <i>Leiocottus</i> , <i>Synchirus</i> , <i>Ascelichthys</i> , <i>Artediellus</i> , <i>Cottiusculus</i> , <i>Artediellichthys</i> , <i>Zesticelus</i> , <i>Taurocottus</i> , <i>Trichocottus</i> , <i>Myoxocephalus</i> , <i>Microcottus</i> , <i>Porocottus</i> , <i>Argyrocottus</i> , <i>Enophrys</i> , <i>Taururlus</i> , <i>Alcichthys</i> , <i>Bero</i> , <i>Ocynectes</i> , <i>Furcina</i>
				Cottidae; <i>Gymnocanthus</i>
attaching to the first vertebra	D			Cottidae; <i>Pseudoblennius</i> , <i>Vellitor</i>
attaching to basioccipital	P	Type C	D2	Psychrolutidae; <i>Dasycottus</i> , <i>Eurymen</i>
		Type E	D4	Psychrolutidae; <i>Ebinania</i>
		Type D	D3	Psychrolutidae; <i>Cottunculus</i>
		Type E	D4	Psychrolutidae; <i>Malacocottus</i> , <i>Neophrynichthys</i>
		Type F	D5	Psychrolutidae; <i>Psychrolutes</i>

from a scorpaenid not very unlike the *Setarches* on the basis of the condition of the absence of the basisphenoid. In the present study, it is reconfirmed that all cottoid fishes examined does not have the basisphenoid. On the other hand, the basisphenoid has been reported in the generalized percoid fishes (Gregory, 1933;

Katayama, 1959 ; Gosline, 1961 ; Quast, 1965 ; Tominaga, 1968, etc.). It, therefore, is considered the absence of the basisphenoid is the derived condition for the cottoid fishes.

Among the scorpaeniform fishes examined, the basisphenoid is absent in a scorpaenid species *Setarches* and the cyclopteroid fishes. Other scorpeniform fishes have the basisphenoid. Ueno (1970) described this bone in the cyclopteroid fishes. But it is considered that the anterior margin of the prootic is misidentified with the basisphenoid.

Intercalar: Small intercalar which does not extend to the prootic has been regarded as the osteological diagnosis of the cottoid fishes (Regan, 1913 ; Taranetz, 1941 ; Quast, 1965). Matsubara (1936) has reported that the cottoid members *Marukawichthys*, *Ereunias* and *Icelus* have a large intercalar (the opisthotic in his description). Berg (1940) established the family Icelidae for these three genera on the basis of the osteological description made by Matsubara (1936). But Yabe (1981) reexamined these three genera and clarified that these genera are possessed of a small intercalar as same as that in other cottoid fishes. In this study, it is reconfirmed that all cottoid fishes examined here are possessed of a small intercalar. The condition that the large intercalar extends to the prootic has been reported in the generalized percoid fishes (Gregory, 1933 ; Katayama, 1959 ; Quast, 1965, Tominaga, 1968). It, therefore, is considered that the small intercalar which does not extend to the prootic is the derived condition. Judging from this assumption, the condition of the small intercalar is the synapomorphy for all cottoid fishes. Among the other scorpaeniform fishes examined, the derived condition of this character is observed in the anoplomatid and the cyclopteroid fishes. In the other scorpaeniform fishes, the intercalar is present as a large bone which extends to the prootic. Quast (1965) reported that small intercalar is observed in a hexagrammid fish *Ophiodon*. It is concluded that the condition of the small intercalar is the synapomorphy of the cottoid fishes, but it is not unique condition among the scorpaeniform fishes.

Posttemporal fossa: All cottoid fishes examined here are possessed of well reduced posttemporal fossa as compared with that of the generalized percoid fishes (Gregory, 1933 ; Katayama, 1959 ; Patterson, 1964 ; Tominaga, 1968). In most of the cottoid fishes, the lateral insertion head of the epaxialis does not extend to the posttemporal fossa, while well developed lateral head of the epaxialis inserts to the posttemporal fossa in the generalized percoid fishes (Osse, 1969 ; Winterbottom, 1974a). It is considered that the reduced posttemporal fossa is the derived condition of the all cottoid fishes. Among the scorpaeniform fishes examined, the reduced posttemporal fossa is observed in the cyclopterid and the liparidid fishes.

On the basis of the conditions of the cranium, the cottoid fishes are classified into 17 morphotypes summarized in Table 2.

3. JAWS (Figs. 14 and 15)

Description. The upper jaw is composed of the premaxillary and the maxillary. The lower jaw is composed of the dentary, the angular, the retroarticular, the coronomeckelian and the meckelian cartilage.

Premaxillary (PM): The premaxillary is situated on the anterior margin of

the upper jaw. This bone is possessed of four processes. The alveolar process (ALP) forms the lower margin of this bone and bears villiform teeth. The ascending process (ACT) is situated on the anterior midline and connected with its antimere. This process is directed upward or upper backward in most of the cottoid fishes, while it is directed upper forward in an agonid genus *Podothecus*. This process attaches to the rostral cartilage, which is articulated with the rostral region of the cranium, and is ligamentously connected with the maxillary head (Fig. 15, L-3) and the palatine (Fig. 15, L-2). The articular process (ARP) is a plate-like projection situated just posterior to the ascending process. This process is articulated with the maxillary head with a meniscus. The postmaxillary process (PMP) is a gently swelling process on the posterodorsal margin of the alveolar process. These processes are usually developed in the cottoid fishes.

Maxillary (MX): The maxillary is an elongated and slightly curved bone. The anterior tip of this bone which is called the maxillary head (MH) is modified to form some articular facets. The maxillary head has a median groove where the maxillary is articulated with the articular process of the premaxillary through a meniscus. Medially the maxillary head is articulated with the anterolateral surface of the rostral region of the cranium with a meniscus. Laterally the maxillary head is articulated with the anterior process of the palatine. Some ligaments and tendons insert to the maxillary. The ligament coming from the ethmoid (Fig. 15, L-1) inserts to the lateral surface of the maxillary head. The ligament coming from the ascending process of the premaxillary (Fig. 15, L-3) inserts to the dorsal surface of the maxillary head. The ligamentum primordium (Fig. 15, T-2) inserts to the small knob situated on the anterolateral surface of the maxillary. The tendon of the adductor mandibulae section A1 (Fig. 15, T-1) inserts to the small knob situated on the anteromedial surface of the maxillary head. These conditions are uniform in the cottoid fishes examined.

Dentary (DEN): The dentary forms the anterior margin of the lower jaw. This bone possesses villiform teeth on the dorsal margin. On the ventral margin, this bone is possessed of a well developed tubular structure for the mandibular sensory canal. Posteriorly, this bone has a deep notch where the angular and the meckelian cartilage insert.

Angular (ANG): The angular forms the posterior half of the lower jaw. Anteriorly this bone is rigidly lodged into a deep notch of the dentary. On the posterodorsal angle, this bone possesses the fossa which receives the condyle of the quadrate to form the quadroangular articulation. On the posterodorsal margin just anterior to the fossa, this bone possesses an ascending process (APA) which is connected with the posterodorsal tip of the dentary by a ligamentous tissue and inserted by the muscle of the adductor mandibulae section A2. The ascending process is not developed in the agonid fishes. On the medial surface, this bone is filled with the muscular mass of the adductor mandibulae section Aw. Posteroventrally this bone has developed tubular structure for the mandibular sensory canal.

Retroarticular (RTA): The retroarticular forms the posteroventral angle of the lower jaw. This bone adheres to the posteroventral corner of the angular. This bone is ligamentously connected with the interopercle posteriorly.

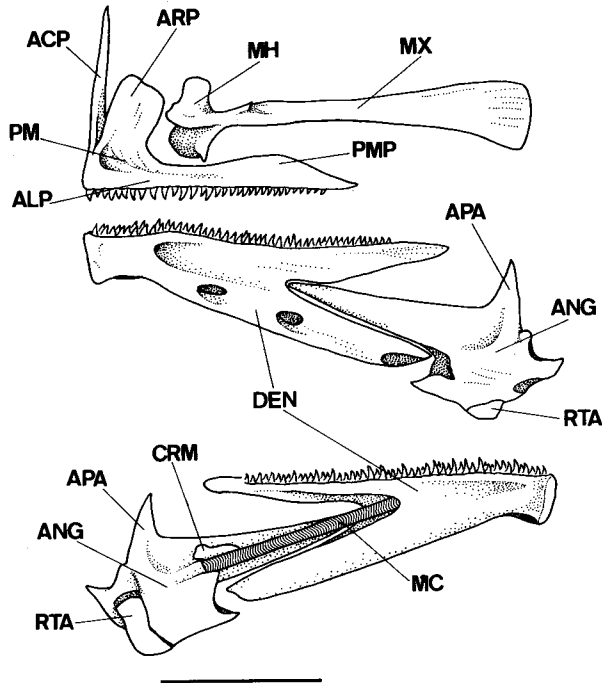

Fig. 14. Jaws in *Gymnocanthus herzensteini*; above, lateral aspect of the upper jaw; middle, lateral aspect of the lower jaw; below, medial aspect of the lower jaw. ACP, ascending process of premaxillary; ALP, alveolar process of premaxillary; ANG, angular; APA, ascending process of angular; ARP, articular process of premaxillary; CRM, coronomeckelian; DEN, dentary; MC, meckelian cartilage; MH, maxillary head; MX, maxillary; PM, premaxillary; PMP, postmaxillary process of premaxillary. Scale indicates 10 mm.

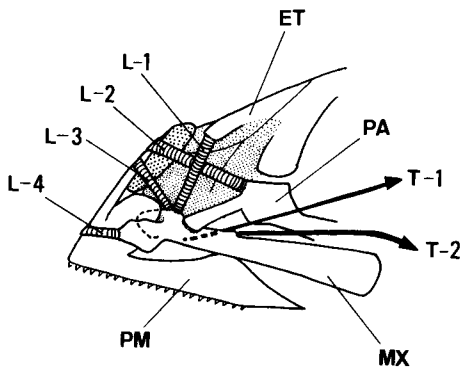

Fig. 15. Distribution of ligaments and tendons in the rostral region of the cottoid fishes. ET, ethmoid; MX, maxillary; PA, palatine; PM, premaxillary; L-1, ligament between ethmoid and maxillary; L-2, ligament between palatine and ascending process of premaxillary; L-3, ligament between ascending process of premaxillary and maxillary head; L-4, ligament between maxillaries of both sides; T-1, tendon of the adductor mandibular section A-1; T-2, tendon of the ligamentum primordium.

Coronomeckelian (CRM): The coronomeckelian is present as a tiny bone situated on the medial surface of the angular. This bone is inserted by the strong tendon of the adductor mandibulae section A2.

Meckelian cartilage (MC): The meckelian cartilage is a rodlike cartilaginous bone situated on the medial surface of the angular. This cartilaginous bone interconnects the angular and the dentary.

Remarks. In the cottoid fishes examined here, the condition of the jaws is almost uniform. These conditions are common with those of the generalized percoid fishes (Davis and Birdson, 1973; Gosline, 1961; Osse, 1969; Leim, 1970). The patterns of the articulation and the ligamentation of this region in the cottoid fishes are almost similar to those in the generalized percoid fishes (Alexander, 1967; Osse, 1969; Liem, 1970).

4. SUSPENSORIUM AND OPERCULAR BONE (Figs. 16-18; Table 3)

Description. The suspensory apparatus is composed of seven elements; the hyomandibular, the quadrate, the symplectic, the metapterygoid, the entopterygoid, the ectopterygoid and the palatine. The opercular apparatus is composed of four elements; the opercle, the subopercle, the interopercle and the preopercle.

Hyomandibular (HM): The hyomandibular is a heavy bone and rectangular or quadrate in general form. This bone possesses two articular heads dorsally for the craniohyomandibular articulations. The anterior head is directed anterodorsally and lodged in a rounded socket of the sphenotic. The posterior one is directed posterodorsally and fits into longitudinal groove of the pterotic. Posterodorsally, this bone possesses a rounded knob which are articulated with anterior head of the opercle to form the operculohyomandibular articulation. This bone is suturally connected to the metapterygoid anteroventrally, and firmly attached to the preopercle posteroventrally. This bone is separated from the symplectic by the cartilaginous interval. In the fishes belonging to the family Cottidae, the hyomandibular possesses a lateral process at the posterior margin. This process is inserted by the tendon from the adductor mandibulae section A1, and is remarkably developed in the fishes belonging to the genera *Artedius*, *Artediellus*, *Artediellichthys*, *Oligocottus*, *Clinocottus*, *Chitonotus*, *Cottus*, *Hemilepidotus*, *Jordania*, *Leiocottus*, *Leptocottus*, *Ocynectes*, *Orthonopias*, *Scorpaenichthys*, *Stlengis*, *Synchirus* and *Zesticelus*. In the fishes belonging to the families Psychrolutidae, Agonidae, Ereuniidae, and Rhamphocottidae, this process is obscure. There is a foramen on the posteroventral margin of the hyomandibular where the hyomandibular branch of the facialis nerve passes.

Metapterygoid (MT): The metapterygoid is a thin bone, rather quadrate or rectangular in general form. This bone is suturally connected with the hyomandibular posterodorsally. This bone is separated from the symplectic and the quadrate by the cartilaginous interval. In many cottoid fishes examined, this bone is attached or closely approached to the entopterygoid anteriorly, while it is far separated from the latter in the fishes of the genera *Artediellus*, *Artediellichthys*, *Cottiusculus*, *Furcina*, *Icelinus*, *Pseudoblennius*, *Vellitor*, *Zesticelus*, *Stlengis* and *Triglops*. On the medial surface of the metapterygoid, there is a low ridge which defends against the extension of the adductor arcus palatini. This ridge is partly

developed to form a small process in *Clinocottus*, *Scorpaenichthys*, *Stelgistrum*, *Asemichthys* and *Radulinus*. In all cottoid fishes examined, the metapterygoid lamina is absent.

Symplectic (SY): The symplectic is a slender and slightly curved bone, becoming gradually broader posteriorly. This bone lies in the interspace among the hyomandibular, the metapterygoid and the preopercle. The anterior half of this bone is lodged in a groove on the medial surface of the lower part of the quadrate and firmly fixed there. There is a large gap between the symplectic and preopercle where the mandibular branch of the trigeminal nerve passes.

Quadrate (QU): The quadrate is a heavy triangular bone. On the anteroventral corner, this bone possesses a large condyle which is directed anteroventrally and lodged in a rounded socket of the angular to form the quadromandibular articulation. The quadrate is deeply notched at the lower part of the posterior margin where the symplectic inserts. This bone is firmly connected with the ectopterygoid on the anterior margin, and with the preopercle on the posteroventral margin.

Ectopterygoid (EC): The ectopterygoid is a slender triangular bone in general form. This bone is connected with the palatine anteroventrally, with the quadrate posteriorly and with the entopterygoid, when it is present, dorsally. A strong ligament interconnects the anteromedial tip of the ectopterygoid and the anterolater-

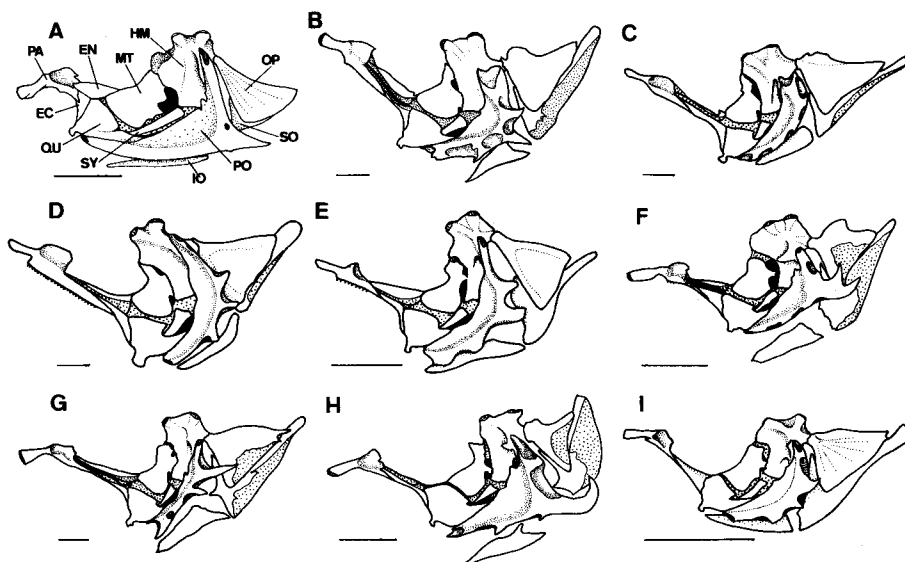

Fig. 16. Lateral aspect of left suspensorium and opercular bones. A, *Rhamphocottus richardsoni*; B, *Dasycottus setiger*; C, *Eurymen gyrinus*; D, *Hemitripterus villosus*; E, *Blepsias cirrhosus*; F, *Oligocottus maculosus*; G, *Myoxocephalus brandti*; H, *Artediellus dydymovi*; I, *Asemichthys taylori*. EC, ectopterygoid; EN, entopterygoid; HM, hyomandibular; IO, interopercle; MT, metapterygoid; OP, opercle; PA, palatine; PO, preopercle; QU, quadrate; SY, symplectic. Scales indicate 5 mm.

al corner of the prevomer. In most of the cottoid fishes examined, the ectopterygoid is separated from the metapterygoid by the cartilaginous interval. In the fishes belonging to the genera *Cottus*, *Leptocottus*, *Trachidermus* and *Scorpaenichthys*, a laminal process is present on the posterodorsal corner of the medial surface of the ectopterygoid and extends to the interspace between the entopterygoid and the metapterygoid. In the *Scorpaenichthys*, this laminal process attaches to the metapterygoid.

Entopterygoid (EN): The entopterygoid is a slender triangular bone in general form. This bone lies dorsal to the ectopterygoid and attaches to the palatine anteriorly. The cottoid fishes examined here are classified into three morphotypes on the basis of the condition of this bone. Type A includes the most of the cottoid fishes. In this type, the entopterygoid attaches or closely approaches to the metapterygoid posteriorly. Type B includes the fishes of the genera *Artediellus*, *Artedihellichthys*, *Cottiusculus*, *Furcina*, *Pseudoblennius*, *Vellitor*, *Zesticelus*, *Icelinus*, *Stlengis*, *Triglops* and *Tilesina*. In this type, the entopterygoid is well reduced to form a tiny bone, and far separated from the metapterygoid. Type C includes the fishes of the genera *Synchirus*, *Asemichthys*, *Radulinus*, *Astrocottus* and *Trachidermus*. In this type, the entopterygoid is absent.

Palatine (PA): The palatine is a heavy bone. This bone possesses a long process anteriorly which is attached by a strong ligament coming from the ascending process of the premaxillary. On the middle region, this bone has a socket which receives the articular knob of the lachrymal and forms the lachryopalatine articulation. In the fishes of the genera *Vellitor*, *Synchirus* and *Tilesina*, this socket is not developed, but the lachryopalatine articulation is present. The dorsal region of this socket is laminated, and connected to the posterior surface of the prefrontal by a ligamentous tissue. There is an articular facet for the palatocranial articulation on the dorsal base of the anterior process in the fishes of the genus *Rhamphocottus*, *Jordania*, *Hemilepidotus*, *Hemitripterus*, *Blepsias*, *Nautichthys* and *Scorpaenichthys*. In the other fishes examined, the articular facet is reduced and the palatocranial articulation is obscure. This bone becomes slender posteriorly and is firmly connected with the ectopterygoid. Anterior tip of the entopterygoid inserts to the medial face of the palatine. The oral surface of the palatine bears villiform or conical teeth in the genera *Alcichthys*, *Artediellus*, *Artedius*, *Ascelichthys*, *Bero*, *Blepsias*, *Chitonotus*, *Clinocottus*, *Cottiusculus*, *Cottus kazika*, *Ereunias*, *Furcina*, *Hemilepidotus*, *Hemitripterus*, *Icelinus*, *Icelus*, *Jordania*, *Leptocottus*, *Marukawichthys*, *Nautichthys*, *Ocynectus*, *Oligocottus*, *Orthonopias*, *Pseudoblennius*, *Ricuzenius*, *Scorpaenichthys*, *Stlengis*, *Thyriscus*, *Trachidermus*, *Taurocottus*, *Vellitor*, *Agonomalus* and *Tilesina*. Other species examined here do not have teeth on the palatine.

Preopercle (PO): The preopercle is the largest bone in the opercular region. The upper half of this bone is firmly attached to the posterior margin of the hyomandibular and the anterior part of this bone is firmly attached to the ventral margin of the quadrate. Anterolateral part of this bone is usually convex at the middle part where the muscle fibers of the adductor mandibulae are broadly inserted. There is a developed tubular structure along the posterior margin of the preopercle, through which the sensory canal of the operculomandibular series passes. In the most of the cottoid fishes, large spines are present on the posterior margin of

the preopercle. The general form of the preopercular spines is defined into three main types and their variations in the cottoid fishes. Type A is the condition possessing four or five preopercular spines. These spines are simple and not elongated. The second spine is slightly longer than the others. This type includes the fishes of the genera *Hemitripterus*, *Blepsias*, *Nautichthys*, *Jordania*, *Hemilepidotus*, *Malacocottus*, *Dasycottus*, *Cottunculus* and the family Ereuniidae. Type B is the condition possessing the elongated first preopercular spine which is more or less modified. This type is subdivided into four subtypes. Subtype B1 is the condition that the first preopercular spine is not so extending backward, and is straight or slightly curved. This subtype includes the fishes of the genera *Argyrocottus*, *Artedius*, *Asemichthys*, *Clinocottus*, *Furcina*, *Icelus*, *Leptocottus*, *Microcottus*, *Ocynectus*, *Oligocottus*, *Porocottus*, *Pseudoblennius*, *Radulinus*, *Ricuzenius*, *Scorpaenichthys*, *Stelgistrum*, *Synchirus*, *Thryscus*, *Triglops*, *Vellitor*. Subtype B2 is the condition that the first preopercular spine is long and straight without ascending spines. This subtype includes the fishes of the genera *Myoxocephalus*, *Taurocottus*, *Trichocottus*, and *Zesticulus*. Subtype B3 is the condition that the first spine is strongly curved upward. This subtype includes the fishes of the genera *Artediellus*, *Artediellichthys*, *Ascelichthys*, *Bero*, *Cottus*, *Trachidermus*. Subtype B4 is the condition that small spines are present on the dorsal margin of the first preopercular spine. This type includes the fishes of the genera *Alcichthys*, *Chitonotus*, *Cottiusculus*, *Enophrys*, *Gymnocanthus*, *Icelinus*, *Leptocottus*, and *Stlenqis*. Type C includes the fishes of the genera *Ebinania*, *Eurymen*, and *Psychrolutes*. In this type, the preopercular spine is absent.

Opercle (OP): The opercle is a large flat bone and generally triangular in form. On the anterodorsal angle, this bone has a large condyle which articulates to the hyomandibular. On the anteroventral margin, this bone is firmly attached to the subopercle. This bone possesses a keel on the dorsomedial margin where the muscular fibers of the levator operculi and the adductor operculi insert.

Subopercle (SO): The subopercle is a thin and narrow bone, and firmly attaches to the opercle. Anteroventrally, this bone is connected with the interopercle by ligamentous tissue.

Interopercle (IO): The interopercle is a long and thin bone, and lies under the anterior part of the preopercle. This bone is connected with the retroarticular by a strong ligament anteriorly, and with the subopercle by a ligamentous tissue posteriorly. Medially, this bone is ligamentously connected with the epiphyal.

Discussion. The osteology of the suspensory and the opercular apparatus of the cottoid fishes has been examined by Girard (1852), Allis (1909), Gutberlet (1915), Johnson (1918), Watanabe (1958), and Yabe (1981, 1983). The conditions of the palatine teeth and the preopercular spines have been regarded as the important characters for the identification of the cottoid fishes (Jordan and Evermann, 1898; Jordan and Starks, 1904; Taranetz, 1941; Bolin, 1947; Matsubara, 1955; Watanabe, 1958). The other conditions of this region have been scarcely remarked. Among cottoid fishes examined here, the differences were found in the conditions of the palatocranial articulation (discussed in the section of the cranium), the entopterygoid, the palatine teeth, the lateral process of the hyomandibular and the preopercular spine. In addition to these characters, the condition of the metapterygoid

lamina is also discussed below, because it is absent in all cottoid fishes examined, but present in the generalized percoid fishes.

Condition of the entopterygoid: Among the cottoid fishes examined here, these are three types in this character (Fig. 17). Type A is the condition that the entopterygoid is attached or closely approached to the metapterygoid posteriorly. Type B is the condition that the entopterygoid is far separated from the metapterygoid. Type C is the condition that the entopterygoid is absent. In the generalized percoid fishes, the entopterygoid is a oval bone and attaches to the metapterygoid posteriorly (Gregory, 1933; Katayama, 1959; Gosline, 1966; Osse, 1969; Bortone, 1977). It, therefore, is considered that type A is the most primitive condition in the cottoid fishes. It is estimated that the reduction of the entopterygoid have occurred from the condition of type A and as a result of this tendency, type B and the type C successively occurred. Thus it is defined that type B is the intermediate derived condition and type C is the most derived condition.

Among the other scorpaeniform fishes, the fishes of the families Scorpaenidae, Synanceiidae, Platycephalidae, Hexagrammidae; Zaniolepididae and Anoplopomatidae have a large oval entopterygoid which is attached to the metapterygoid posteriorly (Allis, 1909; Matsubara, 1943; Matsubara and Ochiai, 1955; Quast, 1965). In the triglid fishes, the entopterygoid is small bone and separated from the palatine anteriorly and closely approached to the metapterygoid posteriorly. In the cyclopterid and the liparidid fishes, the entopterygoid is fused to the ectopterygoid (Ueno, 1970).

Preopercular spine: Among the cottoid fishes examined, the condition of the preopercular spines is highly modified. These conditions are defined into three main types. Type A is the condition having four of five spines which are simple or slightly flattened. The second spine is slightly larger than others. Type B is the condition having a large first spine which is simple or highly modified. Type C is condition lacking the preopercular spines. In the generalized percoid fishes, these types are also present (Katayama, 1959; Gosline, 1966; Johnson, 1983). Therefore, the polarity of this character could not be decided. Thus, this character is not used in the following phylogenetic consideration.

Teeth on palatine: Among the cottoid fishes examined, there are two types in this character. Type B is the condition possessing teeth on the palatine. Type C is the condition lacking teeth on the palatine. In the generalized percoid fishes, the

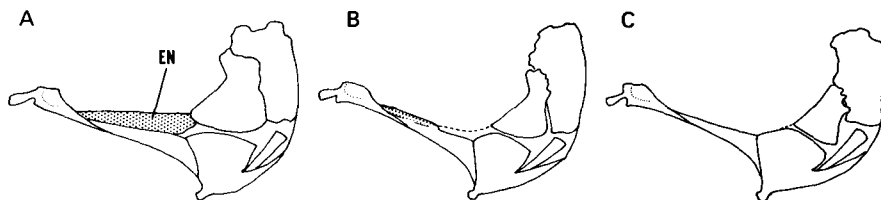

Fig. 17. Three types of the entopterygoid in the cottoid fishes. A, the condition that the entopterygoid is attached the metapterygoid (type A in text); B, the condition that the entopterygoid is reduced (type B in text); C, the condition that the entopterygoid is absent (type C in text). EN, entopterygoid.

palatine teeth is present (Jordan and Evermann, 1898; Katayama, 1959). It, therefore, is considered that the condition possessing teeth on the palatine is the primitive condition in the cottoid fishes.

Among the other scorpaeniform fishes, the palatine teeth are present in the scorpaenid, platycephalid, triglid, zaniolepidid fishes, while it is absent in the cyclopterid, liparidid and most of hexagrammid fishes.

Lateral process of hyomandibular: Among the cottoid fishes examined here, the fishes of the family Cottidae have a lateral process on the posterior margin of the hyomandibular. A strong tendon of the adductor mandibulae section A1 attaches to the lateral process. In the fishes of the other families this process is obscure. In the generalized percoid fishes, the lateral process of the hyomandibular is not observed (Starks, 1901; Katayama, 1959; Gosline, 1966; Osse, 1969; Bortone, 1977). It, therefore, is considered that the condition possessing the lateral process on the hyomandibular is derived in the cottoid fishes. Moreover, this condition may be unique and derived condition, because it has not been observed in the other scorpaeniform fishes examined.

Matapterygoid lamina: In the most of the generalized percoid fishes, the matapterygoid lamina which was termed by Matsubara (1943) is present on the lateral surface of the matapterygoid (Starks, 1901; Katayama, 1959; Bortone, 1977). There is a shallow groove between the matapterygoid lamina and the dorsal part of the matapterygoid, and the muscular fibers of the levator arcus palatini insert to this groove (Osse, 1969). The matapterygoid lamina is absent in the all cottoid fishes examined. It, therefore, is considered that the absence of the matapterygoid lamina is the derived condition in comparison with the condition in the generalized percoid fishes.

On the other hand, Matsubara (1943) found that the matapterygoid lamina is present in the most of the scorpaenoid fishes except for the fishes belonging to the genera *Apistus*, *Ocosia*, *Hypodytes*, *Cocotropus*, *Erisphex*, *Aploactis*, *Neocentropogon*, *Minous*, *Erosa* and *Inimicus*. Platycephalid fishes are possessed of the matapter-

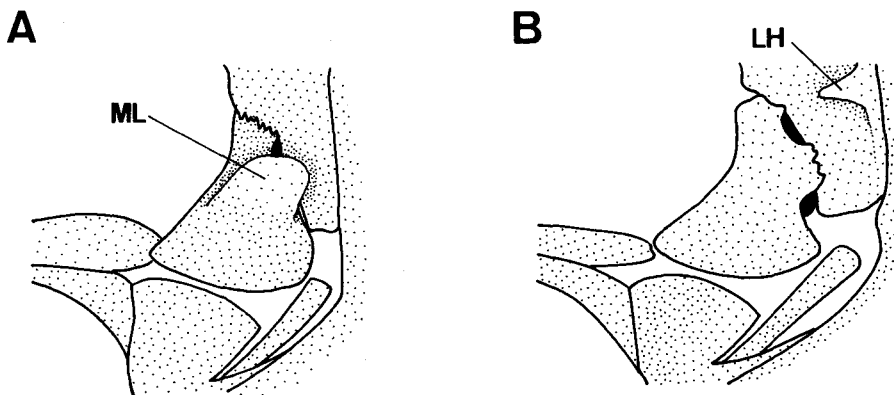

Fig. 18. Comparison of the matapterygoid and the hyomandibular between the generalized percoid fishes (A) and the cottoid fishes (B). ML, matapterygoid lamina; LH, lateral process of the hyomandibular.

Table 3. Comparison of three characters of the suspensory apparatus in the cottoid fishes. ENP, entopterygoid ; PAT, palatine teeth ; LPH, lateral process of the hyomandibular. P, primitive condition ; D, derived condition (D1 < D2).

Morphotype	Character						Family and genus
	ENP		PAT				
I	normal	P	absent	D	absent	P	Rhamphocottidae; <i>Rhamphocottus</i> Agonidae; <i>Podothecus</i> Psychrolutidae; <i>Dasycottus</i> , <i>Eurymen</i> , <i>Ebinania</i> , <i>Cottunculus</i> , <i>Malacocottus</i> , <i>Neophrynichthys</i> , <i>Psychrolutes</i>
II			present	P			Ereuniidae; <i>Marukawichthys</i> , <i>Ereunias</i> Hemitripterae; <i>Hemitripterus</i> , <i>Blepsias</i> , <i>Nautichthys</i> Agonidae; <i>Agonomalus</i>
IV	normal	P	absent	D	present	D	Cottidae; <i>Scorpaenichthys</i> , <i>Hemilepidotus</i> , <i>Leiocottus</i> , <i>Cottus kazika</i> , <i>Arteidius</i> , <i>Chitonotus</i> , <i>Orthonopias</i> , <i>Icelus</i> , <i>Ricuzenius</i> , <i>Thyriscus</i> , <i>Oligocottus</i> , <i>Clinocottus</i> , <i>Alcichthys</i> , <i>Bero</i> , <i>Ocynectes</i> , <i>Ascelichthys</i> , <i>Taurocottus</i>
V							Cottidae; <i>Stelgistrum</i> , <i>Leiocottus</i> , <i>Gymnocanthus</i> , <i>Trichocottus</i> , <i>Cottus pollux</i> <i>Myozocephalus</i> , <i>Microcottus</i> , <i>Porocottus</i> , <i>Argyrocottus</i> , <i>Enophrys</i> , <i>Taurulus</i>
VI	reduced	D1	present	P	present	D	Cottidae; <i>Icelinus</i> , <i>Silengis</i> , <i>Arteidiellus</i> , <i>Arteidiellichthys</i> , <i>Cottiusculus</i> , <i>Furcina</i> , <i>Pseudoblennius</i> , <i>Vellitor</i>
VII			absent	D			Cottidae; <i>Zesticelus</i>
VIII	absent	D2	absent	D	present	P	Cottidae; <i>Asemichthys</i> , <i>Radulinus</i> , <i>Astrocottus</i> , <i>Synchirus</i>
IX							present

ygoid lamina (Matsubara and Ochiai, 1955). Among other scorpaeniform fishes examined here, the metapterygoid lamina is present in the hexagrammid, zaniolepidid, triglid and anoplomatid representatives, but it is absent in the cyclopterid and liparidid representatives.

On the basis of the conditions of this region, the cottoid fishes are classified into 9 morphotypes summarized in Table 3.

5. HYOID APPARATUS (Figs. 19-21 ; Table 4)

Description. The hyoid apparatus is composed of the basihyal, the hypohyal, the ceratohyal, the epihyal, the interhyal, the urohyal and the branchiostegal rays.

Basihyal (BH): This bone is present in *Rhamphocottus richardsoni* and *Jordania zonope*, while it is absent in the other cottoid fishes. In *Rhamphocottus*, this bone is present as small bone which is not completely ossified and situated at the anterior tip of the hypohyal (Fig. 19). In *Jordania*, this bone is present as a tiny bone which is sandwiched between dorsal hypohyals of both sides (Fig. 21, C).

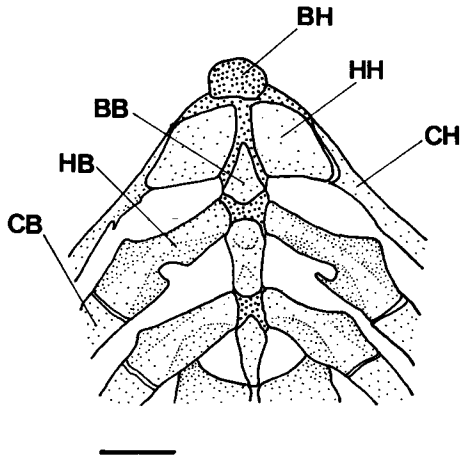

Fig. 19. Oral surface of the branchial and hyoid apparatus in *Rhamphocottus richardsoni*. BB, basibranchial; CB, ceratobranchial; HB, hypobranchial; BH, basihyal; CH, ceratohyal; HH, hypohyal. Scale indicates 2 mm.

Hypohyal (HH): In the cottoid fishes examined, two hypohyals are present on each side, and form the anterodorsal corner of the hyoid region. The ventral hypohyal is a stout triangular bone. This bone is connected with its opposite member on the median line through the cartilage, and with the urohyal by a strong ligament ventrally, and attaches to the ceratohyal posteroventrally. The dorsal hypohyal is a plate-like bone and situated on the cartilaginous mass of the anterior hyoid region.

Ceratohyal (CH): The ceratohyal is the largest bone in the hyoid apparatus and is rectangular in general form. This bone intervenes between the hypohyals and the epihyal. This bone articulates anterior branchiostegals ventrally. At the anterodorsal margin, this bone is connected with the lateral process of the first hypobranchial by a ligamentous tissue. In all examined species except for *Jordania zonope*, the dorsal margin of this bone is generally shallowly concave, while it is deeply notched at the posterior half in *Jordania zonope*. The hyoid artery passes through this notch in this species. In almost all cottoid fishes examined, this bone

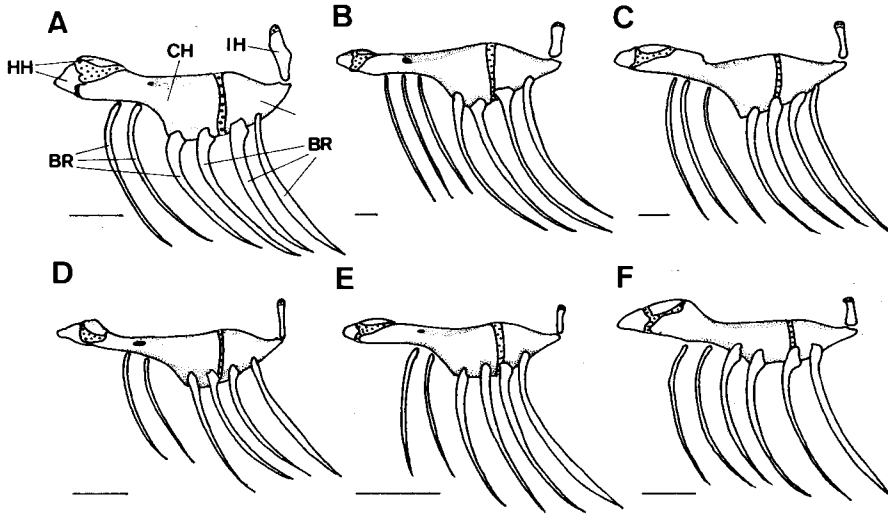

Fig. 20. Lateral aspect of the left hyoid arch. A, *Hemitripterus villosus*; B, *Dasycottus setiger*; C, *Malacocottus gibber*; D, *Icelus spiniger*; E, *Triglops scepticus*; F, *Cottus pollux*. BR, branchiostegal ray; CH, ceratohyal; EH, epihyal; HH, hypohyal; IH, interhyal. Scales indicate 5 mm.

possesses a small slit penetrated by the hyoid artery. This slit is absent in the fishes of genera *Artediellus*, *Artediellichthys*, *Cottiusculus*, *Cottus*, *Trachidermus*, and *Zesticelus*, and the family Agonidae. In these fishes, this bone has a groove on the anterodorsal margin where the hyoid artery passes.

Epihyal (EH): The epihyal is a stout triangular bone. This bone is connected with the ceratohyal anteriorly and articulates the interhyal posteriorly. Anteroventrally, this bone supports the posterior two branchiostegal rays. Posterolaterally this bone possesses of a small process where the ligament coming from the interopercle is inserts.

Interhyal (IH): The interhyal is a small rod-shaped bone. This bone fits in a small groove on the posterodorsal tip of the epihyal ventrally. Dorsally the interhyal is connected to the medial surface of the cartilaginous region enclosed by the hyomandibular, the symplectic and the preopercle.

Branchiostegal rays (BR): Branchiostegal rays are long curved bones supporting the branchiostegal membranes. Among cottoid fishes examined here, the number of the branchiostegal rays is defined into two types. Type A has seven brachiostegal rays. This condition is observed in all species belonging to the family Psychrolutidae. In this type anterior three rays are more slender than the posterior four rays, and attach to the ventral margin of the ceratohyal. The fourth and fifth rays attach to the ventrolateral surface of the posterior half of the ceratohyal. The sixth and seventh rays attach to the ventrolateral surface of the epihyal. Type B has six brachiastegal rays. In this type, the anterior two rays attach to the ventral margin of the anterior half of the ceratohyal. The third and fourth rays attach on the ventrolateral surface of the posterior half of the ceratohyal, and the fifth and sixth rays are on the ventrolateral surface of the epihyal. This type is observed in

most of the cottoid fishes except for the psychrolutid fishes.

Discussion. The hyoid apparatus of the cottoid fishes has been examined by some investigators (Girard, 1852; Johnson, 1918; Taranetz, 1941; Watanabe, 1958; Quast, 1965; McAllister, 1968; Yabe, 1981, 1983). In these studies, the number of the branchiostegal rays has been remarked. Among the cottoid fishes examined here, the differences are found in the condition of the basihyal, number of the branchiostegal rays and presence or absence of the slit on the ceratohyal.

Condition of basihyal: Among the cottoid fishes examined, there are three types in this character as described above. Type A is a small cartilaginous basihyal situated at the anterior tip of the hypohyal (Fig. 21, B). Type B is a tiny basihyal sandwiched between the dorsal hypohyals (Fig. 21, C). Type C is the condition that the basihyal is absent (Fig. 21, D). In the generalized percoid fishes, the basihyal is a long rod-shaped bone and situated at the anterior tip of the hypohyal (Fig. 21, A; Katayama, 1959; Gosline, 1966; McAllister, 1968; Nelson, 1969; Liem, 1970; Johnson, 1978). It, therefore, is considered that type A is the most primitive condition of the basihyal in the cottoid fishes, and that type B is intermediate derived condition, and type C is the most derived condition. On the other hand, the basihyal of the type A is more reduced than that of the generalized percoid fishes. Thus, it is regarded that type A is more derived condition than that of the generalized percoid fishes.

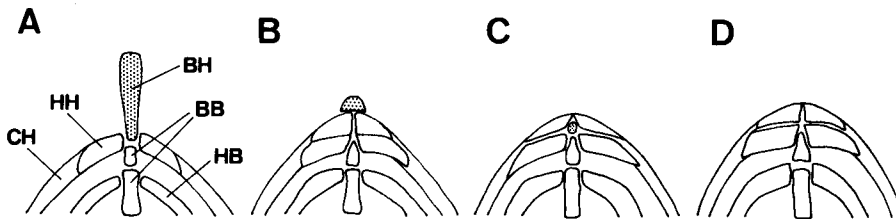

Fig. 21. The comparison of the basihyal. A, the condition in the generalized percoid fishes; B, the condition in *Rhamphocottus richardsoni* (type A in text); C, the condition in *Jordania zonope* (type B in text); D, the typical condition in the cottoid fishes (type C in text). For abbreviations, see Fig. 19.

Among the other scorpaeniform fishes, a long rod-like basihyal is present in the scorpaenoid, triglid, hexagrammid, zaniolepidid and anoplomatid fishes, while it is absent in the cyclopterid and liparidid fishes (Matsubara, 1943; Quast, 1965; McAllister, 1968). The platycephalid fishes are possessed of a plate-like basihyal (Matsubara and Ochiai, 1955). According to Kanayama (1977, unpublished), a rudimental basihyal is present in two agonid genus *Podotheucus* and *Sarritor*, though it is not observed in three agonid representatives examined here.

Number of the branchiostegals: Among cottoid fishes examined, there are two types in this character. Type A is seven branchiostegal rays, and type B is six rays. The former is observed in the psychrolutid fishes, and the latter is in the other cottoid fishes. According to Katayama (1959), almost all generalized percoid fishes have seven branchiostegal rays, and only one genus *Callanthias*, which has been regarded as a highly specialized group of the Serranidae or not direct serranid

Table 4. Comparison of two characters of the hyoid arch in the cottoid fishes. BH, basihyal; BR, number of branchiostegal rays. P, primitive condition; D, derived condition (D1 < D2).

Morphotype	Character		Family and genus
	BH	BR	
I	cartilaginous	P	Rhamphocottidae; <i>Rhamphocottus</i>
II	tiny bone	D1	Cottidae; <i>Jordania</i>
III	absent	D2	Ereuniidae; <i>Erenunias</i> , <i>Marukawichthys</i> Agonidae; <i>Agonomalus</i> , <i>Podothecus</i> , <i>Tilesina</i> Hemitripteridae; <i>Hemitripterus</i> , <i>Blepsias</i> , <i>Nautichthys</i> Cottidae; <i>Scorpaenichthys</i> , <i>Hemilepidotus</i> , <i>Cottus</i> , <i>Trachidermus</i> , <i>Leptocottus</i> , <i>Chitonotus</i> , <i>Orthonoptas</i> , <i>Icelus</i> , <i>Stelgistrum</i> , <i>Stlengis</i> , <i>Icelinus</i> , <i>Thyriscus</i> , <i>Ricuzenius</i> , <i>Triglops</i> , <i>Radulinus</i> , <i>Asemichthys</i> , <i>Astrocottus</i> , <i>Artedius</i> , <i>Ohgocottus</i> , <i>Clinocottus</i> , <i>Leiocottus</i> , <i>Synchirus</i> , <i>Artediellus</i> , <i>Artediellichthys</i> , <i>Cottiusculus</i> , <i>Zesticlus</i> , <i>Taurocottus</i> , <i>Trichocottus</i> , <i>Myoxocephalus</i> , <i>Microcottus</i> , <i>Porocottus</i> , <i>Argyrocottus</i> , <i>Enophrys</i> , <i>Taurulus</i> , <i>Gymnocanthus</i> , <i>Alcichthys</i> , <i>Bero</i> , <i>Ocymectes</i> , <i>Furcina</i> , <i>Pseudoblennius</i> , <i>Velutitor</i> , <i>Ascelichthys</i>
IV		7 P	Psychrolutidae; <i>Dasycottus</i> , <i>Eurymen</i> , <i>Ebinania</i> , <i>Cottunculus</i> , <i>Malacocottus</i> , <i>Neophrymichthys</i> , <i>Psychrolutes</i>

derivatives (Katayama, 1959; Gosline, 1966), has six branchiostegal rays. It, therefore, is considered that the typical condition in the generalized percoid fishes is possessed of seven branchiostegal rays. Judging from this fact, it can be regarded that type A is the primitive condition in the cottoid fishes. It has been considered that the condition possessing seven branchiostegal rays is one of the important characters defining the family Psychrolutidae (Taranetz, 1941; Nelson, 1982). On the basis of the conception of the synapomorphy, this condition is not a certain evidence which verifies the monophyly of the psychrolutid fishes, because it is the synplesiomorphous condition for the psychrolutid fishes.

Among other scorpaeniform fishes, the condition of seven rays is observed in most of scorpaenid, platycephalid and triglid fishes, and that of six rays is observed in some of the scorpaenid fishes, and the hexagrammid, zaniolepidid, anoplopomatid, cyclopterid and liparidid fishes (Matsubara, 1943; Matsubara and Ochiai, 1955; Rutenberg, 1962; Quast, 1965; McAllister, 1968; Ueno, 1970).

Slit on ceratohyal: Among the cottoid fishes examined, there are three conditions in this character. Most of cottoid fishes are possessed of a small slit on the anterolateral surface of the ceratohyal. In *Jordania*, a large notch is present on the dorsal margin of the ceratohyal. The slit or notch is absent in the agonid and some of cottid fishes. These three conditions are present in the generalized percoid fishes (Katayama, 1959). Gosline (1966) regarded these conditions as the difference between the serranids, in which the slit is absent, and the percichthyids in which

large slit is present. Therefore, the polarity of this character can not be decided in the present study. But it is noteworthy that the condition possessing a slit penetrated by the hyoid artery on the ceratohyal has not been observed in the other scorpaeniform representatives.

On the basis of the conditions of the hyoid apparatus, the cottoid fishes are classified into four morphotypes summarized in Table 4.

6. BRANCHIAL APPARATUS (Figs. 22-24 ; Table 5)

Description. The branchial apparatus is composed of the basibranchial, the hypobranchial, the ceratobranchial, the epibranchial and the pharyngobranchial.

Basibranchial (BB): The basibranchials are three small rodlike bones lying on the median line of the oral base and connected with each other through intervening of the cartilage. The anteriormost basibranchial is smaller than the latter, and is sandwiched between the dorsal hypohyals or gets under the cartilage of the anterior hyoid region. The second basibranchial articulates the first hypobranchial anterolaterally. The third basibranchial does not directly articulate to the hypobranchials. It is connected with the central cartilage posteriorly.

Hypobranchial (HB): The hypobranchials are three paired bones placed between the basibranchial and the ceratobranchial series. The anteriormost (first) hypobranchial is the largest of the three, and somewhat elongated rectangular in general form. This bone articulates to the second basibranchial proximally, and to the first ceratobranchial distally. This bone is possessed of a lateral process on the lateral margin where it is connected with the anterodorsal face of the ceratohyal by a ligamentous tissue. The second hypobranchial is somewhat roundish triangular bone. This bone articulates to the interspace cartilage between the second and third basibranchial proximally, and to the second ceratobranchial distally. The third

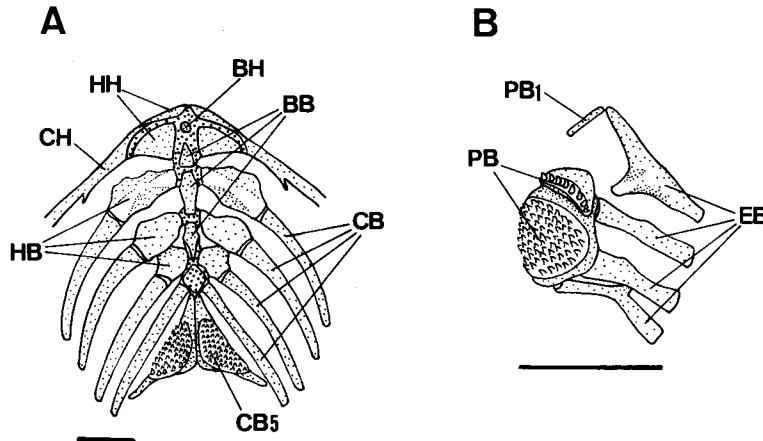

Fig. 22. Branchial apparatus in *Jordania zonope*. A, oral surface of branchial and hyoid apparatus (epibranchials and pharyngobranchials are removed); B, oral surface of epibranchials and pharyngobranchials. BB, basibranchial; BH, basihyal; CB, ceratobranchial; CH, ceratohyal; EB, epibranchial; HB, hypobranchial; HH, hypohyal; PB, pharyngobranchial. Scales indicate 2 mm.

hypobranchial is triangular bone slightly elongated anteriorly. This bone articulated to the central cartilage proximally, and to the third ceratobranchial distally. Anterior tip of this bone gets under the second hypobranchial and forms the descending process to which the rectus ventralis from the urohyal inserts when it is present.

Ceratobranchial (CB): The ceratobranchials are five paired bones. Anterior four (first to fourth) are elongated and slightly curved bones and bear gill rakers on inner surface and gill filaments on the outer surface. The first to third ceratobranchials articulate respectively to the first to third hypobranchials proximally, and to the first to third epibranchials distally. The fourth ceratobranchial articulates to the central cartilage proximally and to the fourth epibranchial distally. The posterior-most (fifth) ceratobranchial is a stout triangular bone bearing a tooth plate dorsally. At anteromedial margin the fifth ceratobranchial is connected with its antimeres on the median line through the cartilaginous interposition. This bone attaches to the fourth ceratobranchial distally.

Epibranchial (EB): The epibranchials are four pairs of rod-shaped bones. The anteriormost (first) epibranchial is branched distally to form two articular heads. The anterior head articulates to the first pharyngobranchial in *Jordania*, *Ereunias*, *Marukawichthys* and *Rhamphocottus*, while it is connected with the parasphenoid or the prootic through a thin ligament in the other cottoid fishes which do not have the first pharyngobranchial. The posterior head is connected with the second or third (when the second is absent) pharyngobranchial by a strong ligament. The second to fourth epibranchials articulate to the third pharyngobranchial by interposition of cartilages. The third and fourth epibranchials have low articular processes on the dorsal surface where these bones are articulated each other. In *Hemitripteris villosus*, there is a small tooth plate on oral surface of the third epibranchial (Fig. 23, A).

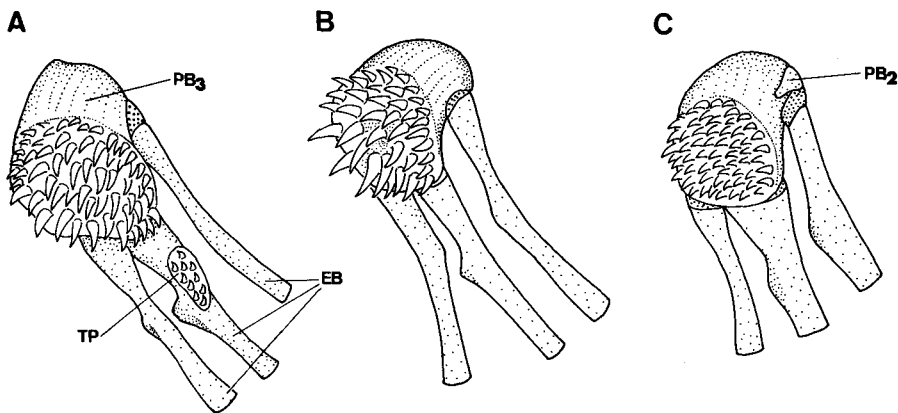

Fig. 23. Oral surface of epibranchials and pharyngobranchials (the first epibranchial is removed). A, *Hemitripteris villosus*; B, *Hemitripteris bolini*; C, *Blepsias cirrhosus*. EB, epibranchial; PB, pharyngobranchial; TP, tooth plate on the third epibranchial. Scales indicate 5 mm.

Pharyngobranchial (PB): The pharyngobranchials are the uppermost elements of the branchial apparatus and form the dorsal wall of the pharyngeal region. In the cottoid fishes examined, the condition of this bone is classified into four morphotypes by the numbers of the elements and tooth plates. Type A includes the fishes of the genera *Rhamphocottus*, *Ereunias*, *Marukawichthys* and *Jordania*. In this type, three pharyngobranchials and two tooth plates are present (Fig. 28, B). The first bone (suspensory pharyngobranchial) is a small and rod-shaped bone. This bone articulates to the first epibranchial proximally and is connected with the parasphenoid or the prootic distally. The second pharyngobranchial is a stout and somewhat roundish bone and closely united on the ventral surface of the third pharyngobranchial. On the anterior margin this bone has a small ascending process whose distal tip is cartilaginous. The ligament coming from the first epibranchial attaches to this process. On the ventral surface, this bone possesses a tooth plate. The third pharyngobranchial is the largest of the three and bearing a tooth plate on the ventral surface. The third pharyngobranchial articulates to the second to the fourth epibranchials. Type B includes the fishes of the genera *Alcichthys*, *Artdiel-lus*, *Artdiellichthys*, *Artdius*, *Asemichthys*, *Ascelichthys*, *Chitonotus*, *Clinocottus*, *Cottiusculus*, *Cottus*, *Gymnocanthus*, *Hemilepidotus*, *Leiocottus*, *Leptocottus*, *Oligocottus*, *Orthonopias*, *Radulinus*, *Scorpaenichthys*, *Taurocottus*, *Trichocottus*, *Trachidermus*, *Triglops* and *Zesticelus*. In this type, the first pharyngobranchial is absent, but the second and the third bone and their tooth plates are present (Fig. 28, C). Type C includes the fishes of the genera *Blepsias* and *Bero*. In this type, the second and the third pharyngobranchials are present. The tooth plate is present on the third bone, but it is absent on the second (Fig. 28, D). Type D includes the fishes of the families Agonidae, Psychrolutidae and the cottid genera *Argyrocottus*, *Enophrys*, *Microcottus*, *Myoxocephalus*, *Porocottus*, *Taurulus*, *Stelgistrum*, *Synchirus*, *Icelus*, *Icelinus*, *Ricuzenius*, *Furcina*, *Ocynectes*, *Pseudoblennius*, *Vellitor* and *Stlen-gis*. In this type, only the third pharyngobranchial and its tooth plate are present (Fig. 28, E).

Discussion. The branchial apparatus of the cottoid fishes has been examined by several investigators (Girard, 1852; Johnson, 1918; Taranetz, 1941; Quast, 1965; Yabe, 1981, 1983). In these studies, the number of the tooth plates on the pharyngobranchials has attracted most of their attentions. Among the cottoid fishes examined here, the differences are found in the number of pharyngobranchials and their tooth plates, and the presence or absence of the tooth plate on the third

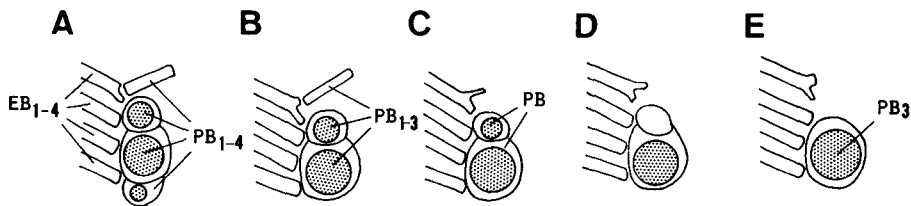

Fig. 24. Four types of the pharyngobranchials and their tooth plates in the cottoid fishes. A, generalized percoid type; B, type A of the cottoid fishes; C, type B of the cottoid fishes; D, type C of the cottoid fishes; E, type D of the cottoid fishes. For abbreviations, see Fig. 23.

Table 5. Comparison of three characters of the branchial arch in the cottoid fishes. SP, suspensory pharyngeal; PHB, number of the pharyngo-branchials and their tooth plates; EBT, tooth plate on the third epibranchial. P, primitive condition; D, derived condition (D1 < D2).

Morphotype	Character				Family and genus	
	SP		PHB			
I	present	P				Rhamphocottidae; <i>Rhamphocottus</i> Ereuniidae; <i>Ereunias</i> , <i>Marukawichthys</i> Cottidae; <i>Jordania</i>
II			two bones with two tooth plates	P		Cottidae; <i>Scorpaenichthys</i> , <i>Hemilepidotus</i> , <i>Leptocottus</i> , <i>Cottus</i> , <i>Trachidermus</i> , <i>Artedius</i> , <i>Chitonotus</i> , <i>Orthonopias</i> , <i>Triglops</i> , <i>Radulinus</i> , <i>Asemichthys</i> , <i>Astrocottus</i> , <i>Oligocottus</i> , <i>Clinocottus</i> , <i>Leiocottus</i> , <i>Gymnocanthus</i> , <i>Artediellus</i> , <i>Cottiusculus</i> , <i>Artediellichthys</i> , <i>Zesticelus</i> , <i>Taurocottus</i> , <i>Trichocottus</i> , <i>Alcichthys</i> , <i>Ascelichthys</i>
III			two bones with one tooth plate	D1	absent	D Hemitripteridae; <i>Blepsias</i> Cottidae; <i>Bero</i>
IV	absent	D	one bone with one tooth plate	D2		Hemitripteridae; <i>Hemitripterus bolini</i> , <i>Nautichthys</i> Agonidae; <i>Agonomalus</i> , <i>Podothecus</i> , <i>Tilesina</i> Cottidae; <i>Icelus</i> , <i>Ricuzenius</i> , <i>Stelgistrum</i> , <i>Thyriscus</i> , <i>Icelinus</i> , <i>Stilengis</i> , <i>Synchirus</i> , <i>Myoxocephalus</i> , <i>Porocottus</i> , <i>Microcottus</i> , <i>Argyrocottus</i> , <i>Enophrys</i> , <i>Taurulus</i> , <i>Ocynectes</i> , <i>Furcina</i> , <i>Pseudoblennius</i> , <i>Vellitor</i> Psychrolutidae; <i>Dasycottus</i> , <i>Eurymen</i> , <i>Ebinania</i> , <i>Cottunculus</i> , <i>Malacocottus</i> , <i>Neophrynichthys</i> , <i>Psychrolutes</i>
V					present	P Hemitripteridae; <i>Hemitripterus villosus</i>

epibranchial.

Number of the pharyngobranchials and their tooth plates: Among cottoid fishes examined, there are four types on this character as described above. Type A has three pharyngobranchials and two tooth plates. Type B has two pharyngobranchials and two tooth plates. Type C has two bones and a tooth plate. Type D has a bone and a tooth plate. In the generalized percoid fishes, the typical condition of this character has four pharyngobranchials and three tooth plates (Nelson, 1969; Liem, 1970; Johnson, 1980). In this condition, the first pharyngobranchial is a rod-like bone, while the second to the fourth are somewhat stout bones with tooth plates on the ventral surface (Fig. 24, A). The third pharyngobranchial is larger than the second and the fourth, and articulates to the second to the fourth epibranchials. The fourth bone is closely united with the posterior margin of the third. It is considered that type A of the cottoid fishes could be easily derived from the percoid condition, if the fourth bone is lost or fused with the third. It, therefore, is defined that type A is the most primitive condition, and type D is the most derived condition in the cottoid fishes. Among the other scorpaeniform fishes examined here, the condition of the pharyngobranchials in the scorpaenid, platycephalid, triglid, anoplopomatid, hexagrammid, and zaniolepidid fishes is as same as that of the generalized percoid fishes. On the other hand, the cyclopterid and the liparidid representatives are possessed of the pharyngobranchial elements as same as the type D in the cottoid fishes.

Tooth plate on the third epibranchial: Among the cottoid fishes examined, only *Hemitripterus villosus* possesses a tooth plate on the third epibranchial. The tooth plate is absent in the other cottoid fishes. In the generalized percoid fishes, a tooth plate is present on the second and third epibranchials (Nelson, 1969; Johnson, 1980). It, therefore, is considered that the presence of tooth plate on the third epibranchial is the primitive condition in the cottoid fishes.

Among other scorpaeniform fishes examined, the tooth plate on the third epibranchial is present in the scorpaenid, triglid and platycephalid fishes, while it is absent in hexagrammid, zaniolepidid, anoplopomatid, cyclopterid and liparidid fishes.

On the basis of the conditions of the branchial apparatus, the cottoid fishes are classified into five morphotypes summarized in Table 5.

7. PECTORAL GIRDLE AND FIN RAYA (Figs. 25 and 26; Table 6)

Description. The pectoral girdle is composed of seven elements; the posttemporal, the supratemporal, the cleithrum, the scapula, the coracoid, the actinost and the postcleithrum. The supratemporal is described and discussed in the section of the cranium.

Posttemporal (PT): The posttemporal is a V-shaped bone and usually widely forked anteriorly to form the anterodorsal process and the anteroventral process. The anterodorsal process of this bone is a long and flat process, and articulates with the dorsal facet of the epiotic. The anteroventral process of this bone is a rod-like shaped process, and is ligamentously connected with the intercalar. In the fishes of the families Agonidae and Rhamphocottidae, the posttemporal is not forked anteriorly and present as a triangular bone. The posttemporal is attached to the anterior

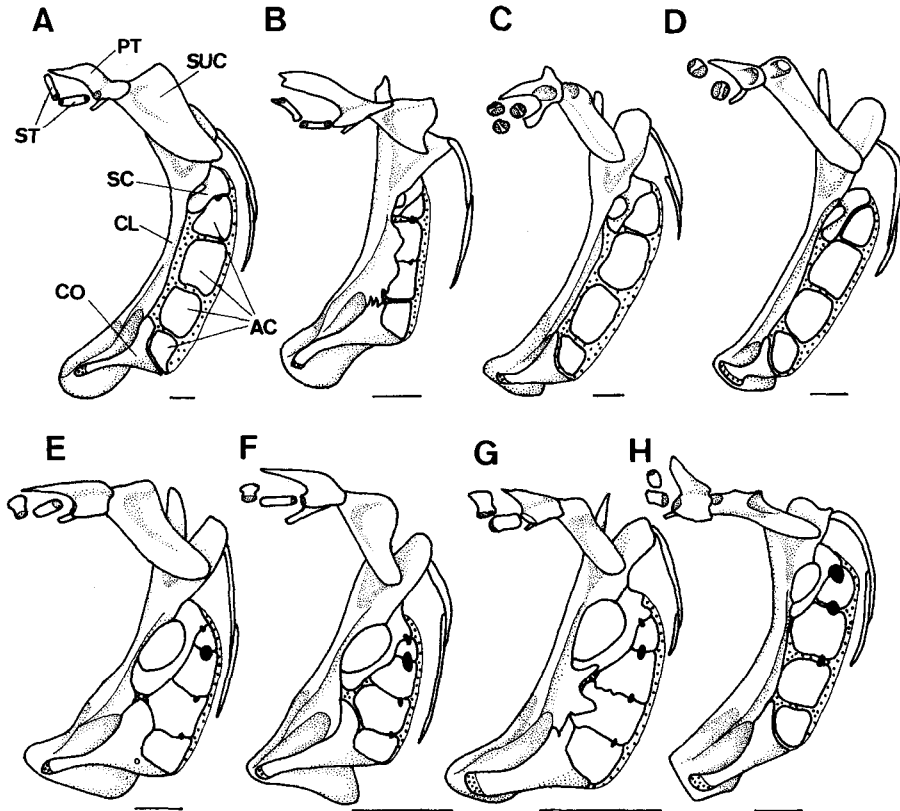

Fig. 25. Lateral aspects of the pectoral girdle in 8 cottoid fishes. A, *Hemitripterus villosus*; B, *Blepsias cirrhosus*; C, *Dasycottus setiger*; D, *Malacocottus gibber*; E, *Pseudoblennius percoides*; F, *Vellitor centropomus*; G, *Oligocottus maculosus*; H, *Gymnocanthus herzensteini*. AC, actinost; CO, coracoid; CL, cleithrum; PT, posttemporal; SC, scapula; SUC, supracleithrum. Scales indicate 5 mm.

tip of the supracleithrum posteriorly. The sensory canal of the supratemporal runs into the lateral line through the posttemporal and the supracleithrum.

Supracleithrum (SUC): The supracleithrum is triangular and laminal in general form. On the dorsal margin, this bone possesses a tubular structure where the sensory canal passes. This bone is attached to the posttemporal anteriorly, and to the cleithrum posteromedially. The Baudelot's ligament attaches to the medial surface of this bone.

Cleithrum (CL): The cleithrum is the largest bone in this region. This bone is slightly curved anteromedially. The dorsal part of this bone is flattened with a large notch where the Baudelot's ligament passes. On this region the cleithrum is ligamentously connected with the supracleithrum laterally and is attached to the postcleithrum posteriorly. On the middle part of this bone, there is a developed lateral wing. The posterior surface of this wing is broadly inserted by the muscles of the abductor series of pectoral fin. On the anteroventral face of this wing, there

is a shallow fossa where the muscular fibers of the sternohyoidius and pharyngo-clavicularis insert. On this region the cleithrum is firmly connected with the scapula posterodorsally, and with the dorsal arm of the coracoid. The posterior lamina of the cleithrum usually overlies on parts of the scapula and the coracoid. On the ventral part, the cleithrum is flattened to form the cleithrum foot. The cleithrum foot is firmly connected with its antimere on the anteroventral margin, and with the ventral arm of the coracoid through a cartilaginous interval ventrolaterally. On the medial surface of this region the cleithrum articulates to the anterolateral surface of the pelvis.

Scapula (SC): The scapula is quadrangular or rhombic in general shape. This bone attaches to the cleithrum anteriorly. In the most cottoid fishes, this bone supports upper two actinosts posteriorly, while it supports the uppermost actinost in the hemitripterid and psychrolutid fishes. In the most of cottoid fishes, a large foramen is present between the cleithrum and this bone, and the branch of the ramus lateralis accessorius nerve passes through the foramen. In the fishes belonging to the genera *Jordania* and *Rhamphocottus*, the scapula foramen is placed on the scapula, but the crack is present on the anterior part of this bone.

Coracoid (CO): The coracoid is falciform in general shape. This bone is connected with the cleithrum by two arms. Anterodorsally it firmly attaches to posterior margin of the cleithrum. Anteroventrally this bone extends lower forward and attaches to the cleithrum foot through the cartilaginous interval. This bone is separated from the scapula by the cartilaginous interval. This bone supports lower two actinosts in the most of the cottoid fishes, while it supports only the lowermost one in *Hemitripterus*, *Blepsias*, *Arteidiellus*, *Arteidiellichthys*, *Cottiusculus* and *Zesticelus* and the family Psychrolutidae.

Actinost (AC): Actinosts are thin and quadrangular in general shape, and lie between the scapula and the coracoid. In the cottoid fishes examined here except for *Scorpaenichthys*, four actinosts are present. In *Scorpaenichthys marmoratus*, there are three actinosts. In the most of the cottoid fishes examined, there are a few small pores between each actinost, while such a pore is absent in the psychrolutid fishes.

Postcleithrum: The postcleithrum is slender and slightly curved. Most of the cottoid fishes examined have two postcleithra. The fishes of the genera *Cottunculus*, *Eurymen* and *Nautichthys* have a small postcleithrum. There is no element of this bone in *Ascelichthys*, *Clinocottus* and *Synchirus*.

Pectoral fin: In the ereuniid fishes, lower four rays are free from the upper part. In the *Synchirus gilli*, the pectoral fin is united to its antimere on the breast. These conditions are not observed in the other cottoid fishes.

Discussion. The pectoral girdle of the cottoid fishes has been examined by several authors (Girard, 1852; Gill, 1889; Regan, 1913; Johnson, 1918; Starks, 1930; Rendahl, 1934; Matsubara, 1936; Taranetz, 1941; Watanabe, 1958; Yabe, 1981, 1983). In these studies, the distance between the scapula and the coracoid, and the number of the actinosts have been remarked. Among the cottoid fishes examined, the differences are found in the following six characters; the condition of the scapula foramen, the relation between the scapula and the coracoid, the number of the actinosts, the presence or absence of the pores between each actinost, the presence or absence of the free pectoral rays, the presence or absence of the con-

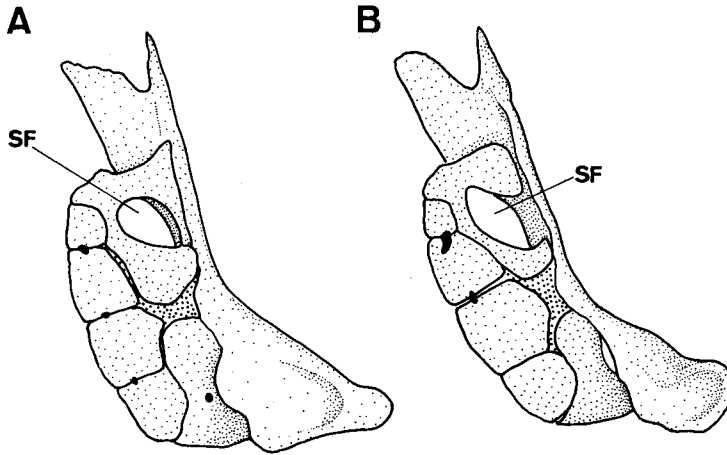

Fig. 26. Medial aspects of the pectoral girdle. A, *Jordania zonope*; B, *Bero elegans*. SF, scapula foramen. Scales indicate 2 mm.

tinuous pectoral fin.

Condition of the scapula foramen: Among the cottoid fishes examined here, there are two types on this character. Type A has the scapula foramen closed on the scapula. There is a crack on the anterior part of the scapula (Fig. 26, A). Type B is the condition that the scapula foramen is opened against the cleithrum (Fig. 26, B). In the generalized percoid fishes, the scapula foramen is completely closed, and the crack is absent (Starks, 1930; Rendahl, 1934; Katayama, 1959; Gosline, 1966). This condition is similar to type A in the cottoid fishes. It is considered that type A of this character is the primitive condition in the cottoid fishes, and that type A is more derived than the condition of the generalized percoid fishes because the crack is absent in the percoid type. Among the other scorpaeniform fishes, the scapula foramen is present on the scapula in the scorpaenoid, platycephalid, hexagrammid, zaniolepidid, anoplopomatid representatives (Regan, 1913; Starks, 1930; Rendahl, 1934; Matsubara, 1943; Matsubara and Ochiai, 1955) But this foramen is opened against the cleithrum in the hoplichthyid and triglid fishes (Regan, 1913; Starks, 1930; Rendahl, 1934). In the cyclopterid and the liparidid fishes, the foramen is very reduced and present as a narrow slit between the scapula and the cleithrum, or absent (Starks, 1930; Ueno, 1970).

Relation between the scapula and the coracoid: In the cottoid fishes, the width between the scapula and the coracoid is gradually changed. Many investigators have remarked this character (Gill, 1889; Regan, 1913; Taranetz, 1941; Matsubara, 1943; Quast, 1965). Regan (1913) regarded this character as a difference between his families Cottidae and Psychrolutidae-Cottunculidae. Taranetz (1941) considered that the width between both bones could be widened to accompany the loss of mobility in the cottoid fishes. Among the cottoid fishes examined here, the condition of this character is changed successively, and can not be classified into any distinct morphotypes. But, the scapula is always separated from the coracoid in all

cottoid fishes. This condition has not been reported from the generalized percoid fishes which have the scapula attaching or closely approaching to the coracoid (Starks, 1930; Katayama, 1959; Gosline, 1966). Thus, it is considered that the condition having the scapula separated from the coracoid is the derived condition shared by all cottoid fishes. Among other scorpaeniform fishes, the percoid type of this character has been observed in the scorpaenoid, platycephalid, zaniolepidid, anoplopomatid fishes (Regan, 1913; Starks, 1930; Rendahl, 1934; Matsubara, 1943, Quast, 1965). In the hexagrammid and triglid fishes, the condition of the cottoid fishes has been observed (Starks, 1930, Rendahl, 1934; Quast, 1965). In the cyclopterid and the liparidid fishes, the scapula is far apart from the coracoid (Ueno, 1970).

Number of actinosts: Most of the cottoid fishes have four actinosts, while only a species *Scorpaenichthys marmoratus* has three actinosts. The condition of the *Scorpaenichthys* has been described by Starks (1930). Taranetz (1941) remarked this character and considered that *Scorpaenichthys* was not included in the cottoid fishes, and "trend more toward the antarctic Nototheniformes". It is considered that the condition in *Scorpaenichthys* is derived condition in the cottoid fishes, because the generalized percoid fishes have four actinosts (Starks, 1930; Katayama, 1959; Gosline, 1966). It is considered that the condition of *Scorpaenichthys* could be occur by the fusion between the scapula and the uppermost actinost. Among other scorpaeniform fishes, it has been clarified that the uppermost actinost is often fused to the scapula in the scorpaenid fishes (Starks, 1930; Matsubara, 1943). The other scorpaeniform fishes examined here are possessed of four actinosts.

Pores between each actinost: In the most of cottoid fishes examined, there are one to four small pores between each actinosts. Number and size of these pores are variable within species. But it is always absent in the psychrolutid fishes. In the generalized percoid fishes, there are wide spaces between each actinost. Therefore it is considered that the condition possessing pores between each actinost is the primitive condition in the cottoid fishes. These pores have been observed in the scorpaenoid, triglid, platycephalid, anoplopomatid, zaniolepidid, hexagrammid and cyclopterid fishes (Starks, 1930; Rendahl, 1934; Matsubara, 1943; Quast, 1965; Ueno, 1970).

Free pectoral fin rays: In the ereuniid fishes examined, the lower four fin rays are free from the upper lobe of the pectoral fin. This condition is not observed in the other cottoid fishes. In the generalized percoid fishes, the free pectoral fin rays are absent. Therefore, the condition observed in the ereuniid fishes is the derived condition in the cottoid fishes. Among the scorpaeniform fishes, the triglid fishes have three free pectoral fin rays, and the peristidid fishes have two free pectoral fin rays. In these two groups the muscular condition of the pectoral fin is remarkably modified (described in the myological section).

Continuous pectoral fin: Among the cottoid fishes examined here, *Synchirus gilli* has the pectoral fin which attaches to its antimere on breast. This condition is not observed in the cottoid fishes examined as well as the scorpaeniform and generalized percoid fishes. Thus it is considered that the condition observed in *Synchirus gilli* is the unique and derived condition in the cottoid fishes.

On the basis of the conditions of the pectoral girdle and fin rays, the cottoid

Table 6. Comparison of five characters of the pectoral girdle in the cottoid fishes. SCF, scapula foramen; FPR, free pectoral rays; PAC, pores between each actinost; PCF, condition that the pectoral fin is attached to its antimeres on the ventral midline; NAC, number of actinosts. P, primitive condition; D, derived condition.

Morphotype	Character					Family and genus					
	SCF		FPR		PAC		PCF	NAC			
I	close	P	absent	P				Rhamphocottidae; <i>Rhamphocottus</i> Cottidae; <i>Jordania</i>			
II			present	D				Ereuniidae; <i>Marukawichthys</i> , <i>Ereunias</i>			
III	open	D	absent	P	present	P	absent	P	4	P	Agonidae; <i>Agonomalus</i> , <i>Podothecus</i> , <i>Tilesina</i> Hemitripteridae; <i>Hemiteripterus</i> , <i>Blepsias</i> , <i>Nautichthys</i> Cottidae; <i>Hemilepidotus</i> , <i>Leptocottus</i> , <i>Trachidermus</i> , <i>Cottus</i> , <i>Artedius</i> , <i>Chitonotus</i> , <i>Orthonopias</i> , <i>Triglops</i> , <i>Radulinus</i> , <i>Asemichthys</i> , <i>Astrocottus</i> , <i>Icelus</i> , <i>Ricuzenius</i> , <i>Stelgistrum</i> , <i>Thyriscus</i> , <i>Stlengis</i> , <i>Icelinus</i> , <i>Oligocottus</i> , <i>Clinocottus</i> , <i>Leiocottus</i> , <i>Ascelichthys</i> , <i>Taurocottus</i> , <i>Trichocottus</i> , <i>Artediellus</i> , <i>Artediellichthys</i> , <i>Cottiusculuc</i> , <i>Zesticelus</i> , <i>Myoxocephalus</i> , <i>Microcottus</i> , <i>Porocottus</i> , <i>Argyrocottus</i> , <i>Enophrys</i> , <i>Taurulus</i> , <i>Alcichthys</i> , <i>Bero</i> , <i>Ocynectes</i> , <i>Furcina</i> , <i>Vellitor</i> , <i>Pseudoblennius</i>
IV									3	D	Cottidae; <i>Scorpaenichthys</i>
V							present	D			Cottidae; <i>Synchirus</i>
VI					absent	D	absent	P	4	P	Psychrolutidae; <i>Dasycottus</i> , <i>Eurymen</i> , <i>Ebinania</i> , <i>Cottunculus</i> , <i>Malacocottus</i> , <i>Neophrynichthys</i> , <i>Psychrolutes</i>

fishes are classified into six morphotypes summarized in Table 6.

8. PELVIC GIRDLE AND FIN RAYS (Figs. 27 and 28; Table 7)

Description. The pelvic fin is supported by a pair of the pelvis.

Pelvis (PV): The pelvis is a triangular or quadrangular and stout bone in general form. This bone is sutured with its antimere on the ventral midline with a median gap. It forms the suprapelvic keel (SPK) dorsolaterally and the subpelvic keel (SBK) ventrolaterally. This bone has one articular facet anterolaterally where it articulates with the ventromedial surface of the cleithrum. The pelvis has the subpelvic process (SBP) which is situated on the ventral midline just posterior to median gap, and projects forward. This process is developed in the most of the cottoid fishes, but it is rather short in the hemitripterids, and it is obscure in the agonid fishes. The postpelvic process (POP) is situated on the posteromedian tip of the pelvis. This process is normally developed in the ereuniid and cottoid fishes, but it is blunt in the other cottoid fishes. In *Rhamphocottus richardsoni*, the pelvis is greatly modified in comparison with that of the other cottoid fishes; the subpelvic keel is well developed to project forward, and the suprapelvic keel extends anterodorsally (Fig. 28).

Pelvic fin rays: Among the cottoid fishes examined here, the number of the pelvic fin rays is remarkably changed. The psychrolutid, hemitripterid and rhamphocottid fishes have one spine and three soft rays on the pelvic fin. The agonid fishes have one spine and two soft rays. Among the ereuniid fishes, the genus

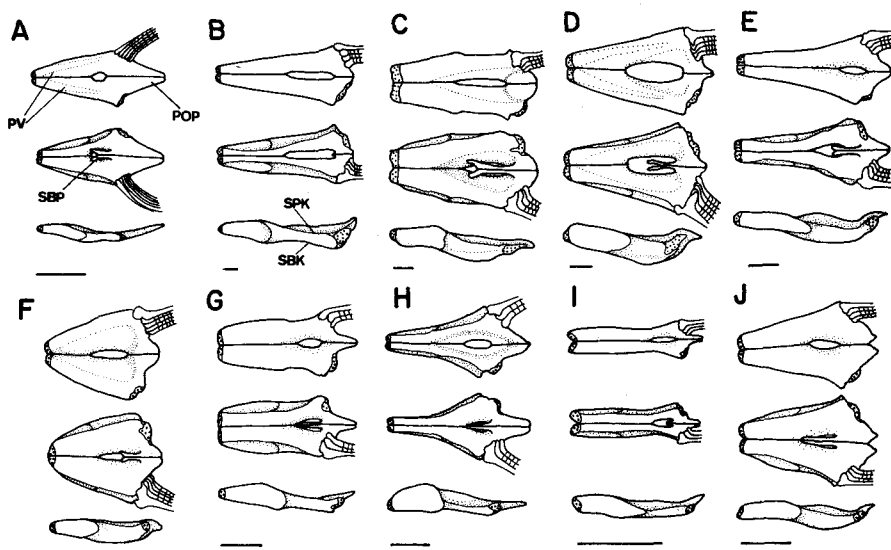

Fig. 27. Dorsal (above), ventral (middle) and lateral (below) aspects of the pelvic girdle in 10 cottoid fishes. A, *Marukawichthys ambulator*; B, *Hemitripterus villosus*; C, *Eurymen gyrinus*; D, *Hemilepidotus gilberti*; E, *Ricuzenius toyamensis*; F, *Cottus pollux*; G, *Bero elegans*; H, *Ocynectes maschalis*; I, *Furcina oshimai*; J, *Artediellus dydymovi*. POP, postpelvic process; PV, pelvis; SBK, subpelvic keel; SBP, subpelvic process; SPK, suprapelvic keel. Scales indicate 2 mm.

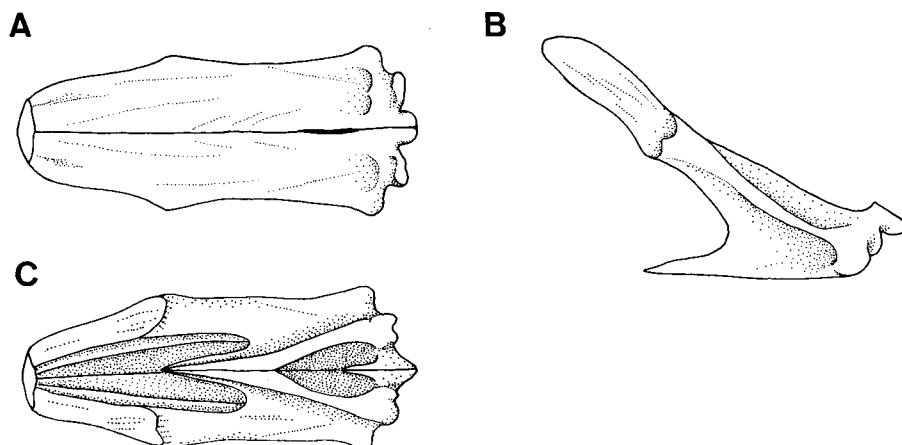

Fig. 28. Pelvis in *Rhamphocottus richardsoni*. A, medial aspect; B, lateral aspect; C, ventral aspect. Scale indicates 5 mm.

Marukawichthys has one spine and four soft rays, while the genus *Ereunias* has no pelvic fin element or only a vestigial spine under the skin. In the cottid fishes, the number of the pelvic fin is changed from one spine and five soft ray to no fin element. The number of the pelvic fin rays in each cottoid fishes is shown in Table 7.

Discussion. The pelvic girdle of the cottoid fishes has been described by Girard (1852), Johnson (1918), Taliev (1955), Watanabe (1958) and Yabe (1981). The number of the pelvic fin rays has been regarded as the important character for the identification and evolutionary consideration in the cottoid fishes (Tarantetz, 1941; Bolin, 1947; Watanabe, 1958; Quast, 1965; Yabe, 1981). In the present study, the distinct differences within the cottoid fishes are found in the general form of the pelvis and the number of pelvic fin rays.

General form of the pelvis: The general form of the pelvis is changed in the cottoid fishes. Watanabe (1958) attended to this character and classified the Japanese cottoid fishes into eight morphotypes. In the present study, it is clarified that there are many intermediate conditions between each morphotype defined by Watanabe (1958). But *Rhamphocottus richardsoni* has an unique pelvic girdle which is distinctly different from that of other cottoid fishes. This condition is characterized by having remarkably developed subpelvic keel and the suprapelvic keel (Fig. 28), and unique distribution of the pelvic muscles described in the myological section (Fig. 46). This condition has not been reported from the generalized percid fishes. It, therefore, is considered the condition found in *Rhamphocottus* is the unique and derived among the cottoid fishes.

Number of the pelvic fin rays: The number of the pelvic fin rays is remarkably changed within the cottoid fishes in comparison with that of the other fish groups. Its number is changed from 0 to one spine and five soft rays as summarized in Table 7. This character has been regarded as the important for identification of the cottoid fishes (Jordan and Evermann, 1898; Jordan and Starks, 1904; Tarantetz,

Table 7. Comparison of two characters of the pelvic girdle in the cottoid fishes. NFR, number of pelvic fin rays; GFP; general form of the pelvis. P, primitive conditios; D, derived condition (D1 < D2 < D3.....).

Morphotype	Character				Family and genus
	NFR	GFP			
I	I, 5	P	normal	P	Cottidae; <i>Jordania</i> , <i>Scorpaenichthys</i>
II	I, 4	D1			Ereuniidae; <i>Marukawichthys</i> Cottidae; <i>Hemilepidotus</i> , <i>Leptocottus</i> , <i>Trachidermus</i> , <i>Cottus</i>
III	I, 3	D2	unique	D	Rhamphocottidae; <i>Rhamphocottus</i>
IV			normal	P	Hemitripterae; <i>Hemitripterus</i> , <i>Blepsias</i> , <i>Nautichthys</i> Cottidae; <i>Arteidius</i> , <i>Chitonotus</i> , <i>Orthonopias</i> , <i>Triglops</i> , <i>Radulinus</i> , <i>Asemichthys</i> , <i>Astrocottus</i> , <i>Icelus</i> , <i>Ricuzenius</i> , <i>Stelgistrum</i> , <i>Thyriscus</i> , <i>Oligocottus</i> , <i>Clinocottus</i> , <i>Leiocottus</i> , <i>Synchirus</i> , <i>Gymnocanthus</i> , <i>Artediellus</i> , <i>Cottiusculus</i> , <i>Artediellichthys</i> , <i>Taurocottus</i> , <i>Trichocottus</i> , <i>Myoxocephalus</i> , <i>Microcottus</i> , <i>Porocottus</i> , <i>Argyrocottus</i> , <i>Enophrys</i> , <i>Taurulus</i> Psychrolutidae; <i>Dasycottus</i> , <i>Eurymen</i> , <i>Ebinania</i> , <i>Cottunculus</i> , <i>Neophrynichthys</i> , <i>Psychrolutes</i>
V			I, 2	D3	Agonidae; <i>Agonomalus</i> , <i>Podothecus</i> , <i>Tilesina</i> Cottidae; <i>Icelinus</i> , <i>Stlengis</i> , <i>Zesticelus</i> , <i>Alcichthys</i> , <i>Bero</i> , <i>Ocynectes</i> , <i>Furcina</i> , <i>Pseudoblennius</i> , <i>Vellitor</i>
VI	I or 0	D4			Ereuniidae; <i>Ereunias</i> Cottidae; <i>Ascelichthys</i>

1941; Bolin, 1944; Matsubara, 1955; Watanabe, 1958). Bolin (1947) considered that the hypothetical cottoid ancestor may be similar to the primitive scorpaenids which have one spine and five soft rays on the pelvic fin. On the other hand, Watanabe (1958) considered that the condition having one spine and three soft rays which is common type in the Japanese cottoid fishes is the basic pattern. In the present study, it is regarded that the pelvic fin having one spine and five soft rays is the most primitive condition in the cottoid fishes, because the all generalized percoid have this condition. It is considered that progressive reduction of fin ray elements may be occurred from this primitive condition through the evolutionary process of the cottoid fishes.

Among the other scorpaeniform fishes, the pelvic fin is composed of one spine and five soft rays in the most of the scorpaenoid fishes, and platycephalid, hexagrammid, zaniolepidid and anoplomatid fishes. The most of the cyclopterid and the liparidid fishes have the pelvic disk. It has been reported that the pelvic disk is composed of six or less fin ray elements (Ueno, 1970; Stein, 1978).

On the basis of the conditions of the pelvic girdle and fin rays, the cottoid fishes are classified into six morphotypes summerized in Table 7.

9. POSTCRANIAL AXIAL SKELETON centrum.

Description. (Figs. 29 and 30)

Vertebrae: The vertebrae are divided into two parts; the abdominal vertebrae (AV) and the caudal vertebrae (CV). The abdominal vertebrae are characterized by the absence of the haemal spines. The typical abdominal vertebra is possessed of the neural arch and the neural spine (NS). A pair of the neural prezygapophyses (NPZ) is present on the anterodorsal tip of neural arch, and a pair of the neural postzygapophyses (NOZ) is present on the posterodorsal tip of the centrum. The haemal prezygapophysis and postzygapophysis are not developed in the abdominal vertebrae. The centra of anterior some abdominal vertebrae are shorter than those following. The first abdominal vertebra is modified to form three articular facet anteriorly; one of them is articulated to the basioccipital, and the others are to the exoccipitals of both sides. This bone has the neural arch which is not fused with the opposite member dorsally, and does not have the neural spine. Posterior abdominal vertebrae have a pair of parapophyses (PAP) situated on the anteroventral sides of the centrum. In the posterior some abdominal vertebrae, the parapophysis is fused with its opposite member and forms the haemal arch (HA). The caudal vertebrae are characterized by having the haemal spines (HS). All haemal spines are fused with the centra. In the caudal vertebrae, the haemal prezygapophysis (HPZ) and the postzygapophysis (HOZ) are developed as well as the neural zygapophyses. In the last some vertebrae, the haemal postzygapophysis is fused with the haemal spine to form a small pore. In the ereuniid and some of cottid fishes, the lateral process is present on the lateral side of the posterior some caudal vertebrae.

Pleural ribs (PR): The pleural ribs are present on some posterior abdominal vertebrae in most of the cottoid fishes examined here. The number of the pleural ribs is two to eight (usually three to five). But this bone is absent in the agonid fishes *Podothecus* and *Tilesina*. The pleural ribs, when present, begin with sixth to

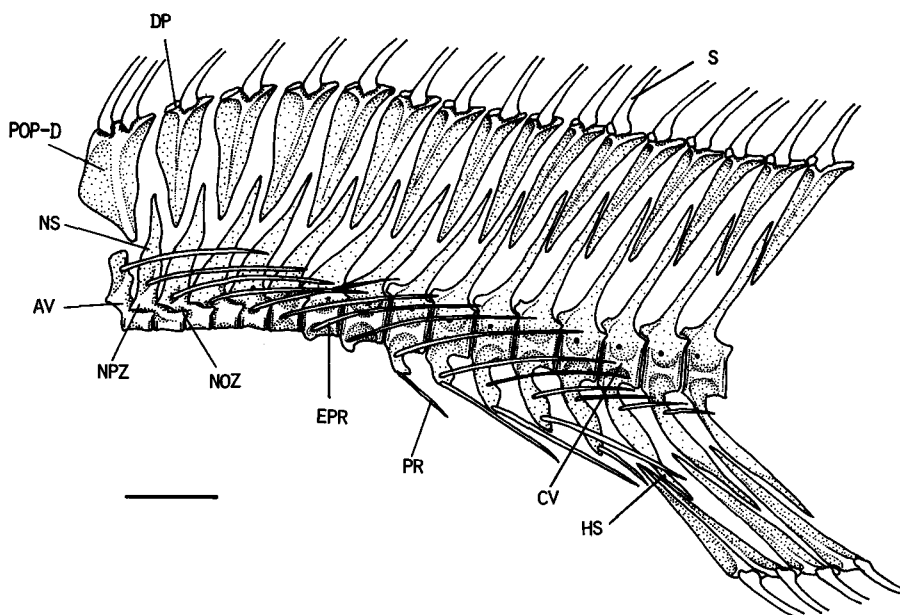

Fig. 29. Lateral view of anterior vertebrae and associated bones in *Hemilepidotus gilberti*. CV, first caudal vertebra; DP, distal pterygiophore; EPR, epipleural rib; HS, first haemal spine; NOZ, neural postzygapophysis; NPZ, neural prezygapophysis; NS, neural spine; PR, pleural rib; POP-D, proximal pterygiophore; R, dorsal ray; S, dorsal spine. Scale indicates 10 mm.

16th vertebrae (usually eighth to 11th) and end on ninth to 18th vertebrae (usually 11th to 13th). There is no pleural rib on the anterior five vertebrae in all cottoid fishes. The pleural rib is usually placed on the parapophysis, but a few anterior rudimentary ribs lie on the wall of the abdominal cavity.

Epipleural ribs (EPR): The epipleural ribs are present on the abdominal vertebrae and some of anterior caudal vertebrae. The first epipleural rib begins with the first vertebra. The epipleural ribs attach to the lateral surface of the centra.

Discussion. The vertebrae and associated bones have not been satisfactorily examined in the cottoid fishes. However, Regan (1913) and Quast (1965) mentioned the condition of the epipleural ribs and pleural ribs. Regan (1913) used the condition that both ribs attaches to the parapophysis as the diagnosis of hexagrammid-anoplopomatid fishes among the scorpaeniformes. Quast (1965) also observed this condition in hexagrammid, zaniolepidid, anoplopomatid and cottoid fishes, and considered that "the cottoid condition seems much more easily derivable from that of the hexagrammid, zaniolepidids and anoplopomatids, in which the two types of ribs originate on vertebrae, than from that of the scorpaenids". In the cottoid fishes examined here, the pleural and epipleural ribs attach to the parapophysis. In the generalized percoid fishes, it has been reported that the epipleural rib attaches to the pleural rib on each abdominal vertebra except for anterior two in

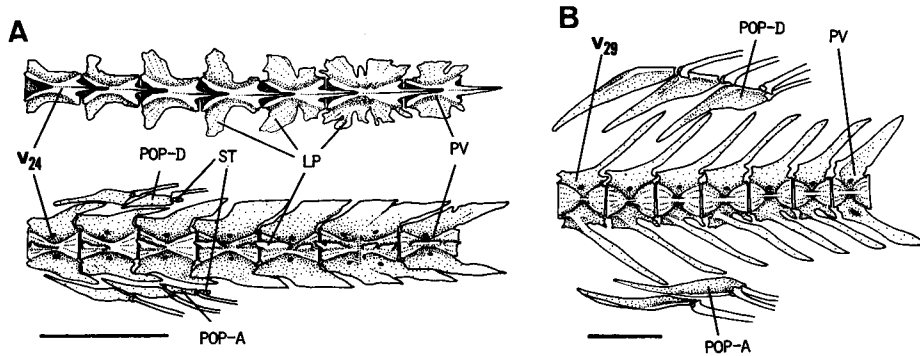

Fig. 30. Caudal vertebrae and associated bone. A, *Marukawichthys ambulator* (above, dorsal aspect; below, lateral aspect); B, *Hemilepidotus gilberti* (lateral aspect). LP, lateral process; POP-A, proximal pterygiophore of anal fin; POP-D, proximal pterygiophore of dorsal fin; PV, preural centrum; ST, stay; V, vertebrae. Scales indicate 5 mm.

which the pleural rib is absent (Stokely, 1952; Dineen and Stokely, 1956; Quast, 1965). Therefore it is considered that the condition that the pleural and epipleural ribs attach to the centrum is the derived condition, and it is the synapomorphy of the all cottoid fishes, hexagrammid, zaniolepidid, and anoplopomatid fishes. In regard to this character, it is considered that the assumption of Quast (1965) is adequate.

Among the cottoid fishes examined, the differences are found in the numbers of vertebrae, pleural and epipleural ribs, and condition of the lateral process of the caudal vertebrae. But these characters are remarkably varied within species. Thus they are not used for the phylogenetic consideration.

10. MEDIAN FIN SUPPORTS (Figs. 29-31; Table 8)

Description. The median fins are supported by three elements; the proximal pterygiophore, the distal pterygiophore and the stay. The medial pterygiophore is not observed in the cottoid fishes examined.

Proximal pterygiophore (POP): These bone are slender triangular in general form, and located between the neural spines on the dorsal series and between the haemal spines on the anal series. The first proximal pterygiophore of the dorsal series (POP-D) is placed between the first and the second vertebrae in the many cottoid fishes. It inserts before the first vertebra in the ereuniid fishes and the cottid fishes of the genera *Alcichthys*, *Bero*, *Chitonotus*, *Furcina*, *Pseudoblennius*, *Vellitor*, *Ocynectes*, *Icelinus*, *Scorpaenichtys*. In these fishes, the proximal pterygiophore is not found in the interspace between the first and the second vertebra. In *Hemitripterus villosus*, the first and the second proximal pterygiophores of the dorsal series are situated before the first vertebra. In two agonid genera *Tilesina* and *Podothecus*, the first proximal pterygiophore found in more posterior interspace than that of the other cottoid fishes. The first proximal pterygiophore of the dorsal series is situated between the fourth and the fifth vertebrae in *Podothecus*, and between the sixth and the seventh in *Tilesina*.

In the cottoid fishes examined, there is no predorsal proximal pterygiophore. The interdorsal pterygiophore, which is placed between the spinous and soft dorsal fins and does not support the fin ray element, is present in several cottoid fishes. The number of the interdorsal pterygiophores is instable in the cottoid fishes. Many cottoid fishes do not have the interdorsal pterygiophore. There is no or one interdorsal pterygiophore within the species of *Jordania zonope*, *Alcichthys alcicornis*, *Argyrocottus zanderi*, *Ocynectes maschalis*, *Taurocottus bergi*, *Triglops scepticus*, *Blepsias cirrhosus* and *Gymnocanthus* spp.. There is one interdorsal pterygiophore in all examined species of *Astrocottus*, *Leptocottus*, *Microcottus*, *Oligocottus*, *Silengis* and *Taurulus*. There is one or two interdorsal pterygiophores within a species of *Myoxocephalus polyacanthocephalus*, *Ereunias grillator* and *Hemitripteris bolini*. In the agonid fishes, there are two interdorsal pterygiophores in *Podotheucus*, and three in *Tilesina*.

The first pterygiophore of the dorsal series supports two dorsal spines in the most of cottoid fishes, while it supports one spine in the cottid genera *Cottus*, *Leptocottus*, *Trachidermus*, *Zesticelus*, and the psychrolutid genera *Cottunculus* and *Ebinania*. The last proximal pterygiophore of the dorsal series usually supports one fin ray in the many cottoid fishes, while it supports two rays in the fishes of the genera *Cottus*, *Hemilepidotus*, *Jordania* and *Scorpaenichthys*. The last pterygiophore of the anal series usually supports one fin ray in the cottoid fishes, while it supports two rays in the fishes of the genera *Cottus*, *Hemilepidotus*, *Jordania*, *Nautichthys*, *Rhamphocottus*, *Scorpaenichthys*, and *Hemitripteris*

Distal pterygiophore (DP): The distal pterygiophore is a small bone placed between each proximal pterygiophore and fin ray. This bone supporting the spiny ray is unpaired, while that supporting soft ray is paired bone. The distal pterygiophore placed on the first proximal pterygiophore of dorsal series is not observed.

Stay (ST): The stay is a small bone placed behind the last proximal pterygiophore of the dorsal and anal proximal pterygiophores. This bone is present in the fishes of the families Ereuniidae and Rhamphocottidae, while it is absent in the other cottoid fishes.

Discussion. The structure of the median fin supports in the cottoid fishes and the other scorpaeniform fishes have been described or discussed by some authors (Girard, 1852; Johnson, 1918; Matsubara, 1943; Quast, 1965; Ueno, 1970; Yabe, 1981, 1983). In the present study, the distinct differences within the cottoid fishes are found in the position of the anterior proximal pterygiophore of the dorsal series, the differences between the cottoid fishes and the percoid fishes are found in the anal series, and the presence or absence of the stay. In addition to these characters, the differences between the cottoid fishes and the percoid fishes are found in the conditions of the predorsal pterygiophore and the anal spines.

Position of the anterior proximal pterygiophore of dorsal series: On the basis of this character, the cottoid fishes are classified into five morphotypes. The first type, type A, includes many cottoid fishes in which the first pterygiophore inserts to the second interspace (between the first and the second vertebrae) (Fig. 31, A). Type B is the condition that the first proximal pterygiophore of the dorsal series is situated on the first interspace. The second interspace is not inserted by any pterygiophore (Fig. 31, B). Type C is the condition that anterior two pterygio-

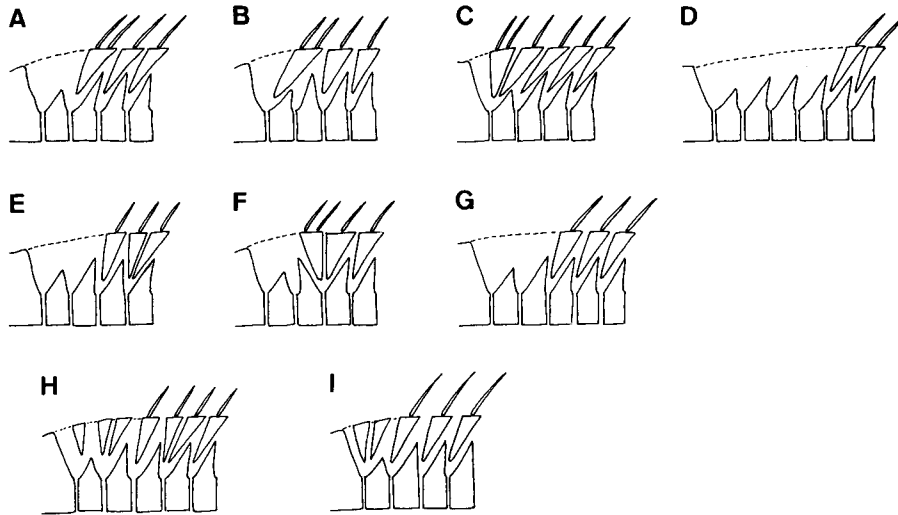

Fig. 31. Insertion of anterior proximal pterygiophore of dorsal series. A-D, conditions observed in the cottoid fishes; E, condition in the platycephalid fish; F, condition in the scorpaenid fishes; G, condition in the liparidid fish; H, generalized percoid type; I, condition in *Niphon* (Serranidae).

phores insert to the first interspace (Fig. 31, C). Type D includes a agonid fish *Podothecus* in which the first pterygiophore is placed in the fifth interspace (Fig. 31, D). Type E includes *Tilesina* in which the first pterygiophore is in the seventh interspace. In the generalized percoid fishes, this character has been described and discussed by many investigators and regarded as one of the important characters for the phylogenetic considerations of these fishes (Katayama, 1959; Smith and Bailey, 1962; Gosline, 1966; Kendahl, 1976; Johnson, 1983). In these fishes, there are two or three predorsal pterygiophores. The first proximal pterygiophore is usually placed in the third interspace, and the second and third in the fourth interspace. In a serranid fish *Niphon spinosus*, the first pterygiophore is in the second interspace (Fig. 31, I). It, therefore, is considered that the condition of type A is the most primitive in the cottoid fishes, because this condition are present in one of the generalized percoid fishes. From this primitive condition, two evolutionary trends could be occurred in the cottoid fishes. One of them is the anterior extension of the dorsal pterygiophore (type A→type B→type C), and another is the retreat of the dorsal pterygiophore (type A→type D→type E). The former trend is occurred in most cottoid fishes, and the latter is occurred only in the agonid fishes.

On the other hand, there are various condition referring to this character in the scorpaeniform fishes here. Type A of the cottoid fishes is observed in the zaniolepidid fishes, and the type B is in the hexagrammid fishes. The type of the generalized percoid fishes is present in the triglid, bembroid, and platycephalid fishes. In the scorpaenid and cyclopteid fishes examined, the first and the second proximal pterygiophore inserts to the third interspace (Fig. 31, F). In the liparidid fishes, the first pterygiophore inserts to the third space.

Number of fin rays supported by the last proximal pterygiophores: Among the

Table 8. Comparison of three characters of the median fin supports in the cottoid fishes. APP, insertion of the anterior proximal pterygiophore of dorsal series; STA, stay; NRL, number of fin rays on last pterygiophores (dorsal-anal). P, primitive condition; D and D', derived conditions on different trends.

Morphotype	Character				Family and genus	
	APP		STA	NRL		
I	2nd interspace	P	absent	D	2-2 P	Cottidae; <i>Jordania</i> , <i>Scorpaenichthys</i> , <i>Hemilepidotus</i>
II		D2			1-2 D1	Hemitripteridae; <i>Nautichthys</i> , <i>Hemitripterus bolini</i>
III	2 pterygiophores in 1st interspace	D2	present	P	1-2 D1	Hemitripteridae; <i>Hemitripterus villosus</i>
IV	2nd interspace	P				Rhamphocottidae; <i>Rhamphocottus</i>
V	1st interspace	D1	absent	D	1-1 D2	Ereuniidae; <i>Marukawichthys</i> , <i>Ereunias</i>
VI	2nd interspace	P				Cottidae; <i>Cottus</i> , <i>Trachidermus</i> , <i>Leptocottus</i> , <i>Radulinus</i> , <i>Orthonopias</i> , <i>Icelus</i> , <i>Ricuzenius</i> , <i>Stelgistrum</i> , <i>Stlengis</i> , <i>Oligocottus</i> , <i>Clinocottus</i> , <i>Leiocottus</i> , <i>Gymnocanthus</i> , <i>Synchirus</i> , <i>Artediellus</i> , <i>Artediellichthys</i> , <i>Zesticelus</i> , <i>Taurocottus</i> , <i>Trichocottus</i> , <i>Argyrocottus</i> , <i>Myozocephalus</i> , <i>Microcottus</i> , <i>Enophrys</i> , <i>Taurulus</i> , Psychrolutidae; <i>Dasycottus</i> , <i>Eurymen</i> , <i>Ebinania</i> , <i>Cotrunculus</i> , <i>Malacocottus</i> , <i>Neophrynichthys</i> , <i>Psychrolutes</i> Agonidae; <i>Agonomalus</i> Hemitripteridae; <i>Blepsias</i>
VII	1st interspace	D1				Cottidae; <i>Chitonotus</i> , <i>Icelinus</i> , <i>Alcichthys</i> , <i>Bero</i> , <i>Ocynectes</i> , <i>Furcina</i> , <i>Pseudoblennius</i> , <i>Vellitor</i>
VIII	5th interspace	D ₁				Agonidae; <i>Podothecus</i>
IX	7th interspace	D ₂				Agonidae; <i>Tilesina</i>

cottoid fishes examined, three conditions are observed in this character. Type A includes the cottid fishes of the genera *Jordania*, *Hemilepidotus* and *Scorpaenichthys*. In these fishes, the last proximal pterygiophores of the dorsal and anal series support two rays. Type B includes the fishes of the genera *Nautichthys*, *Hemitripterus* and *Rhamphocottus*. In these fishes, the last pterygiophore of the dorsal series supports one ray, while that of anal series supports two rays. In type C observed in other cottoid fishes, the last pterygiophores of the dorsal and anal series support a single ray. In the generalized percoid fishes, the last proximal pterygiophores of the dorsal and anal series support two rays. It, therefore, is considered that the condition of type A is most primitive among the cottoid fishes, and type C is most derived condition. The condition of type A is observed in all scorpaeniform fishes examined except for the cyclopterid and the liparidid fishes in which the condition of the type C is observed.

Condition of the stay: This bone had been described as the last distal pterygiophore until Weitzman (1962) used the term "stay". Among the cottoid fishes examined here, this bone is observed in the ereuniid and rhamphocottid fishes. It has been observed in the generalized percoid fishes and other fish groups (Dineen and Stokely, 1956; Potthoff, 1974 and 1975; Houde and Potthoff, 1976; Potthoff et al., 1980). Therefore it is considered that the presence of the stay is the primitive condition in the cottoid fishes. On the other hand, among the scorpaeniform fishes examined here, the stay is present in the most of the other scorpaeniform fishes except for the cyclopterid and liparidid fishes which do not have this bone.

On the basis of the condition of the median fin supports, the cottoid fishes are classified into nine morphotypes summarized in Table 8.

11. CAUDAL SKELETON AND FIN RAYS (Fig. 32; Table 9)

Description. The caudal skeleton is composed of the hypural-parhypural complex bone, the stegural and the epural. A few posterior centra are possessed of somewhat enlarged neural and haemal spines to form the preural centra.

Hypural-parhypural complex bone (HC): This complex bone is a fan-like in shape, and possesses a developed neural prezygapophysis anterodorsally, a small haemal prezygapophysis anteroventrally and a notch posteromedianly. This complex bone supports the principal caudal rays. The hypurapophysis is not developed in the cottoid fishes examined. In the fishes of the families Hemitripterae and cottid genera *Jordania*, *Hemilepidotus* and *Scorpaenichthys*, this complex bone is divided into the upper and the lower lobes. In this condition, a sutural line passes from the haemal prezygapophysis to the posterior notch (Fig. 32, C). In the other cottoid fishes, this complex bone is present as a single bone.

Epural (EPU): The epurals are slightly curved bones and situated on the interspace between the last neural spine and the hypural-parhypural complex bone. They support the procurrent rays of the dorsal series on the dorsal margin. The number of the epurals is usually three in the most of the cottoid fishes, but it is two or three within a species of *Cottiusculus gonez*, *Artediellus dydymovi* and *Dasycottus setiger*. The condition of two epurals is found in *Ascelichthys rhodorus*, *Leptocottus armatus*, *Trachidermus fesciatus* and *Agonomalus jordani*. In the two agonid genera *Tilesina* and *Podothecus*, the epural is present as a single bone.

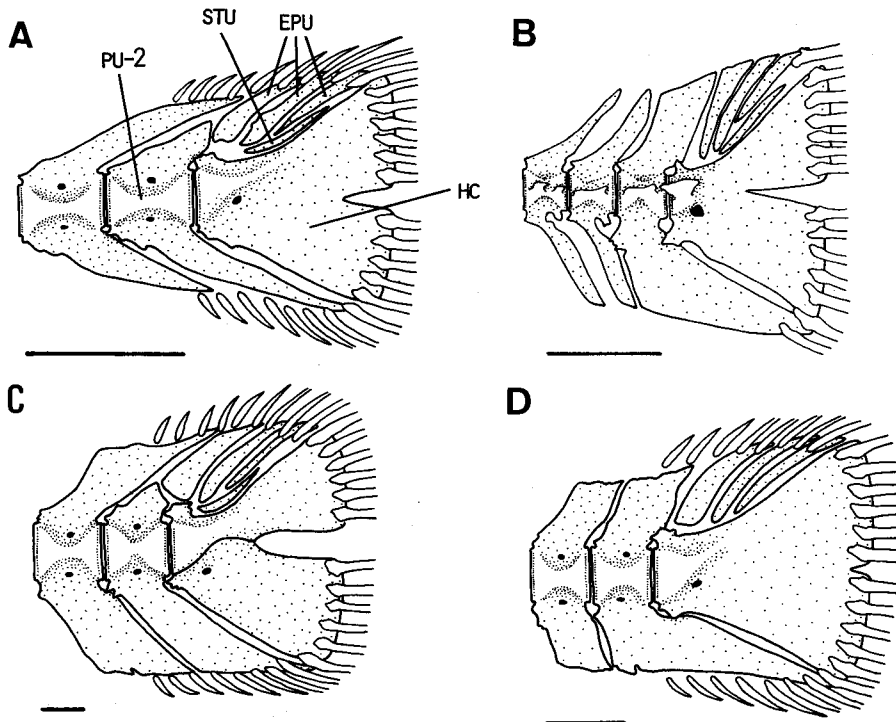

Fig. 32. Lateral aspects of the caudal skeleton in 4 cottoid fishes. A, *Marukawichthys ambulator*; B, *Rhamphocottus richardsoni*; C, *Hemilepidotus gilberti*; D, *Icelus spiniger*. EPU, epural; HC, hypural and parhypural complex; PU-2, second preural centrum; STU, stegural. Scales indicate 2.5 mm.

Stegural (STU): The stegural is a slender bone placed between the epural and the hypural-parhypural complex. This bone is present in the hemitriptid and ereuniid fishes, the psychrolutid fishes of the genera *Dasycottus* and *Ebinania*, and the cottid fishes of the genera *Alcichthys*, *Bero*, *Ascelichthys*, *Chitonotus*, *Hemilepidotus*, *Icelinus*, *Jordania*, *Taurocottus*, *Trichocottus* and *Thyriscus*. This bone is present or absent within a species of *Oligocottus maculosus*, *Pseudoblennius percoides*, *Pseudoblennius cottoides*, *Rhamphocottus richardsoni*, *Scorpaenichthys marmoratus* and *Taurulus bubalis*. In the other cottoid fishes examined here, the stegural is not found.

Preural centrum II (PU-2): The haemal spine of this centrum is present as a plate-like bone which is fused with the centrum. The neural spine of the centrum is elongated in many cottoid fishes, but it is not in the cottid genera *Jordania*, *Hemilepidotus* and *Scorpaenichthys* and the ereuniid genus *Marukawichthys*.

Caudal fin rays: The caudal fin rays are classified into the principal rays and procurrent rays of dorsal and ventral series. The principal rays are supported by the hypural-parhypural complex bone and interconnected by the muscular fibers of the interradianis. The principal rays of the central part of the caudal fin are branched in the most of the cottoid fishes, while they are unbranched in the fishes

of the families Agonidae and Rhamphocottidae, and the hemitripterid genera *Hemitripterus* and *Blepsias*. The procurent rays of the dorsal series are supported by the epurals and the neural spines of a few posterior centra. The procurent rays of the ventral series are supported by the haemal spines of a few posterior centrum.

Discussion. The caudal skeleton has been regarded as one of the important characters to consider the phylogeny of the teleostean fishes. In the cottoid fishes, the caudal skeleton has been described by Girard (1852), Johnson (1918), Taliev (1955), Quast (1965), Monod (1967), Cowan (1971) and Yabe (1981, 1983). But the variations of this region has not been sufficiently clarified in the cottoid fishes. In the present study, the variations within the cottoid fishes are found in the number of elements of the hypural-parhypural complex bone, the condition of the neural spine on the preural centrum II, the condition of the caudal fin rays, the number of epurals and presence or absence of the stegural. In addition to these characters, the differences between the cottoid fishes and the generalized percoid fishes are found in the condition of the haemal spine on the preural centra and the condition of the hypurapophysis. Among these characters, the interspecific variations are found in the conditions of the stegural and the epural. Therefore, these conditions are not used in the following consideration.

Number of the elements of the hypural-parhypural complex: On the basis of this character, the cottoid fishes are classified into two types. The first type, type A, includes all hemitripterid fishes and the cottid genera *Jordania*, *Hemilepidotus* and *Scorpaenichthys*. In these fishes, the hypural-parhypural complex bone is composed of the upper and the lower elements. The second type, type B, includes other cottoid fishes in which the hypural-parhypural complex bone is present as a single bone. In the generalized percoid fishes, the complex bone is separated into five hypurals, the parhypural and the urostyle (Gosline, 1961 a, b, 1966; Monod, 1967; Patterson, 1968; Johnson, 1983). It is assumed that the progressive fusion of the hypural elements may be occurred from the generalized percoid type in the evolutionary process of the cottoid fishes. It can be regarded that the lower lobe of the complex bone in type A is the fusion among the parhypural and the hypurals I and II, and the lower lobe is the fusion among the hypurals III, IV, (V), and the urostyle. In type B, all elements are fused to form a fan-shaped bone. It, therefore, is considered that type A is the primitive condition among the cottoid fishes, and type B is the derived condition occurred by the progressive fusion of the hypural elements.

The intermediate conditions of this character between the cottoid types and the generalized percoid type are found in the scorpaeniform fishes examined. The generalized percoid type is observed in a scorpaenid fish *Setarches*. In the other scorpaenoid fishes, the caudal skeleton is composed of three or four hypurals, the parhypural and the urostyle. In the anoplomatid fishes, the complex bone is four hypurals, the parhypural and the urostyle. In hexagrammid and the liparidid fishes, the complex bone is divided into the upper and the lower lobes and the urostyle. In the zaniolepidid and the cyclopterid fishes, the condition of this complex bone is similar to that in type A.

Neural spine of the preural centrum II: The neural spine of the preural centrum II is elongated in many cottoid fishes, while it is not in the fishes of the

Table 9. Comparison of three characters of the caudal skeleton in the cottoid fishes. HPC, number of elements of the hypural-parhypural complex bone; NPP, neural spine on the preural centrum 2; CFR, condition of the caudal fin rays. P, primitive condition; D, derived condition.

Morphotype	Character				Family and genus		
	HPC		NPP			CFR	
I	2	P	short	P	branched	P	Cottidae; <i>Jordania</i> , <i>Scorpaenichthys</i> , <i>Hemilepidotus</i>
II			long	D			branched
III					unbranched	D	
IV	1	D	long	D			branched
V					Ereuniidae; <i>Ereunias</i> Cottidae; <i>Cottus</i> , <i>Leptocottus</i> , <i>Chitonotus</i> , <i>Orthonopias</i> , <i>Icelus</i> , <i>Ricuzenius</i> , <i>Stelgistrum</i> , <i>Thyriscus</i> , <i>Stlengis</i> , <i>Icelinus</i> , <i>Radulinus</i> , <i>Asemichthys</i> , <i>Astrocottus</i> , <i>Triglops</i> , <i>Artedius</i> , <i>Oligocottus</i> , <i>Clinocottus</i> , <i>Leiocottus</i> , <i>Gymnocanthus</i> , <i>Synchirus</i> , <i>Artediellus</i> , <i>Artediellichthys</i> , <i>Cottiusculus</i> , <i>Zesticelus</i> , <i>Taurocottus</i> , <i>Trichocottus</i> , <i>Myozocephalus</i> , <i>Porocottus</i> , <i>Microcottus</i> , <i>Argyrocottus</i> , <i>Enophrys</i> , <i>Taurulus</i> , <i>Alcichthys</i> , <i>Bero</i> , <i>Ocynectes</i> , <i>Furcina</i> , <i>Pseudoblennius</i> , <i>Vellitor</i> , <i>Ascelichthys</i>		
VI						short	

genera *Jordania*, *Hemilepidotus*, *Scorpaenichthys*, *Marukawichthys* and *Trachidermus*. In the generalized percoid fishes, the neural spine of the preural centrum II is not developed (Gosline, 1961a, 1966; Monod, 1967; Patterson, 1968; Johnson, 1983). Therefore the condition having elongated neural spine of the preural centrum II is the derived condition in the cottoid fishes.

Among the scorpaeniform fishes examined, this derived condition is found in the cyclopterid and liparidid fishes. In the other scorpaeniform fishes, the neural spine of the preural centrum II is not developed.

Condition of the caudal fin rays: In many cottoid fishes, the caudal fin is composed of several branched rays, while it is composed of unbranched rays in the agonid, rhamphocottid fishes, and the hemitripteriid genera *Hemitripterus* and *Blepsias*. It is reported that fifteen branched rays are present on the caudal fin in the generalized percoid fishes (Gosline, 1962; Katayama, 1959; Patterson, 1968). Therefore the condition that the caudal fin composed of only unbranched rays is derived in the cottoid fishes.

Haemal spines on the preural centra: In the all cottoid fishes examined, the haemal spine of each preural centrum is fused with its centrum, while the spines of the preural centra I and II are suturally attached to the centra in the generalized percoid fishes (Gosline, 1961a, 1966; Monod, 1967; Patterson, 1968; Johnson, 1983). It, therefore, is considered that the former condition is the synapomorphy of all cottoid fishes. In all scorpaeniform fishes examined except for the liparidid fish, the haemal spine of the preural centrum II (and III) are suturally attached to the centrum. A liparidid representative, *Liparis tessellatus*, has haemal spine fused to the preural centrum II. It, therefore, is considered that the condition of the cottoid fishes is rather unique condition among the scorpaeniform fishes.

Hypurapophysis: In all cottoid fishes examined, the hypurapophysis is absent. *Rhamphocottus richardsoni* has a low process on the hypural-parhypural complex. But it is considered that this process is not homologous to the hypurapophysis, because this process is placed on the region of the urostyle, while the hypurapophysis is placed on the parhypural or its region. The process in *Rhamphocottus* may be identified as the last lateral process of the caudal vertebrae. Since the hypurapophysis has been observed in the generalized percoid fishes (Gosline, 1961a; Nursall, 1963b; Patterson, 1968; Johnson, 1983), it is considered that the condition without the hypurapophysis is the derived condition and the synapomorphy of all cottoid fishes. Among the other scorpaeniform fishes examined, this derived condition observed in the hexagrammid, cyclopterid and liparidid fishes.

On the basis of the conditions of the caudal skeleton, the cottoid fishes are classified into six morphotypes summarized in Table 9.

VI. Comparative myology

1. MUSCLES OF THE CHEEK (Figs. 33-35)

Description

COTTOID FISHES: There are seven muscles serving the cheek region; the adductor mandibulae, the levator arcus palatini, the dilatator operculi, the adductor arcus palatini, the adductor operculi, the levator operculi and the adductor hyoman-

dibulae.

Adductor mandibulae (A1, A2, A3, Aw): The adductor mandibulae is subdivided into four sections. The section A1 lies on the most dorsal and superficial part of the cheek region. It originates from the medial surface of the suborbital stay and from the dorsolateral margin of the preopercle. In the cottid fishes, this section is connected with the lateral process of the hyomandibular by a strong tendon posterodorsally. The anterior tip of this section is converted into a strong tendon, and inserts to the medial surface of the maxillary head. In the agonid genera *Podothecus* and *Tilesina*, the anterior tip of this section is divided into two tendons. One of them inserts to the medial surface of the maxillary head, and the other tendon is converged to the ligamentum primordium (LIP) inserting to the lateral surface of the maxillary head. This section is also connected with the ligamentum primordium anteroventrally. Medially, some fibers of this section is connected with the sections A 2 and A 3. The section A 2 lies on the ventrolateral part of the cheek region. It originates from ventrolateral surface of the suspensorium and inserts to the ascending process of the angular. Anteromedially, this section is fused to the section A 3 and is connected with the section Aw by an aponeurosis. In the psychrolutid genera *Eurymen* and *Psychrolutes*, and the cottid genera *Ascelichthys*, *Cottus*, *Trachidermus*, and *Triglops*, a tendinous tissue extends from the anterolateral surface of the section A 2 to the ligamentum primordium. The section A 3 lies on the dorsomedial part of this muscle. This section originates from the metapterygoid, the symplectic and the hyomandibular. Anteriorly, this section is converged to the sections A 1 and A 2, and is fused to the section Aw. The complex muscular mass of the sections A 1, A 2 and A 3 is possessed of a tendon which extends from the anteromedial part of this complex to the coronomeckelian. The section Aw is situated on the medial surface of the lower jaw. Posteriorly, this section is fused with the complex muscle of the sections A 1, A 2 and A 3 by an aponeurosis. This section is connected with the medial surface of the quadrate.

Levator arcus palatini (LAP): This muscle occupies the postorbital portion of the cheek region. This muscle originates from the lateral surface of the hyomandibular and the preopercle, and inserts to the ventrolateral surface of the sphenotic. Superficially, this muscle has two tendinous inserting heads. The anterior head inserts to the anterolateral process of the sphenotic, and the posterior head inserts to the posterodorsal process of the sphenotic.

Dilatator operculi (DO): This muscle originates from the dorsolateral fossa of the pterotic just above the anterior craniohyomandibular articulation, and from the lateral face of the posterodorsal part of the hyomandibular. This muscle inserts to the process at the anterodorsal corner of the opercle.

Adductor arcus palatini (AAP): This muscle is situated on the floor of the orbit cavity. This muscle originates from the ventrolateral margin of the parasphenoid. Some fibers of this muscle originate from the anterolateral face of the prootic. This muscle inserts to the dorsal margins of the palatine and the entopterygoid, and to the dorsomedial surfaces of the quadrate and metapterygoid.

Adductor operculi: This muscle originates from the ventral surface of the pterotic and the lateral face of the exoccipital, and inserts to the dorsomedial surface of the opercle. This muscle usually fuses with the adductor hyomandibulae.

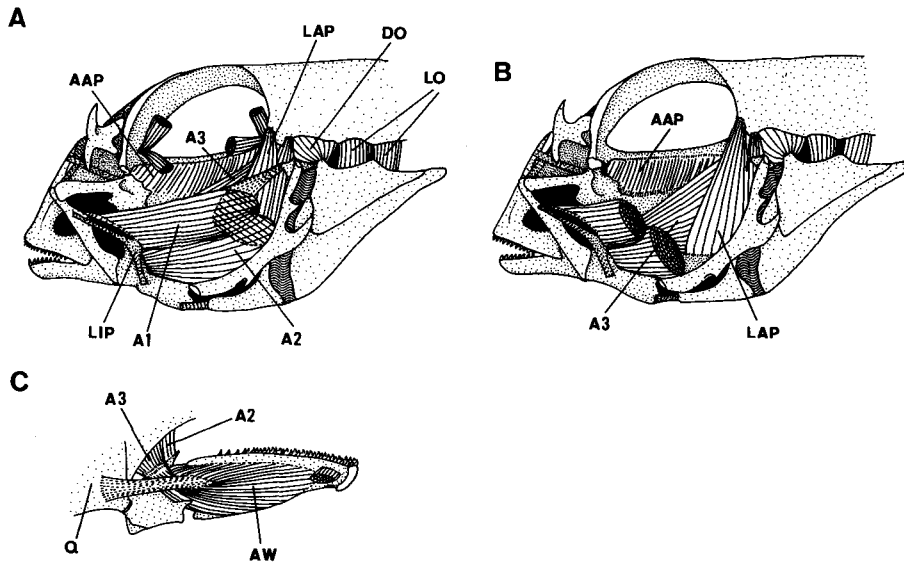

Fig. 33. Cheek muscle of *Jordania zonope*. A, superficial musculature; B, after removal of A1 and A2; C, medial surface of the lower jaw. A1, A2, A3 and Aw, adductor mandibulae; AAP, adductor arcus palatini; DO, dilator operculi; LAP, levator arcus palatini; LIP, ligamentum primordium; LO, levator operculi; Q, quadrate.

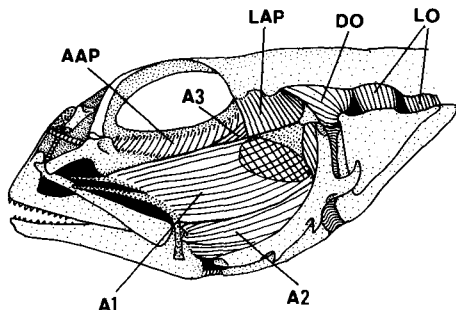

Fig. 34. Cheek muscle of *Cottus polux*.
For abbreviations, see Fig. 33.

Levator operculi (LO): This membranous muscle is separated into two sections. The anterior section originates from the ventrolateral surface of the pterotic and inserts to the dorsal margin of the opercle just behind the insertion of the adductor operculi. The posterior section originates from the lateral margin of the posttemporal and inserts to the posterodorsal margin of the opercle.

Adductor hyomandibulae: This muscle originates from the ventral surface of the prootic and the dorsal surface of the exoccipital, and inserts to the medial surface of the posterodorsal process of the hyomandibular. Anteriorly, this muscle is connected with the posterior part of the adductor arcus palatini by membranous muscular fibers. Posteriorly this muscle adjoins the adductor operculi.

SCORPAENIFORM FISHES: Among the scorpaeniform fishes examined, the distributional pattern of the adductor mandibulae is remarkably changed, but the patterns of the other cheek muscles are almost as same as those of the cottoid fishes.

Adductor mandibulae: Among scorpaeniform fishes examined, the distributional pattern of the adductor mandibulae is sharply divided into six types. Type A includes the fishes of the *Sebastes*, *Sebastolobus*, *Setarches*, *Pterois* and

Helicolenus, and the anoplomatid, zaniolepidid, bembroid and platycephalid fishes (Fig. 35, A). In these fishes, the sections A 1, A 2 and A 3 are not clearly separated. The anterior tip of the section A 1 is converted into a strong tendon, and inserts to the medial face of the maxillary head. The section A 1 connects to the ligamentum primordium anteroventrally. This section is not firmly connected with the suborbital stay. Type B includes the scorpaenid genera *Apistus* and *Hypodytes*, and synanceiid fishes (Fig. 35, C). In these fishes, the sections A 1, A 2 and A 3 of the adductor mandibulae are well separated each other. The anterior tip of the section A 1 is divided into two short tendons. One of them inserts to the medial surface of the maxillary head, and the other inserts to the lateral face of the maxillary head at the same position where the ligamentum primordium inserts. The section A 1 connects with the ligamentum primordium anteroventrally. This section is firmly connected with the suborbital stay in *Apistus*. Type C includes the hexagrammid fishes (Fig. 35, D). In these fishes, the condition of the cheek region is almost as same as that in type A except for the presence of the connection between the section A 2 and the ligamentum primordium anteroventrally. This connection is made by a tendinous tissue. Type D includes the triglid fishes (Fig. 35, E). In this type, the section A 1 of the adductor mandibulae is present as a small muscular mass which originates from the medial surface of the suborbital stay. The anterior tip of the section A 1 is divided into two tendons. One of them inserts to the medial surface of the maxillary head, and the other inserts to the lateral surface of the maxillary head.

Type E includes the cyclopterid fishes (Fig. 35, F). In these fishes, the section A 1 of the adductor mandibulae is divided into two parts; the dorsomedial part and the ventrolateral part. The dorsomedial part of the section A 1 is situated between the ventrolateral part of the section A 1 and the levator arcus palatini, and is fused with the ventrolateral part posteriorly. Anterior tip of this part is converted into a long tendon and inserts to the medial surface of the maxillary head. The ventrolateral part of this section originates from the anterolateral surface of the preopercle. Anterior tip of this part is converted into a strong tendon, and inserts to the posterior part of the maxillary. The section A 2 of the adductor mandibulae is possessed of two inserting heads anteriorly. The lateral head inserts to the posterior part of the mandibular just posterior to the insertion of the ventrolateral part of the section A 1. The medial head inserts to the ascending process of the angular, the posterior end of the dentary and the connective tissue between the maxillary and the articular. The ligamentum primordium attaches to the ventromedial part of this section. Type F includes the liparidid fishes (Fig. 35, G). In these fishes, the section A 1 of the adductor mandibulae is separated into two parts. The dorsomedial part of this section originates from the metapterygoid. Some fibers of this part extend under the levator arcus palatini. Anterior tip of this part is converted into a strong tendon and inserts to the medial surface of the maxillary head. The ventrolateral part of the section A 1 is originated from the anterior surface of the preopercle. Anterodorsally, a thin tendon extends from this part, and fuses with the anterior tendon of the dorsomedial part. Anteroventrally, this part is tendinously connected with ascending process of the angular and the posterior tip of the dentary. The section A 2 of the adductor mandibulae is

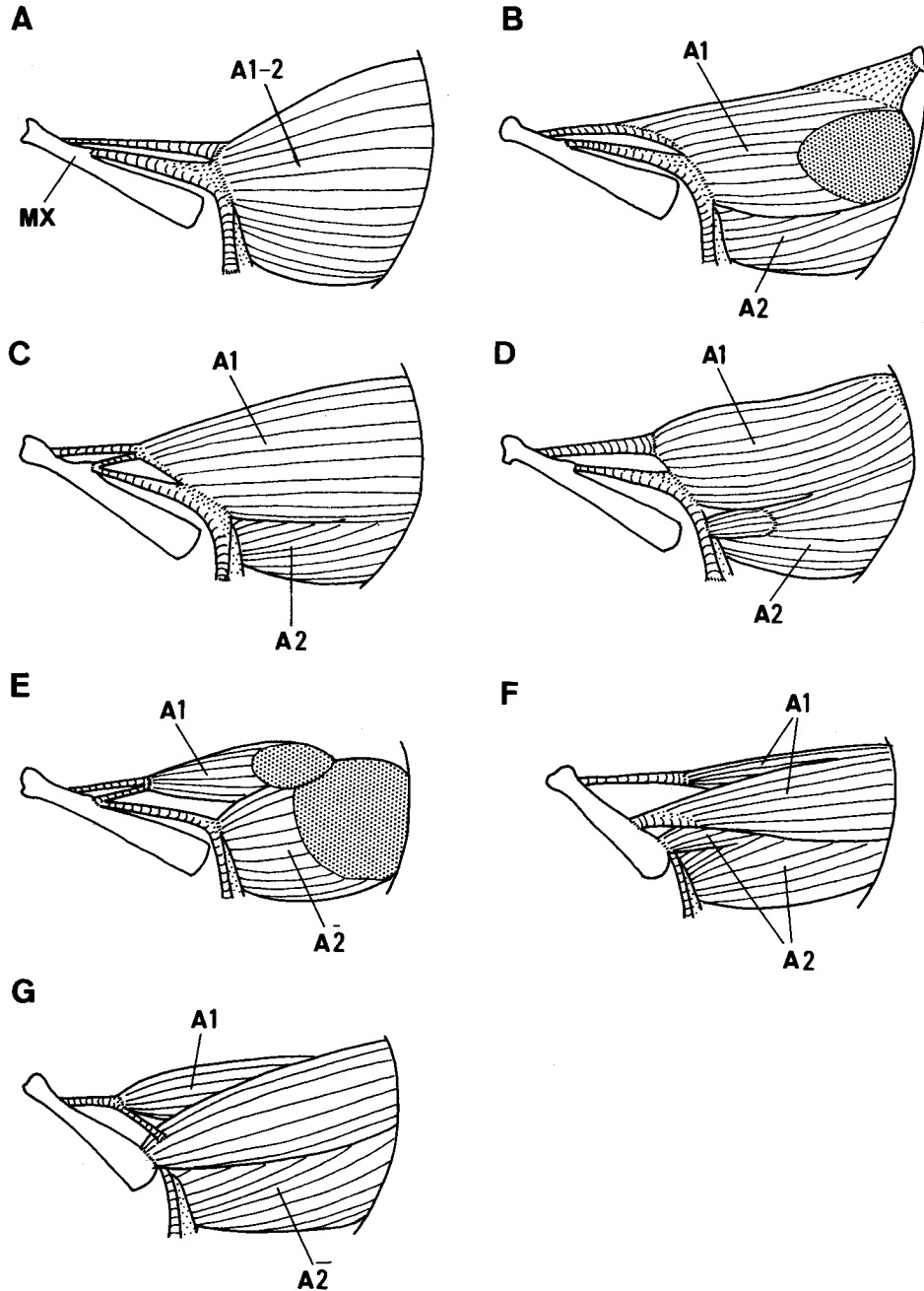

Fig. 35. Seven types of the adductor mandibulae in the scorpaeniform fishes. A, typical condition of the scorpaenid fishes; B, typical condition of the cottoid fishes; C, *Apistus* type; D, hexagrammid type; E, triglid type; F, cyclopterid type; G, liparidid type. A1, adductor mandibulae section A1; A2, adductor mandibulae section A2; MX, maxillary.

tendinously connected with the ligamentum primordium and the posterior end of the maxillary anterolaterally, and with the ascending process of the angular and the posterior end of the dentary anteromedially.

Discussion. The cheek muscle of the cottoid and other scorpaeniform fishes have been examined by Allis (1909), Dietz (1914), Cowan (1969) and Adamicka (1972). In these studies, the various conditions of the cheek muscles have been described, but the variation of these muscles within the cottoid fishes have not been obscure. In the present study, it is confirmed that the general conditions of the cheek muscles are uniform except for a few variations referring to the adductor mandibulae among the cottoid fishes. On the other hand, the condition of the adductor mandibulae is remarkably changed among the scorpaeniform fishes, and it is classified into seven morphotypes described above (Fig. 35). It has been described that the generalized percoid fishes are possessed of the adductor mandibulae in which the separation between the sections A 1, A 2 and A 3 is not clear and the anterior tip of the section A 1 is converted into a tendon inserting to the medial surface of the maxillary head (Dietz, 1914; Osse, 1969; Winterbottom, 1974a; Johnson, 1980). This condition agrees with the type A of the scorpaeniform fishes (Fig. 35, A). In most of the cottoid fishes, the adductor mandibulae is possessed of only a few specialization in comparison with the generalized percoid type; 1) the separation among the each section is more distinct, 2) the muscular fibers of the section A 1 originate from the medial surface of the suborbital stay, 3) the tendinous connection between the section A 1 and the lateral process of the hyomandibular is well developed (Fig. 35, B). In the addition to these conditions, some members of the cottoid fishes have another specializations. In the fishes of genera *Eurymen*, *Psychrolutes*, *Ascelichthys*, *Cottus*, *Trachidermus* and *Triglops*, the section A 2 is connected with the ligamentum primordium by a thin tendon. This modification is also observed in the type C of the scorpaeniform fishes. Therefore it is considered that the typical condition in the cottoid fishes is regarded as a slightly derived condition in comparison with that of the generalized percoid fishes (= the type A in the scorpaeniform fishes). The modifications observed in some of the cottoid fishes are regarded as the additional derived condition from the typical condition of the cottoid fishes.

On the other hand, the cyclopterid and liparidid fishes are possessed of the highly specialized condition of the adductor mandibulae defined as types E and F. In these fishes, the section A 1 is divided into two parts (superficial and profundus). It is considered that these conditions are the most derived conditions in the scorpaeniform fishes.

The conditions of the characters discussed here in the cottoid fishes are summarized in Table 12. The distributional patterns of each characters among the scorpaeniform fishes are shown in Table 13.

2. MUSCLES SERVING THE HYOID ARCH (Figs. 36-37)

Description

COTTOID FISHES. There are five muscles serving the hyoid region; the intermandibularis, the protractor hyoidei, the hyohyoidei adductores, the hyohyoidei inferioris, the hyohyoidei abductores.

Intermandibularis (IMD): This muscle lies immediately behind the symphysis of the halves of the lower jaw, and is connected with the posterodorsomedial face of each dentary. This muscle is well developed but almost completely sandwiched between the inner and outer layers of the anterior part of the protractor hyoidei.

Protractor hyoidei (PRH): This muscle originates from the anteromedial faces of left and right dentaries just behind the symphysis, both dorsal and ventral to the intermandibularis. The fibers of this muscle extend backward and split into the left and right sections. Each section inserts on the ventrolateral face of the ceratohyal just before base of the third branchiostegal ray (the fourth in the psychrolutid fishes).

Hyochoidei adductores (HAD): This muscle is present as a sheet of fibers among the more distal portions of the branchiostegal rays, and continues dorsal to the posteriormost ray and attaches to the medial faces of the subopercle and the opercle.

Hyochoides inferioris (HIF): In the cottoid fishes, only some species have this muscle; *Hemiteripterus bolini*, *Ebinania*, *Psychrolutes*, and *Neophrynichthys*. In these fishes, this muscle originates from the ventromedial face of the ceratohyal and runs dorsal to the first and the second (and the third in the latter three species) branchiostegals, and fuses to its antimere on the ventral midline. Anteriorly this muscle is connected with the hypohyals by a thin tendinous tissue (Fig. 36, D).

Hyochoidei abductores (HHA): This muscle is composed of two sections of muscular masses. The first section originates from the ventral or medial face of the hyoid arch and/or from base of the preceding branchiostegal ray and inserts somewhat distal to the base of the succeeding ray except for the last one (HHA-1). The second section of this muscle arises from the first branchiostegal ray and extends to the ventral midline where it fuses with its antimere by a median raphe (HHA-2). Anteriorly, this section is connected with the hypohyals by a pair of tendons. In some cottoid fishes for example *Cottus*, *Trachidermus* and *Leptocottus*, the anterior part of this muscle forms indistinctly separated muscular mass (Fig. 36, C).

SCORPAENIFORM FISHES: In the scorpaeniform fishes examined here, the conditions of the intermandibularis, the protractor hyoidei, the hyochoidei adductores and the hyochoidei abductores section 1 are almost as same as those in the cottoid fishes.

Hyochoides inferioris (HIF): This muscle is present in the following examined genera; *Minous* and *Inimicus* (Synanceiidae), *Anoplopoma* and *Erilepis* (Anoplopomatidae), *Rogadius* (Platycephalidae), *Eumicrotremus* and *Aptocyclus* (Cyclopteridae) and *Liparis* (Liparididae). In these fishes, the distributional patterns of this muscle are well varied. In *Rogadius*, this muscle originates from anteroventral surface of the hypohyal, and crosses over its antimere in the ventral midline to attach to the medial face of the ceratohyal just before the base of the fourth branchiostegal ray. This muscle is always medial to the hyochoidei abductores section 2 (Fig. 37, C). In two anoplopomatid fishes, this muscle originates from anteroventral surface of the hyoid arch and crosses over its antimere to attach to the medial face of the ceratohyal. This muscle is anterior to the hyochoidei abductores section 2, and is fused with the latter posteriorly (Fig. 37, D). In two synanceiid fishes, this muscle originates from medial surface of the ceratohyal, and

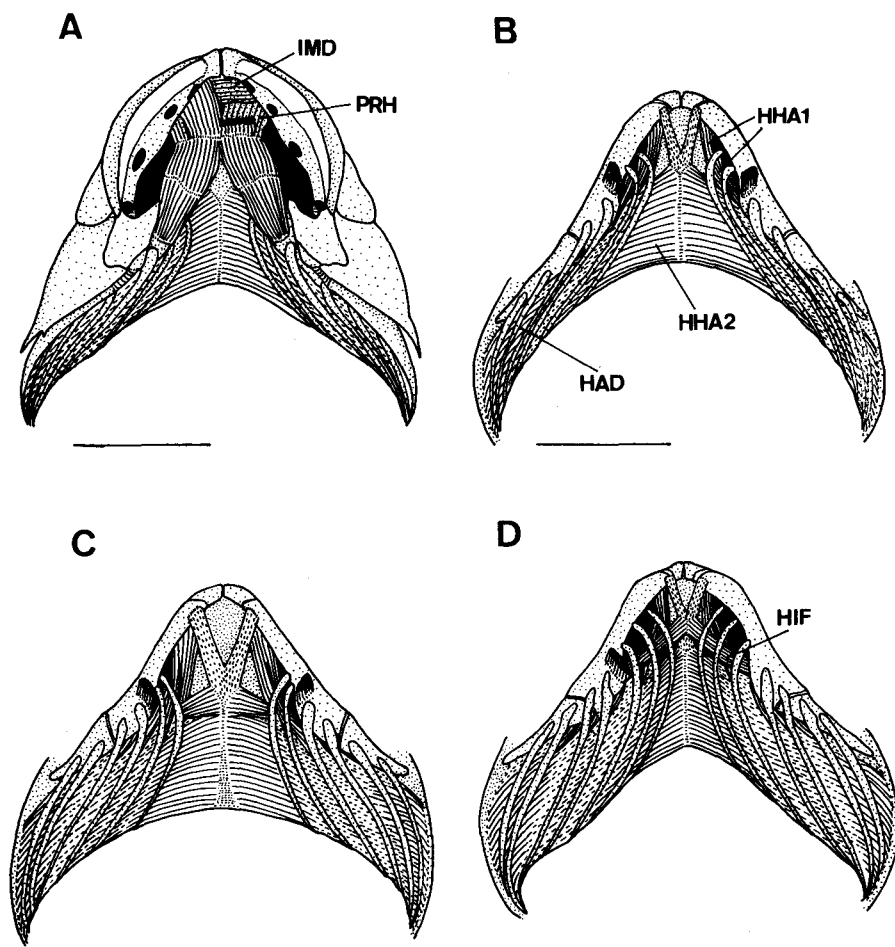

fig. 36. Muscles serving the hyoid arch of the cottoid fishes. A, *Hemilepidotus hemilepidotus* (protractor hyoidei is partly removed); B, *Hemilepidotus hemilepidotus* (protractor hyoidei is removed); C, *Cottus pollux*; D, *Ebinania brephocephala*. HAD, hyohyoidei adductores; HHA-1, hyohyoidei abductores section 1; HHA-2, hyohyoidei abductores section 2; HIF, hyohyoidei inferioris; IMD, intermandibularis; PRH, protractor hyoidei. Scales indicate 10 mm.

runs medial to anterior three branchiostegal rays and reaches ventral midline where it is fused to its antimere. Posteriorly this muscle is converged with hyohyoidei abductores section 2. This muscle is not directly but tendinously connected with the anterior part of the hyoid arch (Fig. 37, E). In three cyclopterid and liparidid fishes, this muscle is well developed. It originates from the medial surface of the ceratohyal and reaches the ventral midline to fuse to its antimere. This muscle is completely separated from the hyohyoidei abductores section 2 (Fig. 37, F).

Hyohyoidei abductores section 2 (HHA-2): This muscle is present in all scorpaeniform fishes examined, but two different distributional patterns observed.

In the scorpaenid, bembroid, platycephalid and triglid representatives, this muscle arises from the first branchiostegal ray and crosses over its antimere to reach the ventral face of the hypohyal of the opposite side (Fig. 37, A-C). In almost all fishes of this type, the muscular mass arising from the branchiostegal ray on the left side is ventral to that on the right side, while the muscular mass on the right side is ventral to that on the left side in *Apistus* and *Hypodytes* (Fig. 37, B). In the other scorpaeniform fishes examined, this muscle arises from the first branchiostegal ray and extends to ventral midline where it is fused with its antimere with a median raphe (Fig. 37, D-G). In two anoplomatid fishes, the posterior half of this muscle is fused with its antimere, while the anterior half is not fused with its antimere but with the hyohyoideus inferioris (Fig. 37, D).

Discussion. The muscles of the hyoid region of the cottoid fishes and other

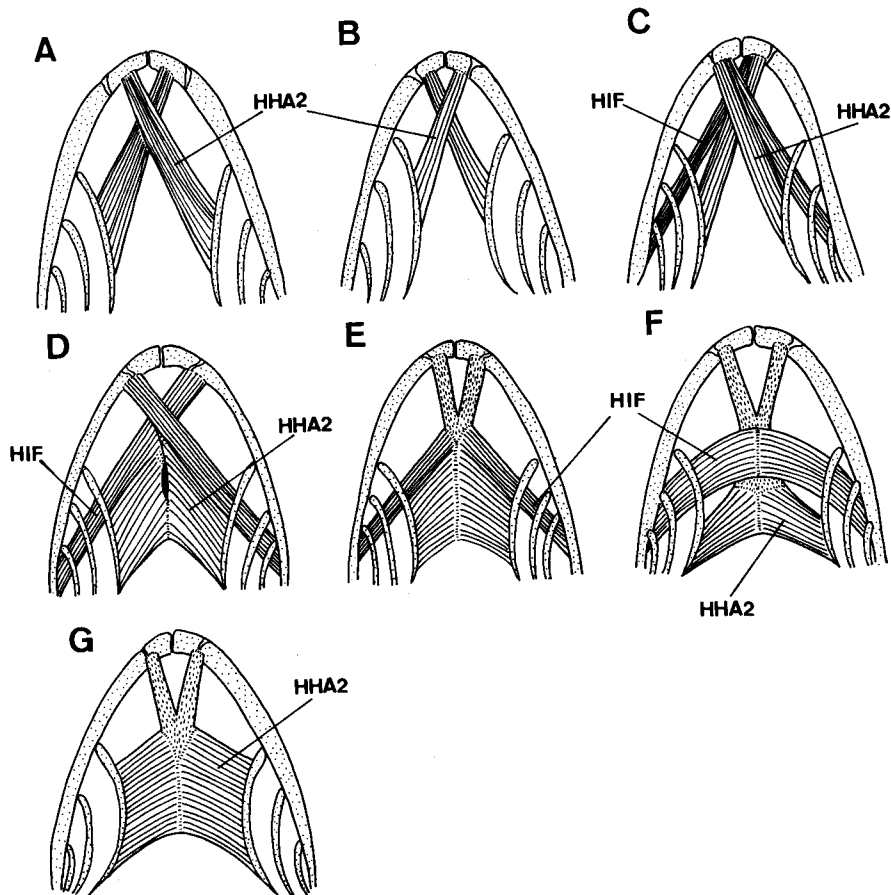

Fig. 37. Seven types of the hyohyoideus complex in the scorpaeniform fishes. A, scorpaenid type (type A-1 in text); B, *Apistus* type (type A-2); C, platycephalid type (type B); D, anoplomatid type (type C); E, synanceiid type (type D-1); F, cyclopterid type (type D-2); G, cottoid-hexagrammid type (type E). For abbreviations, see Fig. 36.

scorpaeniform fishes have been examined only by Dietz (1914) and Winterbottom (1974a), but these studies were based on limited materials. In the present study, the hyoid muscles of many cottoid fishes are examined, and compared with those of the other scorpaeniform fishes. As a result of these examinations, it is clarified that the condition of the hyohyoideus muscles is changed in the cottoid fishes, and it is more complicatedly changed in the scorpaeniform fishes.

In the cottoid fishes examined here, the condition of the hyohyoidei abductores section 2 which is fused with its antimere is uniform, but that of the hyohyoideus inferioris is changed and is divided into two types. In the type I, this muscle is present as a slender muscular mass and fused with its antimere on the ventral midline. In the type II, this muscle is absent. The former type is observed only in some cottoid genera, while the latter is observed in most of the cottoid fishes. It has been described that the hyohyoidei abductores section 2 crosses over its antimere and the hyohyoideus inferioris is absent in the generalized percoid fishes (Osse, 1969; Liem, 1970; Winterbottom, 1974a; Elshould-Oldenhave and Osse, 1976). The hyohyoidei abductores section 2 of the generalized percoid fishes is greatly different from that of the cottoid fishes. The morphological gap between the cottoid type and the generalized percoid type is so large that the polarity of this character in the cottoid fishes is hardly confirmed on the basis of the comparison of only these types.

On the other hand, the scorpaeniform fishes examined here are classified into five types with four subtypes by the combination of the conditions of the hyohyoidei abductores section 2 and the hyohyoideus inferioris (Table 10). Type A is the condition that the hyohyoidei abductores section 2 crosses over its antimere and the hyohyoideus inferioris is absent. This type agrees with the generalized percoid type. Type B is the condition that both hyohyoideus muscles cross over their antimeres. Type C is the condition that the hyohyoidei abductores section 2 is fused with its antimere and the hyohyoideus inferioris crosses over its antimere. Type D is the condition that both hyohyoideus muscles are fused with their antimeres. This type is subdivided into two subtypes. In subtype D-1, the hyohyoideus inferioris is present as a slender muscular mass. This subtype is observed in the synanceiid representatives, and agrees with the type I of the cottoid fishes. In subtype D-2, the hyohyoideus inferioris is well developed to form a wide muscular band. Type E is the condition that the hyohyoidei abductor is fused with its antimere and the hyohyoideus inferioris absent. This type is observed in the hexagrammid and zaniolepidid fishes, and agrees with type II of the cottoid fishes. It is considered that the morphological gap between the cottoid type and the generalized percoid type could be filled up by the various types in the other scorpaniform fishes. Type A which is same condition as the generalized percoid type is regarded as the most primitive among the all types of the scorpaeniform fishes. From this condition, a hypothetical evolutionary trend of this character can be inferred. This trend is the processes from the appearance, through the modification, to disappearance of the hyohyoideus inferioris, and of the modification of the hyohyoidei abductores section 2. On the basis of this trend, it is considered that the type I of the cottoid fishes (=type D-1) is the primitive condition within the cottoid fishes, and the type II (=type E) is the derived condition.

Table 10. Comparison of the hyohyoideus complex in the scorpaeniform fishes.

Morphotype	Character and condition		Family and genus
	Hyohyoidei adductores II	Hyohyoideus inferioris	
Type A-1	crossing each other ; the right bundle passing medially to the left	absent	Scorpaenidae : <i>Setarches</i> , <i>Pterois</i> , <i>Sebastes</i> , <i>Sebistolobus</i> , <i>Helicorenus</i> Bembridae : <i>Bembris</i> Triglidae : <i>Lepidotrigla</i>
Type A-2	crossing each other ; the right bundle passing medially to the left	absent	Scorpaenidae : <i>Apistus</i> , <i>Hypodytes</i>
Type B	crossing each other	crossing each other	Platycephalidae : <i>Rogadius</i>
Type C	fusing each other	crossing each other	Anoplopomatidae : <i>Anoplopoma</i> , <i>Erelepis</i>
Type D-1	fusing each other	fusing each other ; not developed	Synanceiidae : <i>Minous</i> Hemitripteridae : <i>Hemitripterus bolini</i> Psychrolutidae : <i>Neophrunichthys</i> , <i>Ebinania</i> , <i>Psychrolutes</i>
Type D-2	fusing each other	fusing each other ; well developed	Cyclopteridae : <i>Eumicrotremus</i> , <i>Aptocyclus</i> Lipalididae : <i>Liparis</i>
Type E	fusing each other	absent	Hexagrammidae : <i>Hexagrammos</i> , <i>Oxlebius</i> , <i>Pleurogrammus</i> Zaniolepididae : <i>Zaniolepis</i> Hemitripteridae : <i>Nautichthys</i> , <i>Blepsias</i> , <i>Hemitripterus villosus</i> Psychrolutidae : <i>Dasycottus</i> , <i>Eurymen</i> , <i>Malacocottus</i> , <i>Cottunculus</i> Ereuniidae, Rhamphocottidae, Agonidae, Cottidae

3. MUSCLES SERVING THE BRANCHIAL ARCH (Figs. 38-41)

Description

COTTOID FISHES: The dorsal part of the branchial arch is served by seven muscles ; the levator externus, the levator internus, the levator posterior, the transversus dorsalis, the obliquus dorsalis, the obliquus posterior and the retractor dorsalis. The ventral part of the branchial arch is served by six muscles ; the rectus ventralis, the obliquus ventralis, the transversus ventralis, the rectus communis, the adductor and the pharyngoelavicularis.

Levator externus (LE): There are three elements of the levator externus. They have a common originating position which is the prootic just ventral and medial to the craniohyomandibular articulation. They insert on the dorsolateral surfaces of the first, second and fourth epibranchials (LE-I, II, IV). The muscular masses of the levatores externi I and II are equally developed, while that of the levator externus IV is prominently developed. The levator externus III inserting to the third epibranchial is absent. Some fibers of the levator externus IV insert to the dorsal process of the third epibranchial in *Triglops* and *Ascelichthys*, but they do not

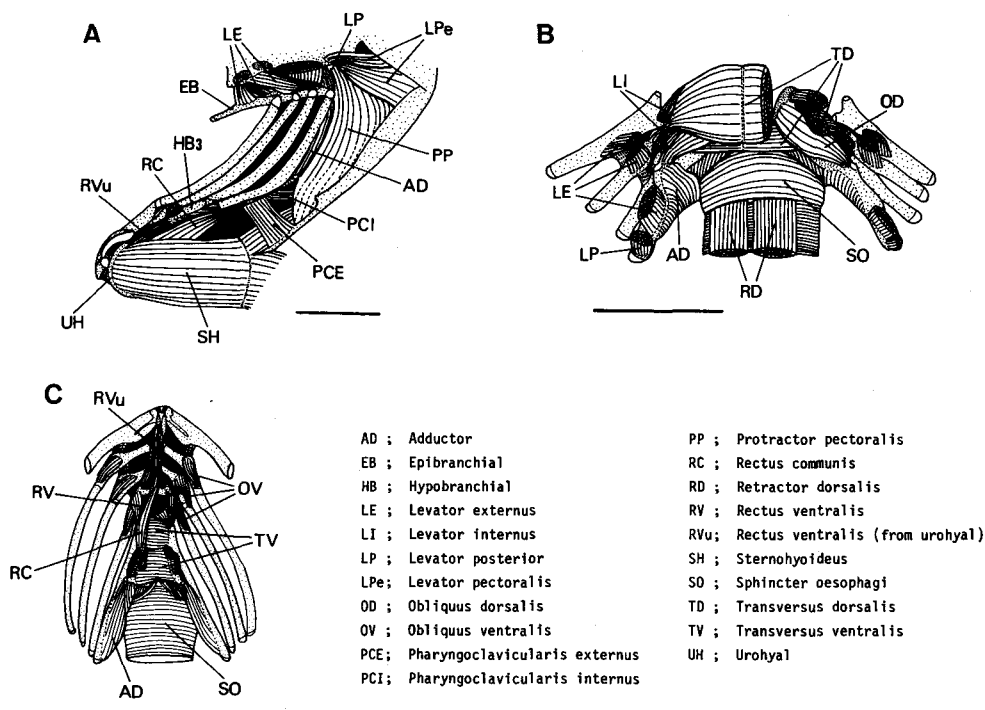

Fig. 38. Muscles serving to the branchial arch in a cottid fish, *Icelus spiniger*. A, lateral aspect; B, dorsal aspect; C, ventral aspect. Scales indicate 10 mm.

form a independent muscular mass.

Levator internus (LI): There are two elements of the levator internus. They originate from the lateral side of the cranium medial to originations of the levatores externi, and insert to the dorsal face of the pharyngobranchial. They are separated by interposition of the transversus dorsalis anterior.

Levator posterior (LP): This muscle originates from the intercalar or the ventrolateral face of the pterotic, and inserts at the fourth epibranchial just above the articulation to the fourth ceratobranchial.

Transversus dorsalis (TD): This muscle is the largest mass in the dorsal elements of the branchial muscles, and is classified into the anterior and the posterior elements. The transversus dorsalis anterior lies on the superficial surface of the dorsal elements of the branchial muscles. This muscle originates from the dorsal surface of the second epibranchial, and fuses with its antimere on the dorsal midline by a median raphe. This muscle is tendinously connected with the pharyngobranchial anterolaterally. In *Hemitripterus villosus*, the transversus dorsalis anterior inserts not only to the second epibranchial but also to the third epibranchial (Fig. 39, A). The transversus dorsalis posterior lies under the obliquus dorsalis. This muscle extends to the area between the third and the fourth the epibranchials on each side.

Obliquus dorsalis (OD): This muscle is sandwiched by the transversus dorsalis

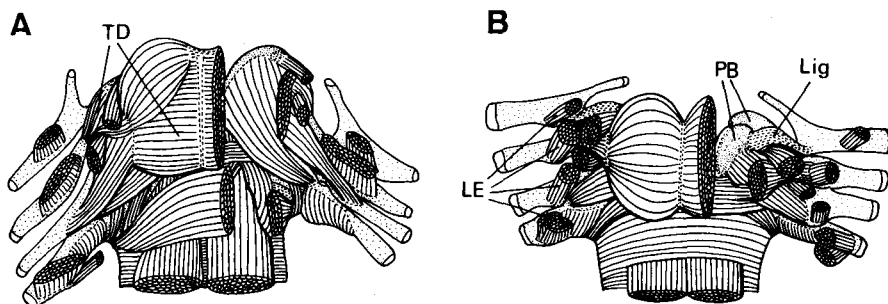

Fig. 39. Muscles serving to the dorsal surface of the branchial arch. A, *Hemitripterus villosus*; B, *Hexagrammos stelleri*. Lig, ligament; PB, pharyngobranchial. For other abbreviations, see Fig. 38. Scales indicate 10 mm.

anterior and posterior. This muscle originates from the dorsal surface of the pharyngobranchial and inserts to the articular position between the third and the fourth epibranchials.

Obliquus posterior (OP): This muscle originates from the dorsal surface of the fourth epibranchial and inserts the posterior margin of the fifth ceratobranchial.

Retractor dorsalis (RD): This paired muscle originates from the posterior margin of the pharyngobranchial and inserts at the ventral surface of the anterior centra.

Rectus ventralis (RV, RVu): This muscle contains two kinds of muscular series. The first (RV) is the muscular series interconnecting the hypobranchial and/or the ceratobranchial of one branchial arch and those of the preceding arch. All cottoid fishes examined are possessed of the rectus ventralis III which interconnects the third hypobranchial and the fourth ceratobranchial. Some medial fibers of the rectus ventralis III insert to the transversus ligament between the third hypobranchial on each side. In addition to the rectus ventralis III, the agonid fishes are possessed of the rectus ventralis II which is situated between the second hypobranchial and the third hypobranchial. The second series (RVu) is the muscle interconnecting the third hypobranchial and the urohyal. This muscle is present in the all cottoid fishes except for the ereuniid and rhamphocottid fishes.

Obliquus ventralis (OV): This muscle is situated on the ventral surface between the hypobranchial and the ceratobranchial of the same branchial arch. This muscle is present on the anterior three branchial arch in the cottoid fishes.

Transversus ventralis (TV): This muscle spans the midline between the ventromedial faces of the ceratobranchials. In the cottoid fishes, there are two transversi ventrales which are connected with the fourth and the fifth pairs of the ceratobranchials respectively.

Rectus communis (RC): This muscle originates from the posterolateral surface of the urohyal and inserts to the ventrolateral surface of the fifth ceratobranchial tendinously.

Adductor (AD): This muscle interconnects the epibranchial and the ceratobranchial. All cottoid fishes are possessed of the adductor V which originates

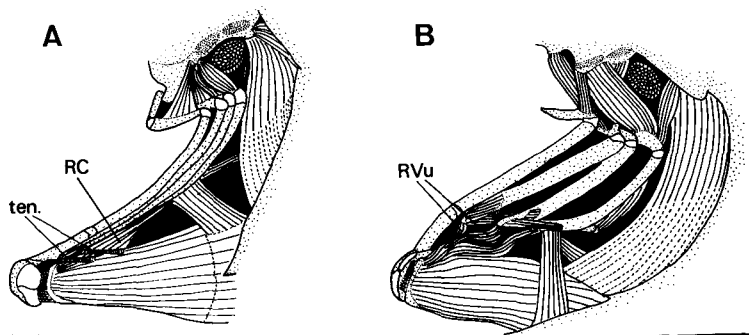

Fig. 40. Muscles serving to lateral surface of the branchial arch. A, *Minous monodactylus*; B, *Liparis tessellatus*. For abbreviations, see Fig. 38. Scales indicate 10 mm.

from the posterolateral margin of the fourth epibranchial and from the posteromedial margin of the fourth ceratobranchial, and inserts to the posterodorsal tip of the fifth ceratobranchial. This muscle is converged to the obliquus posterior medially.

Pharyngoclavicularis (PHE, PHI): There are two elements of this muscle. The pharyngoclavicularis externus (PHE) originates from the anterior tip of the horizontal arm of the cleithrum, and passes dorsally to insert to the ventrolateral margin of the fifth ceratobranchial. The pharyngoclavicularis internus (PHI) tendinously originates from the anteromedial surface of the cleithrum and inserts to the ventral face of the fifth ceratobranchial. The insertion of the pharyngoclavicularis internus is anteromedial to that of the pharyngoclavicularis externus.

SCORPAENIFORM FISHES: The conditions of the branchial muscles except for the levator externus, the pharyngoclavicularis and the rectus ventralis are almost the same as those observed in the cottoid fishes examined.

Levator externus (LE): Four pairs of the levatores externi are present in the most of the scorpaeniform fishes examined. They share a common originating position on the prootic and are separated into four heads inserting to each epibranchial. In *Inimicus*, *Eumicrotremus*, *Aptocyclus* and *Liparis*, the levator externus III is absent.

Rectus ventralis (RV, RVu): All scorpaeniform fishes are possessed of the rectus ventralis III. A liparidid fish, *Liparis tessellatus*, has well developed recti ventrales I-III. In the cyclopterid fishes *Eumicrotremus* and *Aptocyclus*, there is no rectus ventralis. But they are possessed of ligamentous tissue which joints among each hypobranchial. The rectus ventralis interconnecting the urohyal and the third hypobranchial is absent in all scorpaeniform fishes examined except for *Liparis tessellatus* in which the rectus ventralis originates from the urohyal and inserts to the second and the third hypobranchials.

Pharyngoclavicularis (PH): In most of the scorpaeniform fishes except for the cyclopterid and liparidid fishes, the pharyngoclavicularis externus and internus interconnect the fifth ceratobranchial and the cleithrum. In the cyclopterid and the liparidid fishes, the pharyngoclavicularis externus originates from the ventrolateral

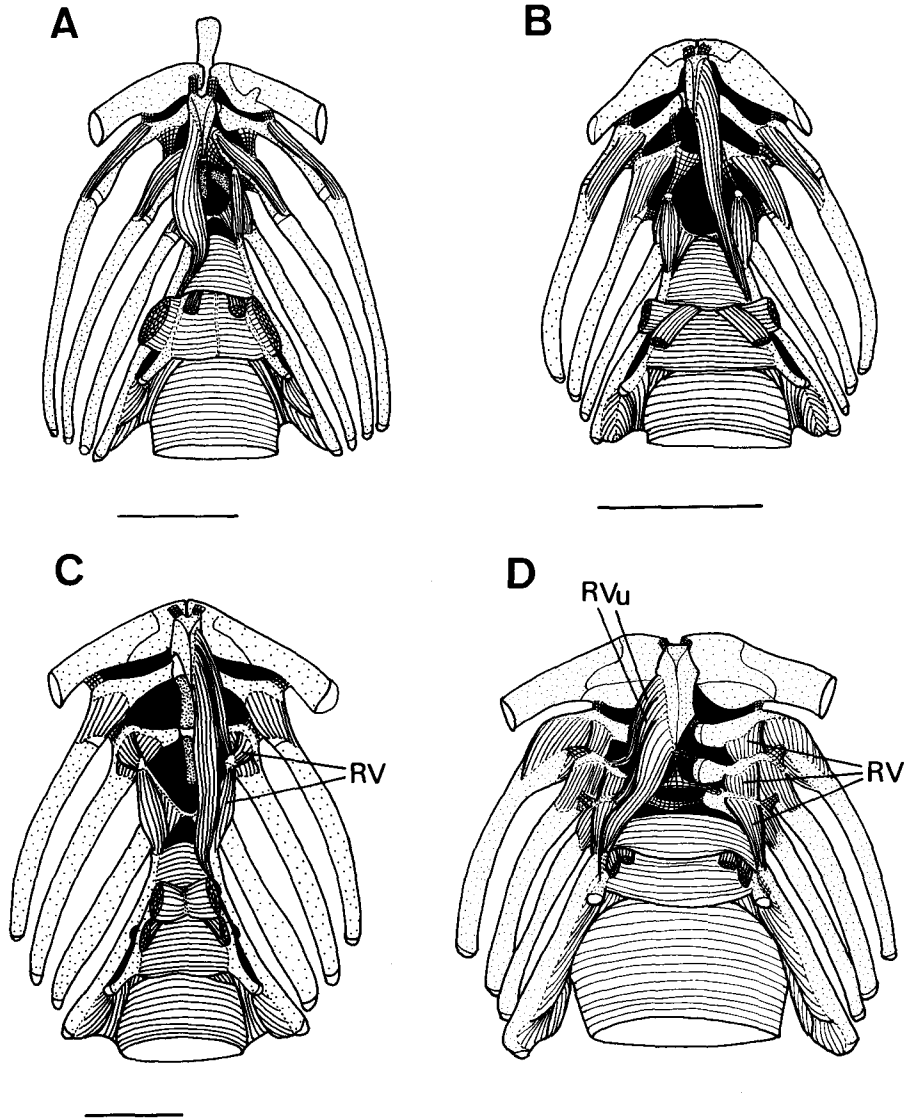

Fig. 41. Muscles serving to the ventral surface of the branchial arch. A, *Helicolenus hilgendorfi*; B, *Marukawichthys ambulator*; C, *Podothecus sachi*; D, *Liparis tessellatus*. For abbreviations, see Fig. 38. Scales indicate 10 mm.

margin of the cleithrum, while the pharyngoclavicularis internus is from the dorsal tip of the suprapelvic process of the pelvis.

Discussion. The branchial muscles of some cottoid fishes and other scorpaeniform fishes have been described by Dietz (1914). But the branchial muscles of these groups have not been fully clarified. In the present study, it is observed that the insertion of the transversus dorsalis anterior, the number of the recti ventrales

and the condition of the rectus ventralis interconnecting the urohyal and the third hypobranchial are changed among the cottoid fishes examined. In addition to these characters, it is confirmed that the number of the levatores externi and the insertion of the pharyngoclavicularis internus are uniform in the cottoid fishes, but they are changed among the scorpaeniform fishes.

Insertion of the transversus dorsalis anterior: In the cottoid fishes examined, two conditions of this character are observed. Type A has the transversus dorsalis anterior inserting to the second epibranchial. The most of the cottoid fishes are included in this type. Type B has the muscle inserting to the second and the third epibranchials. This type includes only *Hemitripterus villosus*. In the generalized percoid fishes, this muscle inserts only to the second epibranchial (Liem, 1970; Harder, 1975; Freihofer, 1978). It, therefore, is considered that type A of the cottoid fishes is the primitive condition, and type B is the derived condition in the cottoid fishes. On the other hand, the all scorpaeniform fishes examined here have the type A of the transversus dorsalis anterior. Thus, it is regarded that the type B observed in *Hemitripterus* is the unique and derived condition among the cottoid fishes and other scorpaeniform fishes.

Number of the recti ventrales: In the cottoid fishes examined, there are two types of this character. Type A is defined by having only the rectus ventralis III and observed in the fishes of the families Rhamphocottidae, Ereuniidae, Psychrolutidae, Hemitripteridae and Cottidae. Type B is defined by having the rectus ventralis II and III, and observed in the agonid fishes. As regarding this character, there are few data in the generalized percoid fishes, but the similar condition to the type A in the cottid fishes has been observed in *Epinephelus* (Nelson, 1967). Moreover, the type A of the cottoid fishes has been observed in various teleostean fishes (Dietz, 1914; Nelson, 1967; Liem, 1970; Winterbottom, 1974a; Harder, 1975), and regarded as the typical condition of the rectus ventralis in the perciform fishes (Harder, 1975). It, therefore, is considered that type A of this character is primitive, and type B is the derived condition in the cottoid fishes. Among the other scorpaeniform fishes examined, the type A of the cottoid fishes is observed in the scorpaenid, synanceiid, platycephalid, triglid, anoplomatid, hexagrammid, and zaniolepidid fishes. In the liparidid fishes, the rectus ventralis I, II and III are observed. The cyclopterid representatives are not possessed of the muscular mass of the rectus ventralis, but ligamentous tissue interconnects each branchial arch.

Condition of the rectus ventralis interconnecting the urohyal and the third hypobranchial: This muscle has been recorded only in *Cottus scorpius* (= *Myoxocephalus scorpius*) by Dietz (1914). In the present study, it is confirmed that this muscle is present in the cottid, psychrolutid, hemitripterid and agonid fishes, but absent in the rhamphocottid and ereuniid fishes. In the generalized percoid fishes, this muscle has not been reported (Nelson, 1967; Osse, 1969; Winterbottom, 1974a; Elshould-Oldenhave and Osse, 1976). In the one of the generalized percoid fishes, *Perca fluviatilis*, a flat broad ligament interconnects the urohyal and the third hypobranchial, but there is no muscle between them (Osse, 1969). It, therefore, is considered that the absence of this muscle is the primitive and the presence of this muscle is the derived condition in the cottoid fishes. Among the other

scorpaeniform fishes examined here, the primitive condition of this character is observed in the scorpaenoid, platycephalid, triglid, anoplopomatid, zaniolepidid, hexagrammid and cyclopterid fishes. The liparidid representative has the recti ventrales extending from the urohyal to the second and the third hypobranchials. It is regarded as the highly specialized condition of this character.

Number of levatores externi: The cottoid fishes have the levator externus I, II and IV, and do not have the levator externus III. In some of the cottoid fishes, a few muscular fibers of the levator externus IV extend to the third epibranchial, but they do not form the independent muscular mass. In the generalized percoid fishes, there are four levatores externi (I-IV). The levator externus III is present as a distinct muscular mass (Dietz, 1914a; Liem, 1970; Winterbottom, 1974a; Freihofer, 1978). It has been reported that the levator externus III is commonly absent in the specialized acanthopterygian fishes (Field, 1966; Winterbottom, 1974a; Harder, 1975). It, therefore, is considered that the absence of the levator externus III is derived condition of the cottoid fishes in comparison with the condition of the generalized percoid fishes. Among the other scorpaeniform fishes examined, the synanceiid, cyclopterid and liparidid fishes have the condition of the cottoid type, while the scorpaenid, platycephalid, triglid, anoplopomatid, zaniolepidid and hexagrammid fishes have that of the generalized percoid type.

Insertion of pharyngoclavicularis internus: In all cottoid fishes, the pharyngoclavicularis internus inserts to the cleithrum. This condition has been described in the various teleostean groups including the generalized percoid fishes (Dietz, 1914; Takahashi, 1925; Holstvoogd, 1965; Nelson, 1967; Greenwood, 1971; Liem, 1970, 1978 and 1981; Winterbottom, 1974a, b). Most scorpaeniform fishes examined have the same condition of this character as that in the cottoid fishes. In the cyclopterid and liparidid fishes, the pharyngoclavicularis internus inserts to the suprapelvic process of the pelvis. It is regarded as the unique and derived condition of this character of the cyclopterid and liparidid fishes. Regarding to this character, the all cottoid fishes have primitive condition in comparison with the cyclopterid and liparidid fishes.

4. MUSCLES SERVING THE PECTORAL FIN (Figs. 42-44)

Description

COTTOID FISHES: The pectoral fin is supported by three muscles laterally; the abductor superficialis, the abductor profundus, the arrector ventralis, and by five muscles medially; the adductor superficialis, the adductor profundus, the arrector dorsalis, the adductor radialis and the coracoradialis.

Abductor superficialis (ABS): This muscle forms the superficial division of the muscular mass serving the pectoral fin. This muscle originates from the posterior face of the lateral flange of the cleithrum and inserts to the dorsolateral base of the lateral half of the each pectoral fin ray except for the uppermost ray. The insertion of this muscle serving lower rays is tendinous. In ereuniid fishes, the abductor superficialis inserting to the free rays is well developed and forms the independent muscular mass separated from the mass inserting the upper lob of the pectoral fin (Fig. 43).

Abductor profundus (ABP): The position of this muscle is deep to the

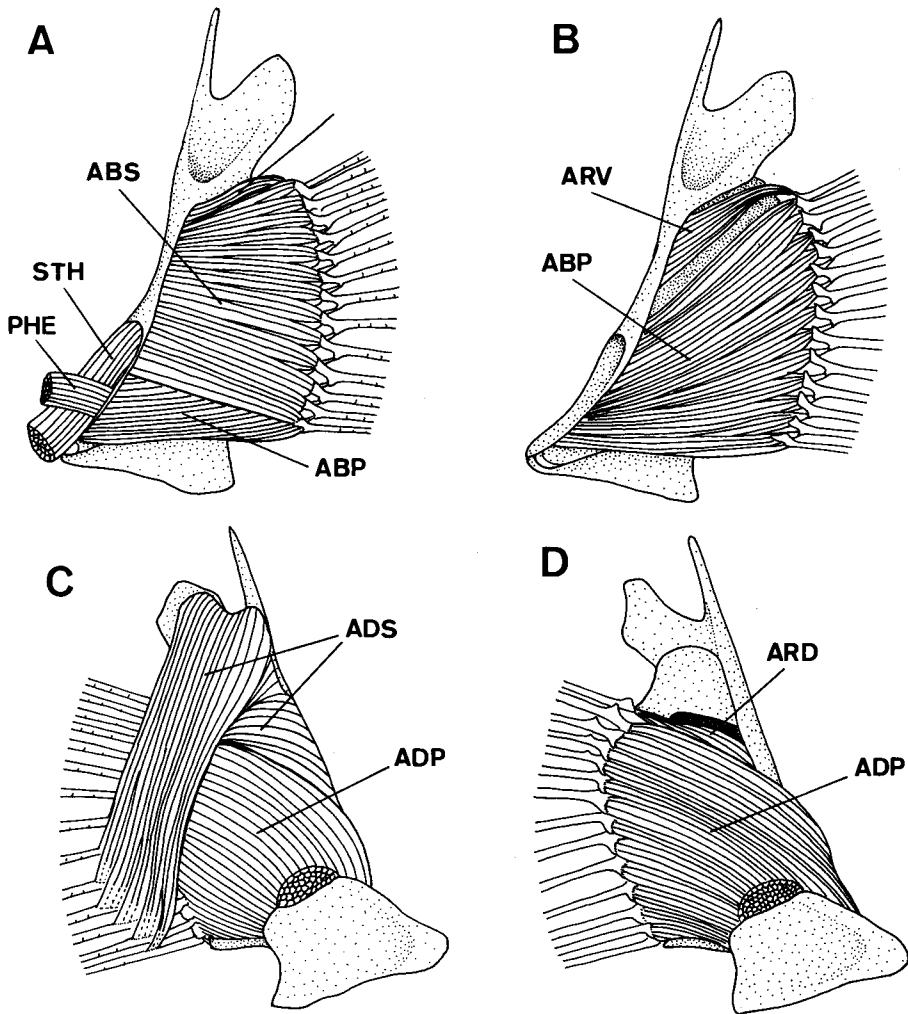

Fig. 42. Pectoral muscles of a cottid fish, *Vellitor centropomus*. A, superficial musculature of the lateral aspect; B, after removal of the abductor superficialis; C, superficial musculature of medial aspect; D, after removal of the adductor superficialis. ABP, abductor profundus; ABS, abductor superficialis; ADP, adductor profundus; ADS, adductor superficialis; ARD, arrector dorsalis; ARV, arrector ventralis; PHE, pharyngoclavicularis externus; STH, sternohyoideus.

abductor superficialis. This muscle originates from the lateral surfaces of the coracoid and the scapula, and from the posterior surface of the lateral flange of the cleithrum, and it inserts to the anteroventral base of the lateral half of each pectoral fin ray.

Arrector ventralis (ARV): The position of this muscle is deep to the abductor superficialis and is dorsal to the abductor profundus. This muscle originates from the posterior surface of anterolateral flange of the cleithrum, and inserts to the

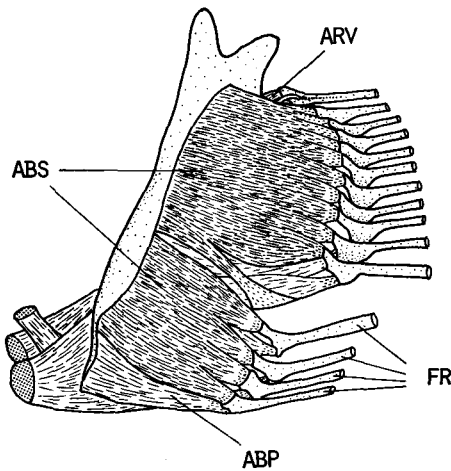

Fig. 43. Lateral aspect of the pectoral muscles in *Ereunias grillator*. FR, free ray. For other abbreviations, see Fig. 42. Scale indicates 10 mm.

anteromedial base of the medial half of the first pectoral fin tendinously.

Adductor superficialis (ADS): This muscle forms the superficial division of the muscular masses serving to the medial face of the pectoral fin. This muscle originates from the dorsomedial face of the cleithrum and tendinously inserts to the dorsal bases of the medial half of each pectoral fin ray except for the uppermost.

Adductor profundus (ADP): This muscle covers a wide area of the medial face of the pectoral girdle and is situated on deep and ventral position. This muscle inserts to the ventral base of the medial half of the pectoral fin ray except for the uppermost.

Arrector dorsalis (ARD): This muscle originates from the medial face of the scapula and the cleithrum and inserts to the ventral base of the medial half of the first ray of the pectoral fin.

Adductor radialis: This muscle originates from the medial surface of the actinosts and inserts to the ventral base of the medial half of some lower rays of the pectoral fin. On the upper part of the pectoral girdle, the separation between the adductor radialis and the adductor profundus is obscure.

Coracoradialis (COR): A tiny muscular sheet of this muscle is present in the psychrolutid fishes. In these fishes, the muscle is situated on the narrow space between the lowermost actinost and the coracoid. In the other cottoid fishes, this muscle is well reduced or absent. If it is present, only a few muscular fibers are observed but they do not form a muscular sheet.

SCORPAENIFORM FISHES: Among the scorpaeniform fishes examined, the triglid fishes which have a few free pectoral rays possess the unique muscular pattern of the pectoral fin. In the triglid fishes, the abductor superficialis, the adductor superficialis and the adductor profundus inserting to the free rays are well developed and form independent muscular masses separated from the masses inserting to the other fin rays. The adductor superficialis is highly modified. The muscular mass of this muscle inserting to each free ray possesses two inserting heads. One of them inserts to the dorsal process of the medial half of each free ray by a long tendon, while the another head inserts to the dorsomedial surface of each free ray just distal to the dorsal process. In the other scorpaenifor fishes examined, the muscular pattern of the pectoral fin is almost as same as that observed in the cottoid fishes, but the distinct difference is observed in the condition of the coracoradialis.

Coracoradialis (CO): This muscle is present in all scorpaeniform fishes examined except for the cyclopterid and liparidid fishes. In the scorpaenid, synanceiid, bembroid and triglid fishes, this muscle is well developed, and situated between

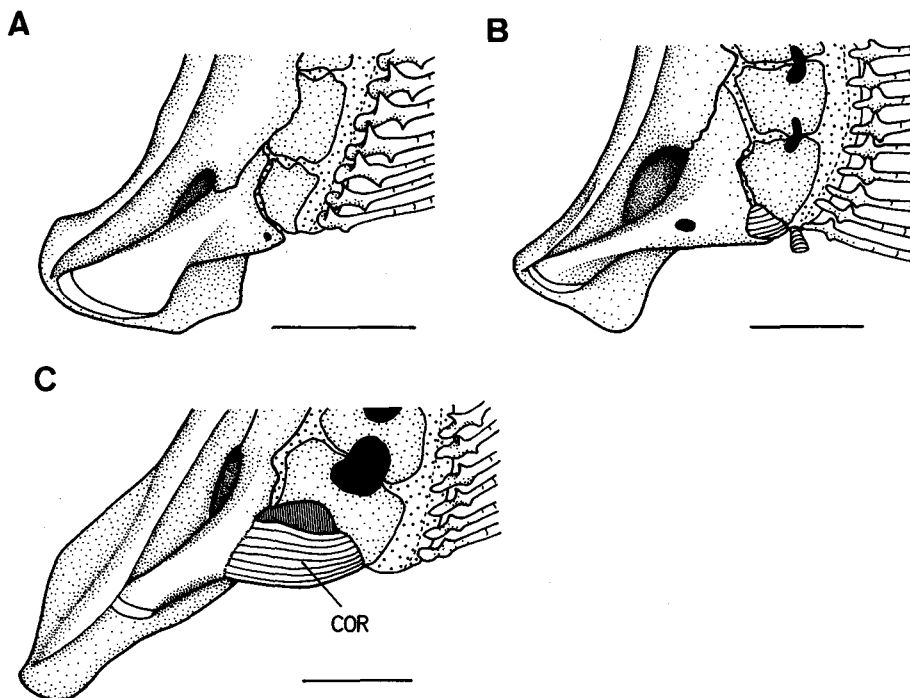

Fig. 44. The coracoradialis (COR) in three scorpaeniform fishes. A, *Scorpaenichthys marmoratus* (Cottidae; COR is absent); B, *Hexagrammos stelleri* (Hexagrammidae); C, *Pterois lunulata* (Scorpaenidae). Scales indicate 10 mm.

ventral margin of the lowermost actinost and the postcoracoid process of the coracoid (Fig. 44, C). In platycephalid, hexagrammid, anoplomatid and zaniolepidid fishes, this muscle is present but rather reduced and situated at the narrow interspace between the posterior tip of the coracoid and the posteroventral margin of the lowermost actinost (Fig. 44, B).

Discussion. The pectoral muscles of the cottoid and the scorpaeniform fishes have been described by Rendahl (1934), and Ganguly and Majumdar (1963). But they examined a few representatives. In the present study, it is clarified that the conditions of the abductor superficialis and the coracoradialis are changed among the cottoid fishes.

Condition of abductor superficialis: In the ereuniid fishes, the abductor superficialis serving the free pectoral rays is well developed and forms a separated muscular mass from the upper. This condition has not been reported from the generalized percoid fishes (Rendahl, 1934; Winterbottom, 1974a; Geerlink, 1979). Thus this condition is regarded as the derived condition in the cottoid fishes. On the other hand, the triglid fishes have the abductor superficialis which is similar to the ereuniid type. In these fishes, the adductor superficialis interting the free ray is also highly specialized. Such a specialization is not observed in the ereuniid fishes.

Condition of the coracoradialis: Among the cottoid fishes, the psychrolutid

fishes have this muscle which is present as a small muscular sheet. In the other cottoid fishes, the coracoradialis is absent or obscure. In the generalized percoid fishes, the coracoradialis has been described as a developed muscular mass interconnecting the lowermost actinost and the postcoracoid process. It, therefore, is considered that the presence of this muscle is primitive in the cottoid fishes, but the condition in the psychrolutid fishes is more derived in comparison with the generalized percoid fishes, because the muscle in the former is more reduced than that of the latter. Among the other scorpaeniform fishes examined, this muscle is present as more or less developed muscular mass in the scorpaenid, triglid, platycephalid, anoplopomatid, hexagrammid and zaniolepidid fishes, while it is absent in the cyclopterid and liparidid fishes.

5. MUSCLES SERVING THE PELVIC FIN (Figs. 45-47)

Description

COTTOID FISHES: On the pelvic girdle, there are three muscles ventrally; the arrector ventralis pelvicius, the abductor superficialis pelvicius and the abductor profundus pelvicius; one muscle, the arrector dorsalis pelvicius, laterally; and two muscles dorsally; the adductor superficialis and the adductor profundus. The extensor proprius is absent in all cottoid fishes examined. A strong ligament is present between ventromedial tip of pelvic fin rays and postpelvic process.

Arrector ventralis pelvicius (ARV): This muscle originates from the lateral margin of the ventral surface of the pelvis and inserts to the ventromedial point of the base of the pelvic spine by means of a strong tendon.

Abductor superficialis pelvicius (ABS): This muscle originates from the anter-ventral surface of the pelvic and from the lateral margin of the subpelvic process, and inserts to the ventromedial corner of all pelvic fin rays. Anteriorly this muscle is connected with the infracarinalis anterior by means of the myocomma. In

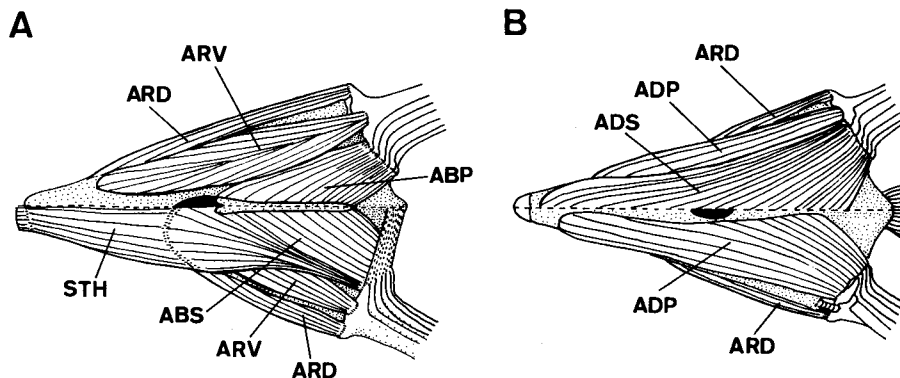

Fig. 45. Musculature of the pelvic girdle in a cottid fish, *Jordania zonope*. A, ventral view (upper half, after removal of ABS and STH); B, medial view (lower half, after removal of ADS). ABP, abductor profundus pelvicius; ABS, abductor superficialis pelvicius; ADP, adductor profundus pelvicius; ADS, adductor superficialis pelvicius; ARD, arrector dorsalis pelvicius; ARV, arrector ventralis pelvicius; STH, sternohyoideus.

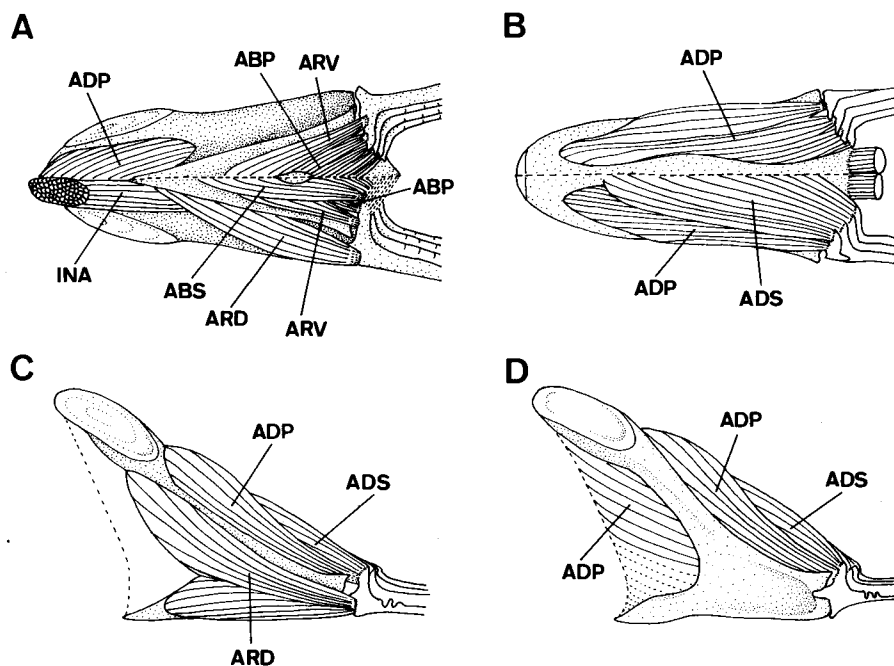

Fig. 46. Musculature of the pelvic girdle of *Rhamphocottus richardsoni*. A, ventral aspect; B, medial aspect; C, lateral aspect; D, lateral aspect after removal of ARD. For abbreviation, see Fig. 45.

Rhamphocottus, this muscle passes through the median pore of the pelvis and extends anteriorly to reach anteroventral surface of the pelvis (Fig. 46).

Abductor profundus pelvici (ABP): This muscle is covered with the abductor superficialis pelvici. Its origin from the ventral surface of the pelvis is more posteromedial to that of the arrector ventralis pelvici. This muscle inserts to the ventromedial corner of all pelvic fin rays somewhat lateral to the position of the abductor profundus pelvici. In *Rhamphocottus*, this muscle is converged with the abductor profundus pelvici anteriorly and passes through the median pore to reach anteroventral face of the pelvis.

Arrector dorsalis pelvici (ARD): This muscle originates from the posterolateral surface of the pelvis and inserts to the lateral tip of the base of the pelvic spine by means of a strong tendon.

Adductor superficialis pelvici (ADS): This muscle originates from the median region of the dorsal surface of the pelvis, and inserts to the dorsomedial processes of the pelvic spine and soft rays.

Adductor profundus pelvici (ADP): This muscle originates from somewhat lateral region of the dorsal surface of the pelvis, and inserts to the dorsolateral corner of the soft rays of the pelvic fin.

The fishes of the genera *Ereunias* and *Ascelichthys* have no fin ray elements or only a rudimentary spine. These fishes do not have the muscles described above.

SCORPAENIFORM FISHES: Six muscles observed in the cottoid fishes are also

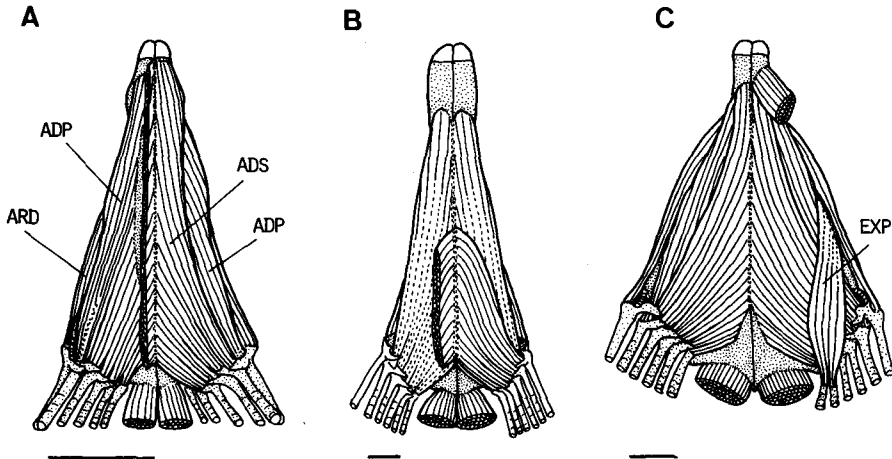

Fig. 47. Musculature of the medial aspect of the pelvic girdle in three scorpaeniform fishes. A, *Jordania zonope* (Cottidae); B, *Hexagrammos stelleri* (Hexagrammidae); C, *Zaniolepis frenata* (Zaniolepididae). EXP, extensor proprius; for other abbreviations, see Fig. 45. Scales indicate 2 mm.

present in the other scorpaeniform fishes examined here. Their conditions are almost the same as those in the cottoid fishes. In addition to these muscles, many scorpaeniform fishes possess the extensor proprius.

Extensor proprius (EXP): This muscle is the most dorsal section of the muscles serving the dorsal surface of the pelvic fin. It lies above the adductor superficialis pelvicius. This muscle originates from the dorsolateral margin of the pelvis and runs posteromedially to converge on one or a few tendons that insert on one or a few inner soft rays. This muscle is absent in the hexagrammid, cyclopterid and liparidid fishes.

Discussion. The pelvic muscle of the cottoid fishes and other scorpaeniform fishes have not been examined. The most of cottoid fishes are possessed of the muscular pattern similar to that of the generalized percoid fishes except for a few aspects. It is clarified that the extensor proprius is absent in all cottoid fishes, but its distributional pattern is changed among the scorpaeniform fishes.

Condition of the extensor proprius: In the cottoid fishes examined here, the extensor proprius is absent. According to Winterbottom (1974a), the distribution of this muscle among the teleostean fishes has not been well known, but this muscle has been reported from a percoid genus *Perca*. Judging from this limited knowledge, it is considered that the presence of the extensor proprius is the primitive condition in the scorpaeniform fishes. Thus, it is regarded that the cottoid fishes share the derived condition of this character. Among the other scorpaeniform fishes examined, this muscle is present in the scorpaenid, platycephalid, triglid, anoplomatid and zaniolepidid fishes, while it is absent in the hexagrammid, cyclopterid and liparidid fishes.

6. BODY MUSCLE (Figs. 48 and 49)

Description

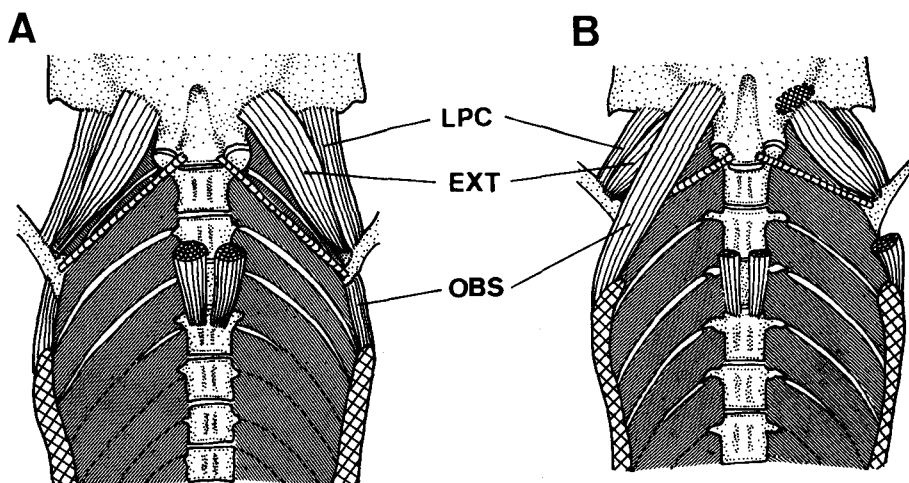

Fig. 48. Condition of the extrinsic muscle (EXT) and the obliquus superioris (OBS) of two cottid fishes. A, *Triglops septicus*; B, *Jordania zonope*. LPC, levator pectoralis.

COTTOID FISHES: The body muscles are separated into two major divisions; the epaxialis and the hypaxialis. The hypaxialis is subdivided into two sections; the obliquus superioris and the obliquus inferioris. The lateralis superficialis is not developed.

Epaxialis (EP): The epaxialis is the dorsal component of the body muscle lying above the lateral septum. This muscle possesses two inserting heads, dorsomedian head and lateral head, anteriorly. The dorsomedian head inserts to the posterodorsal margin of the cranium (the parietal, the supraoccipital, the exoccipital and the anterodorsal process of the posttemporal), and does not extend to the dorsal surface of the occipital region. The lateral head inserts to the posterior margin of the dorsolateral region of the exoccipital in many cottoid fishes. In the fishes of the genera *Jordania*, *Marukawichtys*, *Ereunias*, *Cottus* and *Scorpaenichthys*, some fibers of this muscle extend forward and insert to the posttemporal fossa.

Obliquus superioris (OBS): The obliquus superioris is a subdivision of the hypaxialis, and lies just below the midline of the body. Its fibers pass from anterodorsal to posteroventral. This subdivision is poorly developed anteriorly, but forms the main mass of the hypaxialis posteriorly. In all cottoid fishes except for *Jordania zonope*, this subdivision inserts to the medial surface of the posterodorsal process of the cleithrum (Fig. 48, A). In *Jordania zonope*, this subdivision extends to the posteroventral region of the cranium, and attaches to the posterolateral face of the basioccipital (Fig. 48, B). The Baudelot's ligament is free from this subdivision in all cottoid fishes.

Obliquus inferioris: This subdivision of the hypaxialis lies ventrolateral region of the body and covers ventrolateral face of the abdominal cavity anteriorly. Anterodorsal part of this subdivision grades into the tissue of the wall of abdominal cavity and extends to the posterior margin of the cleithrum. Main mass of this

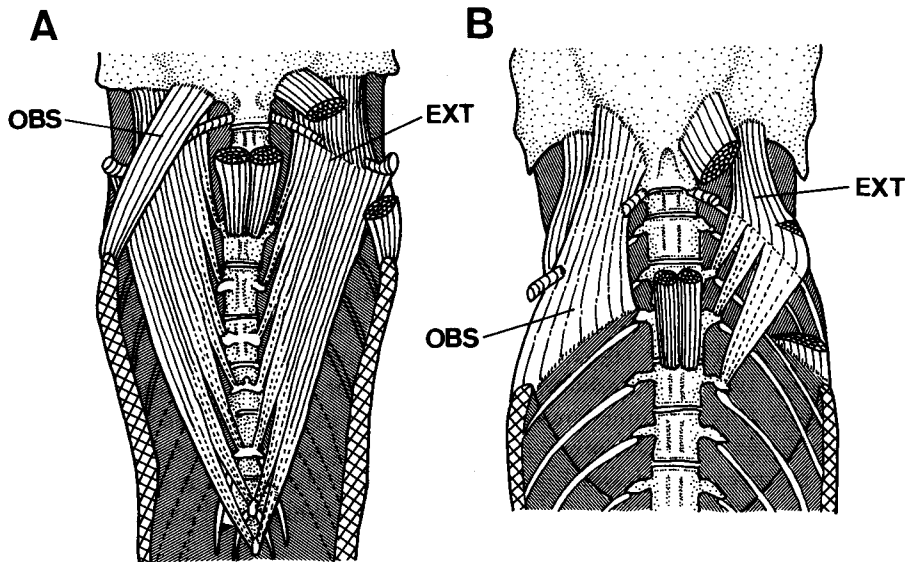

Fig. 49. Condition of the extrinsic muscle and the obliquus superioris in two scorpaeniform fishes. A, *Hypodytes rubrinus*; B, *Zaniolepis latipinnis*. For abbreviation, see Fig. 48.

subdivision attaches to the ventral foot of the cleithrum and to the coracoid. The ventrolateral fibers are continuous with the posterior region of the sternohyoideus. Posteriorly, this subdivision is reduced and passes medial to the inclinator analis.

SCORPAENIFORM FISHES: In the scorpaeniform fishes examined, the epaxialis and two subdivisions of the hypaxialis are present. The lateralis superficialis is not developed.

Epaxialis: This muscle is possessed of two inserting heads anteriorly. The lateral head is well developed and inserts to the posttemporal fossa anteriorly. In hexagrammid, zaniolepidid and anoplomatid fishes, it is well developed and extends to the dorsolateral region of the cranium just above the posterior margin of the orbit. In the cyclopteroid fishes, the lateral head of the epaxialis is not developed and stopped at the posterior margin of the dorsolateral region of the exoccipital. The dorsomedian head of the epaxialis usually inserts to the posterodorsal margin of the cranium. It extends to the posterodorsal face of the cranium in hexagrammid fishes. In liparidid and cyclopterid fishes, it extends to the dorsal surface of the cranium just above to the middle of the orbit.

Obliquus superioris (OBS): This subdivision of the hypaxialis usually inserts to the basioccipital region of the cranium anteriorly and is penetrated or connected with the Baudelot's ligament (Fig. 49). In the cyclopterid fishes, this subdivision attaches to the posterodorsal surface of the cleithrum and is free from the Baudelot's ligament.

Obliquus inferioris: This subdivision of the hypaxialis lies ventrolateral region of the body and covers ventrolateral surface of the abdominal cavity anteriorly. The anterior fibers inserts to the posterior margin of the cleithrum.

Ventrolateral fibers pass lateral to the cleithral foot and are continued to the posterior region of the sternohyoideus.

Discussion. In the cottoid fishes and other scorpaeniform fishes, the body muscles have not been examined yet. As the result of the comparative anatomy in the present study, it is confirmed that the condition of the obliquus superioris is changed within the cottoid fishes.

Insertion of the obliquus superioris: There are two conditions in this character. Type A is characterized by having the obliquus superioris which inserts to the posteroventral surface of the cranium. This type includes *Jordania zonupe*. Type B including the most of the cottoid fishes is characterized by having the obliquus superioris which inserts to the posterodorsal process of the cleithrum. In the generalized percoid fishes, the distribution of this muscle shows type A of the cottoid fishes (Gosline, 1966; Winterbottom, 1974a; Harder, 1975). It, therefore, is considered that type A is the primitive condition, and type B is the derived condition in the cottoid fishes. On the other hand, other scorpaeniform fishes examined here except for the cyclopterid and liparidid fishes have the obliquus superioris of type A in the cottoid fishes. Type B is observed in the cyclopterid and liparidid fishes.

7. MUSCLES SERVING THE CAUDAL FIN (Fig. 50)

Description.

COTTOID FISHES: The caudal fin is served by seven muscular elements; the interradialis, the hypochordal longitudinalis, the flexor dorsalis superior, the flexor dorsalis, the flexor ventralis, the flexor ventralis externus and the flexor ventralis inferior. In addition to these muscles, the posterior ends of the epaxialis and the hypaxialis insert to the bases of the caudal fin rays. The adductor dorsalis is absent in all cottoid fishes examined.

Interradialis (INT): This muscle consists of a number of bundles of muscular fibers interconnecting the principal caudal fin rays. This muscle lies mainly between the adjacent rays, but often extends over more than one ray. The muscular fibers serving to the upper half of the caudal fin pass upwards and backwards, while the fibers serving to lower half of the caudal fin pass downwards and backwards. Basal part of the bundle serving to the uppermost ray of the lower half of the caudal fin lies under the bundle serving to the lowermost ray of the upper half.

Hypochordal longitudinalis (HL): This muscle originates from the dorsolateral surface of the lower hypural complex and inserts to the upper two or three principal rays of the upper half of the caudal fin by strong tendons.

Flexor dorsalis superior (FDS): This muscle originates from the posterior a few centra and the epurals, and inserts to the posterior some procurrent rays of the dorsal series and upper one or two principal caudal rays.

Flexor dorsalis (FD): This muscle originates from the dorsolateral surface of the posterior a few centra and upper hypural complex and inserts to the bases of the principal rays of the upper half of the caudal fin.

Flexor ventralis externus (FVE): This muscle originates from the ventrolateral surface of the centra and haemal spines of posterior some vertebrae. It runs posterodorsally and converges on a thin tendinous tissue to insert upper a few rays of the lower lobe of the caudal fin.

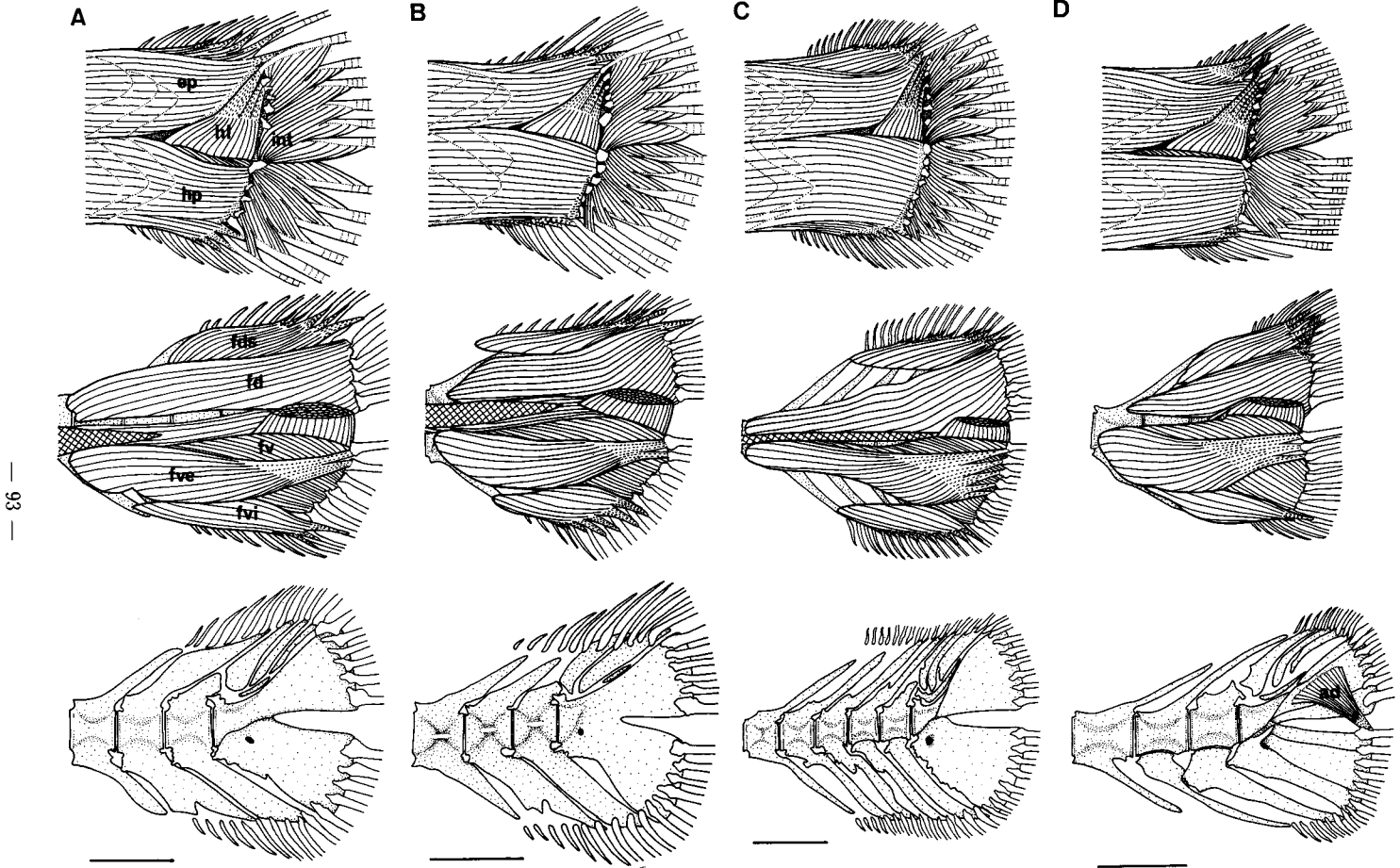

Fig. 50. The muscles serving to the caudal fin (above, superficial layer; Middle, profound layer; below, caudal skeleton). A, *Hemilepidotus gilberti*; B, *Trachidermus fasciatus*; C, *Hexagrammos stelleri*; D, *Setarches longimanus*. ad, adductor dorsalis; ep, epaxialis; fd, flexor dorsalis; fds, flexor dorsalis superior; fv, flexor ventralis; fve, flexor ventralis externus; fvi, flexor ventralis inferior; hl, hypochordal longitudinalis; hp, hypaxialis; int, interradians. Scales indicate 5 mm.

Flexor ventralis (FV): This muscle originates from the lateral surface of the haemal spines, ventrolateral surface of the posterior a few centra and the lower hypural complex. Insertion of this muscle is lateral bases of the principal caudal fin rays of the lower half.

Flexor ventralis inferior (FVI): This muscle originates from distal parts of the haemal spines of the posterior a few vertebrae, and inserts to some posterior procurent rays of the ventral series and lower principal rays by strong tendons.

SCORPAENIFORM FISHES: The scorpaeniform fishes examined here are also possessed of seven muscular elements observed in the cottoid fishes. In addition to these elements, many scorpaeniform fishes are possessed of the adductor dorsalis.

Adductor dorsalis (AD): This muscle originates from the lateral surface of the upper hypural complex and inserts to the base of the uppermost ray of the lower half of the caudal fin. This muscle is present in the scorpaenid, platycephalid, and bembroid fishes. Other scorpaeniform fishes examined here are not possessed of this muscle.

Discussion. Among the scorpaeniform fishes, the caudal muscles have been described only on the genera *Myoxocephalus* (Cowan, 1969) and *Sebastes* (Rybachuk, 1976). The difference of the caudal muscles among the cottoid fishes and other scorpaeniform fishes have not be clarified in these studies. As the result of the comparison of the caudal muscles in the present study, the distinct difference is found in the condition of the adductor dorsalis. All cottoid fishes examined here do not have the adductor dorsalis. In the percoid fishes, the presence of this muscle has been reported from the lutjanid, kuhlid, apogonid and centrarchid fishes (Narshall, 1963; Nag, 1969; Winterbottom, 1974a). It, therefore, is considered that the presence of this muscle is the primitive condition for the scorpaeniform fishes. In this sense, the cottoid fishes share the derived condition of this character. Among the other scorpaeniform fishes examined, this muscle is present in the scorpaenid, platycephalid representatives, while it is absent in the triglid, synanceiid, anoplomatid, hexagrammid, zaniolepidid, cyclopterid and liparidid fishes.

8. MUSCLES OF THE SWIMBLADDER (Figs. 48, 49 and 51; Table 11)

Description

COTTOID FISHES: In the cottoid fishes, the extrinsic muscle is present, but the intrinsic muscle is absent.

Extrinsic muscle (EXT): In the cottoid fishes, the swimbladder is absent, but the extrinsic muscle is well developed. This muscle originates from the posteroventral surface of the otolith chamber of the cranium and runs medial to the levator pectoralis and inserts to the anterodorsal process of the cleithrum. This muscle is not connected with the Baudelot's ligament directly (Fig. 48).

SCORPAENIFORM FISHES: The extrinsic muscle is present in the most of the scorpaeniform fishes, while the intrinsic muscle is present in only some species of the scorpaeniform fishes.

Extrinsic muscle: This muscle is regarded as a pair of the muscles which originates from the occipital region of the cranium, and runs under the obliquus superioris to insert to the swimbladder or the paraphophyses of the abdominal vertebrae. Among the scorpaeniform fishes examined, six types and three subtypes

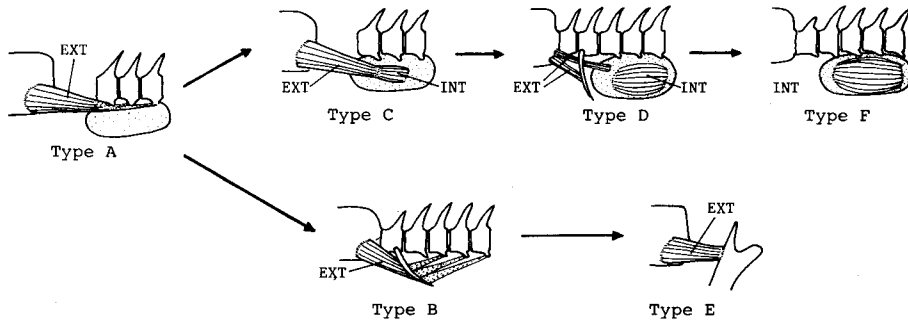

Fig. 51. Hypothetical evolutionary trends of the extrinsic muscle in the scorpaeniform fishes. EXT, extrinsic muscle; INT, intrinsic muscle. For explanation, see text.

of this muscle are observed. Type A is characterized by having the extrinsic muscle which originates from the posteroventral surface of the cranium and inserts to the parapophyses of some abdominal vertebrae tendinously. This type is subdivided into three subtypes on the basis of the condition of this muscle. Subtype A-1 includes the scorpaenid genera *Sebastes*, *Helicolenus* and *Hypodytes*, the synanceiid, the platycephalid and the bembrid fishes. In these fishes, the extrinsic muscle is separated into two layers anteriorly. The ventral layer of this muscle is fused with the Baudelot's ligament, while the medial layer is free from the ligament. Subtype A-2 includes the scorpaenid genera *Sebastlobus* and *Setarches*. In these fishes, the extrinsic muscle is a single muscular mass which is connected with the Baudelot's ligament. Subtype A-3 includes hexagrammid fishes. In these fishes, the extrinsic muscle is a single muscular mass and is not connected with the Baudelot's ligament. Type B includes the zaniolepidid and anoplopomatid fishes. In these fishes, the extrinsic muscle is firmly connected with the obliquus superioris. This muscle originates from the posteroventral surface of the cranium and inserts to the parapophyses of a few abdominal vertebrae. The posterior half of this muscle is graded into the tendinous tissue. This muscle is connected with the anterodorsal process of the cleithrum but it is not connected with the Baudelot's ligament. Type C includes the scorpaenid genus *Pterois* which has the intrinsic muscle. *Pterois* has a cylindrical extrinsic muscle which originates from the occipital region of the cranium and inserts to the swimbladder where this muscle is fused with the intrinsic muscle. In this type, the extrinsic muscle is free from the Baudelot's ligament. Type D is represented by a scorpaenid genus *Apistus* in which the extrinsic is separated into two slender muscular masses. One of them originates from the exoccipital near the vagus foramen and runs along a branch of the vagus nerves to insert the swimbladder. The another muscular mass originates from the basioccipital and inserts to the proximal region of the second epipleral rib. The Baudelot's ligament is free from these muscular masses. Type E is represented by the cyclopterid and liparidid fishes in which the extrinsic muscle originates from the posteroventral surface of the cranium and inserts to the anterodorsal margin of the cleithrum. Type F is represented by the triglid fishes. In these fishes, the extrinsic muscle is not observed.

Intrinsic muscle: This muscle is present on the lateral surface of the swimbladder. In the scorpaeniform fishes, this muscle is observed in the scorpaenid genera *Pterois* and *Apistus*, and the triglid fishes. In *Pterois*, this muscle is fused with the extrinsic muscle anteriorly. In *Apistus* this muscle is not connected with the extrinsic muscle.

Discussion. Among the scorpaeniform fishes, the muscles of the swimbladder have been studied mainly in the scorpaenid and the triglid fishes by Matsubara (1943), Fish (1954), Barber and Mowbrag (1956), Evans (1973), Hallacher (1974) and Litvinenko (1980). Matsubara (1943) studied the extrinsic muscle of the scorpaenoid fishes, and classified the Japanese scorpaenoid fishes into three groups on the basis of the condition of the muscle, and used this character for the phylogenetic consideration of this group. Hallacher (1974) studied the extrinsic muscle of the scorpaenid genus *Sesbates* and the other scorpaeniform fishes, and classified these fishes into four types and discussed the evolutionary implication of the extrinsic muscle in the scorpaeniform fishes.

In the present study, it is clarified that the extrinsic muscle of the cottoid fishes is characterized by having the insertion to the cleithrum. In the generalized percoid fishes, the extrinsic muscle is originated from the posteroventral surface of the cranium and inserted to the parapophyses of the abdominal vertebrae. The generalized percoid type of this muscle can be regarded as the ancestral condition of the cottoid types, but there is a large gap between the both types. Thus, the evolution of this character is discussed among the scorpaeniform fishes. Among the scorpaeniform fishes examined here, the condition of the muscles serving to the swimbladder is classified into six types including three subtypes summerized in the

Table 11. Comparison of the muscles serving to swimbladder in the scorpaeniform fishes.

Morphotype	Extrinsic muscle		Intrinsic muscle	Family and genus
	insertion	condition		
Type A-1	parapophyses	two layers, one of them connecting to Baudelot's ligament	absent	Scorpaenidae; <i>Sebastes</i> , <i>Hypodytes Helicolenus</i> Synanceiidae, Platycephalidae
Type A-2		one layer, connecting to Baudelot's ligament		Scorpaenidae; <i>Sebastolobus</i> , <i>Setarches</i>
Type A-3				Hexagrammidae
Type B	1st epipleural, cleithrum	one layer, free from Baudelot's ligament	present	Zaniolepididae, Anoplopomatidae
Type C	swimbladder			Scorpaenidae; <i>Pterois</i>
Type D	swimbladder, 1st epipleural	two slender muscles, free from Baudelot's ligament		Scorpaenidae; <i>Apistus</i>
Type E	absent			Triglidae, Peristediidae
Type F	cleithrum	one layer, free from Baudelot's ligament	absent	Cottoidea, Cyclopteridae, Liparidae

Fig. 51 and Table 11. Among these types, type A and its subtypes are characterized by having the extrinsic muscle which originates from the posteroventral surface of the cranium and inserts to the parapophyses of the abdominal vertebrae. It is considered that this condition is the most primitive among six types, because this type has been observed in the generalized percoid fishes (Hazlett and Winn, 1962; Schneider, 1964; Tavalga, 1977; Vari, 1978). In the generalized percoid fishes, the relation between the extrinsic muscle and the Baudelot's ligament has not been clarified. It can not be discussed which is the most primitive condition among three subtypes of the type A, though it is considered that they are primitive than any other types. It is estimated that the extrinsic muscle may be evolved from the primitive condition of type A to two directions (Fig. 51). One of them is the direction deriving to condition of the cottoid fishes (type E), and another is the direction deriving to the triglid condition (type F). These two types have not been reported from other fish groups. It is considered that the evolutionary trend to the cottoid type (type A→type B→type E) may be occurred by reduction of the swimbladder and adaptation for the benthic life pattern, while the evolutionary trend to the triglid type (type A→type C→type D→type F) may be occurred by the specialization of the function of the swimbladder such as sound production which has been discussed by many authors (Fish, 1954; Evans, 1973; Tavalga, 1977). Judging from these assumption, it can be considered that the cottoid fishes possess one of the most derived condition, and share this derived condition with the cyclopterid and liparidid fishes. Hallacher (1974) wrote that "Homologies between the cranioclavicle muscle of the cottoids and the elongate muscles of the other scorpaeniform fishes are not clear". But it is considered that the morphological gap between type A and type E can be bridged by the intermediate condition type B of zaniolepidid fishes.

9. MUSCLES BETWEEN THE PECTORAL GIRDLE AND THE CRANIUM, THE HYOID AND THE BRANCHIAL ARCHES

Description

COTTOID FISHES: There are two muscles (the protractor pectoralis, the levator pectoralis) between the pectoral girdle and the cranium, two muscles (the pharyngoclavicularis externus and internus) between the pectoral girdle and the branchial arch, and a muscle (the sternohyoideus) between the pectoral girdle and the hyoid arch. The pharyngoclavicularis externus and internus are described and discussed in the section of the branchial muscles.

Sternohyoideus: This muscle originates from the lateral surface of the urohyal. This muscle consists of three myomeres separated by two myocommata. The posteriormost myomere of this muscle is divided into three inserting heads. The uppermost inserts to the anteroventral fossa of the cleithrum. The middle part of this myomere is continuous with the hypaxialis posteriorly. The lowest part inserts to the ventral tip of the cleithrum.

Protractor pectoralis: This muscle originates from the posterolateral tip of the pterotic, and passes downward to insert to anterodorsal margin of the cleithrum. Anteroventrally this muscle grades into the tissue of the wall of the branchial chamber.

Table 12. Comparison of eight characters of muscular patterns in cottoid fishes. TA-1, number of the anterior tendon of the adductor mandibulae section A1-2; CA-2, connection between the adductor mandibulae section A2 and the ligamentum primordium; HHA, hyohyoideus inferioris; TD, tendon of the transversus dorsalis; NRV, number of the recti ventrales; RVU, rectus ventralis interconnecting the urohyal and the third hypobranchial; COR, coracoradialis; IOS, inserting position of the obliquus superioris. P, primitive condition; D, derived condition.

Morphotype	Character								Family and genus
	TA-1	CA-2	HHA	TD	NRV	RVU	COR	IOS	
I	one(P)	absent (P)	absent (D)	one head (P)	one(P)	absent (P)	absent (D)	cleithrum (D)	Rhamphocottidae; <i>Rhamphocottus</i> Ereuniidae; <i>Marukawichthys</i> , <i>Ereunias</i>
II						cranium (P)		Cottidae; <i>Jordania</i>	
III						present (P)	present (P)	two head (D)	present (P)
IV		Psychrolutidae; <i>Eurymen</i>							
V		Psychrolutidae; <i>Psychrolutes</i>							
VI		Psychrolutidae; <i>Ebinania</i> , <i>Neophrynichthys</i>							
VII		absent (P)	absent (D)	one head (P)		two(D)	absent (D)	absent (D)	Hemitripterae; <i>Hemitripterus bolini</i>
VIII									Hemitripterae; <i>Hemitripterus villosus</i>
IX		present (D)	absent (D)	one head (P)		two(D)	absent (D)	absent (D)	Hemitripterae; <i>Blepsias</i> , <i>Nautichthys</i> Cottidae; <i>Scorpaenichthys</i> , <i>Hemilepidotus</i> , <i>Leptocottus</i> , <i>Chitonotus</i> , <i>Icelus</i> , <i>Stlengis</i> , <i>Icelinus</i> , <i>Thyriscus</i> , <i>Radulinus</i> , <i>Asemichthys</i> , <i>Artedius</i> , <i>Oligocottus</i> , <i>Clinocottus</i> , <i>Artediellus</i> , <i>Zesticelus</i> , <i>Taurocottus</i> , <i>Myoxocephalus</i> , <i>Microcottus</i> , <i>Porocottus</i> , <i>Argyrocottus</i> , <i>Enophrys</i> , <i>Taurulus</i> , <i>Alcichthys</i> , <i>Bero</i> , <i>Ocynectes</i> , <i>Furcina</i> , <i>Pseudoblennius</i> , <i>Vellitor</i> ,
									Cottidae; <i>Cottus</i> , <i>Trachidermus</i> , <i>Ascelichthys</i> , <i>Triglops</i>
									X
XI	absent (P)	absent (D)	one head (P)	two(D)	absent (D)	absent (D)	Agonidae; <i>Agonomalus</i>		
VII							Agonidae; <i>Podothecus</i> , <i>Tylesina</i>		

Levator pectoralis: This muscle originates from the posteroventral region of the skull, and it inserts to the anterodorsal process of the cleithrum. Some fibers of this muscle insert to the posttemporal and the supracleithrum. This muscle is indistinctly divided into two masses. Interspace between these masses are filled with thin muscular tissue.

SCORPAENIFORM FISHES: The conditions of these muscles are almost the same as those of the cottoid fishes. In some scorpaeniform fishes, the distributional pattern of the sternohyoideus differs from that in the cottoid fishes. In the cyclopterid genera *Eumicrotremus*, and *Aptocyclus*, the sternohyoideus is separated into two sections. The upper section originates from the dorsolateral surface of the urohyal and inserts to the middle part of the cleithrum. The lower section originates from the ventrolateral surface of the urohyal and runs posteriorly to insert to the anteroventral surface of the cleithral foot. It does not extend to the hypaxialis.

Remarks: The condition of the muscles of this region is scarcely changed in the cottoid and other scorpaeniform fishes. This condition has also been reported in the generalized percoid fishes (Osse, 1969; Liem, 1970; Winterbottom, 1974a; Elshould-Oldenhave and Osse, 1976). It is considered that the condition of the sternohyoideus observed in the cyclopterid fishes is unique and derived condition among the scorpaeniform fishes.

VII. Phylogenetic classification of the superfamily Cottoidea

1. CHARACTERS AND CONDITIONS

As the result of the comparative anatomy of the cottoid fishes and other scorpaeniform fishes, the effective differences are recognized in 60 characters. The phylogenetic relationships among the cottoid fishes are inferred on the basis of these characters. The condition and the polarity estimated on each character in the present study are summarized below. The asterisk indicates the character whose derived conditions are found in all cottoid fishes. If there are two or more derived conditions, the condition "I" is less derived than the "II", and follows in order. If there are two or more evolutionary trends in a characters, each series indicates as "a", "b" and so on.

1. **Infraorbital:** Primitive condition; five infraorbitals. Derived condition; I) four bones, II) three bones.

2. **Infraorbital sensory canal:** Primitive condition; the canal is not connected with the operculomandibular sensory canal. Derived condition; The former is connected with the latter.

3*. **Suborbital stay:** Primitive condition; the second infraorbital is not elongated posteriorly. Derived condition; it is elongated posteriorly to form the suborbital stay.

4*. **Lachryopalatine articulation:** Primitive condition; the lachrymal is ligamentously connected with the palatine. Derived condition; the lachrymal has an articular head medially which is received in the lateral groove of the palatine to form the lachryopalatine articulation.

5. **Teeth on prevomer:** Primitive condition; teeth are present on the prevomer. Derived condition; no tooth on prevomer.

Table 13. Distribution of the condition of 13 muscular characters among the extensor proprius; AD, adductor dorsalis; EXT, extrinsic muscle; for condition; N, derived condition which is not observed in the cottoid fishes.

Group	Character				
	TA-1	CA-2	HHa	TD	NRV
Cottoidea	P, D	P, D	P, D	P, D	P, D
Cyclopteridae	N	D	N	P	N
Liparididae	N	D	N	P	N
Hexagrammidae	P	D	D	P	P
Zaniolepididae	P	P	D	P	P
Anoplopomatidae	P	P	N	P	P
Scorpaenidae	P, D	P	P	P	P
Synanceiidae	D	P	P	P	P
Platycephalidae	P	P	N	P	P
Trigligae	P	P	N	P	P

6. Palatocranial articulation: Primitive condition; the articular head of the prefrontal is joined to a small facet of the palatine to form a distinct palatocranial articulation. Derived condition; the palatocranial articulation is obscure.

7. Pterosphenoid-parasphenoid junction: Primitive condition; the pterosphenoid is separated from the parasphenoid by interposition of the prootic. Derived condition; the lateral wing of the parasphenoid extends upward and attaches to the pterosphenoid.

8. Trigemino-facialis chamber: Primitive condition; a broad vertical bridge crosses over the trigemino-facialis chamber. Derived condition; I) a narrow vertical bridge crosses over the chamber, II) the vertical bridge is absent.

9. Basioccipital-parasphenoid fossa: Primitive condition; this fossa is absent. Derived condition; a pair of deep fossa is present on the ventral surface of occipital region to form the basioccipital-parasphenoid fossa.

10. Baudelot's ligament: Primitive condition; the Baudelot's ligament inserts to the posterior tip of the basioccipital. Derived condition; this ligament inserts to the first vertebra.

11. Supratemporal commissure: Primitive condition; the supratemporal is a single bone having three openings. The tubular structures on the parietal and pterotic are not free from the basal bones. Derived condition; I) the supratemporal is composed of two tubular bones, and the tubular structures on the parietal and the pterotic are not free from the basal bones. II) the supratemporal is composed of two elements. The posterior tubular structure on the pterotic is free from the basal bone. III) the posterior supratemporal is lost. The posterior tubular structure on the pterotic is free from the basal bone. IV) the posterior supratemporal is lost. The posterior tubular structure of the pterotic and the tubular structure of the parietal are free from the basal bones. V) all tubular structures on the parietal and pterotic are free from the basal bones.

12*. Basisphenoid: Primitive condition; this bone is present. Derived

scorpaeniform fishes. LE, levotor externus; PHI, pharyngoelavicularis internus; EXP, other abbreviations of characters, see Table 12. P, primitive condition; D, derived

RVU	COR	IOS	LE	PHI	EXP	AD	EXT
P, D	P, D	P, D	D	P	D	D	D
P	D	D	D	D	N	D	D
P	D	D	D	D	N	D	D
P	P	P	P	P	D	D	P
P	P	P	P	P	P	D	P
P	P	P	P	P	P	D	P
P	P	P	P	P	P	P	P, N
P	P	P	D	P	P	D	P
P	P	P	P	P	P	P	P
P	P	P	P	P	P	P	N

condition; this bone is absent.

13*. Intercalar: Primitive condition; the intercalar is large and extends to the prootic. Derived condition; the intercalar is small and does not extend to the prootic.

14*. Posttemporal fossa: Primitive condition; this fossa is deep and inserted by the lateral head of the epaxialis. Derived condition; the posttemporal fossa is shallow and not inserted by numerous muscular fibers.

15. Entopterygoid: Primitive condition; this bone attaches or closely lies to the metapterygoid posteriorly. Derived condition; I) this bone is far separated from the metapterygoid, II) this bone is lost.

16. Palatine teeth: Primitive condition; the palatine teeth are present. Derived condition; the palatine teeth are absent.

17. Lateral process of the hyomandibular: Primitive condition; this process is obscure or absent. Derived condition; this process is well developed on the posterodorsal margin of the hyomandibular.

18*. Metapterygoid lamina: Primitive condition; the metapterygoid lamina is present on the lateral surface of the metapterygoid. Derived condition; the metapterygoid lamina is absent.

19. First pharyngobranchial (suspensory pharyngeal): Primitive condition; this is present as a rod-like bone. Derived condition; this bone is absent.

20*. Pharyngobranchials and tooth plates: Primitive condition; the second to fourth pharyngobranchials bearing tooth plates are present. Derived condition; I) the second and third bones and their tooth plates are present, II) the second and third bones and a tooth plate on the latter are present, III) the third bone and its tooth plate are present.

21. Third epibranchial: Primitive condition; a tooth plate is present on the third epibranchial. Derived condition; a tooth plate is absent on the third epibranchial.

22*. Basihyal: Primitive condition; the basihyal is present as a rod-like bone situated on the anterior tip of hyoid arch. Derived condition; I) the basihyal is present as a small unossificated bone situated on the anterior tip of the hyoid arch, II) the basihyal is present as a tiny bone sandwiched between the hypohyals on both side, III) this bone is absent.

23. Branchiostegal rays: Primitive condition; seven rays are present. Derived condition; six rays are present.

24*. Scapula foramen: Primitive condition; the scapula foramen is completely closed. Derived condition; I) the foramen is closed, but a crack is present on the anterior part of this bone, II) the foramen is present between the scapula and the cleithrum.

25*. Scapula-coracoid connection: Primitive condition; the scapula is attached to the coracoid. Derived condition; they are separated.

26. Actinost: Primitive condition; four actinosts are present. Derived condition; three bones are present (the uppermost one is fused with the scapula).

27. Pores between each actinost: Primitive condition; one to four small pores are present between actinosts. Derived condition; the pore is absent.

28. Free pectoral fin rays: Primitive condition; all pectoral fin rays are interconnected by the fin membranes. Derived condition; lower four rays are separated from the upper lobe to form the free rays.

29. Continuous pectoral fin: Primitive condition; the pectoral fins of both sides do not continue. Derived condition; the pectoral fins on both sides continue each other on the ventral midline.

30. Pelvis: Primitive condition; the subpelvic keel and suprapelvic keel are normal. Derived condition; both keels are well developed and project forwards.

31. Pelvic fin rays: Primitive condition; pelvic fin is composed of one spine and five soft rays. Derived condition; I) one spine and four soft rays, II) one spine and three soft rays, III) one spine and two soft rays, IV) one rudimentary spine or absent.

32. Anterior proximal pterygiophore of the dorsal series: Primitive condition; the first proximal pterygiophore inserts to the second interspace. Derived condition; Ia) the first inserts to the first interspace, IIa) anterior two pterygiophores insert to the first interspace. Ib) the first one inserts to the fifth interspace, IIb) the first inserts to the seventh interspace.

33. Stay: Primitive condition; this bone is present behind last pterygiophore. Derived condition; the stay is absent.

34. Fin rays on the last proximal pterygiophore: Primitive condition; two fin rays are present on the last proximal pterygiophores of dorsal and anal series. Derived condition; I) the last proximal pterygiophore of dorsal series supports one ray, and the last one of anal series supports two rays. II) the last ones of the dorsal and anal series support a fin ray.

35*. Anal fin: Primitive condition; spiny rays are present. Derived condition; spiny ray is absent.

36*. Pleural ribs: Primitive condition; the pleural rib begins at the third vertebra. Derived condition; the pleural rib begins at the sixth vertebra or more posterior.

37*. Epipleural ribs: Primitive condition; epipleural ribs attach to pleural ribs. Derived condition; epipleural ribs do not attach to the pleural ribs.

38*. Haemal spines on the preural centra: Primitive condition; haemal spine of the preural centrum II is suturally attached to the centrum. Derived condition; the haemal spine of the preural centrum II is fused with the centrum.

39*. Hypurapophysis: Primitive condition; the hypurapophysis is developed on the parhypural. Derived condition; the hypurapophysis is absent.

40*. Preural centrum I: Primitive condition; preural centrum I is not fused with the hypurals. Derived condition; preural centrum I is fused with the hypural-parhypural complex.

41*. Hypural-parhypural complex bone: Primitive condition; the complex bone is composed of three or more elements. Derived condition; I) the complex is composed of the upper and lower elements, II) the complex is composed of a single element.

42. Caudal fin: Primitive condition; branched rays are present. Derived condition; branched rays are absent.

43. Neural spine of the preural centrum II: Primitive condition; the neural spine of the preural centrum II is not elongated. Derived condition; the neural spine is elongated and supports the procurrent rays.

44. Isthmus: Primitive condition; branchiostegal membranes are joined and free from the isthmus. Derived condition; I) branchiostegal membranes are fused to the isthmus and form a narrow free fold, II) branchiostegal membranes are fused to isthmus without any free fold.

45. Body scales: Primitive condition; ctenoid scales are present on the body. Derived condition; Ia) body is naked, Ib) covered with minute spiny scales, Ic) covered with minute multifid spines, Id) covered with large bony plates.

46. Position of anus: Primitive condition; anus is situated immediately anterior to anal fin. Derived condition; I) anus is situated about midway between the pelvic and anal fin origins, II) anus is situated immediately posterior to the pelvic fin.

47. Adductor mandibulae: Primitive condition; the section A1 of this muscle is not subdivided. Derived condition; the section A1 is subdivided into two parts (this condition is observed in the cyclopterid and the liparidid fishes).

48*. Hyohyoidei abductores section 2: Primitive condition; this muscle crosses over its antimere. Derived condition; this muscle is fused to its antimere.

49. Hyohyoidei inferiores: Primitive condition in the cottoid fishes; this muscle is present. Derived condition in the cottoid fishes; this muscle is absent. For condition among the other scorpaeniform fishes, see and Table 10.

50. Transversus dorsalis: Primitive condition; this muscle inserts to the second epibranchial. Derived condition; this muscle inserts to the second and third epibranchials.

51*. Levator externus III: Primitive condition; this muscle is present. Derived condition; this muscle is absent.

52. Rectus ventralis: Primitive condition; the rectus ventralis III is present, but other elements are absent. Derived condition; the recti ventrales II and III are present.

Table 14. The summary of the character conditions of 61 genera or species of the superfamily D3.....; Da, Db, Dc and Dd, derived condition of different trend); —, primitive condition.

Character	1	2	3	4	5	6	7	8	9	10	11	12	13	14	15	16
1. <i>Jordania</i>	—	—	D	D	—	—	D	D1	—	—	D1	D	D	D	—	—
2. <i>Scorpaenichthys</i>	—	—	D	D	—	—	D	D1	—	—	D1	D	D	D	—	—
3. <i>Hemilepidotus</i>	—	—	D	D	—	—	D	D1	—	—	D1	D	D	D	—	—
4. <i>Leptocottus</i>	—	—	D	D	—	—	D	D1	—	—	D1	D	D	D	—	—
5. <i>Trachidermus</i>	—	—	D	D	—	—	D	D1	—	—	D1	D	D	D	D2	—
6. <i>Cottus kazika</i>	—	—	D	D	—	—	D	D1	—	—	D1	D	D	D	—	—
7. <i>Cottus pollux</i>	—	—	D	D	—	—	D	D1	—	—	D1	D	D	D	—	D
8. <i>Artedius</i>	—	—	D	D	—	—	D	D1	—	—	D1	D	D	D	—	—
9. <i>Chitonotus</i>	—	—	D	D	—	—	D	D1	—	—	D1	D	D	D	—	—
10. <i>Orthonopias</i>	—	—	D	D	—	—	D	D1	—	—	D1	D	D	D	—	—
11. <i>Triglops</i>	D1	—	D	D	—	—	D	D1	—	—	D1	D	D	D	—	D
12. <i>Radulinus</i>	D1	—	D	D	—	—	D	D1	—	—	D1	D	D	D	D2	D
13. <i>Asemichthys</i>	D1	—	D	D	—	—	D	D1	—	—	D1	D	D	D	D2	D
14. <i>Astrocottus</i>	D1	—	D	D	—	—	D	D1	—	—	D1	D	D	D	D2	D
15. <i>Icelus</i>	—	—	D	D	—	—	D	D1	—	—	D1	D	D	D	—	—
16. <i>Ricuzenius</i>	—	—	D	D	—	—	D	D1	—	—	D1	D	D	D	—	—
17. <i>Stelgistrum</i>	—	—	D	D	—	—	D	D1	—	—	D1	D	D	D	—	D
18. <i>Thyriscus</i>	D1	—	D	D	—	—	D	D1	—	—	D1	D	D	D	—	—
19. <i>Silengis</i>	—	—	D	D	—	—	D	D1	—	—	D1	D	D	D	D1	—
20. <i>Icelinus</i>	—	—	D	D	—	—	D	D1	—	—	D1	D	D	D	D1	—
21. <i>Oligocottus</i>	—	—	D	D	—	—	D	D1	—	—	D1	D	D	D	—	—
22. <i>Clinocottus</i>	—	—	D	D	—	—	D	D1	—	—	D1	D	D	D	—	—
23. <i>Leiocottus</i>	—	—	D	D	—	—	D	D1	—	—	D1	D	D	D	—	D
24. <i>Synchirus</i>	—	—	D	D	—	—	D	D1	—	—	D1	D	D	D	D2	D
25. <i>Gymnocanthus</i>	—	—	D	D	D	D	D	D1	—	—	D1	D	D	D	—	D
26. <i>Ascelichthys</i>	D1	—	D	D	—	—	D	D1	—	—	D1	D	D	D	—	—
27. <i>Taurocottus</i>	D1	—	D	D	—	—	D	D1	—	—	D1	D	D	D	—	—
28. <i>Trichocottus</i>	D1	—	D	D	—	—	D	D1	—	—	D1	D	D	D	—	D
29. <i>Myoxocephalus</i>	D1	—	D	D	—	—	D	D1	—	—	D1	D	D	D	—	D
30. <i>Microcottus</i>	D1	—	D	D	—	—	D	D1	—	—	D1	D	D	D	—	D
31. <i>Porocottus</i>	D1	—	D	D	—	—	D	D1	—	—	D1	D	D	D	—	D
32. <i>Argyrocottus</i>	D1	—	D	D	—	—	D	D1	—	—	D1	D	D	D	—	D
33. <i>Enophrys</i>	D1	—	D	D	—	—	D	D1	—	—	D1	D	D	D	—	D
34. <i>Taurulus</i>	D1	—	D	D	—	—	D	D1	—	—	D1	D	D	D	—	D
35. <i>Artediellus</i>	D1	—	D	D	—	—	D	D1	—	—	D1	D	D	D	D1	—
36. <i>Artediellichthys</i>	D1	—	D	D	—	—	D	D1	—	—	D1	D	D	D	D1	—
37. <i>Cottiusculus</i>	D1	—	D	D	—	—	D	D1	—	—	D1	D	D	D	D1	—
38. <i>Zesticelus</i>	D1	—	D	D	—	—	D	D1	—	—	D1	D	D	D	D1	D
39. <i>Alicichthys</i>	—	—	D	D	—	—	D	D1	—	—	D1	D	D	D	—	—
40. <i>Bero</i>	—	—	D	D	—	—	D	D1	—	—	D1	D	D	D	—	—
41. <i>Ocynectes</i>	—	—	D	D	—	—	D	D1	—	—	D1	D	D	D	—	—
42. <i>Furcina</i>	—	—	D	D	—	—	D	D1	—	—	D1	D	D	D	D1	—
43. <i>Pseudoblennius</i>	—	—	D	D	—	—	D	D1	—	D	D1	D	D	D	D1	—
44. <i>Vellitor</i>	—	—	D	D	—	—	D	D1	—	D	D1	D	D	D	D1	—
45. <i>Hemistriperus v.</i>	—	—	D	D	—	—	—	D2	—	D	D1	D	D	D	—	—
46. <i>Hemistriperus b.</i>	—	—	D	D	—	—	—	D2	—	D	—	D	D	D	—	—
47. <i>Blepsias</i>	D1	—	D	D	—	—	—	D2	—	D	D1	D	D	D	—	—
48. <i>Nautichthys</i>	D1	—	D	D	—	—	D	D1	—	D	D1	D	D	D	—	—
49. <i>Agonomalus</i>	D2	—	D	D	D	D	D	D2	—	D	—	D	D	D	—	—
50. <i>Podotheucus</i>	D2	—	D	D	D	D	D	D1	—	D	—	D	D	D	—	D
51. <i>Tilesina</i>	D2	—	D	D	—	—	D	D1	—	D	—	D	D	D	D1	—
52. <i>Marukawichthys</i>	—	—	D	D	—	—	D	D1	—	—	D1	D	D	D	—	—
53. <i>Ereunias</i>	—	—	D	D	—	—	D	D1	—	—	D1	D	D	D	—	—
54. <i>Dasycottus</i>	D1	D	D	D	—	—	D	D2	—	—	D2	D	D	D	—	D
55. <i>Eurymen</i>	D1	D	D	D	—	—	D	D2	—	—	D2	D	D	D	—	D
56. <i>Cottunculus</i>	D2	D	D	D	—	—	D	D2	—	—	D3	D	D	D	—	D
57. <i>Ebinania</i>	D1	D	D	D	—	—	D	D2	—	—	D4	D	D	D	—	D
58. <i>Neophrynichthys</i>	D1	D	D	D	D	D	—	D2	—	—	D4	D	D	D	—	D
59. <i>Malacocottus</i>	D1	D	D	D	D	D	—	D2	—	—	D4	D	D	D	—	D
60. <i>Psychrolutes</i>	D1	D	D	D	D	D	—	D2	—	—	D5	D	D	D	—	D
61. <i>Rhamphocottus</i>	D1	—	D	D	—	—	D	D	—	—	—	D	D	D	—	D

Cottoidea. For character's number, see text. D, derived condition (D1 < D2 <

17	18	19	20	21	22	23	24	25	26	27	28	29	30	31	32	33	34	35	36	37
D	D	—	D1	D	D2	D	D1	D	—	—	—	—	—	—	—	D	—	D	D	D
D	D	D	D1	D	D3	D	D2	D	D	—	—	—	—	—	D1a	D	—	D	D	D
D	D	D	D1	D	D3	D	D2	D	—	—	—	—	—	D1	—	D	—	D	D	D
D	D	D	D1	D	D3	D	D2	D	—	—	—	—	—	D1	—	D	D2	D	D	D
D	D	D	D1	D	D3	D	D2	D	—	—	—	—	—	D1	—	D	D2	D	D	D
D	D	D	D1	D	D3	D	D2	D	—	—	—	—	—	D1	—	D	D2	D	D	D
D	D	D	D1	D	D3	D	D2	D	—	—	—	—	—	D2	—	D	D2	D	D	D
D	D	D	D1	D	D3	D	D2	D	—	—	—	—	—	D2	D1a	D	D2	D	D	D
D	D	D	D1	D	D3	D	D2	D	—	—	—	—	—	D2	—	D	D2	D	D	D
D	D	D	D1	D	D3	D	D2	D	—	—	—	—	—	D2	—	D	D2	D	D	D
D	D	D	D1	D	D3	D	D2	D	—	—	—	—	—	D2	—	D	D2	D	D	D
D	D	D	D3	D	D3	D	D2	D	—	—	—	—	—	D2	—	D	D2	D	D	D
D	D	D	D3	D	D3	D	D2	D	—	—	—	—	—	D2	—	D	D2	D	D	D
D	D	D	D3	D	D3	D	D2	D	—	—	—	—	—	D2	—	D	D2	D	D	D
D	D	D	D3	D	D3	D	D2	D	—	—	—	—	—	D2	—	D	D2	D	D	D
D	D	D	D3	D	D3	D	D2	D	—	—	—	—	—	D3	—	D	D2	D	D	D
D	D	D	D3	D	D3	D	D2	D	—	—	—	—	—	D3	D1a	D	D2	D	D	D
D	D	D	D1	D	D3	D	D2	D	—	—	—	—	—	D2	—	D	D2	D	D	D
D	D	D	D1	D	D3	D	D2	D	—	—	—	—	—	D2	—	D	D2	D	D	D
D	D	D	D1	D	D3	D	D2	D	—	—	—	—	—	D2	—	D	D2	D	D	D
D	D	D	D3	D	D3	D	D2	D	—	—	—	—	—	D2	—	D	D2	D	D	D
D	D	D	D3	D	D3	D	D2	D	—	—	—	—	—	D2	—	D	D2	D	D	D
D	D	D	D3	D	D3	D	D2	D	—	—	—	—	—	D2	—	D	D2	D	D	D
D	D	D	D3	D	D3	D	D2	D	—	—	—	—	—	D2	—	D	D2	D	D	D
D	D	D	D3	D	D3	D	D2	D	—	—	—	—	—	D2	—	D	D2	D	D	D
D	D	D	D1	D	D3	D	D2	D	—	—	—	—	—	D2	—	D	D2	D	D	D
D	D	D	D1	D	D3	D	D2	D	—	—	—	—	—	D3	—	D	D2	D	D	D
D	D	D	D1	D	D3	D	D2	D	—	—	—	—	—	D3	D1a	D	D2	D	D	D
D	D	D	D2	D	D3	D	D2	D	—	—	—	—	—	D3	D1a	D	D2	D	D	D
D	D	D	D3	D	D3	D	D2	D	—	—	—	—	—	D3	D1a	D	D2	D	D	D
D	D	D	D3	D	D3	D	D2	D	—	—	—	—	—	D3	D1a	D	D2	D	D	D
D	D	D	D3	D	D3	D	D2	D	—	—	—	—	—	D3	D1a	D	D2	D	D	D
D	D	D	D3	D	D3	D	D2	D	—	—	—	—	—	D3	D1a	D	D2	D	D	D
—	D	D	D3	—	D3	—	D2	D	—	—	—	—	—	D2	D2a	D	D1	D	D	D
—	D	D	D3	D	D3	D	D2	D	—	—	—	—	—	D2	—	D	D1	D	D	D
—	D	D	D2	D	D3	D	D2	D	—	—	—	—	—	D2	—	D	D2	D	D	D
—	D	D	D3	D	D3	D	D2	D	—	—	—	—	—	D2	—	D	D1	D	D	D
—	D	D	D3	D	D3	D	D2	D	—	—	—	—	—	D3	—	D	D2	D	D	D
—	D	D	D3	D	D3	D	D2	D	—	—	—	—	—	D3	D1b	D	D2	D	D	D
—	D	D	D3	D	D3	D	D2	D	—	—	—	—	—	D3	D2b	D	D2	D	D	D
—	D	—	D1	D	D3	D	D2	D	—	—	D	—	—	D1	D1a	—	D2	D	D	D
—	D	—	D1	D	D3	D	D2	D	—	—	D	—	—	D4	D1a	—	D2	D	D	D
—	D	D	D3	D	D3	—	D2	D	—	D	—	—	—	D2	—	D	D2	D	D	D
—	D	D	D3	D	D3	—	D2	D	—	D	—	—	—	D2	—	D	D2	D	D	D
—	D	D	D3	D	D3	—	D2	D	—	D	—	—	—	D2	—	D	D2	D	D	D
—	D	D	D3	D	D3	—	D2	D	—	D	—	—	—	D2	—	D	D2	D	D	D
—	D	D	D3	D	D3	—	D2	D	—	D	—	—	—	D2	—	D	D2	D	D	D
—	D	D	D3	D	D3	—	D2	D	—	D	—	—	—	D2	—	D	D2	D	D	D
—	D	—	D1	D	D1	D	D1	D	—	—	—	—	D	D2	—	—	D1	D	D	D

Table 14. (continued).

38	39	40	41	42	43	44	45	46	47	48	49	50	51	52	53	54	55	56	57	58	59	60
D	D	D	D1	—	—	—	—	—	—	D	D	—	D	—	D	D	—	D	D	—	—	D
D	D	D	D1	—	—	—	D1a	—	—	D	D	—	D	—	D	D	D	D	D	—	—	D
D	D	D	D1	—	—	—	—	—	—	D	D	—	D	—	D	D	D	D	D	—	—	D
D	D	D	D2	—	D	D2	D1a	—	—	D	D	—	D	—	D	D	D	D	D	—	—	D
D	D	D	D2	—	—	D2	D1a	—	—	D	D	—	D	—	D	D	D	D	D	—	D	D
D	D	D	D2	—	D	D2	D1a	—	—	D	D	—	D	—	D	D	D	D	D	—	D	D
D	D	D	D2	—	D	D2	D1a	—	—	D	D	—	D	—	D	D	D	D	D	—	D	D
D	D	D	D2	—	D	—	—	—	—	D	D	—	D	—	D	D	D	D	D	—	—	D
D	D	D	D2	—	D	—	—	—	—	D	D	—	D	—	D	D	D	D	D	—	—	D
D	D	D	D2	—	D	—	—	D2	—	D	D	—	D	—	D	D	D	D	D	—	—	D
D	D	D	D2	—	D	—	—	—	—	D	D	—	D	—	D	D	D	D	D	—	—	D
D	D	D	D2	—	D	—	—	—	—	D	D	—	D	—	D	D	D	D	D	—	—	D
D	D	D	D2	—	D	—	—	—	—	D	D	—	D	—	D	D	D	D	D	—	—	D
D	D	D	D2	—	D	—	—	—	—	D	D	—	D	—	D	D	D	D	D	—	—	D
D	D	D	D2	—	D	—	—	—	—	D	D	—	D	—	D	D	D	D	D	—	—	D
D	D	D	D2	—	D	—	D1a	—	—	D	D	—	D	—	D	D	D	D	D	—	—	D
D	D	D	D2	—	D	—	D1a	D1	—	D	D	—	D	—	D	D	D	D	D	—	—	D
D	D	D	D2	—	D	—	D1a	D2	—	D	D	—	D	—	D	D	D	D	D	—	—	D
D	D	D	D2	—	D	—	D1a	—	—	D	D	—	D	—	D	D	D	D	D	—	—	D
D	D	D	D2	—	D	—	D1a	—	—	D	D	—	D	—	D	D	D	D	D	—	—	D
D	D	D	D2	—	D	—	D1a	—	—	D	D	—	D	—	D	D	D	D	D	—	—	D
D	D	D	D2	—	D	—	D1a	—	—	D	D	—	D	—	D	D	D	D	D	—	—	D
D	D	D	D2	—	D	—	D1a	—	—	D	D	—	D	—	D	D	D	D	D	—	—	D
D	D	D	D2	—	D	—	D1a	—	—	D	D	—	D	—	D	D	D	D	D	—	—	D
D	D	D	D2	—	D	—	D1a	—	—	D	D	—	D	—	D	D	D	D	D	—	—	D
D	D	D	D2	—	D	—	D1a	—	—	D	D	—	D	—	D	D	D	D	D	—	—	D
D	D	D	D2	—	D	—	D1a	—	—	D	D	—	D	—	D	D	D	D	D	—	—	D
D	D	D	D2	—	D	—	D1a	—	—	D	D	—	D	—	D	D	D	D	D	—	—	D
D	D	D	D1	D	D	—	D1b	—	—	D	D	D	D	—	D	D	D	D	D	—	—	D
D	D	D	D1	D	D	—	D1b	—	—	D	D	—	D	—	D	D	D	D	D	—	—	D
D	D	D	D1	—	D	D2	D1b	—	—	D	D	—	D	—	D	D	D	D	D	—	—	D
D	D	D	D2	D	D	—	D1d	D2	—	D	D	—	D	D	D	D	D	D	D	—	—	D
D	D	D	D2	D	D	—	D1d	D2	—	D	D	—	D	D	D	D	D	D	D	—	—	D
D	D	D	D2	—	D	—	—	—	—	D	D	—	D	—	—	D	D	D	D	—	—	D
D	D	D	D2	—	D	—	—	—	—	D	D	—	D	—	—	D	D	D	D	—	—	D
D	D	D	D2	—	D	—	D1a	—	—	D	D	—	D	—	D	D	D	D	D	—	—	D
D	D	D	D2	—	D	D2	D1a	—	—	D	D	—	D	—	D	D	D	D	D	—	—	D
D	D	D	D2	—	D	D2	D1a	—	—	D	—	—	D	—	D	D	D	D	D	—	—	D
D	D	D	D2	—	D	D2	D1a	—	—	D	D	—	D	—	D	D	D	D	D	—	—	D
D	D	D	D2	—	D	D2	D1a	—	—	D	D	—	D	—	D	D	D	D	D	—	—	D
D	D	D	D2	—	D	D2	D1a	—	—	D	—	—	D	—	D	D	D	D	D	—	—	D
D	D	D	D2	D	D	D2	D1c	—	—	D	D	—	D	—	—	D	D	D	D	—	—	D

53. *Rectus ventralis* interconnecting the urohyal and the third hypobranchial: Primitive condition; this muscle is absent. Derived condition; this muscle is present.

54*. *Extensor proprius*: Primitive condition; this muscle is present. Derived condition; this muscle is absent.

55. *Obliquus superioris*: Primitive condition; this muscle extends to the cranium. Derived condition; this muscle inserts to the cleithrum and does not extend to the cranium.

56*. *Adductor dorsalis*: Primitive condition; this muscle is present. Derived condition; this muscle is absent.

57*. *Extrinsic muscle*: Primitive condition; this muscle inserts to the vertebrae. Derived condition; this muscle inserts to the cleithrum.

58. Anterior tendon of the adductor mandibulae section A1: Primitive condition; a tendon extends to medial surface of the maxillary head. Derived condition; two tendons are present, one extends to the maxillary head and another has the common insertion of the ligamentum primordium.

59. Connection between the adductor mandibulae section A2 and the ligamentum primordium: Primitive condition; this connection is absent. Derived condition; some muscular fibers extend to the ligamentum primordium.

60. *Coracoradialis*: Primitive condition; this muscle is present. Derived condition; this muscle is absent.

Distributions of above character conditions among the cottoid fishes are summarized in Table 14.

2. MONOPHYLY OF THE COTTOID FISHES

The cottoid fishes examined here are regarded as the monophyletic group defined by the combination of the following 22 synapomorphies, because the combination of these synapomorphies is unique among the scorpaeniform fishes examined here. It, therefore, is considered that any other scorpaeniform fishes could not be derived from the most recent common ancestor of the cottoid fishes hypothetically defined by these synapomorphies. The 22 synapomorphies with their character numbers in Table 14 are as follows: the suborbital stay is present (No. 3); the lachrymal is possessed of a developed articular head dorsomedially which articulates with the lateral groove of the palatine to form the lachryopalatine articulation (No. 4); the basisphenoid is absent (No. 12); the intercalar is present as a small bone which does not extend to the prootic (No. 13); the posttemporal fossa is not developed (No. 14); the metapterygoid lamina is absent (No. 18); the fourth pharyngobranchial and its tooth plate is absent (No. 20); the basihyal is absent or present as a tiny bone or a cartilage (No. 22); the scapula foramen is not completely closed (No. 24); the scapula is not attached with the coracoid (No. 25); the spiny ray is absent on the anal fin (No. 35); the first pleural rib begins at the sixth centrum or more posterior (No. 36); the pleural and the epipleural ribs are attached to the centrum (No. 37); the haemal spine on the preural centrum II is fused with the centrum (No. 38); the hypurapophysis is absent (No. 39); the hypural-parhypural complex bone is composed of one or two elements, and fused with the preural centrum I (No. 40, 41); the hyohyoidei abductores section 2 is fused with its

* Table 15. Distribution of conditions of 22 characters, in which the cottoid fishes are d, derived and primitive conditions are present in a taxon; —, primitive condition.

Character	3	4	12	13	14	18	20
Cottoidea	D	D	D	D	D	D	D
Cyclopteridae	D	D	D	D	D	D	D
Liparididae	D	D	D	D	D	D	D
Hexagrammidae	D	D	—	—	—	—	—
Zaniolepididae	D	D	—	—	—	—	—
Anoplopomatidae	D	—	—	D	—	—	—
Other scorpaeniform fishes	D	—	d	—	—	d	—

opposite member on the ventral midline (No. 48); the levator externus III is absent (No. 51); the extensor proprius is absent (No. 54); the adductor dorsalis of the caudal muscle is absent (No. 56); the extrinsic muscle interconnects the cranium and the anterodorsal process of the cleithrum (No. 57). The distributional pattern of the synapomorphies of the all cottoid fishes among the other scorpaeniform fishes are shown in Table. 15

From this distributional pattern of the character conditions, it can not be discussed the relationships among the scorpaeniform fishes. But, at least it can be discussed the relationships between the cottoid fishes and the cyclopterid and liparidid fishes. Cottoid fishes are considered to be more closely related to cyclopterid and liparidid fishes than to the other scorpaeniform fishes, because they share 20 of the synapomorphies. Among these characters, five characters (Nos. 14, 20, 22, 36, 57) are regarded as autapomorphies of the cottoid, cyclopterid and liparidid fishes among the scorpaeniform fishes. But cyclopterid and liparidid fishes possess the primitive condition of the haemal spine of the preural cantrum II (No. 38), and liparidid fishes possess the primitive condition of the hypural-parhypural complex (No. 40). It, therefore, is considered that the cyclopterid and liparidid fishes could not be derived from the most recent common ancestor of the cottoid fishes. On the other hand, the cyclopterid and the liparidid fishes share following four synapomorphies which are all unique conditions among the scorpaeniform fishes: 1) the pelvic fin is modified to form a sucking disk, 2) the adductor mandibulae section A1 is divided into two subsections, 3) the pharyngo-clavicularis internus inserts to the suprapelvic process of the pelvis, 4) hyohyoides inferioris is well developed and fused with its antimere on the ventral midline. These conditions suggest that the cyclopterid and liparidid fishes form a monophyletic group. Such a group is probably the sister group for the monophyletic group of all cottoid fishes.

3. RELATIONSHIPS AMONG THE COTTOID FAMILIES

In order to rank the familial level of the cottoid fishes, the branching patters of 61 genera and species examined here are inferred on the basis of 52 characters summarized in Table 14. Results of this analysis, six basal stems which are defined by autapomorphies and unique combinations of synapomorphies are inferred (Fig.

possessed of derived condition, among the scorpaeniform fishes. D, derived condition;

22	24	25	35	36	37	38	39	40	41	48	51	54	56	57
D	D	D	D	D	D	D	D	D	D	D	D	D	D	D
D	D	D	D	D	D	—	D	D	D	D	D	D	D	D
D	D	D	D	D	D	d	D	—	D	D	D	D	D	D
—	—	D	D	—	D	—	D	—	—	D	—	D	D	—
—	—	—	—	—	D	—	—	D	D	D	—	—	D	—
—	—	—	—	—	D	—	—	—	—	—	—	—	D	—
—	d	d	d	—	—	—	—	—	—	d	d	—	d	—

52). In this section, the branching pattern of the basal six stems and ranking of the family level are discussed. In the following discussion, these six stems will be referred to as the rhamphocottid stem, the psychrolutid stem, the ereuniid stem, the agonid stem, the hemitripterid stem and the cottid stem.

The branching pattern of these stems is participated by following 16 characters: the number of infraorbitals (No. 1); the condition of the infraorbital sensory canal (No. 2); the condition of the trigeminofacialis chamber (No. 8); the presence or absence of the basioccipital-parasphenoid fossa (No. 9); the position of the Baudelot's ligament (No. 10); the condition of the supratemporal commissure (No. 11); the presence or absence of the lateral process of the hyomandibular (No. 17); the condition of the basihyal (No. 22); the number of branchiostegal rays (No. 23); the presence or absence of the free rays on the pectoral fin (No. 28); the condition of the pelvis and its muscles (No. 30); the condition of the stay (No. 33); the condition of the body scales (No. 45); the presence or absence of the rectus ventralis II (No. 52); the presence or absence of the rectus ventralis interconnecting between the urohyal and the third hypohyal (No. 53); the presence or absence of the coracoradialis (No. 60).

In this branching pattern, the rhamphocottid stem is branched from the common stem of the other cottoid fishes at the first branching point. This stem is characterized by having three autapomorphies; the presence of the multifid spines on body (No. 45), the unique condition of the pelvis and its muscles (No. 30, see Fig. 46), and the presence of the basioccipital-parasphenoid fossa (No. 9). On the other hand, the common stem of the other stems is characterized by having two synapomorphies which are intermediate derived conditions; the presence of the narrow vertical bridge on the trigeminofacialis chamber or the absence of this bridge (No. 8) and the presence of tiny basihyal or absence of this bone (No. 22). This common stem is trichotomously branched at the second branching point. The psychrolutid stem is characterized by having two autapomorphies; highly specialized supratemporal commissure (No. 11), and the infraorbital sensory canal connected with the operculomandibular sensory canal (No. 2). The ereuniid stem is characterized by having an autapomorphy which is the presence of the free rays on the pectoral fin (No. 12).

The common stem of the agonid, hemitripterid and cottid stems is characterized

by having the combination of four synapomorphies; six branchiostegals (No. 23), absence of the stay (No. 33), presence of the rectus ventralis interconnecting the urohyal and the third hypobranchial (No. 53) and absence of the coracoradialis (No. 60). This common stem is dichotomously branched at the next branching point. One is the common stem of the agonid and the hemitripterid stems, and another is the cottid stem. The former is characterized by having a synapomorphy which is the Baudelot's ligament inserting to the first vertebra (No. 10). This stem is branched into the agonid stem and the hemitripterid stem at the next branching position. The agonid stem is characterized by having three autapomorphies; bony plate covering over the body (No. 45), three infraorbitals (No. 1), and the presence of the rectus ventralis II (No. 52). The hemitripterid stem is characterized by having an autapomorphy which is minute spines covering over the body (No. 45). On the other hand, the cottid stem is characterized by having an autapomorphy which is the presence of the lateral process of the hyomandibular (No. 17).

Judging from this branching pattern, it is considered that these six stems are composed of the monophyletic groups defined by the autapomorphies and the unique combinations of the synapomorphies respectively. Therefore, it seems to be reasonable that these stems are ranked as the family. The rhamphocottid stem is named as the family Rhamphocottidae, the psychrolutid stem is as the family Psychrolutidae, the ereuniid stem is as the family Ereuniidae, the agonid stem is as the family Agonidae, the hemitripterid stem is as the family Hemitripteridae, and the cottid stem is as the family Cottidae.

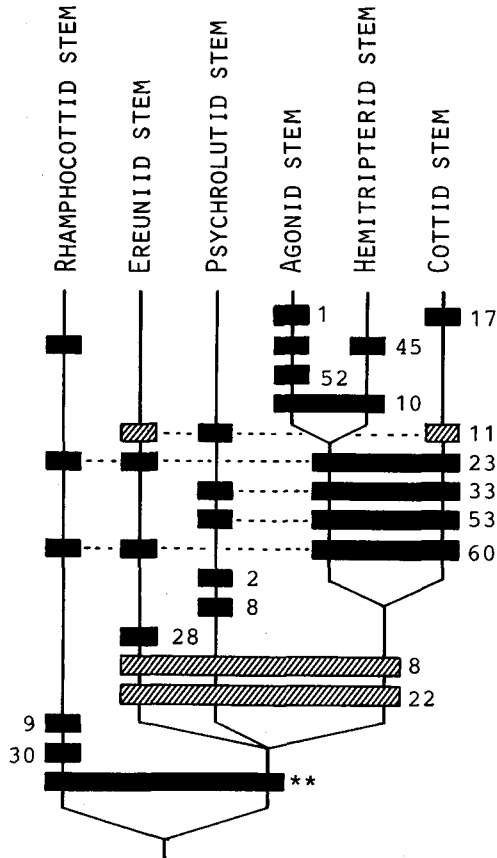

Fig. 52. Hypothetical branching pattern of six cottid stems. Solid square indicates the derived condition. Shaded square indicates the intermediated derived condition. The asterisked character indicates the synapomorphies of the superfamily Cottoidea. For explanation, see text.

4. BRANCHING PATTERN OF EACH COTTID FAMILIES

It seems that both characters and species examined here are not enough to discuss the phylogenetic relationships within each cottid family. However, it is necessary to infer the hypothetical branching patterns within each family in order to establish the classification of cottid fishes. Accordingly, the hypothetical branching patterns inferred on the basis of the characters examined here are shown. Because of the inconclusive data, the ranking of category lower than familial level is not made in this study.

1) FAMILY COTTIDAE (Figs. 53-58)

All cottid fishes are examined here are regarded as the derivatives from a common stem (the cottid stem). The cottid stem is characterized by having an autapomorphy which is the presence of the lateral process of the hyomandibular, and by having the combination of following synapomorphies; presence of a the pterosphenoid-parasphenoid junction, absence of a tooth plate on the third epibranchial, presence of two supratemporals, presence of six branchiostegal rays, absence of the stay behind last pterygiophore, presence of the rectus ventralis interconnecting between the urohyal and the third hypobranchial, presence of a narrow vertical bridge on the trigeminofacialis chamber, absence of the hyohyoideus inferioris, and absence of the coracoradialis. This stem includes the fishes of following cottid genera; *Jordania*, *Scorpaenichthys*, *Hemilepidotus*, *Cottus*, *Trachidermus*, *Leptocottus*, *Artedius*, *Chitonotus*, *Orthonopias*, *Triglops*, *Radulinus*, *Asemichthys*, *Astrocottus*, *Icelus*, *Ricuzenius*, *Stelgistrum*, *Thyriscus*, *Stlengis*, *Icelinus*, *Oligocottus*, *Clinocottus*, *Leiocottus*, *Synchirus*, *Gymnocanthus*, *Artediellus*, *Cottiusculus*, *Artediellichthys*, *Zesticelus*, *Ascelichthys*, *Taurocottus*, *Trichocottus*, *Myoxocephalus*, *Microcottus*, *Porocottus*, *Argyrocottus*, *Enophrys*, *Taurulus*, *Alcichthys*, *Bero*, *Ocynectes*, *Furcina*, *Pseudoblennius*, and *Vellitor*. These fishes are regarded as the members of a monophyletic group defined by the autapomorphy and the unique combination of the synapomorphies mentioned above.

Among the fishes of this monophyletic group, the following 22 characters are changed; the number of the infraorbitals (No. 1 in Table 14); the presence or the absence of teeth on the prevomer (No. 5); the condition of the palatocranial articulation (No. 6); the insertion of the Baudelot's ligament (No. 10); the condition of the entopterygoid (No. 15); the presence or the absence of teeth on the palatine (No. 16); the presence or the absence of the first pharyngobranchial (No. 19); the condition of the pharyngobranchial and its tooth plate (No. 20); the presence or the absence of the basihyal (No. 22); the condition of the scapula foramen (No. 24); the number of the actinosts (No. 26); the condition of the pectoral fin (No. 29); the number of the pelvic fin rays (No. 31); the insertion of the anterior pterygiophore of dorsal series (No. 32); the number of fin rays on the last anal pterygiophore (No. 34); the number of elements of the hypural-parhypural complex bone (No. 42); the condition of the neural spine on the preural centrum II (No. 43); the relation between the branchiostegal membranes and isthmus (No. 44); the condition of the body scales (No. 45); the position of the anus (No. 46); the condition of the obliquus superioris (No. 55); the condition of the adductor man-

dibulae section A2 (No. 59). On the basis of conditions of these characters, the fishes of this stem are classified into 34 morphotypes.

In the branching pattern shown in Fig. 53 which is the basal branches of the cottid fishes, *Jordania* is branched from the common stem of the other cottid fishes at the first branching point A, because it has no derived conditions of 22 characters. On the other hand, the common stem of other cottid fishes is characterized by having four synapomorphies; the absence of the first pharyngobranchial (No. 19), the absence of the basihyal (No. 11), the opened scapula foramen (No. 24), and the

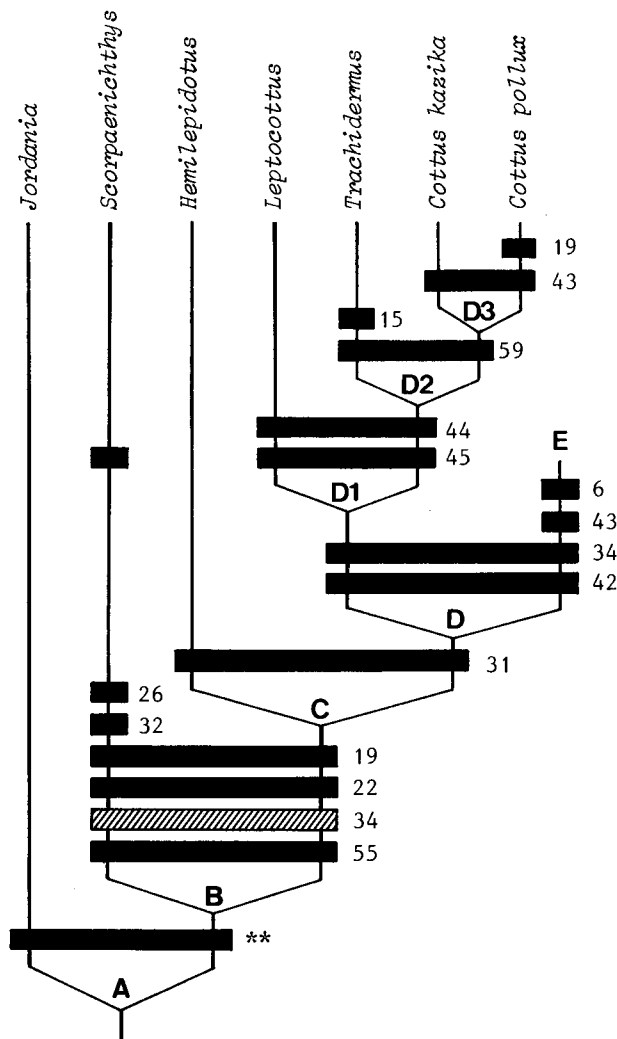

Fig. 53. Hypothetical branching pattern of 7 genera of the family Cottidae. A-E indicate branching points. The asterisked character indicates synapomorphies of this family. For explanation, see text.

obliquus superioris inserting to the cleithrum (No. 55). *Scorpaenichthys* is branched at the branching point B. This species has an autapomorphy which is the possession of three actinosts (No. 26). The derived conditions of two characters which are the first proximal pterygiophore of dorsal series inserting to the first interneural space (No. 32) and the body without ctenoid scales (No. 45) are regarded as homoplasies in this species. The common stem of the remaining species is characterized by a synapomorphy of four or less soft rays on the pelvic fin (No. 31).

Hemilepidotus is branched at the branching point C, but this species has no additional derived condition. On the other hand, the common stem of remaining species at the point C is characterized by two synapomorphies; a single ray on the last anal pterygiophore (No. 34), and the completely fused hypural-parhypural complex bone (No. 42). At the branching point D, the common stem of *Leptocottus*, *Trachidermus*, *Cottus kazika* and *Cottus pollux* is branched from the common stem of the remaining species. This common stem is characterized by having two synapomorphies; the branchiostegal membranes fused with the isthmus (No. 44), and reduced squamation on body (No. 45). *Leptocottus* is branched from the common stem at the branching point D1, but this species has no additional derived condition. The common stem of *Trachidermus* and *Cottus* has a synapomorphy of the condition of the adductor mandibulae section A2 (No. 59). *Trachidermus* is branched at the branching point D2 with the derived condition of the absence of the entopterygoid (No. 15). The remaining stem of *Cottus kazika* and *Cottus pollux* has

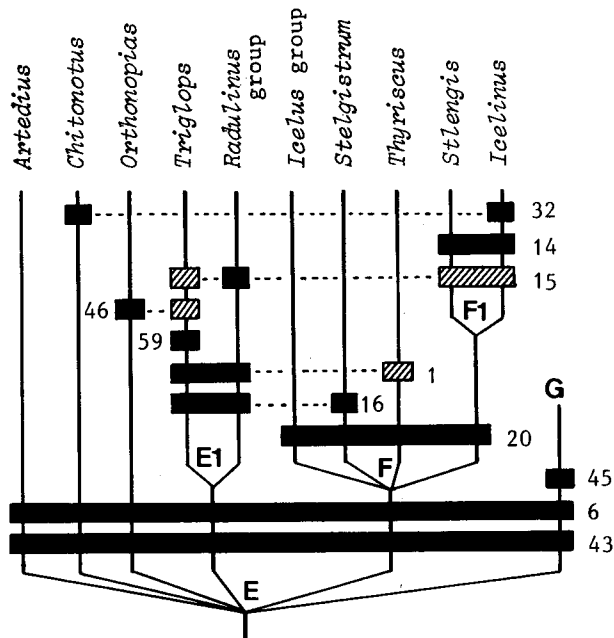

Fig. 54. Hypothetical branching pattern of 10 genera or genus groups of the family Cottidae. E-G indicate branching points. For explanation, see text.

a synapomorphy of long neural spine on the preural centrum II (No. 43). *Cottus pollux* is branched at the branching point D3 with a derived condition of the absence of teeth on the palatine (No. 19).

On the other hand, the common stem of the remaining species at the branching point D has two synapomorphies; the absence of the palatocranial articulation (No. 6), and a long neural spine on the preural centrum II (No. 43). At the next branching point E (Fig. 54), six groups can be branched. *Artedius* is branched at this point with no additional derived condition. *Chitonotus* is branched at this point with a derived condition of the anterior dorsal pterygiophore inserting to the first interspace (No. 32). *Orthonopias* is branched at this point with a derived condition of the anterior extension of the position of anus (No. 46). The common stem of *Triglops* and *Radulinus* group including *Radulinus*, *Asemichthys* and *Astrococtus* is branched at this branching point with three synapomorphies; four infraorbitals (No. 1), reduced entopterygoid or the absence of this bone (No. 15) and no teeth on palatine (No. 16). This common stem is divided into *Triglops*, which is characterized by having two derived conditions of the position of anus (No. 46) and condition of the adductor mandibulae section A2 (No. 59), and *Radulinus* group

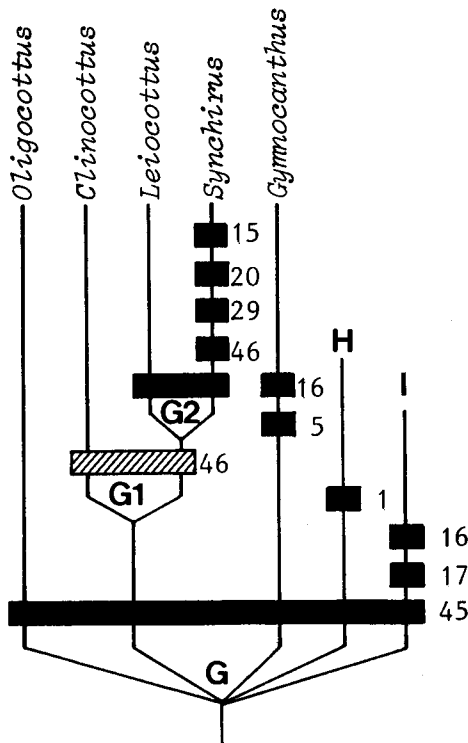

Fig. 55. Hypothetical branching pattern of 5 genera of the family Cottidae. G-I indicate branching points. For explanation, see text.

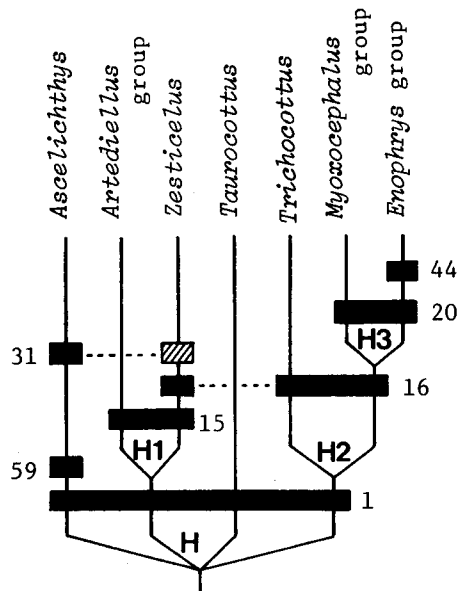

Fig. 56. Hypothetical branching pattern of 7 genera or genus groups of the family Cottidae. For explanation, see text.

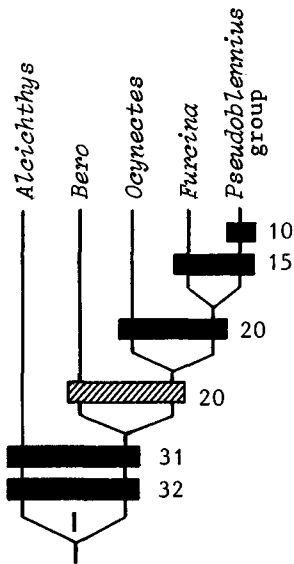

Fig. 57. Hypothetical branching pattern of 5 genera or genus group of the family Cottidae. For explanation, see text.

characterized by having a synapomorphy of absence of the entopterygoid (No. 15). The latter three genera show no difference as regarding the characters examined here. The common stem of *Icelus*, *Ricuzenius*, *Thyriscus*, *Stelgistrum*, *Stlengis* and *Icelinus* can be branched at the point E with a synapomorphy; one pharyngobranchial (No. 20). In this common stem, *Icelus* group including *Icelus* and *Ricuzenius* is branched at the branching point F without additional derived condition. *Thyriscus* is branched at the branching point F with a derived condition of four infraorbitals (No. 1), and *Stelgistrum* is branched at this point with a derived condition; no tooth on the palatine (No. 16). The common stem *Stlengis* and *Icelinus* is branched at the point F with two synapomorphies; reduced entopterygoid (No. 15) and two soft rays on pelvic fin (No. 14), then *Icelinus* is branched at F1 with anterior extension of the first dorsal pterygiophore (No. 32).

On the other hand, the common stem of the remaining species at the branching point E has a synapomorphy; reduced squamation on body (No. 45). This common stem is divided into five stems at the branching point G (Fig. 55). *Oligocottus* is branched at this point without additional derived condition. *Gymnocanthus* is branched at this point with two derived conditions; no teeth on the prevomer (No. 5) and no tooth on the palatine (No. 16). The common stem of *Clinocottus*, *Leiocottus* and *Synchirus* is branched at the point G with a synapomorphy; anterior extension of position of anus (No. 46). Then, the common stem of *Leiocottus* and *Synchirus* is branched with a synapomorphy of the palatine teeth (No. 16), while *Clinocottus* is branched without additional derived condition. In addition to above synapomorphy, *Synchirus* has four derived condition; no entopterygoid (No. 15), a single pharyngobranchial with a tooth plate (No. 20), pectoral fin fused its antimere on the ventral midline (No. 29), and anterior position of anus (No. 46).

The common stem of *Ascelichthys*, *Artediellus* group (*Artediellus*, *Artediellichthys*, *Cottiusculus*), *Zesticelus*, *Taurocottus*, *Trichocottus*, *Myoxocephalus* group (*Myoxocephalus*, *Microcottus*, *Porocottus*, *Argyrocottus*) and *Enophrys* group (*Enophrys* and *Taurulus*) is branched at the point G with a synapomorphy; four infraorbitals (No. 1). At the next branching point, this common stem can be derived into four stems. *Taurocottus* is branched at the point H (Fig. 56) but there is no additional derived condition. *Ascelichthys* is branched with three derived conditions; no fin ray element on the pelvic fin (No. 31), the branchiostegal membranes fused to the isthmus (No. 44), and the condition of the adductor mandibulae section A2 (No. 59). The common stem of *Artediellus* group and *Zesticelus* is branched with a synapomorphy of the reduced entopterygoid (No. 15), then *Zesticelus* is branched at the point

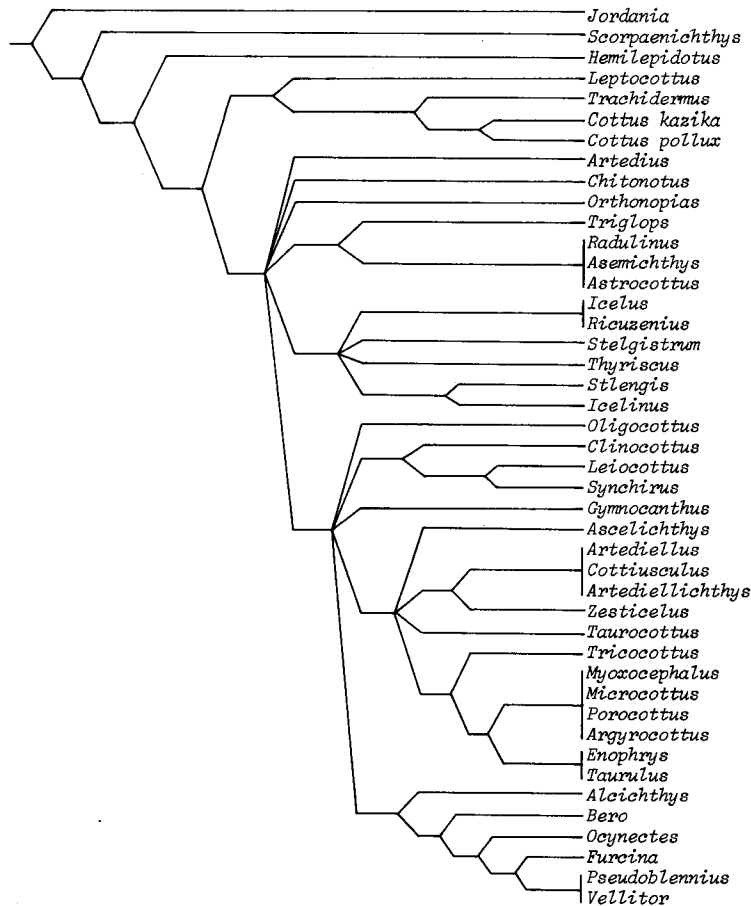

Fig. 58. Hypothetical branching pattern of 44 genera or species of the family Cottidae.

H1 with two derived conditions; no tooth on the palatine (No. 16) and two soft rays on pelvic fin (No. 31). The common stem of *Trichocottus*, *Myoxocephalus* group and *Enophrys* group is branched at the point H1 with a synapomorphy of no tooth on the palatine (No. 16). The common stem of *Myoxocephalus* and *Enophrys* groups is branched at the point H2 with a synapomorphy of a single pharyngobranchial with a tooth plate (No. 20), then *Enophrys* group is branched at the point H3 with a synapomorphy; the fusion of branchiostegal membranes to the isthmus (No. 44).

The common stem of *Alcichthys*, *Bero*, *Ocynectes*, *Furcina*, and *Pseudoblennius* group including *Pseudoblennius* and *Vellitor* can be branched at the point G with two synapomorphy; two soft rays on pelvic fin (No. 31), and the anterior dorsal pterygiophore inserting to the first interspace (No. 32). These fishes are continuously branched with each additional derived condition shown in Fig. 57; *Bero* with the loss of the tooth plate on the second pharyngobranchial (No. 20), *Ocynectes* with the loss of the second pharyngobranchial (No. 20), *Furcina* with a reduced entopterygoid

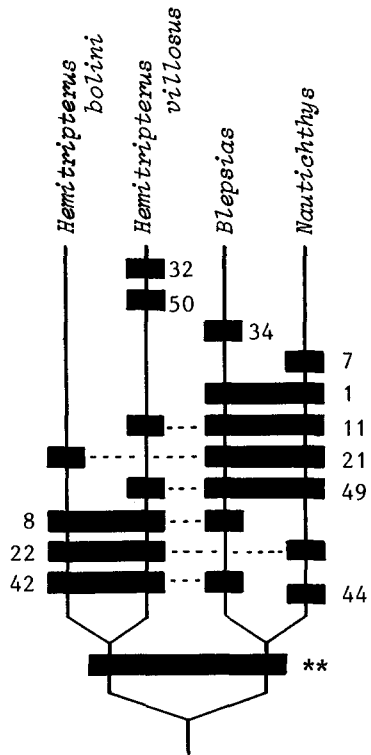

Fig. 59. Hypothetical branching pattern of 4 genera or species of the family Hemitripteridae. The asterisked character indicates synapomorphies of this family. For explanation, see text.

number of the pharyngobranchials (No. 20); the presence or absence of the tooth plate on the third epibranchial (No. 21); the condition of the anterior pterygiophore of the dorsal series (No. 32); the condition of the last ray of the anal fin (No. 34); the condition of the caudal fin rays (No. 42); the condition of the isthmus (No. 44); the presence or absence of the hyohyoideus inferior (No. 49); the condition of the transversus dorsalis (No. 50). The hypothetical branching pattern inferred on the basis of these characters is shown in Fig. 59.

According to this branching pattern, the common stem of *Hemitripterus bolini* and *Hemitripterus villosus* and that of *Blepsias* and *Nautichthys* are branched at the first branching point. The former stem is characterized by having the combination of three synapomorphies; a single pharyngobranchial with a tooth plate (No. 20), the trigeminofacialis chamber without the vertical bridge (No. 8) and unbranched caudal fin rays (No. 42). In addition to these synapomorphies, *Hemitripterus bolini* has a derived condition of the third epibranchial without tooth plate (No. 21), while *Hemitripterus villosus* has four derived conditions; two supratemporals (No. 11), the

(No. 15), and *Pseudoblennius* group with the Baudelot's ligament inserting to the first centrum (No. 10).

In conclusion, the hypothetical branching pattern of the family Cottidae is summarized in Fig. 58.

2) FAMILY HEMITRIPTERIDAE (Fig. 59)

The hemitripterid stem is regarded as the common stem from which all hemitripterid genera *Hemitripterus villosus*, *Hemitripterus bolini*, *Blepsias* and *Nautichthys* could be derived. This stem is characterized by an autapomorphous condition of the minute spines covering over the body, and the combination of the following synapomorphies; the absence of the basihyal, the Baudelot's ligament inserting to the first centrum, six branchiostegal rays, the presence of the rectus ventralis interconnecting the urohyal and the third hypobranchial, the absence of the stay. It, therefore, is considered that the fishes of above three genera are the members of a monophyletic group defined by above an autapomorphy and the combination of the synapomorphies. Among the fishes of these genera, following 12 characters are changed; the number of the infraorbitals (No. 1); the condition of the pterosphenoid-parasphenoid junction (No. 7); the condition of the trigeminofacialis chamber (No. 8); the condition of the supratemporals (No. 11); the number of the pharyngobranchials (No. 20); the presence or absence of the tooth plate on the third epibranchial (No. 21); the condition of the anterior pterygiophore of the dorsal series (No. 32); the condition of the last ray of the anal fin (No. 34); the condition of the caudal fin rays (No. 42); the condition of the isthmus (No. 44); the presence or absence of the hyohyoideus inferior (No. 49); the condition of the transversus dorsalis (No. 50).

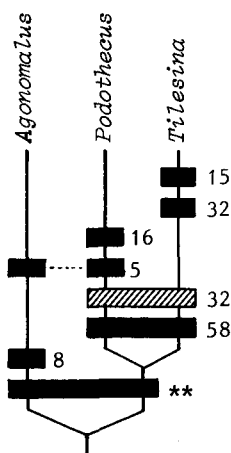

Fig. 60. Hypothetical branching pattern of 3 genera of the family Agonidae. Asterisk character indicates the synapomorphies of this family. For explanation, see text.

anterior extension of the first pterygiophore (No. 32), the absence of the hyohyoides inferioris (No. 49), and the transversus dorsalis inserting to the second and the third epibranchials (No. 50). The common stem of *Blepias* and *Nautichthys* is characterized by having the combination of four synapomorphies; four infraorbitals (No. 1), the third epibranchial without a tooth plate (No. 21), two supratemporals (No. 11) and absence of the hyohyoides inferioris (No. 49). Moreover, *Blepias* has three derived conditions which are the trigeminofacialis chamber without a vertical bridge (No. 8), a single ray of the last anal pterygiophore (No. 34), and unbranched caudal fin rays (No. 42). On the other hand, *Nautichthys* has other three derived conditions which are a single pharyngobranchial (No. 20), the presence of the pterosphenoid-parasphenoid junction (No. 7), and the branchiostegal membranes fused with the isthmus (No. 44).

3) FAMILY AGONIDAE (Fig. 60)

The agonid stem is regarded as the common stem from which the agonid genera *Agonomalus*, *Podothecus* and *Tilesina* could be derived. This stem is characterized by having three autapomorphous conditions; the bony plates covering over the body, the rectus ventralis II and three infraorbitals. In addition to these characters, this stem is also possessed of the following synapomorphies; presence of the pterosphenoid-parasphenoid junction, no teeth on the third epibranchial, six branchiostegal rays, the absence of the stay, the presence of the rectus ventralis interconnecting the urohyal and the third epibranchial, the Baudelot's ligament inserting to the first centrum, all fins composed of unbranched rays, and completely fused hypural complex. It, therefore, is considered that the fishes of these three genera are composed of a monophyletic group defined by having above autapomorphies and the combination of the synapomorphies.

In the present study, it is confirmed that six characters are changed in these fishes; the presence or the absence of teeth on the prevomer (No. 5); the condition of the trigeminofacialis chamber (No. 8); the condition of the entopterygoid (No. 15); the presence or the absence of the teeth on palatine (No. 16); the position of the anterior pterygiophore of the dorsal fin (No. 32); the anterior tendon of the adductor mandibulae section A1 (No. 58). The branching pattern inferred on basis of the these characters is shown in Fig. 60.

In this branching pattern, *Agonomalus* is branched from the common stem with two derived conditions; the trigeminofacialis chamber without a vertical bridge (No. 8), the absence of the prevomerine teeth (No. 5). On the other hand, *Podothecus* and *Tilesina* are possessed of two synapomorphous conditions of the anterior pterygiophore of dorsal fin (No. 32, this condition is the intermediate condition) and the anterior tendon of the adductor mandibulae (No. 58). *Podothecus* is branched

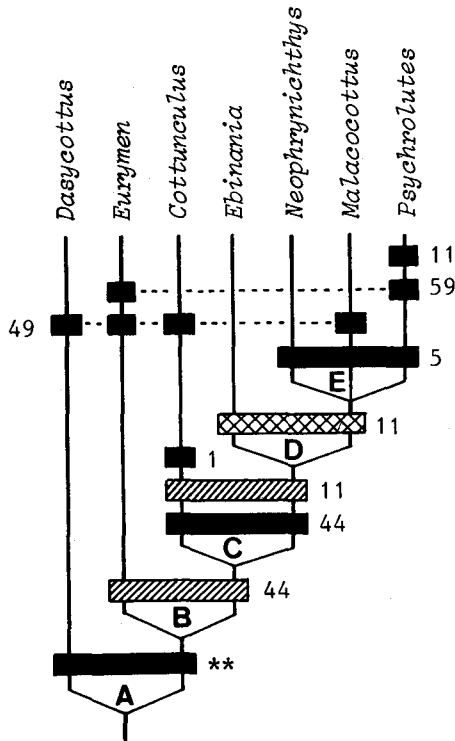

Fig. 61. Hypothetical branching pattern of 7 genera of the family Psychrolutidae. The asterisked character indicates synapomorphies of this family. For explanation, see text.

absence of the stay behind the last pterygiophore, the presence of the rectus ventralis interconnecting between the urohyal and the third hypobranchial and the absence of the basihyal. It, therefore, is considered that these seven genera are composed of a monophyletic group defined by above autapomorphies and the combination of the synapomorphies.

Among these fishes, six characters are changed; the number of the infraorbitals (No. 1); the presence or the absence of teeth on the prevomer (No. 5); the structure of the supratermporal commissure (No. 11); the condition of the isthmus (No. 44); the presence or the absence of the hyohyoides inferioris (No. 49); the condition of the adductor mandibulae section A2 (No. 59). The hypothetical branching pattern of the psychrolutid fishes inferred on the basis of above six characters is shown in Fig. 61.

In this branching pattern, *Dasycottus* is branched from the common stem of the psychrolutid fishes at the first branching point with a derived condition of the hyohyoides inferioris (No. 49). On the other hand, the common stem of the remaining fishes has a synapomorphy which is the intermediate derived condition of the isthmus (No. 44). At the second branching point, *Eurymen* is branched from the

from the common stem by having two derived conditions; the absence of the prevomerine teeth (No. 5), the absence of the palatine teeth (No. 16). On the other hand, *Tilesina* is branched from the common stem by having two derived conditions; a reduced entopterygoid (No. 15) and the anterior pterygiophore of the dorsal series inserting to the seventh interneurial space (No. 32).

4) FAMILY PSYCHROLUTIDAE (Fig. 61)

The psychrolutid stem is regarded as the main stem from which the fishes of genera *Dasycottus*, *Eurymen*, *Malaccottus*, *Cottunculus*, *Ebinania*, *Neophrynichthys* and *Psychrolutes* could be derived. The psychrolutid stem is characterized by having three autapomorphies; highly specialized supratermporal commissure of the sensory canal (see Fig. 13), the infraorbital sensory canal connected with the operculomandibular sensory canal, and the trigeminofacialis chamber without a vertical bridge. In addition to these autapomorphies, this stem is possessed of four synapomorphies; the absence of tooth plate on the third epibranchial, the

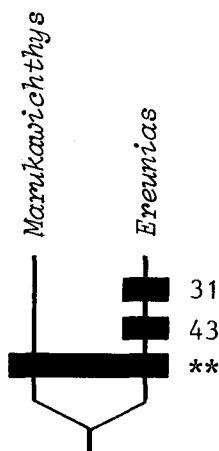

Fig. 62. Branch and character condition of of two genera of the family Ereuniidae. The asterisked character indicates synapomorphies of this family.

common stem with two derived conditions; the absence of the hyohyoideis inferioris (No. 49), and the adductor mandibulae section A2 connecting to the ligamentum primordium (No. 59). The remaining fishes have two synapomorphies which are the branchiostegal membranes completely fused to the isthmus (No. 44), and the intermediate derived condition of the supratemporal commissure (No. 11).

Cottunculus can be branched at the branching point C with two derived conditions; three infraorbitals (No. 1), and the absence of the hyohyoideis inferioris (No. 49). The common stem of *Ebinania*, *Neophrynichthys*, *Malacocottus* and *Psychrolutes* are characterized in having a derived condition of the supratemporal commissure (No. 11). In this common stem, *Neophrynichthys*, *Malacocottus* and *Psychrolutes* have a synapomorphy which is the absence of the prevomerine teeth (No. 5), while *Ebinania* has no additional derived condition. The former three genera can be tricotomously branched at the poin E. *Psychrolutes* has two derived conditions of the supratemporal commissure and the adductor mandibulae section A2 (No. 59), and *Malacocottus* has a derived condition of the hyohyoideis inferioris (No. 49), but *Neophrynichthys* has no additional derived condition.

5) FAMILY EREUNIIDAE (Fig. 62)

The ereuniid stem is regarded as the common stem from which two ereuniid genera *Marukawichthys* and *Ereunias* could be derived. This family is characterized by having an autapomorphy which is the free pectoral fin rays. In addition to this character, these fishes are possessed of the following synapomorphies; no basihyal, six branchiostegal rays, no tooth plate on the third epibranchial, the anteriormost pterygiophore of the dorsal series inserting to the first interspace, a single ray on last pterygiophore of dorsal and anal fins, completely fused hypural complex bone, and the obliquus superioris inserting to the cleithrum. Therefore these two genera are composed of the monophyletic group defined by above autapomorphy and the combination of the synapomorphies. On the other hand, the ereuniid fishes maintain a few primitive condition which are rarely distributed in the cottoid fishes; the presence of the suspensory pharyngeal, the absence of the rectus ventralis interconnecting between the urohyal and the third hypobranchial, and the presence of the stay of the last pterygiophore. In the common stem of the ereuniid fishes, *Marukawichthys* has no additional derived condition, while *Ereunias* has two derived conditions; the pelvic fin composed of one spine or no fin ray element (No. 31), and an elongated neural spine of the preural centrum II (No. 43).

6) FAMILY RHAMPHOCOTTIDAE

The rhamphocottid stem is regarded as the stem from which only *Rhamphocottus richardsoni* was derived. This family is characterized by having three autapomorphies; the presence of the basioccipital-parasphenoid fossa, the unique form of pelvis and its muscular system, and small multifid spines covering over the body. In addition to these characters, *Rhamphocottus* is possessed of the following derived conditions; four infraorbitals, no tooth on the palatine, six branchiostegal rays, no tooth plate on the third epibranchial, all fins composed of unbranched rays, the presence of pterosphenoid-parasphenoid junction, and completely fused hypural complex. It, therefore, is considered that *Rhamphocottus* is composed of an independent monophyletic group defined by the above autapomorphies and the combination of the derived condition of characters.

5. GENERAL CONSIDERATION

As the results of the phylogenetic analysis on the basis of the osteological and myological comparison, six monophyletic groups corresponding to the familial level are recognized in the superfamily Cottoidea. They are the Rhamphocottidae, the Psychrolutidae, the Ereuniidae, the Agonidae, the Hemitripterae and the Cottidae. The family Rhamphocottidae has been placed in a member of the family Cottidae (Gunther, 1880; Regan, 1913; Berg, 1940; Greenwood et al., 1966; Nelson, 1976). On the other hand, this family has been regarded as the highly specialized cottoid family (Jordan and Starks, 1895; Johnson, 1918; Taranetz, 1941), and moreover, as the independent superfamily (Gill, 1888). In the present study, it is considered that the Rhamphocottid stem is regarded as the first branch of the common stem of the cottoid fishes, and as a group specialized independently after divided from the common stem. The fishes of family Psychrolutidae have been included as two independent families Cottunculidae and Psychrolutidae (Regan, 1913; Berg, 1940; Greenwood et al., 1966; Nelson, 1976), as a cottoid family Psychrolutidae (Taranetz, 1941; Nelson, 1982) or as the family Cottidae (Watanabe, 1958; Stein and Bond, 1978). On the other hand, two psychrolutid genera *Dasycottus* and *Malacocottus* have been regarded as the members of the family Cottidae, while other members as the family Psychrolutidae (Matsubara, 1955). In the present study, this family is regarded as a monophyletic group well defined by unique synapomorphies. This conclusion is in accord with opinion of Taranetz (1941) and Nelson (1982). The members of family Ereuniidae have been included as the family Icelidae with a cottid genus *Icelus* (Berg, 1940; Greenwood et al., 1966; Nelson, 1976), or two families Marukawichthyidae and Ereuniidae (Taranetz, 1941). Matsubara (1936 and 1955) regarded this family as a subfamily of the Cottidae. But, Yabe (1981) reexamined this family and established the family Ereuniidae on the basis of the osteological study. In the present study, the validity of this family is confirmed from the osteological and myological characters.

The family Agonidae has been regarded as one of the cottoid families (Regan, 1913; Berg, 1940; Taranetz, 1941, Greenwood et al., 1966; Nelson, 1976), or as the independant superfamily with two families which are Agonidae and Aspidophoridae (Gill, 1888; Matsubara, 1955). In the present study, this family is recognized as one of the cottoid families and as the group closely related to the family Hemitripterae. The fishes of the family Hemitripterae have been considered as

the members of the family Cottidae (Ragan, 1913; Berg, 1940; Matsubara, 1955; Greenwood et al., 1966; Nelson, 1966). Matsubara (1955) regarded *Hemitripterus* as the subfamily Hemitripterinae, and *Blepsias* and *Nautichthys* as the subfamily Blepsinae in the family Cottidae. According to Taranetz (1941), *Hemitripterus* is regarded as the member of the family Hemitripteridae, *Blepsias* is as that of the family Blepsidae, and *Nautichthys* is as that of the family Cottidae. In the present study, it is considered that these three genera are the members of a monophyletic group defined by unique combination of synapomorphies. In the classification of the cottoid fishes made by Taranetz (1941), the family Cottidae in the present study was divided into three families (Ascelichthyidae, Synchronidae and Cottidae), and *Scorpaenichthys* was regarded as the nototheniform member. It, however, is considered that *Ascelichthys*, *Synchirus* and *Scorpaenichthys* are the members of the family Cottidae, because they are possessed of all synapomorphies in common with other members of Cottidae while they have unique derived conditions respectively. Thus, it is reasonable to consider that these fishes are unique derivatives from the cottid common ancestor.

The cyclopterid and the liparidid fishes have been regarded as one of the cottoid families in some studies (Regan, 1913; Berg, 1940; Greenwood et al., 1966; Nelson, 1976). It has been considered that the cyclopterid fishes are closely related to the psychrolutid fishes (Matsubara, 1943; Ueno, 1970). As a result of the present study, it is satisfactory to consider that the cyclopterid and the liparidid fishes are composed of a monophyletic group which is the sister group of the superfamily Cottoidea.

The fishes of the families Normanichthyidae, Abyssocottidae and Comephoridae could not be examined in the present study. According to the description of the osteology and the cephalic sensory canal made by Taliev (1955) and Sideleva (1982), the fishes of the families Abyssocottidae and Comephoridae possess the trigeminofacialis chamber with a vertical bridge, the completely fused hypural complex, and the infraorbital sensory canal not connected with the operculomandibular sensory canal. Regarding these characters both families agree with the family cottidae of the present study. But other osteological and the myological condition have not been shown. Moreover, the anatomical data of the family Normanichthyidae has scarcely been known. It is impossible to discuss the phylogenetic positions of these families. Thus, these families are regarded as the independent families as a matter of convenience.

A new classification of the superfamily Cottoidea proposed in the present study is shown below. The asterisked genera are not examined in this study. The systematic positions of these fishes conform to the previous studies.

Superfamily Cottoidea

Family Rhamphocottidae

Genus *Rhamphocottus*

Family Ereuniidae

Genera *Marukawichthys*, *Ereunias*

Family Psychrolutidae

Genera *Dasycottus*, *Eurymen*, *Cottunculus*, *Ebinania*, *Malacocottus*,

*Psychrolutes, Neophrynichthys, Gilbertidia**

Family Agonidae

Genera *Agonomalus, Podothecus, Tilesina, Agonopsis**, *Agonus**, *Anoplagonus**, *Aspidophoroides**, *Asterotheca**, *Bathyagonus**, *Bothragonus**, *Brachyopsis**, *Hypsagonus**, *Leptagonus**, *Occella**, *Odontopyxis**, *Pallasina**, *Percis**, *Sarritor**, *Stellerina**, *Xeneretmus**

Family Hemitripterae

Genera *Hemitripterus, Blepsias, Nautichthys*

Family Cottidae

Genera *Jordania, Scorpaenichthys, Hemilepidotus, Leptocottus, Trachidermus, Cottus, Artedius, Chitonotus, Orthonopias, Triglops, Radulinus, Asemichthys, Astrocottus, Icelus, Ricuzenius, Stelgistrum, Thyriscus, Stlengis, Icelinus, Oligocottus, Clinocottus, Leiocottus, Synchirus, Gymnocanthus, Ascelichthys, Artediellus, Artediellichthys, Cottiusculus, Zesticelus, Taurocottus, Trichocottus, Myoxocephalus, Microcottus, Argyrocottus, Porocottus, Enophrys, Taurulus, Alcichthys, Bero, Ocynectes, Furcina, Pseudoblennius, Vellitor, Antipidocottus*, Archistes*, Atopocottus*, Batrachocottus*, Cottocomephorus*, Daruma*, Megalocottus*, Paracottus*, Paricelinus*, Phallocottus*, Phasmatocottus*, Stlengicottus*, Sigmistes**

Family Comephoridae (sensu Taliev, 1955)

Genus *Comephorus**

Family Abyssocottidae (sensu Sideleva, 1982)

Genera *Abyssocottus**, *Asprocottus**, *Cottinella**, *Limnocottus**, *Neocottus**, *Procottus**

Family Normanichthyidae (sensu Berg, 1940)

Genus *Normanichthys**

VIII. Summary

The present study was made to elucidate the monophyly of the superfamily Cottoidea and the interrelationships of the cottoid fishes and to establish the phylogenetic classification in this superfamily. The specimens of 78 species of 59 genera of the superfamily Cottoidea and 24 species of 11 families of other scorpaeniform fishes were used for the study of comparative anatomy. Twelve skeletal parts and eleven muscular parts of each specimen were examined; circumorbital bones, cranium, jaws, suspensorium and opercular bones, hyoid apparatus, branchial apparatus, pectoral girdle, pelvic girdle, postcranial axial skeleton, median fin support, caudal skeleton, scales, muscles of cheek, hyoid muscles, branchial muscles, pectoral muscles, pelvic muscles, body muscles, muscles of caudal fin, muscles of swimbladder, and muscles between pectoral girdle and cranium, hyoid arch and branchial arch. The 60 characters of their parts were selected for the establishment of the above purposes. The polarity of the character was determined by the basic assumption that the ancestral condition of each character in the cottoid fishes is

represented by the condition in the generalized percoid fishes. The phylogenetic relationships in the superfamily was inferred on the basis of the conception of the synapomorphy proposed by Hennig (1966). The monophyletic group is recognized not only by the autapomorphy but also unique combination of synapomorphies. The conclusion of the present study are summarized as follows.

(1) The superfamily Cottoidea is regarded as a monophyletic group defined by the combination of 22 synapomorphies; the hyohyoides abductor is fused with its antimere, the levator externus III is absent, the extensor proprius is absent, the extrinsic muscle interconnects the cranium and the cleithrum, the adductor of the caudal muscle is absent, the suborbital stay is present, the lachryopalatine articulation is present, the intercalar is present as a small bone, the basisphenoid is absent, the posttemporal fossa is not developed, the basihyal is present as a tiny bone or absent, the metapterygoid lamina is absent, the fourth pharyngobranchial is absent, the scapula foramen is not completely closed, the scapula is not attached with the coracoid, the spiny anal ray is absent, the pleural and epiplural ribs are attached to the centrum, the first pleural rib begins at the sixth centrum or more posterior, the haemal spine on the preural centrum II is fused with the centrum, the hypurapophysis is absent, and the hypural-parhypural complex bone is composed of one or two elements.

(2) The phylogenetic relationships of the cottoid fishes are shown in Fig. 52. Six families, Cottidae, Hemitripterae, Agonidae, Ereuniidae, Psychrolutidae, and Rhamphocottidae, are recognized in the superfamily, because they are regarded as monophyletic groups defined by the autapomorphies and combination of the synapomorphies.

(3) The family Cottidae is regarded as a monophyletic group defined by one autapomorphy which is the presence of the lateral process of the hyomandibular, and the combination of nine synapomorphies. This family includes 43 examined genera; *Jordania*, *Scorpaenichthys*, *Hemilepidotus*, *Cottus*, *Trachidermus*, *Leptocottus*, *Artedius*, *Chitonotus*, *Orthnopias*, *Triglops*, *Radulinus*, *Asemichthys*, *Astrocottus*, *Icelus*, *Recuzenius*, *Stelgistrum*, *Thyriscus*, *Stelngis*, *Icelinus*, *Oligocottus*, *Clinocottus*, *Leiocottus*, *Synchirus*, *Gymnocanthus*, *Artediellus*, *Cottiusculus*, *Artediellichthys*, *Zesticelus*, *Ascelichthys*, *Taurocottus*, *Trichocottus*, *Myoxocephalus*, *Microcottus*, *Porocottus*, *Argyrocottus*, *Enophrys*, *Taurulus*, *Alcichthys*, *Bero*, *Ocynectes*, *Furcina*, *Pseudoblennius*, and *Vellitor*. Among these genera, *Jordania* is regarded as the earliest derivative in this family.

(4) The family Hemitripterae is regarded as a monophyletic group defined by one autapomorphy which is minute spine covering over the body, and the combination of seven synapomorphies, and as the sister group of the family Agonidae. This family includes three examined genera *Hemitripterus*, *Blepsias* and *Nautichthys*.

(5) The family Agonidae is regarded as a monophyletic group defined by three autapomorphies which are the presence of rectus ventralis II, three infraorbitals and the bony plates covering over the body, and by the combination of eight synapomorphies, and as closely related to the family Hemitripterae. This family includes three examined genera *Agonomalus*, *Podothecus* and *Tilesina*.

(6) The family Psychrolutidae is regarded as a monophyletic group defined by

two autapomorphies which are the infraorbital sensory canal connected with the operculomandibular sensory canal and the highly specialized supratemporal commissure, and by the combination of four synapomorphies. This family includes seven examined genera *Dasycottus*, *Eurymen*, *Malacocottus*, *Cottunculus*, *Ebinania*, *Neophrynichthys*, and *Psychrolutes*.

(7) The family Ereuniidae is regarded as a monophyletic group defined by an autapomorphy which is the free pectoral fin rays, and by seven synapomorphies. This family includes two examined genera *Marukawichthys* and *Ereunias*.

(8) The family Rhamphocottidae including a single species *Rhamphocottus richardsoni* is a monophyletic group defined by three autapomorphies; the presence of the basioccipital-parasphenoid fossa, the unique form of the pelvis and its muscles, and small multifid spines covering over the body. This family is considered as the earliest derivative with peculiar specializations in this superfamily.

(9) The fishes of the family Cyclopteridae and the Liparididae are regarded as the monophyletic group which is the sister group of the superfamily Cottoidea.

IX. Literature cited

- Adamicka, V.P. 1972. Funktionsanatomische Untersuchungen am Kopf von Akanthopterygien (Pisces, Teleostei): *Sarda sarda*, *Pterois volitans*, *Chysophrys aurata*. Teil II: *Pterois volitans*. *Zool. Jb. Anat.*, **89**: 422-451.
- Alexander, R.M. 1967. The functions and mechanisms of the protrusible upper jaws of some acanthopterygian fishes. *J. Zool., Lond.*, **151**: 43-64.
- Allis, E.P. 1909. The cranial anatomy of the mail-cheeked fishes. *Zoologica*, **22**: 1-219, pls. 1-5.
- Anker, G.C. 1978. The morphology of the head-muscles of a generalized haplochromis species: *H. elegans* Trewavas 1933 (Pisces, Cichlidae). *Neth. J. Zool.*, **28**(2): 234-271.
- Ashlock, P.H. 1971. Monophyly and associated terms. *Syst. Zool.*, **20**(1): 63-69.
- Barber, S.B. and W.H. Mowbray. 1956. Mechanism of sound production in the sculpin. *Science*, **124**: 219-220.
- Berg, L.S. 1940. Classification of fishes, both recent and fossil. *Tr. Inst. Zool. Akad. Nauk. SSSR*, **5**(2): 87-517.
- Bolin, R.L. 1936a. A revision of the genus *Icelinus* Jordan. *Copeia*, **1936**(3): 151-159.
- Bolin, R.L. 1936b. Two new cottid fishes from the western Pacific, with a revision of the genus *Stlengis* Jordan and Starks. *Proc. U.S. Nat. Mus.*, **83**(2987): 326-334.
- Bolin, R.L. 1944. A review of the marine cottid fishes of California. *Stanford Ichthyol. Bull.*, **3**(1): 1-135.
- Bolin, R.L. 1947. The evolution of the marine cottidae with a discussion of the genus as a systematic category. *Ibid.*, **3**(3): 153-158.
- Branson, B.A. and G.A. Moore. 1962. The lateralis components of the acoustico-lateralis system in the sunfish family Centrarchidae. *Copeia*, **1962**(1): 1-108.
- Camín, J.H. and R.R. Sokal. 1965. A method for deducing branching sequences in phylogeny. *Evolution*, **19**: 311-326.
- Cowan, G.I.M. 1969. The cephalic and caudal musculature of the sculpin *Myoxocephalus polyacanthocephalus* (Pisces: Cottidae). *Can. J. Zool.*, **47**(5): 841-850.
- Cowan, G.I.M. 1971. Comparative morphology of the cottid genus *Myoxocephalus* based on meristic, morphometric and other anatomical characters. *Ibid.*, **49**(11): 1479-1496.
- Cowan, G.I.M. 1972. Relationships within the genus *Myoxocephalus* (Pisces: Cottidae) based on morphological and biochemical data using numerical and conventional method of analyses. *Ibid.* **50**(5): 671-682.
- Davis, W.P. and R.S. Birdsong. 1973. Coral reef fishes which forage in the water column. A review

- of their morphology, behavior, ecology and evolutionary implications. *Helgol. Wiss. Meeresunters.*, **24**: 292-306.
- Dietz, P.A. 1914. Beitrage zur Kenntnis der Kiefer und Kiemenbogenmuskulatur der Teleostier. *Mitt. Statziona Zoologica Neapel*, **22**(4): 99-162.
- Dineen, C.F. and P.S. Stokely. 1956. The osteology of the Sacramento perch, *Archoplites interruptus* (Girard). *Copeia*, **1956**(4): 217-230.
- Elshoud-Oldenhave, M.J. and J.W.M. Osse. 1976. Functional morphology of the feeding system in the ruff, *Gymnocephalus cernus* (L. 1958), (Teleostei, Percidae). *J. Morphol.*, **150**(2): 399-422.
- Evans, R.R. 1973. The swimbladder and associated structures in western Atlantic sea robins (Triglidae). *Copeia*, **1973**(2): 315-321.
- Farris, J.S. 1970. Methods for computing Wagner trees. *Syst. Zool.*, **19**(1): 83-92.
- Fish, M.P. 1954. The character and significance of sound production among fishes of the western North Atlantic. *Bull. Bingham Oceanogr. Collect., Yale Univ.*, **14**(3): 3-109.
- Freihofer, W.C. 1963. Patterns of ramus lateralis accessorius and their systematic significance in teleostean fishes. *Stanford Ichthyol. Bull.*, **8**(2): 80-189.
- Freihofer, W.C. 1978. Cranial nerves of a percoid fish, *Polycentrus schomburkii* (family Nandidae), a contribution to the morphology and classification of the order Perciformes. *Occas. Pap. Calif. Acad. Sci.*, (128): 1-78.
- Ganguly, D.N. and W. Majumdar. 1962. On the functional morphology of the myomeric musculature of some littoral benthonic teleostean fishes. *Anat. Anz.*, **112**: 289-316.
- Geerlink, P.J. 1979. The anatomy of the pectoral fin in *Sarotherodon niloticus* Trewavas. *Neth. J. Zool.*, **29**(1): 9-32.
- Gill, T. 1889. On the classification of the mail-cheeked fishes. *Proc. U.S. Nat. Mus.*, **11**: 567-592.
- Girard, C.F. 1852. Contributions to the natural history of the freshwater fishes of North America. I. A monograph of the cottoids. *Smithson. Contrib. Knowl.*, **3**(3): 1-80, pls. 1-3.
- Goodrich, E.S. 1930. *Studies on the structure and development of vertebrates*. Reprint, Dover Publications Inc., New York, 1958, lxxix+837 pp.
- Gosline, W.A. 1961a. The perciform caudal skeleton. *Copeia*, **1961**(1): 265-270.
- Gosline, W.A. 1961b. Some osteological features of modern lower teleostean fishes. *Smith. Misc. Coll.*, **142**(3): 1-42.
- Gosline, W.A., 1966. The limits of the fishes family Serranidae, with notes on other lower percoids. *Proc. Calif. Acad. Sci., 4th Ser.*, **33**(6): 91-112.
- Gosline, W.A. 1971. *Functional morphology and classification of fishes*. Univ. Press Hawaii, Honolulu, ix+208 pp.
- Greenwood, P.H. 1971. Hyoid and ventral gill arch musculature in osteoglossomorph fishes. *Bull. Br. Mus. (Nat. Hist.) Zool.*, **22**(1): 1-55.
- Greenwood, P.H. 1981. The protractor pectoralis muscle and the classification of the teleost fishes. *Ibid.*, **41**(4): 213-234.
- Greenwood, P.H., D.E. Rosen, S.H. Weitzman, and G.. S. Myers. 1966. Phyletic studies of teleostean fishes, with a provisional classification of living forms. *Bull. Amer. Mus. Nat. Hist.*, **131**(4): 339-456, pls 21-23.
- Gregory, W.K. 1933. Fish skull: A study of the evolution of natural mechanism. *Trans. Amer. Philos. Soc.*, **23**(2): i-vii+75-481.
- Gutberlet, J.E. 1915. On the osteology of some of the Loricati. *Ill. Biol. Monogr.*, **2**(2): 1-40, pls. 1-5.
- Hallacher, L.E. 1974. The comparative morphology of extrinsic gasbladder musculature in the scorpionfish genus *Sebastes* (Pisces: Scorpaenidae). *Proc. Calif. Acad. Sci.*, **15**(3): 59-84.
- Harrington, R.W., Jr. 1955. The osteocranium of the American cyprinid fish, *Notropis bifrenatus*, with an annotated synonymy of teleost skull bones. *Copeia*, **1955**(4): 267-290.
- Hazlett, B. and E. Winn. 1962. Sound producing mechanism of the nassau grouper *Epinephelus striatus*. *Ibid.*, **1962**(2): 447-449.
- Hecht, M.K. and J.L. Edwards. 1977. The methodology of phylogenetic inference above the species level. pp. 3-51, in M.K. Hecht, P.C. Goody and B.M. Hecht, (ed.), *Major patterns in*

- vertebrate evolution*. Plenum, New York. ix+908 pp.
- Hennig, W. 1966. *Phylogenetic systematics*. Univ. Illinois Press, Urbana, 263 pp.
- Holstvoogd, C. 1965. The pharyngeal bones and muscles in teleostei, a taxonomic study. *Proc. K. Ned. Akad. Wet., Ser. C*, 63(3): 209-218.
- Houde, E.D. and Potthoff, T. 1976. Egg and larval development of the sea bream *Archosargus rhomboidalis* (Linnaeus), Pisces, Sparidae. *Bull. Mar. Sci.*, 26(4): 506-529.
- Howes, G.J. 1976. The cranial musculature and taxonomy of characoid fishes of the tribes Cynodontini and Characini. *Bull. Br. Mus. (Nat. Hist.) Zool.*, 29(4): 201-248.
- Howes, G.J. 1980. The anatomy, phylogeny and classification of bariliine cyprinid fishes. *Ibid.*, 37(3): 129-198.
- Ilyina, M.B. 1978. On the systematic status of the genus *Podothecus* Gill in the family Agonidae. pp. 13-24, in L. V. Shorenkova, (ed.), *Morphology and systematic of fishes*. Zool. Inst., Akad. Nauk. SSSR, Leningrad, 87 pp. (In Russian)
- Jordan, D.S. and B.W. Evermann. 1898. The fishes of North and Middle America. Part 2. *Bull. U.S. Nat. Mus.*, 47: 1241-2183.
- Jordan, D.S. and E.C. Starks. 1904. A review of the cottidae or sculpins found in the waters of Japan. *Proc. U.S. Nat. Mus.*, 27(1358): 231-335.
- Johnson, G.D. 1980. The limits and relationships of the Lutjanidae and associated families. *Bull. Scripps Inst. Oceanog., Univ. Calif.*, 24: 1-114.
- Johnson, G.D. 1983. *Niphon spinosus*: A primitive epinepheline serranid, with comments on the monophyly and intrarelationships of the Serranidae. *Copeia*, 1983(3): 777-787.
- Johnson, S.J. 1918. Osteology of the gruntfish, *Rhamphocottus richardsoni*. *J. Morphol.*, 31(3): 461-487.
- Kanayama, T. 1977. Comparative osteology, phylogeny and zoogeography of the family Agonidae. M.S. thesis, Hokkaido University, 152 pp. (In Japanese).
- Katayama, M. 1952. Systematic position of *Doderleinia berycoides* (Hirgendorf) and *Synagrops japonicus* (Steindachner et Doderlein). *Japan. J. Ichthyol.*, 2(3): 104-110. (In Japanese).
- Katayama, M. 1959. Studies on the serranid fishes of Japan (1). *Bull. Fac. Ed., Yamaguchi Univ.*, 8: 103-180.
- Kendall, A.W. Jr. 1976. Predorsal and associated bones in serranid and grammatid fishes. *Bull. Mar. Sci.*, 26(4): 585-592.
- Kershaw, D.R. 1976. A structural and functional interpretation of the cranial anatomy in relation to the feeding of osteoglossoid fishes and a consideration of their phylogeny. *Trans. Zool. Soc. Lond.*, 33(3): 173-252.
- Kluge, A.G. and J.S. Farris. 1969. Quantitative phyletics and the evolution of anurans. *Syst. Zool.*, 18(1): 1-32.
- Lauder, G.V. and K.F. Liem. 1983. The evolution and interrelationships of acanthopterygian fishes. *Bull. Mus. Comp. Zool.*, 150(3): 95-197.
- Liem, K.F. 1970. Comparative functional anatomy of the Nandidae (Pisces: Teleostei). *Feldiana: Zool.*, 56: 1-166.
- Liem, K.F. 1978. Modulatory multiplicity in the functional repertoire of the feeding mechanism in cichlid fishes. *J. Morphol.*, 158: 323-360.
- Liem, K.F. 1981. A phyletic study of the Lake Tanganyika cichlid genera *Asprotilapia*, *Ectodus*, *Lestrades*, *Cunningtonia*, *Ophthalmochromis*, and *Ophthalmotilapia*. *Bull. Mus. Comp. Zool.*, 149(3): 191-241.
- Liem, K.F. and P.H. Greenwood. 1981. A functional approach to the phylogeny of the pharyngognath teleost. *Amer. Zool.*, 21: 83-101.
- Litvinenko, N.I. 1980. The structure function and origin of tympanic muscle in the North Atlantic redfishes of the genus *Sebastes* (Scorpaenidae). *J. Ichthyol.*, 20(5): 866-876.
- Matsubara, K. 1936. A review of two genera of the Japanese sculpins, *Ereunias* and *Marukawichthys* with special reference to their systematic position. *J. Imp. Fish. Inst., Tokyo*, 31(2): 97-114.
- Matsubara, K. 1943. Studies on the scorpaenoid fishes of Japan. Anatomy, phylogeny and taxon-

- omy (I). *Trans. Sigenkagaku Kenkyusho*, (1): 1-170.
- Matsubara, K. 1955. *Fish morphology and hierarchy*. Ishizaki Shoten, Tokyo, xi+v+1605+viii pp., 135 pls. (In Japanese).
- Matsubara, K. and A. Ochiai. 1955. A revision of the Japanese fishes of the family Platycephalidae (the flatheads). *Mem. Coll. Agri., Kyoto Univ.*, (68): 1-109.
- Matsuura, K. 1979. Phylogeny of the superfamily Balistoidea (Pisces: Tetradontiformes). *Mem. Fac. Fish. Hokkaido Univ.*, 26(1/2): 49-169.
- McAllister, D.E. 1968. The evolution of branchiostegals and associated opercular, gular, and hyoid bones and the classification of teleostome fishes, living and fossil. *Mus. Canada Bull.*, (211), *Biol. Ser.*, (77): i-xiv+1-239, pls. 1-21.
- Monod, T. 1968. Le complex urophore des poissons teleosteens. *Mem Inst. Fondamental Afrique Noire*, (81): 1-705.
- Nag, A.C. 1967. Functional morphology of the caudal region of certain clupeiform and perciform fishes with reference to the taxonomy. *J. Morphol.*, 123(4): 529-558.
- Neelov, A.V. 1976. Survey of the fringed sculpins of the genus *Porocottus* Gill and closely related genera (Cottidae, Myoxocephalinae). pp. 78-112, in V. M. Korovina, (ed.), *Zoogeography and systematics of fishes*. Zool. Inst., Akad. Nauk. SSSR, Leningrad, 195 pp. (In Russian).
- Neelov, A.V. 1979. *Seismosensory system and the classification of sculpins (Cottidae: Myoxocephalinae, Artediiellinae)*. Zool. Inst., Akad. Nauk. SSSR, Leningrad, 208 pp. (In Russian).
- Nelson, G.J. 1967. Branchial muscles in some generalized teleostean fishes. *Acta Zoologica*, 48: 277-288.
- Nelson, G.J. 1969. Gill arches and phylogeny of fishes, with note on the classification of vertebrates. *Bull. Amer. Mus. Nat. Hist.*, 141(4): 477-552, pls. 79-384.
- Nelson, G.J. 1970. Outline of a theory of comparative biology. *Syst. Zool.*, 19(4): 373-384.
- Nelson, J.S. 1976. *Fishes of the world*. Wiley-Interscience, New York, xiii+416 pp.
- Nelson, J.S. 1982. Two new south pacific fishes of the genus *Ebinania* and contributions to the systematics of Psychrolutidae (Scorpaeniformes). *Can. J. Zool.*, 60: 1470-1504.
- Nursall, J.R. 1963a. The caudal musculature of *Hoplopogrus guntheri* Gill (Perciformes: Lutjanidae). *Ibid.*, 41: 865-880.
- Nursall, J.R. 1963b. The hypurapophysis, an important element of the caudal skeleton. *Copeia*, 1963(2): 458-459.
- Osse, J.W.M. 1969. Functional morphology of the head of the perch (*Perca fluviatilis* L.): An electromyographic study. *Neth. J. Zool.*, 19: 289-392, pls. 1-15.
- Patterson, C. 1964. A review of mesozoic acanthopterygian fishes, with special reference to those of the English chalk. *Phil. Trans. Roy. Soc. London, Ser. B*, noz 739, 247: 213-482, pls. 2-5.
- Patterson, C. 1968. The caudal skeleton in Mesozoic acanthopterygian fishes. *Bull. Br. Mus. (Nat. Hist.) Geol.*, 17(2): 49-102.
- Peden, A.E. 1978. A systematic revision of the hemilepidotine fishes (Cottidae). *Syesis*, 11: 11-49.
- Potthoff, T. 1975. Development and structure of the caudal complex, the vertebral column, and the pterygiophores in the blackfin tuna (*Thunnus atlanticus*, Pisces, Scombridae). *Bull. Mar. Sci.*, 25(2): 205-231.
- Potthoff, T., W.J. Richards and S. Ueyanagi. 1980. Development of *Scombrolabrax heterolepis* (Pisces, Scombrolabracidae) and comments on familial relationships. *Bull. Mar. Sci.*, 30(2): 329-357.
- Quast, J.C. 1965. Osteological characteristics and affinities of the hexagrammid fishes, with a synopsis. *Proc. Calif. Acad. Sci.*, 31(21): 563-600.
- Regan, C.T. 1913. The osteology and classification of the teleostean fishes of the order Scleroparei. *Ann. Mag. Nat. Hist.*, 8(11): 169-184.
- Rendahl, H. 1934. Zur Osteologie und Myologie des Schultergürtels und der Brustflosse einiger Scleroparei. *Arkiv. für Zoologi (Stochholm)*, 26(12): 1-50.
- Rutenberg, E.P. 1962. Survey of the fishes of family Hexagrammidae. pp. 1-103, in T.S. Rass, (ed.), *Greenings, taxonomy, biology, interoceanic transplantation*. (Transl. from Russian) Israel Program for Scientific Translations, Jerusalem, iv+208 pp.
- Rybachuk, V.K. 1976. Features of structure of the skeleton and caudal fin muscles in *Sebates*

- nebulosus* and *Sebastes jordani* (Sebastinae, Scorpaenidae). *J. Ichthyol.*, **16**(3): 452-458.
- Rybachuk, V.K. 1979. The skeleton and muscles of the dorsal fin of *Sebastes jordani* and *Sebastes nebulosus* (Scorpaenidae). *Ibid.*, **19**(4): 92-101.
- Sandercock, F.K. and N.J. Wilimovsky. 1968. Revision of the cottid genus *Enophrys*. *Copeia*, **1968**(4): 832-853.
- Sawada, Y. 1982. Phylogeny and zoogeography of the superfamily Cobitoidea (Cyprinoidei, Cypriniformes). *Mem. Fac. Fish. Hokkaido Univ.*, **28**(2): 65-223.
- Sideleva, V.G. 1982. *Seismosensory systems and ecology of the Baikalian sculpins (Cottoidei)*. Izv. (Nauka), Novosibirsk, 149 pp. (In Russian).
- Smith, C.L. and R.M. Bailey. 1961. Evolution of the dorsal fin supports of percoid fishes. *Mich. Acad.*, **46**: 345-362.
- Smith, C.L. and R.M. Bailey. 1962. The subocular shelf of fishes. *J. Morphol.*, **110**: 1-7.
- Sokal, R.R. 1983. A phylogenetic analysis of the Caminalcules. II. Estimating the true cladogram. *Syst. Zool.*, **32**(2): 185-201.
- Starks, E.C. 1901. Synonymy of the fish skeleton. *Proc. Wash. Acad. Sci.*, **3**: 507-539.
- Starks, E.C. 1930. The primary shoulder girdle of the bony fishes. *Stanford Univ. Publ., Univ. Ser., Biol. Sci.*, **6**(2): 149-239.
- Stein, D.L., 1978. A review of the deepwater Liparidea (Pisces) from the coast of Oregon and adjacent waters. *Occas. Pap. Calif. Acad. Sci.*, (127): 1-55.
- Stein, D.L. and C.E. Bond. 1978. A new deep-sea fish from the eastern North Pacific, *Psychrolutes phricтус* (Pisces: Cottidae (Psychrolutidae)). *Contrib. Sci. (Los Angeles)*, (296): 1-9.
- Stokely, P.S. 1952. The vertebral axis of two species of centrarchid fishes. *Copeia*, **1952**(4): 255-261.
- Takahasi, N. 1917. On the homology of the medial longitudinal muscles - supracarinalis and infracarinalis - with the fin muscles of the dorsal and anal fins and their functions. *J. Coll. Agri., Imp. Univ. Tokyo*, **6**(3): 199-213, pls. 1-2.
- Takahasi, N. 1925. On the homology of the cranial muscle of the cypriniform fishes. *J. Morphol. Physiol.*, **40**(1): 1-103, pls. 1-3.
- Taliev, D.N. 1955. *Sculpins of Baikal (Cottoidei)*. Akad. Nauk, SSSR, East Siberia Branch, Moscow, 603 pp. (In Russian).
- Taranetz, A.Y. 1941. On the classification and origin of the family Cottidae. *Isue. Kkad. Nauk. SSSR, Otd. Biol.* **1943**(3): 427-447. (Transk. from Russian) Inst. Fish., Univ. British Columbia Mus. Contr. 5: 1-28.
- Tominaga, Y. 1968. Internal morphology, mutual relationships and systematic position of the fishes belonging to the family Pempheridae. *Japan. J. Ichthyol.*, **15**(2): 43-95.
- Ueno, T. 1970. *Fauna Japonica: Cyclopteridae (Pisces)*. Academic Press of Japan, Tokyo, 233 pp., 13 pls.
- Vanden Berghe, L. 1928. Recherches sur la deglutition chez les poissons teleosteens. *Bull. Acad. R. Belg.*, **14**: 322-332.
- Vari, R.P. 1978. The terapon perches (Percoidei, Teraponidae). A cladistic analysis and taxonomic revision. *Bull. Amer. Mus. Nat. Hist.*, **159**(5): 175-340.
- Watanabe, M. 1958. *Studies on the sculpin of Japan and its adjacent waters*. Kadokawa Shoten, Tokyo, 416 pp., 123 pls. (In Japanese).
- Weitzmann, S.H. 1962. The osteology of *Brycon meeki*, a generalized fish, with an osteological definition of the family. *Stanford Ichthyol. Bull.*, **8**(1): 3-77.
- Wiley, E.O. 1976. The phylogeny and biogeography of fossil and recent gars (Actinopterygii: Lepisosteidae). *Univ. Kans. Mus. Nat. Hist. Misc. Publ.*, **64**: 1-111.
- Wiley, E.O. 1981. *Phylogenetics*. Wiley-Interscience Publication, New York, xv + 439 pp.
- Winterbottom, R. 1974a. A descriptive synonymy of the striated muscles of the teleostei. *Proc. Acad. Nat. Sci. Phila.*, **125**(12): 225-317.
- Winterbottom, R. 1974b. The familial phylogeny of the Tetraodontiformes (Acanthopterygii: Pisces) as evidenced by their comparative myology. *Smithson. Contrib. Zool.*, (155): i-iii + 1-201.
- Yabe, M. 1981. Osteological review of the family Icelidae Berg, 1940 (Pisces; Scorpaeniformes),

with comment on the validity of this family. *Bull. Fac. Fish. Hokkaido Univ.*, **32**(4) : 293-315.

Yabe, M. 1983. A new cottoid fish of the family Ereuniidae, *Marukawichthys pacificus*, from the central North Pacific. *Japan. J. Ichthyol.*, **30**(1) : 18-26.