



Title	TAXONOMY AND PHYLOGENY OF THE FAMILY AGONIDAE (PISCES: SCORPAENIFORMES)
Author(s)	KANAYAMA, Tsutomu
Citation	MEMOIRS OF THE FACULTY OF FISHERIES HOKKAIDO UNIVERSITY, 38(1-2), 1-199
Issue Date	1991-12
Doc URL	http://hdl.handle.net/2115/21888
Type	bulletin (article)
File Information	38(1_2)_P1-199.pdf



[Instructions for use](#)

TAXONOMY AND PHYLOGENY OF THE FAMILY AGONIDAE
(PISCES : SCORPAENIFORMES)*

By

Tsutomu KANAYAMA

*Laboratory of Marine Zoology, Faculty of Fisheries,
Hokkaido University*

Contents

	Page
I. Introduction	3
II. Materials and methods	4
III. Acknowledgments	9
IV. Taxonomy of the family Agonidae	10
1. Subfamily Percidinae	12
Genus <i>Hypsagonus</i>	12
<i>Hypsagonus mozinoi</i>	15
<i>Hypsagonus quadricornis</i>	17
<i>Hypsagonus corniger</i>	19
<i>Hypsagonus proboscidalis</i>	21
<i>Hypsagonus jordani</i>	23
Genus <i>Percis</i>	26
<i>Percis japonicus</i>	27
<i>Percis matsuii</i>	29
2. Subfamily Agoninae	31
Genus <i>Freemanichthys</i> gen. nov.	32
<i>Freemanichthys thompsoni</i>	34
Genus <i>Leptagonus</i>	36
<i>Leptagonus decagonus</i>	37
<i>Leptagonus frenatus</i>	39
<i>Leptagonus leptorhynchus</i>	42
Genus <i>Podothecus</i>	45
<i>Podothecus acipenserinus</i>	46
<i>Podothecus veterinus</i>	49
<i>Podothecus hamlini</i>	51
<i>Podothecus sturioides</i>	53
<i>Podothecus sachi</i>	57
Genus <i>Agonus</i>	60
<i>Agonus cataphractus</i>	61
Genus <i>Agonopsis</i>	62
<i>Agonopsis vulsa</i>	63
<i>Agonopsis sterletus</i>	65

* The present work was submitted as a partial fulfillment of the requirements for Doctor's degree in Fisheries Science at Hokkaido University in 1990.

	<i>Agonopsis chiloensis</i>	66
3.	Subfamily <i>Anoplagoninae</i>	68
	Genus <i>Bothragonus</i>	68
	<i>Bothragonus swani</i>	69
	<i>Bothragonus occidentalis</i>	71
	Genus <i>Bathyagonus</i>	72
	<i>Bathyagonus nigripinnis</i>	73
	<i>Bathyagonus pentacanthus</i>	74
	<i>Bathyagonus alascamus</i>	76
	<i>Bathyagonus infraspinatus</i>	77
	Genus <i>Xenertmus</i>	78
	<i>Xenertmus triacanthus</i>	79
	<i>Xenertmus latifrons</i>	80
	<i>Xenertmus leiops</i>	82
	<i>Xenertmus ritteri</i>	83
	Genus <i>Odontopyxis</i>	84
	<i>Odontopyxis trispinosa</i>	84
	Genus <i>Ulcina</i>	86
	<i>Ulcina olriki</i>	86
	Genus <i>Aspidophoroides</i>	88
	<i>Aspidophoroides monopterygius</i>	88
	Genus <i>Anoplagonus</i>	91
	<i>Anoplagonus inermis</i>	92
	<i>Anoplagonus occidentalis</i>	93
4.	Subfamily <i>Brachyopsinae</i>	94
	Genus <i>Stellerina</i>	95
	<i>Stellerina xyosterna</i>	95
	Genus <i>Chesnonia</i>	97
	<i>Chesnonia verrucosa</i>	97
	Genus <i>Ocella</i>	99
	<i>Ocella dodecaedron</i>	100
	<i>Ocella iburia</i>	103
	<i>Ocella kuronumai</i>	104
	<i>Ocella kasawai</i>	106
	<i>Ocella impi</i>	108
	Genus <i>Tilesina</i>	109
	<i>Tilesina gibbosa</i>	109
	Genus <i>Brachyopsis</i>	111
	<i>Brachyopsis segaliensis</i>	112
	Genus <i>Pallasina</i>	113
	<i>Pallasina barbata</i>	114
V.	Systematic methodology	117
	1. Application of cladistics	117
	2. Procedures	117
VI.	Comparative morphology	120
	1. Circumorbital bones	120
	2. Jaws	126
	3. Suspensorium and opercular apparatus	131
	4. Hyoid apparatus	136
	5. Branchial apparatus	141
	6. Cranium	144
	7. Pectoral girdle	156

8. Pelvic girdle	160
9. Vertebrae and pterygiophores	162
10. Caudal skeleton	169
VII. Phylogenetic classification of the family Agonidae	173
1. Monophyly of the family Agonidae	173
2. Characters and conditions	175
3. Interrelationships of the agonid genera and species	176
4. General consideration	185
VIII. Summary	191
IX. Literature cited	193

I. Introduction

The fishes of the family Agonidae, mainly inhabiting the sandy and rocky bottoms of shallow waters, are distributed in the northern North Pacific Ocean. A few species only are known from the Arctic Sea, the northern North Atlantic, the North Sea, and waters off the Patagonian Region of the Southern Hemisphere. In this group, belonging to the superfamily Cottoidea, order Scorpaeniformes, there were 54 nominal species recognized up to now.

Taxonomic studies of agonid fishes have been undertaken by various ichthyologists, based on specimens from limited regions, since Linnaeus (1758) first described *Cottus cataphractus* (= *Agonus cataphractus*), from the northern North Atlantic. Resulting from collections made in the course of various scientific expeditions, and the work of authors including Pallas (1769), Scopoli (1777), Lacépède (1801), Cuvier (1829), Günther (1860), Cramer (1894) and Gilbert (1896), the number of agonid species known in the nineteenth century accumulated gradually. Jordan and Evermann (1898) established the foundation of agonid classification, but were primarily concerned with American species. Since Jordan and Evermann (1898), American species of agonids have been studied regionally by Gilbert (1904), Kincaid (1919), Wilimovsky (1954), Fitch (1966, 1973), Gruchy (1969, 1970), Wilimovsky and Wilson (1978), Leipertz (1985), and others. In the seas of the Far East, agonid species were investigated by Jordan and Starks (1904), Schmidt (1904), Soldatov and Lindberg (1930), Taranetz (1933, 1937), Lindberg (1935, 1947, 1950, 1959, 1971), Matsubara (1936, 1955), Andriashev (1937), Ueno (1967), Kanayama (1980, 1983, 1984), Lindberg and Krasnyukova (1987), and others. Thus, agonid studies at the specific level have been both regional and fragmentary.

Concerning the higher ranking of agonids, Gill (1862d) first divided the group, proposing two subfamilies, Agoninae and Anoplagoninae, but based such on little information. Gill's classification was followed by Nelson (1976, 1984) Jordan and Evermann (1898) reviewed the family, and recognized four subfamilies, Percidinae, Brachyopsinae, Agoninae and Aspidophoroidinae, but again on the basis of a very few specimens of each species. Although unpublished, the Stanford University doctoral dissertation by Freeman (1951a) described many species in the family Agonidae, but based on few specimens. In Freeman's work, the agonid fishes were classified into four subfamilies, Percidinae, Brachyopsinae, Agoninae and Xenertminae. This classification was followed by Leipertz (1988). In a regional study on

Japanese fishes, Matsubara (1955) divided the group into two families, Agonidae and Aspidophoridae, with four subfamilies, Tilesininae, Percinae (=Percidinae), Brachyopsinae and Agoninae, in the Agonidae. Despite lacking a detailed comparison of agonid fishes, Lindberg (1971) recognized six subfamilies, Aspidophoroidinae, Percidinae, Brachyopsinae, Agoninae, Bathyagoninae and Bothragoninae. Thus, the taxonomy of the agonid fishes is fragmentary and confused.

Osteological studies of agonids have been made in a piecemeal fashion by a limited number of workers. Starks (1926, 1930) described the ethmoidal region and pectoral girdle of the genus *Podothecus*. Rendahl (1934) reported on the cranial osteology of *Hypsagonus quadricornis*, and Ilina (1978) showed cranial aspects of the genera *Podothecus* and *Agonus*. Leipertz (1985, 1988) described osteological aspects of some agonid species, mostly belonging to *Xenertmus* and *Bothragonus*, based on a few specimens.

The phylogeny of agonid fishes has been poorly studied. Regan (1913) proposed that the family Agonidae was close to the family Cottidae, based on the comparative osteology of a few agonid fishes and other scorpaeniform species. Schmidt (1936) discussed interrelationships of the genus *Agonus*, on the basis of snout barbels. Freeman (1951a) and Nishimura (1974), used external characters only, to propose an agonid phylogeny. These studies, carried out on the basis of external and a few internal characters, are not now considered satisfactory. Recently, in his phylogenetic classification of cottoid fishes, Yabe (1985) designated the monophyly of the agonids, and considered the family Agonidae to be a sister group of the Hemitripterae, on the basis of the analysis of a few agonid species. Concurrently, Leipertz (1985) discussed the phyletic relationships of the subfamily Xenertminae (=Anoplagoninae of Gill, 1862d) based on a cladistic analysis of external characters. In his study of the relationships of *Bothragonus*, Leipertz (1988) proposed four subfamilies in the Agonidae, on the basis of external and some internal characters of 10 species. Accordingly, except for the subfamily Xenertminae, studied by Leipertz (1988), studies of the interrelationships of agonid fishes are fragmentary and unsatisfactory.

Under such circumstances, it was necessary to review the agonids on a world-wide basis and to clarify the relationships within the family on the basis of both internal, viz., circumorbital bones, jaws, suspensorium, opercular apparatus, hyoid apparatus, branchial apparatus, cranium, pectoral and pelvic girdles, vertebrae and pterygiophores, and caudal skeleton, and external characters.

In the present study, all of the known agonid species were classified into supraspecific taxa, which were defined on the basis of cladistic analysis.

II. Materials and methods

The specimens used for the present study are preserved in the following depositories (abbreviations are listed in Leviton et al. (1985), except for IFES (Iwate Fisheries Experimental Station, Kamaishi)): AMS, BCPM, BMNH, BSKU, CAS, CAS-SU, FAKU, FRSKU, FSFL, HUMZ, KSHS, LACM, NMC, NSMT, UBC, UCLA, USNM, ZUMT.

For comparative anatomical studies, the dissected specimens were as follows.

Agonidae

- Hypsagonus mozinoi*, one specimen, 40.2 mm SL, UCLA 63-256.
H. quadricornis, one specimen, 68.0 mm SL, HUMZ 56026.
H. corniger, one specimen, 79.0 mm SL, HUMZ 92905 (radiograph only).
H. proboscidalis, one specimen, 117.3 mm SL, HUMZ 55535.
H. jordani, one specimen, 122.8 mm SL, HUMZ 45887.
Percis japonicus, 4 specimens, 176.0-264.0 mm SL, HUMZ 51539, 52736, 52749 and un-catalogued specimen.
P. matsuii, one specimen, 125.4 mm SL, BSKU 13450.
Freemanichthys thompsoni, 3 specimens, 112.0-139.7 mm SL, HUMZ 52845, 68386, 76649.
Leptagonus decagonus, one specimen, 144.6 mm SL, HUMZ 56291.
L. frenatus, 3 specimens, 195.8-211.0 mm SL, HUMZ 51516, 52747, 56372.
L. leptorhynchus, 4 specimens, 156.0-167.0 mm SL, HUMZ 45813, 68253, 76649, 77244.
Podothecus acipenserinus, 6 specimens, 174.5-229.0 mm SL, HUMZ 76797, 76881, 76894, 76991, 77302-77303.
P. vetermus, 6 specimens, 151.1-162.0 mm SL, HUMZ 58918-58919, 58924-58925, 58949, 58957.
P. hamlini, one specimen, 90.5 mm SL, HUMZ 86873.
P. sturioides, 3 specimens, 187.2-232.0 mm SL, HUMZ 45740, 81240-81241.
P. sachi, 3 specimens, 271.0-386.0 mm SL, HUMZ 90442 and two uncatalogued specimens.
Agonus cataphractus, one specimen, 113.4 mm SL, HUMZ 64428.
Agonopsis vulsa, one specimen, 106.9 mm SL, HUMZ 17448.
A. sterletus, 2 specimens, 108.7-119.0 mm SL, LACM 2082-2.
A. chiloensis, one specimen, 105.0 mm SL, BMNH 1132-1142.
Bothragonus swani, one specimen, 49.4 mm SL, HUMZ 51922.
B. occidentalis, one specimen, 35.6 mm SL, HUMZ 77436.
Bathyagonus nigripinnis, 3 specimens, 140.7-187.0 mm SL, HUMZ 17462, 44900, 83754.
B. pentacanthus, 3 specimens, 162.0-182.0 mm SL, HUMZ 40420-40422.
B. alascanus, one specimen, 99.7 mm SL, HUMZ 17450.
B. infraspinnatus, one specimen, 83.9 mm SL, HUMZ 17473.
Xenertmus latifrons, 2 specimens, 108.8-129.0 mm SL, HUMZ 51924, 52025.
X. leiops, one specimen, 213.2 mm SL, HUMZ 51925.
X. triacanthus, one specimen, 146.5 mm SL, CAS 14276(18).
Odontopyxis trispinosa, 2 specimens, 60.0-62.0 mm SL, BCPM 978-144, HUMZ 62266.
Ulcina olriki, one specimen, 56.5 mm SL, HUMZ 69036.
Aspidophoroides monopterygius, 3 specimens, 109.0-140.0 mm SL, HUMZ 22272, 81038-81039.
Anoplagonus inermis, one specimen, 86.0 mm SL, BCPM 978-102.
A. occidentalis, one specimen, 75.5 mm SL, HUMZ 74845.
Stellerina xyosterna, one specimen, 95.0 mm SL, LACM 30953-2.
Chesnomia verrucosa, 2 specimens, 103.2-108.3 mm SL, LACM 31982-5.
Ocella dodecaedron, one specimen, 142.7 mm SL, HUMZ 76887.
O. iburia, 3 specimens, 93.3-195.0 mm SL, HUMZ 49565, 71287, 71302.
O. kuronumaï, 4 specimens, 153.0-186.8 mm SL, HUMZ 64788, 64791, 64794, 64798.
O. kasawai, 3 specimens, 232.8-268.7 mm SL, HUMZ 5541, 47520, 88098.
Tilesina gibbosa, 3 specimens, 216.0-255.5 mm SL, HUMZ 45901 and two uncatalogued specimens.
Brachyopsis segaliensis, 3 specimens, 140.5-214.1 mm SL, HUMZ 90441 and 2 uncatalogued specimens.
Pallasina barbata, 4 specimens, 73.8-148.6 mm SL, HUMZ 51945, 53539, 62502, 88097.

Other scorpaeniform fishes

Scorpaenidae

- Sebastes matsubarae*, one specimen, 114 mm SL, HUMZ 90303.
S. schlegeli, one specimen, 150 mm SL, HUMZ 86834
S. hubbsi, one specimen, 149 mm SL, HUMZ 78491.
S. alutus, one specimen, 309 mm SL, HUMZ 81364.
S. oculatus, 2 specimens, 232–272 mm SL, HUMZ 82213, 82271.
S. semicinctus, 2 specimens, 271–288 mm SL, HUMZ 81125, 81126.
Sebastiscus marmoratus, one specimen, 183 mm SL, HUMZ 39653.
Helicolenus papillosus, 2 specimens, 165–188 mm SL, HUMZ 21046, 91501.
H. hilgendorfi, 11 specimens, 85–146 mm SL, HUMZ 35331, 35346, 35348, 36604, 39687, 49917, 52279, 52281, 62645, 62644, 79512.
H. dactylopterus, 5 specimens, 192–267 mm SL, HUMZ 74475, 74478, 74482, 74485, 74489.
Hozukius embremarius, one specimen, 151 mm SL, HUMZ 72629.
H. guyotensis, one specimen, 232 mm SL, HUMZ 71936.
Scorpaenodes littoralis, 2 specimens, 46–82 mm SL, NSMT-P 18631.
S. guamensis, 2 specimens, 69–71 mm SL, HUMZ 39751, 79818.
Hoplosebastes armatus, one specimen, 69 mm SL, HUMZ 37270.
Scorpaena neglecta, 2 specimens, 93–147 mm SL, HUMZ 64768, 79961.
S. agassizii, one specimen, 89 mm SL, HUMZ 31310.
S. scrofa, one specimen, 93 mm SL, HUMZ 72460 (radiograph only).
Scorpaenopsis cirrhosa, one specimen, 95 mm SL, HUMZ 47141.
Neosebastes entaxis, 2 specimens, 118–119 mm SL, BSKU 599, 8875.
N. nigropunctatus, one specimen, 171 mm SL, HUMZ 21097 (radiograph only).
N. panticus, one specimen, 195 mm SL, HUMZ 21060 (radiograph only).
Pterois lunulata, 5 specimens, 90–151 mm SL, HUMZ 36573, 37801, 37827, 38473, 70360 (radiograph only).
Brachypterois serrulatus, 3 specimens, 80–82 mm SL, HUMZ 35083, 36733, 80680.
Ebosia bleekeri, 3 specimens, 96–109 mm SL, BSKU 196, 200, 287 (radiograph only).
E. falcata, one specimen, 70 mm SL, HUMZ 73842.
Parapterois heterurus, one specimen, 89 mm SL, HUMZ 37377.
Dendrochirus bellus, one specimen, 87 mm SL, HUMZ 80711, and one uncatalogued specimen from Taiwan.
D. zebra, 3 specimens, 120–134 mm SL, HUMZ 39630, 48699, 62987.
Rhinopias frondosa, one specimen, 151 mm SL, KSHS 15645.
Apistus carinatus, one specimen, 98 mm SL, HUMZ 49029.
Sebastolobus macrochir, one specimen, 169 mm SL, HUMZ 68329.
Adelosebastes latens, one specimen, 206 mm SL, HUMZ 72035.
Plectrogenium nanum, one specimen, 36 mm SL, HUMZ 79902.
Setarches fidjiensis, one specimen, 103 mm SL, HUMZ 75395.
Ectreposebastes imus, one specimen, 128 mm SL, HUMZ 32006.
Hypodytes rubripinnis, one specimen, 50 mm SL, HUMZ 51921.
Neocentropogon aeglefinus japonicus, one specimen, 83 mm SL, HUMZ 74799.
Ocosia vespa, one specimen, 71 mm SL, HUMZ 74791.
Minous monodactylus, one specimen, 83 mm SL, HUMZ 70842.
M. pusillus, one specimen, 60 mm SL, HUMZ 37224.
M. longimanus, one specimen, 79 mm SL, HUMZ 74157.
Inimicus japonicus, one specimen, 195 mm SL, HUMZ 49018.
Erosa erosa, one specimen, 126 mm SL, HUMZ 74750.

Caracanthidae

Caracanthus maculatus, one specimen, 26 mm SL, 2 uncatalogued specimens from Raboul, Nordup, New British Is.

Aploactinidae

Aploactis aspera, one specimen, 59 mm SL, HUMZ 74797.

Erisphex potti, 2 specimens, 61-70 mm SL, HUMZ 71264, 71267.

Gnathanacanthidae

Gnathanacanthus goetzi, one specimen, 181 mm SL, AMS I 6850.

Congiopodidae

Congiopodus pervianus, one specimen, 292 mm SL, HUMZ 72302.

C. coriaceus, one specimen, 184 mm SL, HUMZ 91191.

Alertichthys blacki, one specimen, 175 mm SL, HUMZ 66622.

Triglidae

Lepidotrigla microptera, one specimen, 103 mm SL, HUMZ 45296.

Satyrichthys amiscus, one specimen, 106 mm SL, HUMZ 49910.

Peristedion nierstraszi, one specimen, 143 mm SL, HUMZ 49909.

Bembridae

Parabembras curta, one specimen, 94 mm SL, HUMZ 71651.

Bembras japonicus, one specimen, 123 mm SL, HUMZ 79118.

Bembradium roseum, one specimen, 86 mm SL, HUMZ 79188.

Hoplichthyidae

Hoplichthys gilberti, one specimen, 148 mm SL, HUMZ 74850.

Anoplopomatidae

Erileps zonifer, one specimen, 126 mm SL, HUMZ 87865.

Anoplapoma fimbria, one specimen, 276 mm SL, HUMZ 67473.

Hexagrammidae

Hexagrammos lagocephalus, one specimen, 152 mm SL, HUMZ 75854.

H. octogrammus, one specimen, 173 mm SL, one uncatalogued specimen from Usujiri, Hokkaido, Japan.

Pleurogrammus azonus, one specimen, 276 mm SL, one uncatalogued specimen from Usujiri, Hokkaido, Japan.

Hemitripteridae

Hemitripterus bolini, one specimen, 174 mm SL, HUMZ 77038.

Blepsias cirrhosus, one specimen, 135 mm SL, HUMZ 92271.

Nautichthys oculofasciatus, one specimen, 72 mm SL, HUMZ 69126.

Cottidae

Hemilepidotus gilberti, one specimen, 242 mm SL, HUMZ 45786.

Icelus cataphractus, one specimen, 62 mm SL, one uncatalogued specimen from Kushiro, Hokkaido, Japan.

Cyclopteridae

Aptocyclus ventricosus, one specimen, 156 mm SL, HUMZ 68572.

Eumicrotremus soldatovi, one specimen, 158 mm SL, HUMZ 60344.

E. birulai, one specimen, 72 mm SL, HUMZ 67709.

Liparididae

Liparis tessellatus, one specimen, 107 mm SL, one uncatalogued specimen from Kushiro, Hokkaido, Japan.

Catalogue number and size of agonid specimens observed by radiograph are given in the section on taxonomy.

Measurements were straight-line distances made with dial calipers and recorded to the nearest tenth of a millimeter.

They were defined as follows.

Standard length (SL): tip of snout to posterior end of hypural plate. If a forwardly projecting nasal spine was present, tip of spine to posterior end of hypural was measured.

Head length (HL): tip of snout (or tip of upper jaw) to posterior end of opercular membrane.

Snout length: tip of snout (or tip of upper jaw) to anterior margin of orbit.

Orbit diameter: anterior margin to posterior margin of orbit.

Interorbital width: shortest distance between orbits. In *Hypsagonus* and *Percis*, the widest distance between supraocular crests.

Body depth: vertical distance from pelvic fin base to top of body.

Body width: distance between pectoral fin bases.

Predorsal length: tip of snout to dorsal fin origin.

Pectoral fin length: base of pectoral fin to posterior tip of longest ray.

Pelvic fin length: base of pelvic spine to posterior tip of ray.

Interdorsal width: posterior end of first dorsal fin membrane to origin of second dorsal fin.

Depth of caudal peduncle: shortest vertical height of caudal peduncle including spine.

Width of caudal peduncle: least width of caudal peduncle, including spine.

Caudal fin length: end of hypural to posterior tip of caudal fin ray.

Depth of dorsal fin: length of first dorsal fin ray. In *Ulcina*, *Aspidophoroides* and *Anoplagonus*, length of second dorsal fin ray.

Depth of anal fin: length of longest ray.

Pelvic-anal length: base of pelvic fin spine to anal fin origin.

Pelvic-anus length: base of pelvic fin spine to center of anus.

Counts were taken from the following.

Dorsal (D), anal (A), pectoral (P1) and pelvic (P2) fins, including all rays and spines.

Caudal fin (C): upper and lower rays on hypural plate.

Branchiostegal rays (Br): total number of rays.

Snout barbels: total number on anterior tip of snout.

Ventral snout barbels: total number on ventral surface of snout. Counted on left side only when a pair of patches were present. When three patches of barbels were present, each patch was counted.

Maxillary barbels: total number of barbels on posterior half of maxillary.

Terminology of bony plates essentially followed Gruchy (1969), Kanayama (1984), and Leipertz (1985). Elements were defined as follows (Fig. 1).

Middorsal row of plates (MDR): a single row of middorsal plates behind posterior end of second dorsal fin.

Plates of dorsolateral row (DLR): a pair of rows of plates just behind head, along dorsal fin base, to origin of middorsal plates.

Plates of supralateral row (SLR): a pair of rows of plates between lateral line plates and dorsolateral plates, counting end of hypural plate.

Plates of lateral line (LLR): tubular plates, just behind posttemporal to caudal fin base.

Plates of infralateral row (ILR): paired plates between lateral line plates and

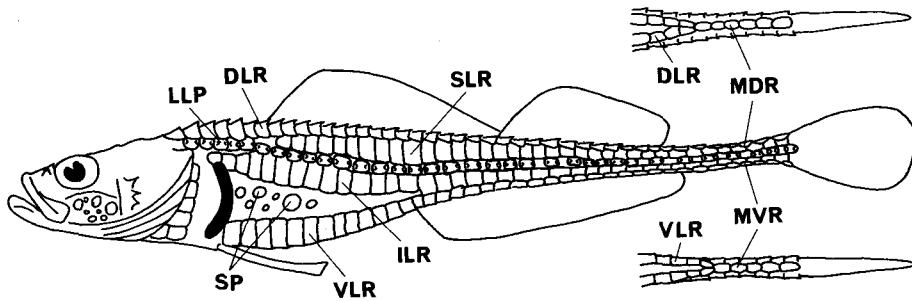

Fig. 1. Bony plates of agonid fishes: DLR, dorsolateral plates; ILR, infralateral plates; LLP, lateral line plates; MDR, middorsal plates; MVR, midventral plates; SLR, supralateral plates; SP, subpectoral plates; VLR, ventrolateral plates.

ventrolateral plates, from just behind pectoral fin base to end of hypural plate. Plates of ventrolateral row (VLR): paired plates below infralateral plates, from pelvic fin base, along anal fin base, to origin of midventral plates.

Plates of midventral row (MVR): a single row of plates on midventral portion of caudal peduncle.

Subpectoral plates (SP): plates behind pectoral fin base, between lateral line plates and infralateral plates, or infralateral plates and ventrolateral plates.

Infraorbital plates: plates on cheek, between infraorbital bones and preopercular ridge.

Predorsal plates (PP): paired plates just behind head to dorsal fin origin.

Vertebral counts were made from radiographs, and are shown as total counts.

The specimens used for comparative anatomical studies were dissected after being stained with alizarin red-S, and examined with a binocular microscope. For osteological observations, several specimens were cleared and stained. Osteological drawings were made with a wild M-S drawing tube. Terminology used here chiefly follows most modern ichthyologists (e.g. Monod, 1967; Nelson, 1969; Liem, 1970; Yabe, 1985).

III. Acknowledgments

I wish to express my sincere gratitude to Professor Kunio Amaoka, Hokkaido University, for his guidance in the course of this study and critical reading of the manuscript. I am also grateful to Professor Takashi Minoda and Associate Professor Kazuhiro Nakaya, Hokkaido University, for their critical reading of the manuscript, and to the late Professor Takao Igarashi, Hokkaido University, for his guidance in the course of the study.

For their help during this study I wish to thank the following: Messrs. Koji Abe, Mikio Koike, Umeji Suzuki, Toshihiro Mizushima, Shuka Maruyama, and the late Dr. Tatsuji Ueno, all of Hokkaido Fisheries Experimental Station; Drs. Ryoi-chi Arai, Keiichi Matsuura, National Science Museum, Tokyo; Dr. Donald G. Buth, University of California; Dr. Lo-chai Chen, San Diego State University; Drs.

William N. Eschmeyer, Tomio Iwamoto, California Academy of Sciences ; Dr. Harry W. Freeman, College of Charleston ; Dr. Hiroshi Hatanaka, Mr. Takashi Sasaki, Far Seas Fisheries Research Laboratory ; Drs. Tamotsu Iwai, Izumi Nakamura, Tetsuji Nakabo, Kyoto University ; Ms. Susan L. Jewett, U.S. National Museum ; Mr. Shini-chi Kanamaru, Japan Sea Regional Fisheries Research Laboratory ; Mr. Yasuo Kano, Uozu Aquarium ; Dr. Daiji Kitagawa, Tohoku Regional Fisheries Research Laboratory ; Mr. Hisaharu Yoshida, Hokkaido Regional Fisheries Research Laboratory ; Dr. Robert J. Lavenberg, Los Angeles County Museum ; Dr. Don E. McAllister, Canadian Museum of Nature ; Dr. Osamu Okamura, Kochi University ; Dr. Muneo Okiyama, Ocean Research Institute, University of Tokyo ; Dr. John R. Paxton, Australian Museum ; Dr. Alex E. Peden, British Columbia Provincial Museum ; Dr. Yoshiaki Tominaga, University of Tokyo ; Mr. Alwyne Wheeler, British Museum (Natural History) ; Dr. Norman J. Wilimovsky, University of British Columbia ; Mr. Takeshi Yamakawa, Kochi High School ; Dr. Toru Yasuda, Fukui Prefectural Fisheries Experimental Station.

Finally, my special thanks go to Dr. Mamoru Yabe and the graduate students of the Laboratory of Marine Zoology, Hokkaido University, for giving valuable advice and accomodation. Dr. Graham S. Hardy, Minoo City, Osaka, provided critical reading of the manuscript.

This work was supported in part by grants from the Ito Foundation for the Advancement of Ichthyology.

IV. Taxonomy of the family Agonidae

Family Agonidae Swainson, 1839

Agonidae Swainson, 1839, p. 272.

Aspidophoroididae, Jordan, Evermann and Clark, 1930, p. 397.

External diagnosis. Agonidae are distinguished from other families of the order Scorpaeniformes in having the following characters: body covered with bony plates; thoracic pelvic fin with one spine and two rays; all fin rays unbranched; one or two dorsal fins; 10-12 principal caudal rays; five or six branchiostegal rays.

Internal diagnosis. Agonidae differ from other families of the order Scorpaeniformes in possessing the following characters: basihyal rudimentary or absent; no suspensory pharyngeal; one upper pharyngeal; no tooth plate on third epibranchial; circumorbital bones with a lachrymal and three infraorbital bones; second infraorbital bone attached widely to preopercular ridge; epipleural and pleural ribs attached to parapophysis; no stay; Baudelot's ligament attached to first centrum; no predorsal bone; one or two epurals; all hypurals fused with each other and with the first preural centrum, plate-like; three or four actinosts on pectoral girdle, plate-like, attached to each other; swimbladder absent.

Remarks. The family Agonidae contains four subfamilies, 20 genera, and 45 species.

Key to the genera of the family Agonidae

- 1a. Two dorsal fins. Plates of supralateral row present. 2.

- 1b. One dorsal fin (first dorsal fin absent). Plates of supralateral row absent. 13.
- 2a. Posterior nasal tube short, never reaching upper jaw. 3.
- 2b. Posterior nasal tube long, reaching upper jaw. *Percis*
- 3a. A barbel present (rarely absent) on snout tip. Predorsal region highly elevated. *Hypsagonus*
- 3b. No barbel on snout tip. Predorsal region never highly elevated. 4.
- 4a. Gill membrane joined to isthmus. Nasal bones attached to each other anteriorly. Mouth terminal or inferior: jaws about equal or lower jaw included in upper one or (rarely) lower jaw projecting forward beyond upper jaw. 5.
- 4b. Gill membrane free from isthmus. Nasal bones never attached to each other anteriorly. Mouth terminal: lower jaw projecting forward beyond upper jaw. 15.
- 5a. Two or three patches of barbels on ventral surface of snout. 6.
- 5b. Patches of barbels usually absent from ventral surface of snout; when present, one or two pairs of barbels. 7.
- 6a. Single ethmoidal spine on mid-snout. Rostral plate present on ventral surface of snout, with a spine. Maxillary barbels 25 or more. Nasal bone with a serrated margin, without a forwardly projecting spine. *Freemanichthys* gen. nov.
- 6b. A pair of ethmoidal spines on mid-snout. Rostral plate absent from ventral surface of snout. Maxillary barbels 20 or less. Nasal bone with a forwardly projecting spine. *Podothecus*
- 7a. No cirri nor barbels on gill membranes or gular region. 8.
- 7b. Numerous cirri or barbels on gill membranes and gular region. 9.
- 8a. No enlarged rostral plate on snout tip. Nasal bone projecting forward beyond upper jaw. *Leptagonus*
- 8b. Enlarged rostral plate on snout tip. Nasal bone never projecting forward beyond upper jaw. 10.
- 9a. No spine on supraocular and parietal. *Agonus*
- 9b. A spine on supraocular and parietal. *Agonopsis*
- 10a. Rostral plate without spine. *Bothragonus*
- 10b. Rostral plate with one or three upturned spines. 11.
- 11a. Rostral plate with one upturned spine. 12.
- 11b. Rostral plate with three upturned spines. *Bathyagonus*
- 12a. Occipital pit absent. A spine on second infraorbital. *Xenertmus*
- 12b. A pair of deep occipital pits, just behind head. No spine on second infraorbital. *Odontopyxis*
- 13a. A barbel present on end of maxillary. Predorsal plates 17 or less. .. *Ulcina*
- 13b. No barbel on end of maxillary. Predorsal plates 18 or more. 14.
- 14a. Nasal spine recurved posterodorsally. *Aspidophoroides*
- 14b. Nasal spine absent. *Anoplagonus*
- 15a. Dorsal fin spines 15 or less. Anal fin rays 20 or less 16.
- 15b. Dorsal fin spines 17 or more. Anal fin rays 23 or more. *Tilesina*
- 16a. Maxillary barbel present. 17.

- 16b. Maxillary barbel absent.19.
 17a. Enlarged plates on breast. Maxillary barbel short, 2.5 or more in orbit diameter. Prevomerine teeth present.18.
 17b. No enlarged bony plates on breast. Maxillary barbel long, 2.0 or less in orbit diameter. Prevomerine teeth absent.*Stellerina*
 18a. Ventrolateral plates 28 or less. Lateral line plates 39 or less. Anal fin rays 13 or less.*Chesnonia*
 18b. Ventrolateral plates 30 or more. Lateral line plates 39 or more. Anal fin rays 13 or more.*Occella*
 19a. Barbel absent from lower jaw tip. Pectoral fin rays 14 or more. Predorsal plates 11 or less.*Brachyopsis*
 19b. Barbel present on lower jaw tip. Pectoral fin rays 13 or less. Predorsal plates 12 or more.*Pallasina*

1. Subfamily Percidinae Jordan et Evermann, 1898

Percidinae Jordan and Evermann, 1898, p. 2032.

Percinae. Matsubara, 1955, p. 1162.

External diagnosis. Percidinae are distinguished from other subfamilies of the family Agonidae in having the following characters: no enlarged rostral plate on snout tip; gill membranes free from isthmus; terminal mouth, about equal jaws; predorsal region usually highly elevated.

Internal diagnosis. Percidinae differ from other subfamilies of Agonidae in possessing the following osteological characters: no attachment between lachrymal and nasal; attachment between entopterygoid and metapterygoid; no rostral plate; smooth anterior free nasal margin; no forward projection of nasal; no attachment between prevomer and ethmoid; small anterior process of ethmoid; convex dorsal margin of orbit; four actinosts; presence of pores between actinosts on pectoral girdle; one tabular bone; no inner pelvic keel; anterior insertion of dorsal pterygiophores; two spines on first dorsal pterygiophore; discontinuous spinous dorsal pterygiophores; two epurals.

Remarks. The subfamily Percidinae contains two genera, *Hypsagonus* and *Percis*.

Genus *Hypsagonus* Gill, 1862

Hypsagonus Gill, 1862c, p. 167 (type, *Aspidophorus quadricornis* Cuvier).

Cheiragonus Herzenstein, 1890, p. 116 (type, *Hypsagonus gradiens* Herzenstein = *Aspidophorus quadricornis* Cuvier).

Agonomalus Guichenot, 1866, p. 254 (type, *Aspidophorus proboscidalis* Valenciennes).

External diagnosis. *Hypsagonus* is distinguished from other genera of the family Agonidae in having the following characters: two dorsal fins; short posterior nasal tube, never reaching upper jaw; nasal bones attached to each other or not; no rostral plate; nasal bone never beyond upper jaw; a nasal spine recurved posterodorsally; no ethmoidal spine; a long parietal spine with a supplementary blunt knob at its anterior base; absence of ventral snout barbel; maxillary without flap; no barbel on lower jaw tip; gill membrane united, free from isthmus; six branchiostegal rays; no occipital pit; 7-11 dorsal fin rays; 10-14 anal fin rays; 1-

4 predorsal plates; presence of supralateral plates; breast covered with prickles or small plates.

Internal diagnosis. *Hypsagonus* differs from other genera of Agonidae in possessing the following osteological characters: lachrymal without median shelf; ascending process of premaxillary longer than alveolar process; interhyal longer than epihyal; plate-like urohyal; no basihyal; three basibranchials; exoccipital never exposed; one tabular bone; four actinosts on pectoral girdle; two postcleithra; absence of postpelvic spine; presence of pleural rib; first dorsal proximal radial inserted into first space between first and second neural spines, supporting two spines; interneural spaces between well separated two dorsal fins, with an interdorsal spine; two epurals.

Remarks. Gill (1862c) proposed a new genus, *Hypsagonus*, for *Aspidophorus quadricornis* Cuvier. Without referring to Gill (1862c), Guichenot (1866) later established *Agonomalus* based on *Aspidophorus proboscidalis* Valenciennes. *Agonomalus* consists of three species, *A. proboscidalis*, *A. jordani* and *A. mozinoi*, and *Hypsagonus* of *H. quadricornis* and *H. corniger*. However, these five species do not show any clear cut differences to justify separation of *Agonomalus* from



Fig. 2. Pectoral fin of *Hypsagonus jordani* (top), *H. proboscidalis* (middle) and *H. quadricornis* (bottom).

Table 1. Comparison of species of the genus *Hypsagonus*.

	<i>mozinoi</i>	<i>quadricornis</i>	<i>corniger</i>	<i>proboscidalis</i>	<i>jordani</i>
Anal fin rays	10-12	10-11	11	11-13	13-14
Pectoral fin rays	11-12	12-14	12	10-11	10-11
Lateral line plates	18-20	6-11	8	24-30	31-34
Supralateral plates	27-29	25-30	29	24-29	22-29
Infralateral plates	28-29	29-32	32	29-31	24-29
Subpectoral plates	small	small	small	enlarged	absent
Enlarged lateral line plates with an enlarged spine	absent	present	present	absent	absent
Ventrolateral plates	distinct row	distinct row	distinct row	limited before anal origin	limited before anal origin
Postocular spine	present	absent	absent	present	absent
Lower pectoral fin	moderately clefted	deeply clefted	deeply clefted	moderately clefted	slightly clefted
Snout barbel	present	present	absent	present	present
Condition between supralateral and infralateral plates	separated	attached	attached	separated	separated

Hypsagonus. Formerly, the condition of the pectoral fin rays was used to separate the two genera, but the condition is now seen to change progressively between the species, as shown in Fig. 2. Other differences between the species include the number of lateral line plates, and the condition of the ventrolateral plates, the subpectoral plates, and the postocular spine (Table 1). These are all of specific significance only. Therefore, *Agonomalus* Guichenot is a junior synonym of *Hypsagonus* Gill. *Hypsagonus* is defined by two derived characters, the long ascending process of the premaxillary and the long interhyal.

This genus is represented by five species, *H. mozinoi*, *H. quadricornis*, *H. corniger*, *H. proboscidalis* and *H. jordani*.

Key to the species of *Hypsagonus*

- 1a. Lateral line plates 20 or less. Subpectoral plates small. Ventrolateral plates present along anal base. 2.
- 1b. Lateral line plates 24 or more. Subpectoral plates enlarged or absent. Ventrolateral plates limited before anal origin. 4.
- 2a. Lateral line plates 15 or more, without an enlarged spine. Postocular spine present. *H. mozinoi*
- 2b. Lateral line plates 12 or less, with an enlarged spine. Postocular spine absent. 3.
- 3a. Snout barbel present. *H. quadricornis*
- 3b. Snout barbel absent. *H. corniger*
- 4a. Postocular spine present. No black stripe on lateral line. Subpectoral plates with an enlarged spine on two subpectoral plates. . . . *H. proboscidalis*
- 4b. Postocular spine absent. A black stripe on lateral line. No subpectoral plates. *H. jordani*

Hypsagonus mozinoi (Wilimovsky et Wilson, 1978)

Fig. 3.

Agonomalus mozinoi Wilimovsky and Wilson, 1978, pp. 73-79, fig. 1 (original description; type locality, central west coast of Vancouver I. south to central California).

Diagnosis. In addition to the characters in the key, *H. mozinoi* is distinguished from other species of *Hypsagonus* in having the following characters: a barbel on snout tip; supralateral and infralateral plates never meeting each other on lateral line; lower pectoral fin rays moderately cleft.

Counts. D. VII-VIII-6-8; A. 10-12; P1. 11-12; P2. I, 2; C. 6+5; Br. 6; V. 34; LLP. 18-20; DLR. 30-36; SLR. 27-29; ILR. 28-29; VLR. from anal origin to caudal base 20-23.

Proportional measurements. Head 3.7-3.9 in SL; predorsal 4.0-4.2; caudal fin 3.6-4.1; pectoral fin 3.2-3.5; pelvic fin 6.8-7.8. Snout 3.4-4.4 in HL; orbit diameter 3.3-4.0; interorbital width 2.4-2.8; dorsal fin 0.9-1.4; anal fin 1.2-1.3; interdorsal distance 4.1-5.6. Body width 1.1-1.2 in its depth. Width of caudal peduncle 2.1-2.9 in its depth. Pelvic-anus length 1.8-2.2 in pelvic-anal length.

Body elongate, compressed, highly elevated at nape. Head compressed, rich in tiny cirri. Supraocular crest expanded dorsally, with many papilla. A blunt postocular spine at posterior upper corner of orbit. Parietal with two blunt spines,

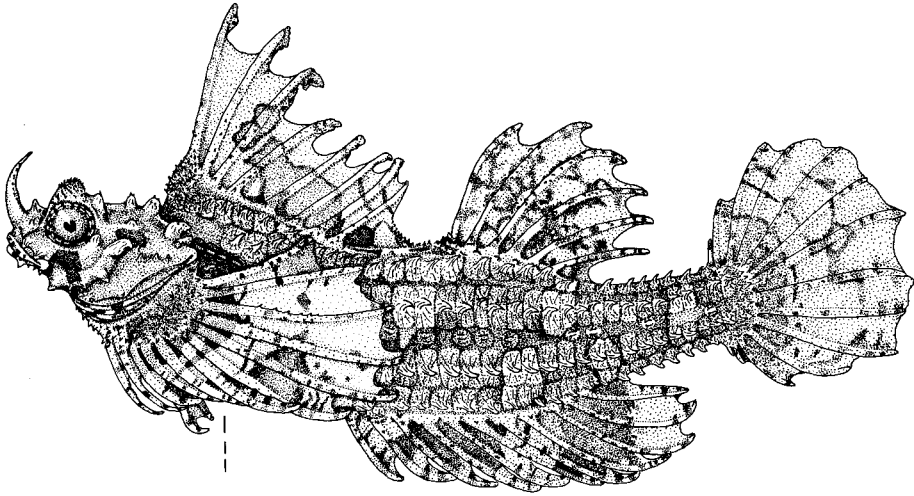

Fig. 3. *Hypsagonus mozinoi* (Wilimovsky et Wilson) : Paratype, UCLA 63-256, 55.1 mm SL.

anterior one smaller than posterior. A small blunt spine at medial side of ocular spines. Pterotic spine small, blunt. Spine on posttemporal large and blunt. Snout round, with a barbel 0.7-0.9 in orbit diameter. Nasal bones with a recurved spine, separated from each other, without an anterolateral median process. Posterior nasal tube short, never reaching upper jaw. Eye moderate in size, without bony tubercles. A spine on second infraorbital bone. Free lachrymal margin with blunt projections. Mouth small, subterminal. Jaw about equal, lower one slightly included in upper one. Maxillary reaching anterior margin of orbit. A papilla on membrane between maxillary and mandible. A blunt knob on posterior end of mandible. A tiny cirrus on dentary. No barbels on maxillary end. Preopercular spine four, uppermost spine large and blunt, slightly recurved posterodorsally, other three small. Opercle with four blunt spines. Teeth on jaws, no teeth on palatine. Prevomerine teeth present or absent. Gill membranes united, free from isthmus.

Dorsal fins two, separated. Interdorsal distance 0.2-0.3 in basal length of first dorsal fin. Longest dorsal spine first or second. Anal fin originating below posterior end of first dorsal fin. Pectoral fin beyond anal origin, lower pectoral fin membrane moderately cleft. Pelvic fin short, without bony tubercles. Caudal fin large, round.

Body covered with prickles and spinous bony plates. Dorsolateral, supralateral, ventrolateral and infralateral rows irregular anteriorly, regular posteriorly. Plates of supralateral and infralateral rows separating each other. Middorsal and ventral plates absent. Dorsal and pectoral fin bases, subpectoral region, chest and belly, rich in prickles. A tiny spine on fourth to seventh lateral line plates present or absent. Subpectoral plates eight or more. Bony tubercles present on all fin rays, without pelvic fin rays.

Color. In preserved specimens, body brown, with fine irregular darker bands.

Head pale with a darker blotch on back, interorbital, cheek, lateral side of snout, opercular and gular regions. Dorsal and anal fins pale, with four to five dark bands. Caudal fin dark with a paler band at middle part. Mouth and gill cavities dark. Peritoneum pale with dark pigments.

Sexual dimorphism. Not examined.

Distribution. Langara I. (54°13.4'N, 132°58.0'W) to San Simeon Pt., California (35°39'N, 121°11'W)

Remarks. *Hypsagonus mozinoi* is closely similar to *H. proboscidalis* in having a postocular spine, but is easily distinguished by its well developed ventrolateral row of plates and absence of an enlarged spine on the subpectoral plates. The species also resembles *H. quadricornis* in having a well developed ventrolateral row of plates, but differs by having a postocular spine, no enlarged lateral line plates with an enlarged spine, and 18-20 lateral line plates. Thus, *H. mozinoi* is considered to be intermediate between *H. proboscidalis* and *H. quadricornis*, as Wilimovsky and Wilson (1978) pointed out.

H. mozinoi is confined to the eastern Pacific coast of North America, living in shallow, rocky reef waters.

Materials. Paratypes, 5 specimens, 37.2-75.9 mm in SL, all from 35°39'N, 121°11'W, San Simeon Pt., San Luis Obispo Co., California. UCLA 63-256, 30 November 1963; UCLA 63-259, 1 December 1936; UCLA 64-82, 22 November 1964.

Hypsagonus quadricornis (Cuvier, 1829)

(Japanese name: Tsuno-shachiuo)

Fig. 4.

Aspidophorus quadricornis Cuvier in Cuvier and Valenciennes, 1829, p. 221 (original description; type locality, Kamchatka).

Hyppocephalus quadricornis. Swainson, 1839, p. 272 (listed).

Agonus quadricornis. Günther, 1860, p. 215 (short description; locality, coast of Kamchatka).

Hypsagonus quadricornis. Gill, 1862c, p. 167 (listed).

Hypsagonus (Cheiragonus) gradiens Herzenstein, 1890, p. 116 (locality, Kamchatka).

Hypsagonus quadricornis quadricornis. Andriashev, 1937, p. 314 (description; locality, Cape Africa, Koriak land, north part of Anadyr Bay, and Bering Strait).

Diagnosis. In addition to the characters in the key, *H. quadricornis* is distinguished from other species of *Hypsagonus* in having the following characters: no postocular spine; dorsolateral plates well developed; ventrolateral plates along anal fin base; posterior plates of supralateral and infralateral rows meeting each other on lateral line; subpectoral plates small with a small knob; lower pectoral fin rays deeply cleft; no black stripe on lateral line.

Counts. D. VIII-XI-5-7; A. 10-11; P1. 12-14; P2. I, 2; C. 5-6+6-7; V. 35-37; Br. 6; LLP. 6-11; PP. 1-4; MDR. 2-8; DLR. 23-29; SLR. 25-30; ILR. 29-32; VLR. 23-35; MVR. 0-9.

Proportional measurements. Head 3.2-3.9 in SL; predorsal 2.9-3.8; pectoral fin 2.6-3.4; pelvic fin 6.2-9.6; caudal fin 4.2-5.5. Snout 2.8-4.0 in HL; orbit diameter 3.1-4.0; interorbital width 4.6-5.6; first dorsal fin 1.5-2.1; anal fin 1.2-1.5. Body width 1.2-1.8 in its depth. Width of caudal peduncle 1.8-3.1 in its depth. Pelvic-anus length 1.7-2.7 in pelvic-anal length.

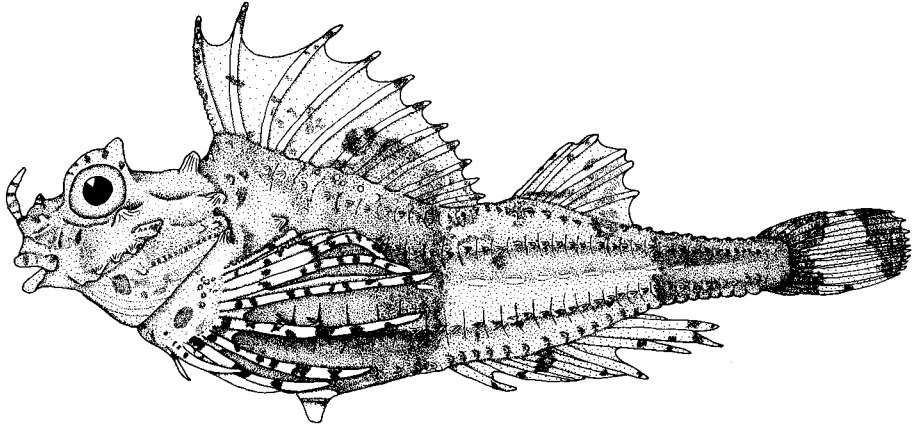

Fig. 4. *Hypsagonus quadricornis* (Cuvier): HUMZ 54448, 73.2 mm SL.

Body short, compressed. Dorsal origin highly elevated just behind head. Head moderate in size, compressed. Supraocular crest expanded dorsolaterally, ending as a blunt spine. No postocular spine. A blunt spine on parietal, with a knob at its base. Posttemporal with a knob. Snout short, round, never beyond anterior tip of upper jaw. Nasal bones attached to each other at anterior end. A barbel on snout tip, 1.0-6.3 on orbit diameter. Nasal spine recurved posterodorsally. Nasal tube short, 8.5-20.0 in orbit diameter. Interorbital wide, concave. Eye moderate in size, without tubercles. A laterally projected knob on second infraorbital bone. No infraorbital plates. Mouth terminal, small. Jaws equal, without flaps and cirri. Maxillary without barbels and cirri, reaching anterior margin of orbit. Free lachrymal margin with a blunt projection. A blunt cleithral spine directed posterolaterally. Preopercular spines four, uppermost spine largest and directed posteriorly, other three spines small and blunt. Teeth on jaws. Palatine and prevomerine teeth present or absent. Gill membranes united, free from isthmus.

Dorsal fins two, well separated. Length of first dorsal fin base in interdorsal distance 0.2-0.4. Longest dorsal spine second or third. Anal fin originating just below the fin membrane of last dorsal spine. Membrane of lower 7-8 pectoral fin rays deeply cleft. Pectoral fin reaching anal origin. Caudal fin large, truncate.

Bony plates of supralateral and infralateral rows meeting posteriorly. Middorsal, dorsolateral, ventrolateral, and midventral plates with a tubercle. First two lateral line plates with an enlarged and expanded spine. Other lateral line plates without spine. Prepelvic plates nonspinous, roughly scattered on breast. Small nonspinous plates surround anus. Gular region without plates. Plates on united gill membrane.

Color. In preserved specimens, body light brown with four bands at first dorsal fin base, anterior and posterior parts of second dorsal fin base, and caudal peduncle. Head dark, paler ventrally. Jaws pale with four darker spots. First and second dorsal fins pale with indistinct blotches. Pectoral fin pale with dark spots. Anal fin pale with darker dots at its tip. Caudal fin pale with darker bands at its base.

and posterior part. Pelvic fin pale with two darker bands, one at base and one at tip. Mouth and gill cavities dark. Peritoneum pale, coarsely pigmented.

Sexual dimorphism. No sexually dimorphic differences in appearance.

Distribution. Niigata Prefecture; Yamagata Prefecture; Iwate Prefecture; Shiraoui, near Tomakomai; northern Japan Sea; Okhotsk Sea; Kuril Is.; east coast of Kamchatka to Anadyr Gulf; Aleutian Is.; Bristle Bay; Alaska Bay to Puget Sound.

Remarks. *Hypsagonus quadricornis* is closely similar to *H. corniger* in having a low number of lateral line plates, a deeply cleft pectoral fin, no postocular spine and enlarged lateral line plates. It differs by having a snout barbel, the first two enlarged lateral line plates with a large spine, and a short distance between the two dorsals (0.2-0.4 in the length of the first dorsal fin base)

H. quadricornis is a small-sized species, living on the rock or pebble bottom in shallow water (15-258 m). It is widely distributed in the northern North Pacific, from the Far East, through the Bering Sea, to the eastern North Pacific. Taranetz (1933) considered that *H. quadricornis* occurred in the northern Okhotsk Sea to Puget Sound, and was replaced by *H. corniger* in the southern Okhotsk Sea, northern Japan and Japan Sea. However, specimens from northern Japan indicated that *H. quadricornis* and *H. corniger* are sympatric in that region.

Materials. 13 specimens, 57.7-79.0 mm SL. BSKU 19010-19011, 52°05'N, 179°42'E, 90-99 m, Aleutian Is., otter trawl, 30 August 1958; HUMZ 54448-5449, 54°59'N, 54°30'E, 256-258 m, Okhotsk coast of Kamchatka, otter trawl, 2 June 1976; HUMZ 56028, 61°55'N, 176°08'E, 71 m, off Nakepeliyak River, western Bering Sea, otter trawl, 28 July 1976; HUMZ 56055, 57°59'N, 156°00'E, 125 m, Okhotsk coast of Kamchatka, otter trawl, 4 June 1976; HUMZ 69027, 58°23'N, 160°00'W, 65 m, eastern Bering Sea, small otter trawl, 19 June 1973; IFES 617, off Iwate Pref., date unknown; ZUMT 18915, Okhotsk Sea, 26 June 1914; 2 specimens in Far Seas Fisheries Laboratory, 62°45'N, 179°30'W, 87 m, Bering Sea, 23 June 1973; 1 specimen in Muroran Fisheries Station of Hokkaido, off Shiraoui, Pacific coast of Hokkaido, 50-100 m, June 1976.

Hypsagonus corniger Taranetz, 1933

(Japanese name: Tongari-shachiuo)

Fig. 5.

Hypsagonus corniger Taranetz, 1933, pp. 72-73, fig. 4 (original description; type locality, Japan Sea south to Peter the Great Bay, and Aniwa Bay).

Hypsagonus quadricornis corniger. Taranetz, 1935, p. 100.

Diagnosis. In addition to the characters in the key, *H. corniger* is distinguished from other species of *Hypsagonus* in having the following characters: no postocular spine; dorsolateral plates well developed; ventrolateral plates along anal fin base; posterior plates of supralateral and infralateral rows meeting each other on lateral line; small subpectoral plates with a small knob; lower pectoral fin rays deeply cleft; no black stripe on lateral line.

Counts. D. VII-7; A. 11; P1. 12; P2. I, 2; C. 7+6; V. 37; Br. 6; LLP. 8; PP. ca 4; MDR. 7; DLR. 26; SLR. 29; ILR. 32; VLR. 22; MVR. 10.

Proportional measurements. Head 3.5 in SL; predorsal 2.9; pectoral fin 2.8; pelvic fin 7.1; caudal fin 5.9. Snout 3.3 in HL; orbit diameter 3.2; interorbital width 1.8; first dorsal fin 2.0; anal fin 1.5. Body width 1.3 in its depth. Width

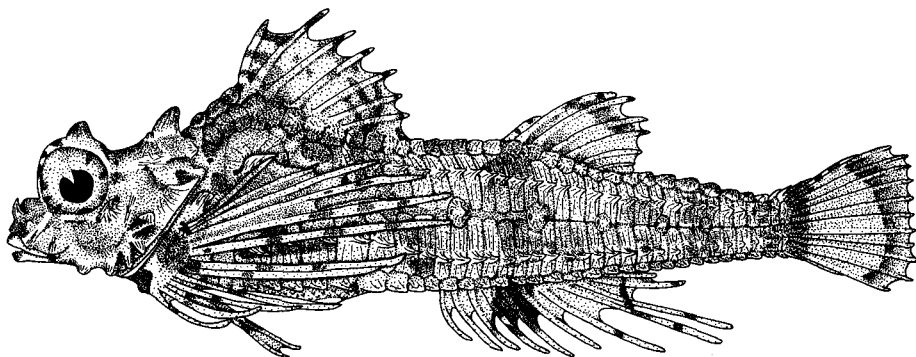

Fig. 5. *Hypsagonus corniger* Taranetz : HUMZ 92905, 79.0 mm SL.

of caudal peduncle 1.5 in its depth. Pelvic-anus length 1.7-2.7 in pelvic-anal length.

Body short, compressed, dorsal contour abruptly elevated at nape, tapering to caudal peduncle. Head moderate in size, compressed, with rough bony surface. Supraocular crest expanded dorsolaterally, ending as a blunt spine. Postocular spine absent. Parietal with a large blunt spine and a small knob. A low knob on posttemporal. Snout short, round, never beyond anterior tip of upper jaw. Sharp spine on nasal directed dorsally. Nasal bones attached to each other by an anterolateral process. No barbel on snout tip. Posterior nasal tube short, never reaching upper jaw, 14.0 in orbit diameter. Eye moderate in size, without tubercles. Interorbital wide, deeply concave. A large blunt knob on second infraorbital. Free lachrymal margin with two blunt projections. Infraorbital plates absent. A broad space between infraorbital bones and lower preopercular ridge. Mouth terminal, small. Jaws equal, upper one without barbels and cirri, reaching anterior margin of orbit. Connecting membrane between upper and lower jaws with a flap. A large blunt cleithral spine, directed posterolaterally. Preopercular spines four, uppermost one large and directed posteriorly, other three small and toward ventrally. Teeth on jaws and prevomer, no teeth on palatine. Gill membranes united, free from isthmus.

Dorsal fins two, well separated. Length of first dorsal fin base in interdorsal distance 0.5. Longest dorsal spine third, longer than the longest second dorsal ray. Anal fin originating below center of interdorsal space, fin membranes moderately cleft. Pectoral fin beyond anal origin, lower seven rays with deeply cleft membrane. Pelvic fin short (left rays torn off). Caudal fin large, truncate.

Body plates of supralateral and infralateral rows separating anteriorly, meeting posteriorly. Middorsal, dorsolateral, ventrolateral, and midventral plates with tubercles. First two lateral line plates enlarged, with a large and expanded spine, third and fourth plates with a large spine, slightly smaller than those of first two plates, other plates with a tiny spine or knob. Six plates with a tubercle present between lateral line and infralateral plates. A space between infralateral and ventrolateral plates with six small plates. Small plates with a tubercle scattered on

breast and around anus. No plates on gular and gill membranes.

Color. In preserved specimens, body light brown, with six indistinct irregular darker bands. A darker blotch between first and second bands on body. Lateral line pores with darker margin. Head darker dorsally, paler ventrally. Anterior and posterior ends of upper jaw dark. Lower jaw with two dark spots, one on anterior tip, one on center. All fins pale. Dorsal fins with darker bands. Anal fin with darker blotches or spots at center and posterior part. Dark spots on basal part of pelvic fin. Pectoral fin with a large dark blotch and spots on upper lobe, lower fin rays with one to three small dark spots. A large dark blotch on pectoral fin base. Caudal fin with two darker bands, one on base, one on posterior margin. Mouth and gill cavities, and peritoneum pale.

Sexual dimorphism. Not examined.

Distribution. Off Sarufutsu, Okhotsk coast of Hokkaido; Aniwa Bay, Sakhalin; Japan Sea south to Peter the Great Bay.

Remarks. *Hypsagonus corniger* closely resembles *H. quadricornis*, as noted in the section of *H. quadricornis*. In 1933, Taranetz described *H. corniger*, on the basis of seven specimens from Peter the Great Bay, Ol'ga Bay and Aniwa Bay, but later (Taranetz, 1935), reduced it to a subspecies of *H. quadricornis*. Schmidt (1950) mentioned that a specimen from Moneron Island was transitional between *H. corniger* and *H. quadricornis*, and followed Taranetz's (1935) classification.

In his comparison of *H. corniger* with *H. quadricornis*, Taranetz (1933) indicated differences in eight characters. The single specimen of *H. corniger* examined here agreed well with the original description. *H. corniger* is clearly distinguishable from *H. quadricornis* in having no barbel on the snout tip, no tubercles on the dorsolateral plates, and the first four lateral line plates with a large spine. Other differences indicated by Taranetz (1933) are variable and overlap between the species.

H. corniger and *H. quadricornis* are sympatrically distributed in northern Japan and its adjacent waters. *H. corniger* is a moderately shallow water fish, occurring at depths of 60-85 m.

Materials. One specimen, 79.0 mm SL. HUMZ 92905, 45°26'N, 142°30'E, depth 75-85 m, off Sarufutsu, Okhotsk coast of Hokkaido, 6 October 1981.

Hypsagonus proboscidalis (Valenciennes, 1858)

(Japanese name: Atsumori-uo)

Fig. 6.

Aspidophorus proboscidalis Valenciennes, 1858, p. 1040 (original description; type locality, Port of Emperor Nicholas, Gulf of Tartary).

Agonomalus proboscidalis. Guichenot, 1866, pp. 254-256 (description; locality, Manche de Tartarie).

Diagnosis. In addition to the characters in the key, *H. proboscidalis* is distinguished from other species of *Hypsagonus* in having the following characters: a barbel on snout tip; supralateral and infralateral plates never meeting each other on lateral line; lower pectoral fin rays moderately cleft.

Counts. D. IX-5-7; A. 11-13; P1. 10-11; P2. I, 2; C. 6+6; Br. 6; V. 34-36; LLP. 24-30; PP. 1; MDR. 0-5; SLR. 24-29; ILR. 29-31; VLR. 5-12;

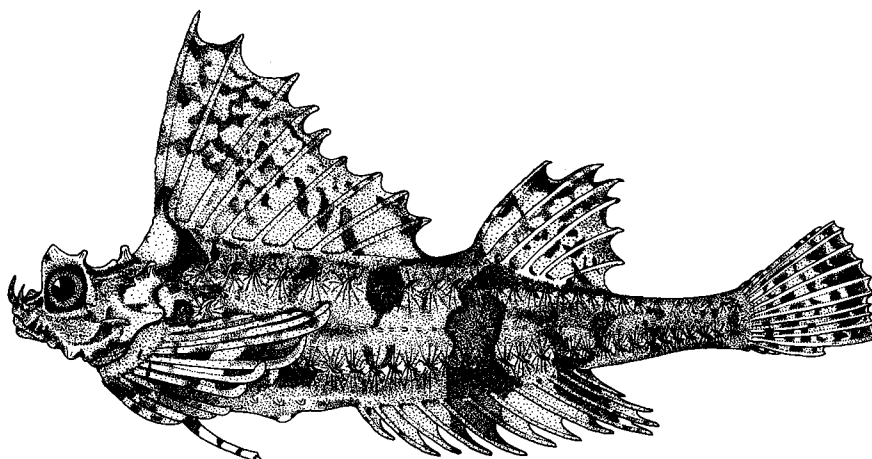

Fig. 6. *Hypsagonus proboscoidalis* (Valenciennes): HUMZ 81252, 81.6 mm SL.

MVR. 0-7.

Proportional measurements. Head 3.7-4.6 in SL; predorsal 3.5-4.6; caudal fin 4.2-5.1; pectoral fin 3.3-4.4; pelvic fin 5.6-9.4. Snout 3.0-4.0 in HL; orbit diameter 3.3-3.7; interorbital width 2.0-2.9; dorsal fin 0.8-1.1; anal fin 0.9-1.3; interdorsal distance 3.7-14.4. Body width 1.3-1.7 in its depth. Width of caudal peduncle 1.5-2.0 in its depth. Pelvic-anus length 1.4-2.2 in pelvic-anal length.

Body elongate, compressed. Dorsal base highly elevated at nape. Head moderate in size, spinous. Supraocular crest expanded posterolaterally, ending as a blunt spine. A small postocular spine on posterior upper corner of orbit. Parietal spine large and blunt, with a small knob anterobasally. A blunt posttemporal spine slightly expanded, directed laterally. Snout round, projecting forward. Barbel on snout variable, 1.2-4.5 in HL. Nasal bones with a sharp spine recurved posterodorsally, attached to each other by an anteromedial process. Posterior nasal tube short, never reaching upper jaw. Eye moderate in size, without bony tubercles. Second infraorbital bone with a large blunt spine. Three spines on free lachrymal margin. Mouth small, subterminal. Jaws equal, upper one reaching anterior margin of orbit. Maxillary without barbels and cirri. Preopercular spines four, uppermost one large and blunt, directed laterally, other three small. No row of spines on opercle. Teeth on jaws, no teeth on palatine. Prevomerine teeth present or absent. Gill membranes united, free from isthmus.

Dorsal fins two, separated, longest spine first or second. Anal fin cleft, originating below last dorsal spine. Pectoral fin sublateral, reaching anal origin or not. Lower pectoral fin membranes cleft to about one third of their rays. Pelvic fin short, slightly behind lower pectoral base. Caudal fin moderate in size, truncate.

Body plates of supralateral and infralateral rows separating each other. Ventrolateral plates with a spine, small, limited between pelvic base to anal origin. Middorsal and midventral plates present or absent. Lateral line plates nonspinous, smooth. Nonspinous prepelvic plates small, thin. Cleithrum with a small plate

supporting a spine. Tiny plates on pectoral fin base. Subpectoral plate two, with an enlarged spine.

Color. In preserved specimens, body brown with numerous spots or large blotches, and bands. Dorsal, pectoral and pelvic fins with small dark spots. Anal and caudal fins with two bands. All fins pale. Mouth and gill cavities dark. Peritoneum pale.

Sexual dimorphism. No sexually dimorphic differences in appearance.

Distribution. Northern Japan; Peter the Great Bay; Gulf of Tartary.

Remarks. Previously, absence of prevomerine teeth has been considered to be one of the diagnostic characters of *H. proboscidalis* (Jordan and Evermann, 1898; Jordan and Starks, 1904; Soldatov and Lindberg, 1930; Taranetz, 1937; Matsubara, 1955). However, this character is clearly variable, prevomerine teeth being either present or absent, and has no diagnostic usefulness. Such infraspecific variation commonly occurs in the genus *Hypsagonus*.

H. proboscidalis has a similar distribution range to *H. jordani*, and is closely similar to the latter in having no ventrolateral plates along the anal fin base, and 10-11 pectoral fin rays. It is easily distinguished, however, by having a postocular spine, two subpectoral plates with an enlarged spine, 24-30 lateral line plates, and no black stripe on the lateral line.

H. proboscidalis occurs in shallow waters. It probably spawns in spring, because specimens with well ripened eggs have been captured in late winter and early spring.

Materials. 21 specimens, 50.0-169.0 mm SL, all from Japanese waters. HUMZ 40536, off Okhotsk coast of Hokkaido; HUMZ 41522, off Kitami, Okhotsk coast of Hokkaido, September 1964; HUMZ 42301, off Usujiri, Funka Bay, Hokkaido, 27 May 1975; HUMZ 49589, off Usujiri; HUMZ 52830, off Washinoki, near Mori-cho, Funka Bay, 2 May 1976; HUMZ 5529-5530, East China Sea; HUMZ 57026, Mano Bay, Sado I., depth 80 m, May 1976; HUMZ 59164, off Futami, Sado I., 23 September 1976; HUMZ 75432, off Omu, Okhotsk coast of Hokkaido, 80 m, 25 August 1977; HUMZ 75433, off Sawaki, Omu-cho, 85 m, 24 August 1977; HUMZ 75437-75439, off Sawaki, 80 m, 24 August 1977, HUMZ 77450, off Kombumori, near Kushiro, 25 m, 22 July 1978; HUMZ 81179, off Akkeshi, Pacific coast of Hokkaido, 29 June 1979; HUMZ 81219, off Akkeshi, 26 June 1979; HUMZ 81251-81252, off Akkeshi, 25-30 m, 24 June 1979; HUMZ 91012, off Shikotsu, Iwate Pref., 100 m, 14 November 1979; IFES 616, Yamada 4 cho-me fisheries station, Iwate Pref.

***Hypsagonus jordani* (Schmidt, 1904)**

(Japanese name: Kumagai-uo)

Fig. 7.

Agonomalus jordani Schmidt, 1904, pp. 130-133, pl. 3 (original description; type locality, Okhotsk Sea).

Agonomalus brashnikowi Pavlenko, 1910, p. 40, pl. 7 (description; locality, Peter the Great Bay).

Diagnosis. In addition to the characters in the key, *H. jordani* is distinguished from other species of *Hypsagonus* in having the following characters: a barbel on snout tip; supralateral and infralateral plates never meeting each other on lateral line; lower pectoral fin rays slightly cleft.

Counts. D. VII-IX-6-8; A. 13-14; P1. 10-11; P2. I, 2; C. 6+6; Br. 6;

V. 33-35; LLP. 31-34; PP. 1; SLR. 22-29; ILR. 24-29; VLR. 6-13.

Proportional measurements. Head 3.8-4.4 in SL; predorsal 3.3-4.4; caudal fin 3.9-5.1; pectoral fin 3.5-4.5; pelvic fin 7.0-11.6. Snout 2.7-3.7 in HL; orbit diameter 3.1-3.7; interorbital width 1.6-2.2; dorsal fin 0.6-0.9; anal fin 0.9-1.5; interdorsal distance 2.3-22.4. Body width 1.3-1.9 in its depth. Width of caudal peduncle 1.3-1.9 in its depth. Pelvic-anus length 1.7-2.7 in pelvic-anal length.

Body compressed, highly elevated just behind head, tapering to caudal peduncle. Head moderate in size, compressed. Supraocular crest expanded posterolaterally, ending as a sharp spine. Postocular spine absent. Parietal spine blunt, with a small knob anterobasally. Posttemporal with a large spine directed posterolaterally. Snout short, round, projecting forward. A barbel on snout, variable in length. Nasal spine sharp, recurved posterodorsally. Nasal bones attached to each other at anterior end by an anteromedial process. Posterior nasal tube short, never reaching upper jaw. Interorbit concave, narrower anteriorly, wider posteriorly. Eye moderate in size, without bony tubercles. Second infraorbital bone with a large spine. Free lachrymal margin with three spines. Mouth small, subterminal, jaws equal. Maxillary without barbels and cirri, reaching between anterior margin of orbit and pupil. Preopercular spines four, upper most expanded thin plate with serrated margin, other three rudimentary. No row of spines on opercle. Gill membranes united, free from isthmus. Teeth on jaws. Prevomerine and palatine teeth present or absent.

Dorsal fins two, separated, its distance variable. Longest dorsal spine first or second. Anal fin originating below last dorsal spine, fin membranes moderately cleft. Pectoral fin sublateral, lower membranes slightly cleft. Pelvic fin short, slightly behind lower pectoral base. Caudal fin moderate in size, truncate.

Body plates of supralateral, infralateral and ventrolateral rows, with a well developed spine. Plates of supralateral and infralateral rows separated from each other. Middorsal and midventral plates absent. Body plates of ventrolateral row

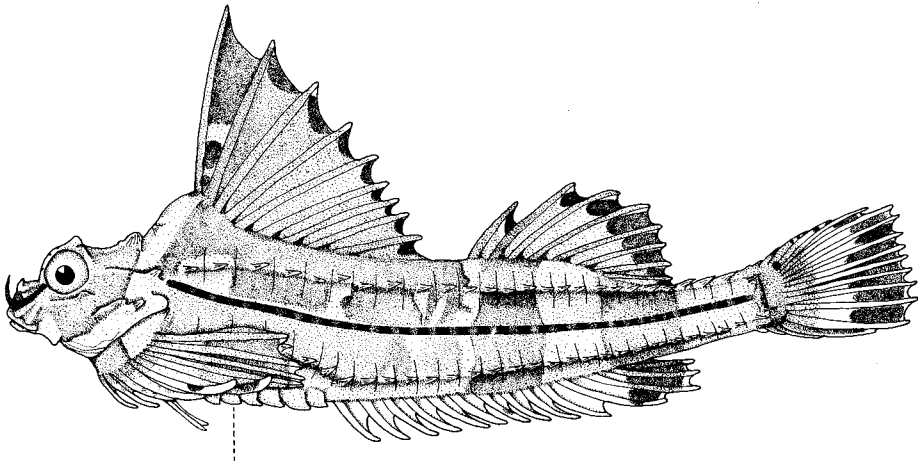

Fig. 7. *Hypsagonus jordani* (Schmidt): HUMZ 75443, 82.0 mm SL.

limited between pelvic fin base and anal origin. Lateral line plates nonspinous, smooth, without enlarged spine. Prepelvic plates nonspinous, small. Tiny plates surrounding anus. A small plate with a sharp spine on cleithrum. No subpectoral plates. Cheek region smooth, without infraorbital plates and prickles.

Color. In preserved specimens, body brown with a transverse dark stripe along lateral line. Four dark bands cross body, first along first dorsal fin base, second at anterior part of second dorsal fin, third at posterior half of second dorsal, fourth at caudal fin base. Head darker dorsally, paler ventrally. A short dark stripe running just below nasal bone from tip of snout to anterior margin of orbit. All fins pale. Tips of dorsal fins and posterior part of anal fin with dark blotches. Pectoral fin with a broad band at upper lobe. Caudal fin with two distinct bands, one on basal part, one on posterior half. Mouth and gill cavities dark. Peritoneum pale.

In fresh or living specimens, body silver, with a transverse black stripe on lateral line, without cross bands.

Sexual dimorphism. Male snout barbel shorter than that in female (Fig. 8-9).

Distribution. Northern Japan south to Kasumi and Kamaishi; coast of Japan Sea, from Wonsan, through Maritime Territory, to Aniwa Bay.

Remarks. The original description of *Hypsagonus jordani*, by Schmidt (1904), was based on five specimens from Terpenie Bay, Aniwa Bay, Peter the Great Bay and Choguchen Bay, south of Wonsan. Subsequently, *H. brashnikovi* was described by Pavlenko (1910) (as *Agonomalus brashnikovi*) on the basis of the following characters: 1) first dorsal spine shorter than second; 2) upper jaw reaching anterior margin of orbit; 3) 31 lateral line plates; 4) uppermost preopercular spine expanded laterally.

With regard to the first character, one of the specimens of *H. jordani* examined here had the first dorsal spine shorter than the second. Other specimens had the first dorsal spine longer or equal in length to the second. Thus, the length of the first

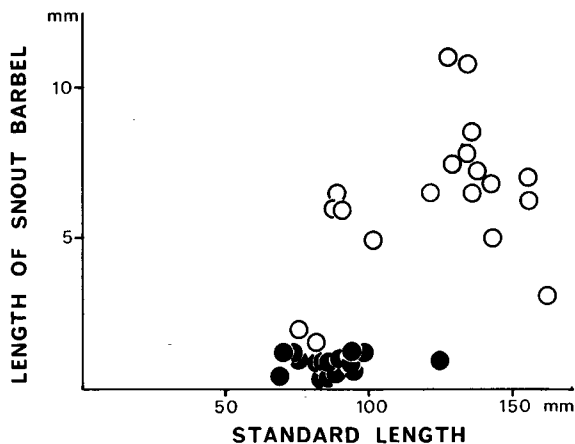

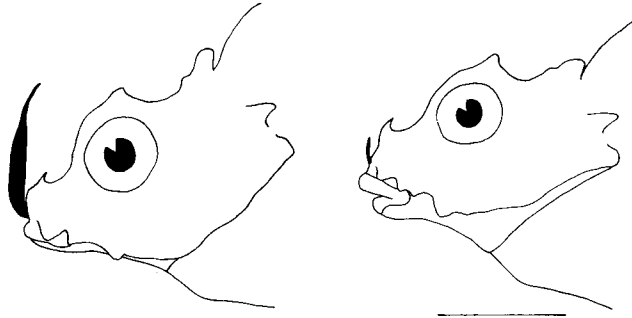

Fig. 9. Sexual dimorphism of snout barbel of *Hypsagonus jordani*. right, male; left, female.

dorsal spine in this species is variable.

The second of Pavlenko's (1910) characters can not be used for separating *H. jordani* from *H. brashnikowi*, since all of the *H. jordani* specimens examined had the upper jaw reaching the anterior margin of the orbit.

As to the number of lateral line plates, Pavlenko considered *H. brashnikowi* to have 31, whereas the type of *H. jordani* has 35-36 lateral line plates (Schmidt, 1904). Specimens of *H. jordani* examined here had 31-34 lateral line plates, intermediate between the types of *H. brashnikowi* and *H. jordani*. Clearly, the difference in the number of lateral line plates should be considered as intraspecific variation.

The fourth character of Pavlenko (1910), shape of the uppermost preopercular spine, was very variable in specimens examined, and cannot be used to distinguish between *H. brashnikowi* and *H. jordani*.

No characters could be found to separate the two species, and accordingly *H. brashnikowi* is considered to be a junior synonym of *H. jordani*.

H. jordani inhabits shallow waters, and is common on stony and sandy bottoms at depths between 10-50 m.

Materials. 38 specimens, 72.2-161.8 mm in SL, all from Japanese waters. HUMZ 12765 and 12775, off Teuri I., Hokkaido, 4 August 1953; HUMZ 17076, 17078-17079, and 17081-17084, Funka Bay, Pacific coast of Hokkaido, 1951-1953; HUMZ 17133-17134, 17137, Funka Bay; HUMZ 17156, Funka Bay, August 1952; HUMZ 17194-17200, 17202-17203, Funka Bay, 1953; HUMZ 17212, Funka Bay, 1953; HUMZ 17220-17224, Funka Bay, 8 August 1951; HUMZ 34212, off Kushiro, Pacific coast of Hokkaido, depth 50 m, 19 July 1974; HUMZ 45830, off Kushiro, 1975; HUMZ 45888, 42°54'N, 144°36'E, 40 m, off Kushiro, 16 July 1975; HUMZ 64725, Funka Bay, 1951-1953; HUMZ 75441-75443, off Omu, Okhotsk coast of Hokkaido, 75 m, 25 August 1977; HUMZ 75945-75946, 42°54'N, 144°16'E, 55 m, off Kushiro, 13 July 1978; IFES 459, off Kamaishi, Iwate Pref., 21 September 1951.

Genus *Percis* Scopoli, 1777

Percis Scopoli, 1777, p. 454 (type, *Cottus japonicus* Pallas).

Hippocephalus Swainson, 1839, p. 272 (type, *Cottus japonicus* Pallas by subsequent designation by Gill, 1862c, p. 167).

External diagnosis. *Percis* is distinguished from other genera of the family Agonidae in having the following characters: two dorsal fins; no snout barbel;

long nasal tube, reaching upper jaw; nasal bones attached to each other; no rostral plate; nasal bone never beyond upper jaw; nasal spine recurved posterodorsally; absence of ethmoidal and parietal spines; no barbel on ventral surface of snout; maxillary with a short flap; no barbel on lower jaw tip; gill membranes united, free from isthmus; six branchiostegal rays; no occipital pit; 4-6 dorsal spines; 5-9 anal fin rays; 13 or less predorsal plates; presence of supralateral plates; breast covered with prickles.

Internal diagnosis. *Percis* differs from other genera of Agonidae in possessing the following osteological characters: lachrymal without median shelf; ascending process of premaxillary shorter than alveolar process; interhyal shorter than epiphyal; plate-like urohyal; no basihyal; three basibranchials; exoccipital never exposed; one tabular bone; four actinosts on pectoral girdle; two postcleithra; absence of postpelvic spine; no pleural rib; first dorsal proximal radial inserted into first space between first and second neural spines, supporting two spines; interneural spaces between well separated two dorsals mostly lacking interdorsal bones; two epurals.

Remarks. This genus is closely similar to *Hypsagonus* in having the advanced dorsal fin just behind the head, no rostral plate, no ethmoidal spine, and no forwardly projecting nasal spine, but differs in having a long nasal tube, no parietal spine and well separated two dorsal fins.

This genus is represented by two species, *P. japonicus* and *P. matsuii*.

Key to the species of *Percis*

- 1a. Middorsal plates 4 or less. Midventral plates absent. Dorsal contour highly elevated just behind head. Body plates with a large sharp spine. Cheek without enlarged infraorbital plates. *P. japonicus*
- 1b. Middorsal plates 10 or more. Midventral plates 9 or more. Dorsal contour never elevated behind head. Body plates with a knob. Cheek with enlarged infraorbital plates. *P. matsuii*.

Percis japonicus (Pallas, 1769)

(Japanese name: Inugochi)

Fig. 10.

Cottus japonicus Pallas, 1769, p. 30, pl. 5, figs. 1-3 (not seen; original description; type locality, Kuril Is.).

Cottus lisiza Bonnaterre, 1788, p. 67, pl. 38, fig. 150 (description; locality, la mer voisine du Kamchatka).

Agonus japonicus. Bloch and Schneider, 1801, p. 105 (description; locality, Kuril Is. and Japan).

Aspidophorus lisiza. Lacépède, 1801, pp. 225-226 (description; locality, Kuril and Japan).

Agonus curilicus Tilesius, 1813, pp. 416-420 (description; substitute name of *Agonus japonicus*).

Agonus stegophthalmus Tilesius, 1813, pp. 427-436, pl. 12 (description; locality, Gulf of Patience).

Phalangistes japonicus. Tilesius in Pallas, 1814, pp. 112-113 (description; Kuril Is. and Japan).

Aspidophorus superciliosus Cuvier in Cuvier and Valenciennes, 1829, p. 215 (description;

substitute name).

Hippocephalus superciliosus. Swainson, 1839, p. 272 (listed).

Hippocephalus japonicus. Gill, 1862c, p. 167 (listed).

Percis japonicus. Jordan and Evermann, 1898, pp. 2034-2036 (well described; locality; Okhotsk Sea, Kuril Is., and Gulf of Patience).

Percis japonica. Jordan and Starks, 1904, pp. 577-578, fig. 1 (description from Jordan and Evermann, 1898).

Diagnosis. In addition to the characters in the key, *P. japonicus* is distinguished from the only known other species, *P. matsuii*, in having the following characters: 6-8 second dorsal fin rays; 7-9 anal fin rays; 12-13 pectoral fin rays; interdorsal distance 1.2-1.7 in HL; length from pelvic base to anus 2.2-2.9 in length from pelvic base to anal; 40-42 vertebrae.

Counts. D. V-VI-6-8; A. 7-9; P1. 12-13; P2. I, 2; C. 6+6; Br. 6; V. 40-42; LLP. 30-40; PP. 1; MDR. 0-1; DLR. 33-40; SLR. 36-40; ILR. 33-37; VLR. 30-38.

Proportional measurements. Head 3.7-4.5 in SL; predorsal 3.4-4.0; pectoral fin 4.1-5.2; pelvic fin 6.7-9.1; caudal fin 4.4-5.7. Snout 3.8-4.4 in HL; orbit diameter 3.6-4.4; interdorsal width 1.8-2.3; dorsal fin 1.5-2.4; anal fin 1.8-2.4. Body width 0.7-0.8 in its depth. Width of caudal peduncle 1.6-2.5 in its depth. Pelvic-anus 2.2-2.9 in pelvic-anal length.

Body oblong, dorsal highly elevated at nape. Head moderate in size, without barbels. Supraocular crest expanded laterally, ending as a blunt spine. No spine on ethmoid, parietal and temporal ridges. Snout short, round. Nasal spine well developed, sharp, recurved posterodorsally. Nasal bones not projecting forward beyond upper jaw, attached to each other at anterior part. Nasal tube long, 2.6-4.1 in orbit diameter. Eye moderate in size, a row of small bony tubercles on upper part. Jaws about equal. Maxillary with a small fleshy flap, reaching below anterior margin of orbit. A large blunt spine on second infraorbital. Free lacrymal margin with two blunt projections. Preopercular spines four, uppermost one large and expanded laterally. Teeth in bands on jaws and prevomer, no teeth on palatine. Gill membranes united, free from isthmus.

Dorsal fins two, well separated, its distance 1.2-1.7 in HL. Anal fin originating below slightly in front of second dorsal origin. Pectoral fin sublateral. Pelvic fin

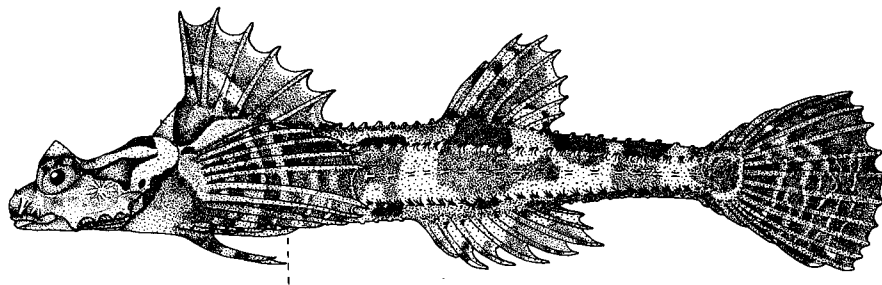

Fig. 10. *Percis japonicus* (Pallas): HUMZ 52749, 189.6 mm SL.

short, never reaching below posterior end of first dorsal fin. Caudal fin large and round.

Head, body and fins covered with numerous tiny prickles. Supralateral and infralateral plates with a large, sharp spine recurved posterodorsally. Dorsolateral and ventrolateral plates rudimentary, forming an indistinct row of small bony tubercles. Middorsal plates present or absent. Midventral plates entirely absent. Lateral line plates nonspinous. Cheek between infraorbital bones and preopercular ridge, wide, covered with prickles.

Color. When fresh, body light brown, with four or five dark brown bands. Belly whitish. Head brown with a saddle-like dark brown blotch on back. A blackish brown stripe running from posterior margin of orbit to opercle. Predorsal, just in front of dorsal origin, with a large dark brown blotch. Dorsal fins dark brown, slightly blackish, with irregular streaks, blotches and whitish margins. Anal fin white, with a dark band. Pectoral fin dark brown, with whitish blotches. Pelvic fin white, dark brown at its base. Caudal fin dark brown, with irregular streaks and a white margin.

In preserved specimens, body brown with dark bands; oral and gill cavities, and peritoneum pale.

Sexual dimorphism. No sexually dimorphic differences in appearance.

Distribution. Northern Japan; Peter the Great Bay; Okhotsk Sea; Kuril Is.; Bering Sea; Gulf of Alaska.

Remarks. *Percis japonicus* is relatively common around northern Japan, being abundant in 150–250 m on muddy sand. It is widely distributed in the Japan, Okhotsk and Bering Seas. First confirmed as occurring in the eastern Bering Sea by Yabe et al. (1981), the species is now known to occur as far east as the Gulf of Alaska.

Materials. 27 specimens, 55.8–324.0 mm SL, by otter trawl. HUMZ 20180, off Kitami, Okhotsk coast of Hokkaido, 9–11 September 1939; HUMZ 33813, 59°28'N, 141°29'W, Gulf of Alaska, 17 July 1968; HUMZ 33829 and 33842, off Mon-betsu, Okhotsk coast of Hokkaido, 6–7 September 1968; HUMZ 34046, 34049 and 34050, off Kushiro, Pacific coast of Hokkaido, depth 450 m, 16 July 1974; HUMZ 37064, off Kushiro, 150–300 m, 6 September 1974; HUMZ 46000–46002, and 46004, 42°45'N, 144°30'E, 300 m, off Kushiro, 15 July 1975; HUMZ 46028 and 46030, 42°53'N, 144°17'E, 180 m, off Kushiro, 15 July 1975; HUMZ 52736 and 52749, 42°02'N, 143°42'E, 330 m, off Hiroo, 23 March 1976; HUMZ 53286, 45°14'N, 143°39'E, 175 m, off Esashi, 1 June 1976; HUMZ 53947, 45°46'N, 142°34'E, off Sarufutsu, 3 June 1976; HUMZ 53962, 45°53'N, 142°42'E, 98 m, off Sarufutsu, 3 June 1976; HUMZ 55242, 53°59'N, 155°04'E, 90–100 m, Okhotsk coast of Kamchatka, 31 May 1976; HUMZ 57847, 56°44'N, 143°30'E, 305 m, eastern North Okhotsk, 16 September 1976; HUMZ 84945, 59°28'N, 178°09'W, 280 m, Bering Sea, 27 June 1979; HUMZ 85345, 59°25'N, 177°39'W, 321 m, Bering Sea, 29 July 1979; HUMZ 86090, 60°00'N, 175°29'W, 123 m, Bering Sea, 1 August 1979; HUMZ 86117, 60°38'N, 179°00'W, 295 m, Bering Sea, 24 July 1979; one specimen in Far Seas Fisheries Research Laboratory, 62°45'N, 179°30'W, 87 m, Bering Sea, 23 June 1973.

***Percis matsuii* Matsubara, 1936**
(Japanese name: Tonbo-inugochi)

Fig. 11.

Percis matsuii Matsubara, 1936, pp. 355–358, fig. 1 (original description; type locality, off the coast of Owase, Mie Prefecture, Japan).

Diagnosis. In addition to the characters in the key, *P. matsuii* is distinguished

from the only other species of *Percis*, *P. japonicus*, in having the following characters: 5 second dorsal fin rays; 5-6 anal fin rays; 11 pectoral fin rays; interdorsal distance 0.8-1.1 in HL; length from pelvic base to anus 5.2-6.4 in length from pelvic base to anal; 37-38 vertebrae.

Counts. D. IV-V-5; A. 5-6; P1. 11; P2. I, 2; C. 6+6; Br. 6; V. 37-38; LLP. 37-39; PP. 3-4; MDR. 10-13; DLR. 27-29; SLR. 35-39; ILR. 32-40; VLR. 18-24; MVR. 9-14.

Proportional measurements. Head 3.9-4.5 in SL; predorsal 3.6-4.1; pectoral fin 4.7-5.4; pelvic fin 8.3-10.7; caudal fin 5.3-6.3. Snout 3.2-3.8 in HL; orbit diameter 2.7-3.3; interorbital width 2.5-3.5; dorsal fin 1.8-2.3; anal fin 1.9-2.5. Body width 0.6-0.9 in its depth. Width of caudal peduncle 1.3-1.9 in its depth. Pelvic-anus length 4.9-7.2 in pelvic-anal length.

Body slender, slightly depressed, tapering to caudal peduncle. No elevation at dorsal origin. Head moderate in size, depressed. Supraocular spine triangular, very blunt, slightly expanded dorsolaterally, ending as a blunt knob. A large blunt knob on parietal, with a supplementary small knob anterobasally. Posttemporal with a knob. Snout short, round. Nasal bones attached to each other anteriorly, not beyond upper jaw tip. Nasal spine sharp, recurved posterodorsally. Nasal tube long, 2.7-4.4 in orbit diameter. Eye large, with a row of bony tubercles. Second infraorbital with a large knob. Free lachrymal margin with two blunt spines. Jaws subterminal, equal. Maxillary beyond anterior margin of orbit. A short flap on end of maxillary. Preopercular spines four, uppermost directed posteriorly, other three posteroventrally or ventrally. Teeth in bands on jaws and prevomer, no teeth on palatine. Gill membrane united, free from isthmus.

Dorsal fins two, well separated. Interdorsal distance 0.8-1.1 in HL. Anal origin just below second dorsal origin. Pectoral fin round, far beyond first dorsal end. Pelvic fin short, reaching first dorsal end. Caudal fin round and small.

Body covered with well developed bony plates. Supralateral and infralateral plates with a blunt spine. Middorsal, dorsolateral, ventrolateral and midventral plates with a knob. Prickles on breast, subpectoral and around anus. Lateral line plates nonspinous, tubular. Interdorsal plates 10-11. Cheek wide, covered with enlarged infraorbital plates.

Color. In preserved specimens, body and head light brown, paler ventrally. All fins pale. Dorsal and anal fins darker distally. Pectoral fin with dark spots.

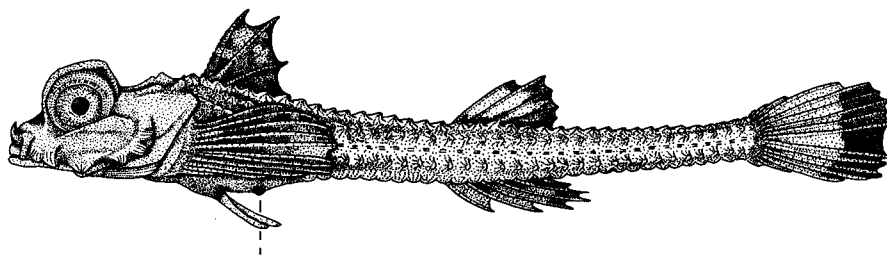

Fig. 11. *Percis matsuii* Matsubara: BSKU 13206, 106.7 mm SL.

Caudal fin with dark bands at its basal and distal parts. Oral and gill cavities, and peritoneum pale.

Sexual dimorphism. No sexually dimorphic differences.

Distribution. Southern Pacific coast of Japan, from off Makurazaki to Choshi.

Remarks. Since the original description of *Percis matsuii* was made by Matsubara (1936), there has been no reexamination of the types. They could not be found in any depositories in Japan (Kyoto University, National Science Museum, Tokyo, Tokyo University of Fisheries, etc.), and it is possible that the type specimens of *P. matsuii* were lost during World War II. Therefore, it is necessary to designate as neotype (International Code of Zoological Nomenclature, 1985: Art. 75) specimen (FRSKU 4632, 136 mm SL), which agrees well with Matsubara's (1936) original description.

This species is small in size, reaching about 20 cm SL, and lives in 200–500 m on muddy sand.

Materials. 18 specimens, 83.0–150.4 mm SL, all from Pacific coast of Japan. BSKU 8229, 9515, off Kochi Pref., Mimase fish market, 11 December 1950; BSKU 12926, 33°10'N, 133°40'E, 350–450 m, off Usa, otter trawl of Taiyu Maru II, 14 May 1968; BSKU 13009–13011, 33°05'N, 133°35'E, 430–460 m, off Suzaki, otter trawl of Taiyu Maru II, 22 May 1968; BSKU 13024, 13206, 32°45'N, 133°15'E, 420–555 m, off east of Cape Ashizuri, 6 June 1968; FAKU 1471, 1478, off Mie Pref., Owase fish market, 6–9 December 1935; FRSKU 4632, neotype, off Mie Pref., Owase fish market, January 1937; FRSKU 17667–17668, Miya fish market, Aichi Pref., 15 March 1952; KSHS 6680, off Kochi Pref., Mimase fish market, 2 December 1967; KSHS 6936–6937, off Muroto-misaki, 430–460 m, May 1968; KSHS 18884, Mimase fish market, 18 December 1980; HUMZ 73020, 33°15'N, 133°55'E, 360–435 m, west of Cape Muroto, 8–9 June 1968.

2. Subfamily Agoninae Gill, 1862

Agoninae Gill, 1862d, p. 259.

External diagnosis. Agoninae are distinguished from other subfamilies of the family Agonidae in having the following characters: no enlarged rostral plate on snout tip; nasal bone projecting forward beyond upper jaw; concave upper margin of orbit; gill membranes joined to isthmus; inferior mouth, lower jaw included in upper one; predorsal region never highly elevated.

Internal diagnosis. Agoninae differ from other subfamilies of Agonidae in possessing the following osteological characters: attachment between lachrymal and nasal; absence of attachment between entopterygoid and metapterygoid; presence or absence of rostral plates; anterior free nasal margin serrated or with a spine; presence of forward projection of nasal; no attachment between prevomer and ethmoid; large anterior process of ethmoid; concave dorsal margin of orbit; three or rare four actinosts on pectoral girdle; no pore between actinosts; no or one tabular bone; no inner pelvic keel; posterior or rarely anterior insertion of dorsal pterygiophore; one spine on first dorsal pterygiophore; continuous spinous dorsal pterygiophore; one epural.

Remarks. The subfamily Agoninae contains five genera, *Freemanichthys*, *Leptagonus*, *Podothecus*, *Agonus*, and *Agonopsis*.

Genus *Freemanichthys* gen. nov.

Type species, *Podothecus thompsoni* Jordan and Gilbert, 1899.

External diagnosis. *Freemanichthys* is distinguished from other genera of the family Agonidae in having the following characters: two dorsal fins; no barbel on snout tip; short nasal tube, never reaching upper jaw; nasal bones attached to each other anteriorly; presence of a rostral plate on ventral surface of snout; nasal bone projecting forward beyond upper jaw; serrated free nasal margin; a single ethmoidal spine; presence of parietal and supraocular spines; a pair of patches of barbels on ventral surface of snout; two patches of barbels on maxillary; no barbels nor cirri on gill membranes and gular region; no barbel on lower jaw tip; gill membranes united, joined to isthmus; six branchiostegal rays; no occipital pit; 8-10 dorsal spines; 6-8 anal fin rays; three predorsal plates; presence of supra-lateral plates; breast covered with spinous enlarged plates.

Internal diagnosis. *Freemanichthys* differs from other genera of Agonidae in possessing the following osteological characters: lachrymal without median shelf; ascending process of premaxillary shorter than alveolar process; interhyal shorter than epihyal; plate-like urohyal; a small basihyal; three basibranchials; no exposure of exoccipital; no tabular bone; four actinosts on pectoral girdle; two postcleithra; absence of postpelvic spine; no pleural rib; first dorsal proximal radial inserted into space between second and third neural spines, supporting one spine; interdorsal spines continuously inserted into interneural spaces between two dorsals; one epural.

Remarks. Since the original description of *Podothecus thompsoni* by Jordan and Gilbert (1899), this species has been included in the genus *Podothecus*. However, the species is clearly distinguishable from species of *Podothecus*, *Agonus*, *Agonopsis* and *Leptagonus* in the subfamily Agoninae in having one ethmoidal spine, a spinous rostral plate on the ventral surface of the snout, a sharp supraocular spine, a serrated free nasal margin, no lateral flange of the lachrymal, four actinosts, the first dorsal proximal radial inserted into a space between the second and third neural spines, two patches of barbels on the ventral surface of the snout, and 29-40 maxillary barbels (Table 2). Also, as discussed in the section on "phylogenetic classification," *P. thompsoni* has deviated from the common ancestor of the Agoninae at the first branching point. The *P. thompsoni* stem is a sister group of the *Podothecus*-*Agonus*-*Agonopsis*-*Leptagonus* stem, and is defined by derived characters as follows: complete cheek cover of infraorbitals; an enlarged rostral plate with a spine; one ethmoidal spine; no tabular bone. Therefore, from the viewpoint of equal ranking, it should be considered to represent a new genus. *Freemanichthys* is hereby formally proposed, and is named in honor of H.W. Freeman, who worked on the family Agonidae for his doctoral thesis. The gender is masculine.

Freemanichthys is represented solely by *F. thompsoni*, which is confined to Far Eastern waters.

Table 2. Comparison of *Freemanichthys* with four related genera, *Leptagonus*, *Podothecus*, *Agonus* and *Agonopsis*.

	<i>Freemanichthys thompsoni</i>	<i>Leptagonus</i>	<i>Podothecus</i>	<i>Agonus</i>	<i>Agonopsis</i>
Enlarged rostral plate	present	absent	absent	present	present
Mesethmoidal spine	1	2 or absent	2	absent	absent
Supraocular spine	present	present	present	absent	present
Free nasal margin	serrated	serrated or smooth	2 spines	absent	3 spines
Lateral flange of lachrymal	absent	absent	present	absent	absent
Number of actinosts of pectoral girdle	4	3	3	3	3
Insertion of first proximal pterygiophore	2	5 or 6	3 or 4	6	6
Snout barbels	2 patches	a pair or absent	2 or 3 patches	1 or 2 pairs	a pair or absent
Barbels on gill membrane	absent	absent	absent	present	present
Number of maxillary barbels	29-40	4	10-18	2-3	2
Cheek cover of infraorbital bones	complete	incomplete	complete	complete	incomplete

Freemanichthys thompsoni (Jordan et Gilbert, 1898)
(Japanese name: Yase-tokubire)

Fig. 12.

Podothecus thompsoni Jordan and Gilbert in Jordan and Evermann, 1898, pp. 2054, 2060-2061
(original description; type locality, Shana Bay, Iturup I.).

Diagnosis. See account of the genus *Freemanichthys*.

Counts. D. VIII-X-5-7; A. 6-8; P1. 15-17; P2. I, 2; C. 6+5; Br. 6; V. 37-40; LLP. 37-40; PP. 3; MDR. 13-15; DLR. 22-24; SLR. 30-32; ILR. 33-36; VLR. 18-20; MVR. 14-16.

Proportional measurements. Head 3.3-3.9 in SL; predorsal 2.9-3.4; pectoral fin 4.6-5.4; pelvic fin 10.5-18.0; caudal fin 6.4-7.9. Snout 2.4-2.7 in HL; orbit diameter 3.0-3.7; interorbital width 4.4-5.8; dorsal fin 2.5-3.0; anal fin 2.2-2.7. Body width 0.7-0.9 in its depth. Width of caudal peduncle 1.0-1.3 in its depth. Pelvic-anus length 5.6-11.2 in pelvic-anal length.

Body elongate, depressed anteriorly, compressed posteriorly. Head moderate in size, depressed. Nasal bone with a small spine directed dorsally, its free margin finely serrated. Nasal bone projecting forward beyond upper jaw, attaching anteriorly. Nasal tube short, never reaching upper jaw. Snout highly depressed, paddle-like. An enlarged rostral plate with a spine recurved posteroventrally, on midventral surface of snout. A pair of patches of barbels on ventral surface of snout. Nasal-ethmoidal ridge finely serrated, joined on midline, ending as a strong spine directed posterodorsally. Spines on supraocular and parietal large, well developed. Parietal spine with a supplementary blunt spine, recurved posterodorsally. A small spine blunt, slightly behind supraocular spine. Temporal ridge distinct, ending as a sharp posttemporal spine. Lower jaw included in upper one. Upper jaw reaching anterior margin of pupil. Maxillary with two patches of

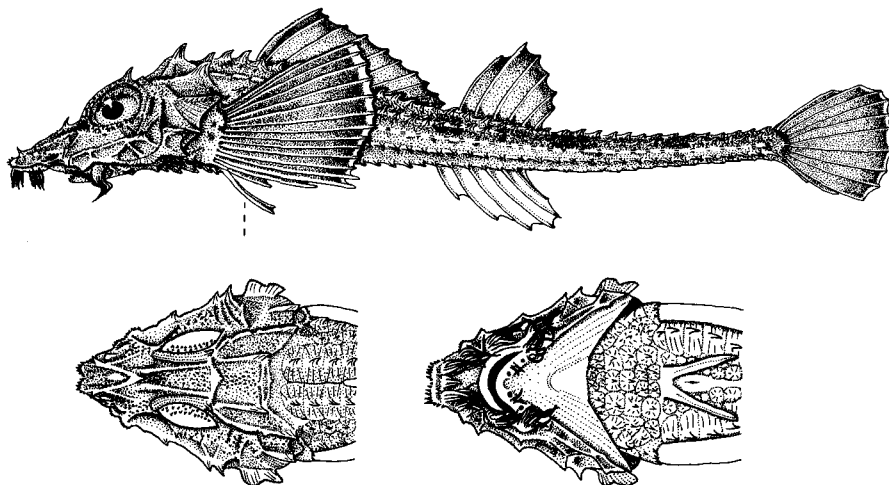

Fig. 12. *Freemanichthys thompsoni* (Jordan et Gilbert): HUMZ 68371, 149.2 mm SL.

barbels, anterior one 10-16, posterior one 16-25. Two short barbels on dentary. Eye moderate in size, with tubercles on upper part. Infraorbital ridge finely serrated, with four spines, two on lachrymal, one on first infraorbital, one on second infraorbital with a supplementary knob or spine. A ridge connecting infraorbital ridge with anterior margin of orbit, with a spine. Free infraorbital margin finely serrated with small spines. Interorbital wide, concave. Anterior frontal ridge distinct, high. Preopercular spines four, uppermost large and expanded laterally, second small and sharp, lower two blunt and tiny. Opercle with a laterally expanded keel. Gill membranes united, fused to isthmus. Teeth on jaws, no teeth on palatine and prevomer.

Dorsal fins two, well separated, distance 5.1-13.5 in HL. Anal fin originating between two dorsal fins. Pectoral fin sublateral, never reaching anal origin. Pelvic fin slender, short. Anus slightly behind pelvic fin base. Caudal fin moderate in size, round.

Body plate with a well developed spine. A spine on each midventral plate, small. Plate of lateral line with a spine anteriorly, lacking a spine posteriorly. Breast tightly covered with enlarged spinous plates. Prickles or tubercles scattered on head. Subpectoral plates 5-8, with a spine. Cheek plates with a spine, variable, absent to three.

Color. In preserved specimens, body brown, darker dorsally, paler ventrally. Four broad bands on back, two on caudal peduncle, two on second dorsal fin base. Dark irregular blotch or spots on body. Head darker dorsally, paler ventrally. A narrow stripe from tip of snout to anterior margin of orbit. A dark line on just behind head. Ventral surface of snout dark. Snout barbels dark. Dorsal fins pale, darker distally. Pelvic and anal fins pale. Pectoral fin pale, with darker indistinct five or six bands, with paler margin. Caudal fin dark, paler marginary. Mouth cavity and peritoneum pale. Gill cavity densely pigmented.

Sexual dimorphism. Pelvic fin longer in male (10.5-11.5 in SL) than those in female (16.5-18.0).

Distribution. Japan Sea south to Cape Pestshnyzoff of Korea and Kasumi fish market of Japan; Pacific coast of northern Japan south to Kamaishi, Iwate Pref.; Okhotsk coast of Hokkaido; Shana Bay, Iturup I.

Remarks. *Freemanichthys thompsoni* is similar to *Leptagonus decagonus* and *L. frenatus* in having a serrated nasal margin, but differs by having two patches of barbels on the ventral surface of the snout, a rostral plate, and 29-40 maxillary barbels.

F. thompsoni is common around Hokkaido, and is frequently captured by otter trawl on the stony bottom at depths from 100 to 300 m.

Materials. 30 specimens, 67.9-174.1 mm SL. HUMZ 5619, off Maritime Territory; HUMZ 5620, off Obama, Fukui Pref., HUMZ 45059-45060, 44°34'N, 140°48'E, depth 198-237 m, Musashi Bank, 6 July 1975; HUMZ 45490, 42°32'N, 143°48'E, 87 m, 6 September 1975; HUMZ 45690, 42°51'N, 144°35'E, 82 m, 16 July 1975; HUMZ 46273, 44°48'N, 143°18'E, 134-139 m, southern Okhotsk Sea, 1 July 1975; HUMZ 46422-46423, 44°34'N, 140°48'E, 198-237 m, Musashi Bank, 6 July 1975; HUMZ 47523 and 47545, 42°32'N, 143°48'E, 87 m, off Hiroo, 6 September 1975; HUMZ 65275, Funka Bay, August 1952; HUMZ 67457, 43°11'N, 145°48'E, 73 m, 3 July 1977; HUMZ 67547, 42°20'N, 143°45'E, 207-210 m, 25 May 1977; HUMZ 67639, 43°11'N, 145°49'E, 76 m, 23 May 1977; HUMZ 68371, 68374, 68379-68381, 68383 and

68386, 43°48'N, 141°11'E, 185-194 m, 15 May 1977; HUMZ 69425, Funka Bay, 1 August 1952; HUMZ 73009, northern Japan Sea, 15 March 1975; HUMZ 76035-76037, 45°18'N, 142°52'E, 120-122 m, off Hamatonbetsu, 4 October 1977; HUMZ 87151-87153, off Muroran, 105-110 m, 30 April 1980.

Genus *Leptagonus* Gill, 1862

Leptagonus Gill, 1862c, p. 167 (type species, *Aspidophorus spinosissimus* Kröyer).

Sarritor Cramer in Jordan and Evermann, 1896, p. 448 (type species, *Odontopyxis frenatus* Gilbert).

External diagnosis. *Leptagonus* is distinguished from other genera of the family Agonidae in having the following characters: two dorsal fins; no barbel on snout tip; short nasal tube, never reaching upper jaw; nasal bones attached to each other anteriorly; absence of an enlarged rostral plate; tiny plates or tubercles on ventral surface of snout; nasal bone projecting forward beyond upper jaw; nasal bone with a serrated or smooth free margin and a large spine recurved posterodorsally; absence or presence of a pair of ethmoidal spines; a supraocular and a parietal spines; absence of two barbels on ventral surface of snout; maxillary with four barbels; no barbel on lower jaw tip; gill membranes united, widely fused with isthmus; six branchiostegal rays; no occipital pit; 5-9 dorsal spines; 6-8 anal fin rays; 5-7 predorsal plates; presence of supralateral plates; breast covered with enlarged plates.

Internal diagnosis. *Leptagonus* differs from other genera of Agonidae in possessing the following osteological characters: lachrymal without a median shelf; ascending process of premaxillary shorter than alveolar process; interhyal shorter than epihyal; plate-like urohyal; absence or presence of basihyal; three basibranchials; exoccipital never exposed; no tabular bone; three actinosts on pectoral girdle; two postcleithra; no postpelvic spine; no pleural rib; first dorsal proximal radial inserted into fifth or sixth space between fifth and sixth or sixth and seventh neural spines, supporting one spine; interdorsal spines continuously inserted into interneural spaces between separated two dorsals; one epural.

Remarks. The genus *Leptagonus* was established by Gill (1862c) on the basis of *Aspidophorus spinosissimus* Kröyer (= *Leptagonus decagonus*). On the other hand, the genus *Sarritor* was established by Cramer (1896) based on *Odontopyxis frenatus* Gilbert. Andriashev (1954) noted that *Sarritor* is closely related to *Leptagonus*. These two genera are more similar to each other than to any other genera of Agonidae. Especially, *Leptagonus decagonus*, the only known species of *Leptagonus*, highly resembles *Sarritor frenatus*, one of the two known species in *Sarritor*. Previously, many authors considered that *L. decagonus* lacked both prevomerine teeth and barbels on the ventral surface of snout (Jordan and Evermann, 1898; Soldatov and Lindberg, 1930; Schmidt, 1936; Andriashev, 1937, 1954; Taranetz, 1937; Matsubara, 1955; Ueno, 1967). Most of the specimens of *L. decagonus* examined here had prevomerine teeth, although they were absent in a few. Despite many of the specimens of *L. decagonus* examined lacking barbels on the ventral surface of the snout, 11 out of 40 specimens bore either a pair of barbels or a rudimentary barbel on the left or right side. Therefore, characters formerly used to distinguish between these two genera are not appropriate, and there is no reason

for separating *Sarritor* from *Leptagonus*. Therefore, *Sarritor* is a junior synonym of the latter, which is represented by three species, *L. decagonus*, *L. frenatus* and *L. leptorhynchus*.

Key to the species of *Leptagonus*

- 1a. Maxillary barbel reaching preopercular ridge. No ethmoidal spine. Nasal-ethmoid ridge smooth. Mid prepelvic plate with a spine. Barbel on ventral surface of snout rudimentary or absent. *L. decagonus*
- 1b. Maxillary barbel never reaching second infraorbital spine. A pair of ethmoidal spines present or absent. Nasal-ethmoid ridge serrated or smooth. Mid prepelvic plates without spine. A pair of barbels on ventral surface of snout. 2.
- 2a. Free nasal margin serrated, with small spines. Second infraorbital spine with a supplementary knob. *L. frenatus*
- 2b. Free nasal margin smooth. Second infraorbital spine without supplementary knob. *L. leptorhynchus*

Leptagonus decagonus (Schneider, 1801)

(Japanese name: Chigo-tokubire)

Fig. 13.

Cottus cataphractus. Fabricius, 1780, pp. 155-156 (not Linnaeus).

Agonus decagonus Schneider in Bloch and Schneider, 1801, p. 105, pl. 27 (original description; erroneously recorded from East-Indies; type locality, Greenland).

Cottus decagonus. Tilesius, 1809, p. 216 (compared with *Agonus segaliensis*).

Aspidophorus decagonus. Cuvier in Cuvier and Valenciennes, 1829, p. 223 (description).

Hippocephalus decagonus. Swainson, 1839, p. 272 (listed).

Aspidophorus spinosissimus Krøyer, 1845, p. 250 (description; locality, Greenland).

Agonus malmarmoides Deslongchamps, 1853, p. 168, pl. 10, figs. 1-3 (description; locality, Newfoundland).

Agonus spinosissimus. Günther, 1860, pp. 214 and 524 (description; locality, Greenland).

Leptagonus spinosissimus. Gill, 1862c, p. 167 (listed).

Agonus malmarmoides. Day, 1881, p. 67 (mentioned in text).

Brachyopsis decagonus. Jordan and Gilbert, 1883, pp. 724 and 727 (description; distribution, Greenland to Norway).

Leptagonus decagonus. Jordan and Gilbert, 1883, p. 955 (listed).

Podothecus decagonus. Goode and Bean, 1896, p. 282, pl. 72, fig. 259 (description).

Diagnosis. In addition to the characters in the key, *L. decagonus* is distin-

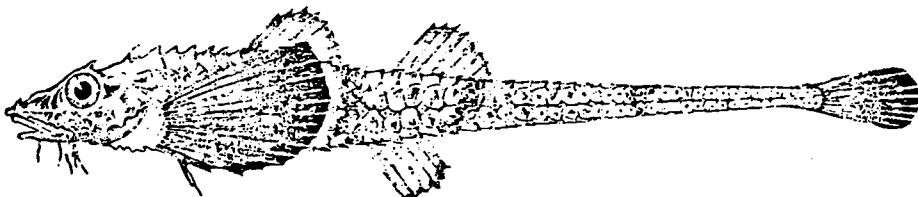

Fig. 13. *Leptagonus decagonus* (Bloch et Schneider). Taken from Leim and Scott, 1966.

guished from other species of *Leptagonus* in having the following characters: serrated free nasal margin; second infraorbital spine with a supplementary spine or knob; 21-28 lateral line plates.

Counts. D. V-VIII-5-8; A. 6-8; P1. 15-17; P2. I, 2; C. 6+5; Br. 6; V. 44-49; LLP. 21-28; PP. 5-6; MDR. 15-19; DLR. 21-28; SLR. 36-41; ILR. 39-43; VLR. 19-23; MVR. 14-21.

Proportional measurements. Head 4.0-5.0 in SL; predorsal 2.9-3.5; pectoral fin 3.8-5.3; pelvic fin 4.9-20.9; caudal fin 6.3-9.0. Snout 2.8-3.3 in HL; orbit diameter 3.4-4.4; interorbital width 3.9-5.5; dorsal fin 2.7-3.8; anal fin 1.8-2.3. Body width 0.8-1.0 in its depth. Width of caudal peduncle 0.7-1.0 in its depth. Pelvic-anus length 4.9-7.5 in pelvic-anal length.

Body elongate, highest just behind head, tapering to caudal peduncle. Head moderate in size, triangular in lateral view. Nasal bone with a serrated ridge, anterior margin with small spines, ending as a dorsolaterally recurved spine. Nasal bones projecting beyond upper jaw, its distance 7.1-14.0 in HL, attached to each other anteriorly. Nasal tube short, never reaching upper jaw. Snout pointed, depressed. Tiny bony tubercles on ventral surface of snout present or absent. A pair of rudimentary barbels on snout present or absent. Nasal-ethmoid ridge finely serrated, converging on each other in midline. Ethmoidal spine absent. A strong spine on supraocular and parietal. Temporal ridge prominent, ending as a post-temporal spine. Lower jaw included in upper one. Maxillary reaching center of orbit, with four barbels at its posterior end, posterodorsal one long, 2.1-3.2 in HL. Barbel on dentary divided distally, short. Eye moderate in size, with finely serrated bony tubercles on eye ball. Infraorbital ridge with three spines, one on lachrymal, one on first infraorbital, one on second infraorbital, with a supplementary small knob. Free lachrymal margin serrated, with two spines. Cheek incompletely covered with second infraorbital never reaching lower preopercular ridge. A deep groove between supraocular crest and inner frontal ridge. Preopercular spines four, uppermost with a supplementary knob. Gill membranes united, joined to isthmus, with a much narrow free margin. Opercle with a low ridge. Teeth on jaws, no teeth on palatine. Prevomerine teeth present or absent.

Dorsal fins two, well separated each other. Interdorsal distance 2.6-6.6 in HL. Anal origin at center nearly of interdorsal region. Pectoral fin sublateral, lower four or five rays slightly thickened. Pelvic fin short, just below pectoral fin base. Caudal fin moderate in size, round. Anus slightly behind pelvic fin base.

A spine on plates of dorsolateral row, large and sharp anteriorly, small and blunt posteriorly. Plates of supralateral, infralateral and ventrolateral rows with a spine anteriorly, and a knob posteriorly. Midventral plates smooth, without a spine. Lateral line plates smooth, anterior 3-6 plates with a sharp spine. Subpectoral plates 1-7 between lateral line and infralateral plates. Breast entirely covered with spinous plates, plates on midline and free margin of gill membrane with an enlarged spine. Tiny spinous plates on middorsal surface of head, below temporal ridge, ventral half of orbital margin and opercular margin. Small plates on gular and isthmus. Small and tiny plates present on a region between pelvic base and anal origin. Infraorbital plate 2-5, with a blunt spine.

Color. When fresh, body grayish brown, irregular dark brown blotches dorsal-

ly. Head brown dorsally, grayish brown ventrally. A dark brown streak from tip of snout to just anterior margin of orbit. Dorsal, anal and pectoral fins whitish, dark brown distally. Pelvic fin white. Caudal fin dark brown, whitish on rays.

In preserved specimens, body brown, mouth and gill cavities, and peritoneum pale.

Sexual dimorphism. Pelvic fin longer in male (4.9-12.5 in SL) than those in female (15.4-20.9).

Distribution. Northern Okhotsk Sea; Bering Sea; Laptev Sea; Kara Sea; White Sea; Barentz Sea; Greenland; Iceland; Norwegian Sea; Newfoundland.

Remarks. The genus *Leptagonus* contains three species, *L. decagonus*, *L. frenatus* and *L. leptorhynchus*.

L. decagonus is closely similar to *L. frenatus* in having a serrated nasal margin, a spine on the second infraorbital with a supplementary knob, and a more developed spine on the body plates, but differs from the latter in having long maxillary barbels, rudimentary barbels sometimes present on the ventral surface of the snout, and 21-28 lateral line plates. *L. decagonus* is distinguished from *L. leptorhynchus* in having a serrated free nasal margin, rudimentary barbels sometimes present on the ventral surface of the snout, a spine on the second infraorbital with a supplementary knob, a more developed spine on the body plates, and long maxillary barbels.

L. decagonus is a benthic dweller on muddy or sandy bottoms (120-930 m in depth), and is common in the Okhotsk, Bering and Arctic seas, and the northern North Atlantic. According to Andriashchev (1954), this fish feeds on pelagic and benthic crustaceans and polychaets. The spawning season is in June and July off the Murman coast, and in May and June off Iceland. In Iceland, pelagic larvae occur from the end of May. The numbers of mature eggs recorded range from 480-1750, being 1.5-1.9 mm in diameter.

Materials. 40 specimens, 84.1-179.7 mm SL. HUMZ 54208, 54209, 61°54'N, 179°03'W, southeast of Navarin, depth 126-128 m, 2 August 1976; HUMZ 54299, 58°30'N, 150°01'E, 125-127 m, Okhotsk Sea, 10 June 1976; HUMZ 56052, 61°53'N, 179°02'W, 130-131 m, off Navarin, 2 August 1976; HUMZ 56277, 56279-56280, 56282, 56285, 56294, 56296-56298, 56300-56301, 57°59'N, 150°00'E, 164-168 m, Koni Peninsula, 10 June 1976; HUMZ 58020, 56°40'N, 143°22'E, 310 m, Okhotsk Sea, 22 September 1976; HUMZ 58261, 57°26'N, 149°16'E, 220 m, Okhotsk Sea, 11 September 1976; HUMZ 60364, 60373, 60381, 60398-60399, 60402, 56°37'N, 143°35'E, 240 m, Okhotsk Sea, 22 September 1976; HUMZ 62267-62271, 44°58'N, 60°40'W, off Canso, 13 August 1965; HUMZ 81040, Canadian Arctic; HUMZ 85196, 61°12'N, 178°02'W, 156 m, eastern Bering Sea, 23 July 1979; HUMZ 85401, 61°30'N, 175°52'W, 100 m, eastern Bering Sea, 20 July 1979; HUMZ 85476, 85478-85479, 60°59'N, 175°55'W, 110 m, eastern Bering Sea, 21 July 1979; HUMZ 85480, 61°00'N, 175°58'W, 110 m, eastern Bering Sea, 21 July 1979; HUMZ 85497-85498, 60°30'N, 175°05'W, 106 m, eastern Bering Sea, 21 July 1979; HUMZ 85501, 85503, eastern Bering Sea, 21 July 1979; HUMZ 86363, 62°37'N, 173°29'W, 67 m, eastern Bering Sea, 19 July 1979.

Leptagonus frenatus (Gilbert, 1896)
(Japanese name: Yasetengu-tokubire)

Fig. 14.

Odontopyxis frenatus Gilbert, 1896, pp. 435-437, pl. 30 (original description; type locality, both sides of Alaskan Peninsula and Aleutian Is.)

Sarritor frenatus. Jordan and Evermann, 1896, p. 448 (listed).

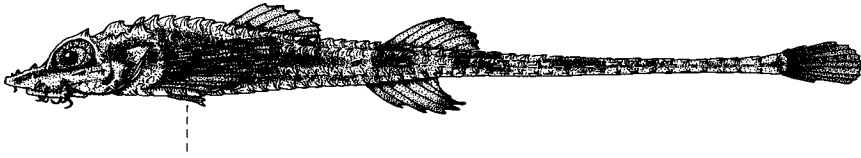

Fig. 14. *Leptagonus frenatus* (Gilbert): HUMZ 52737, 216 mm SL.

Sarritor frenatus frenatus. Andriashev, 1937, p. 315 (compared with *S. frenatus occidentalis*).
Sarritor frenatus occidentalis Andriashev, 1937, p. 315 (description; locality, Anadyr Gulf and Natalie Bay).

Diagnosis. In addition to the characters in the key, *L. frenatus* is distinguished from other species of *Leptagonus* in having the following characters: first infraorbital with a spine at center; 29-43 lateral line plates.

Counts. D. VI-VIII-6-8; A. 6-7; P1. 15-16; P2. I, 2; C. 6+5; Br. 6; V. 45-48; LLP. 29-43; PP. 5-7; MDR. 14-18; DLR. 26-29; SLR. 41-43; ILR. 41-45; VLR. 21-26; MVR. 16-20.

Proportional measurements. Head 4.2-4.9 in SL; predorsal 3.2-3.6; pectoral fin 5.1-6.5; pelvic fin 10.2-21.7; caudal fin 7.5-10.8. Snout 2.8-3.4 in HL; orbit diameter 2.9-3.6; interorbital width 4.8-6.1; dorsal fin 2.7-3.6; anal fin 2.1-2.9. Body width 0.7-0.9 in its depth. Width of caudal peduncle 0.7-1.1 in its depth. Pelvic-anus length 5.7-8.1 in pelvic-anal length.

Body slender, depressed. Head moderate in size, spinous. Nasal bone with a serrated ridge ending as a strong spine, anterior free margin serrated. Nasal bone projecting forward, beyond upper jaw, its distance 9.6-27.1 in HL, attached to each other anteriorly. Nasal tube short, never reaching upper jaw. Snout pointed, depressed. Tiny tubercles on ventral surface of snout. A pair of long barbels reaching anterior margin of nasal bone. Nasal-ethmoid ridge serrated, usually ending as a strong spine, converging with each other in midline. A strong spine on supraocular and parietal. Temporal ridge prominent, ending as a posttemporal spine. Lower jaw included in upper one. Upper jaw reaching below between anterior margin of orbit and anterior margin of pupil. Maxillary with four barbels, never reaching below spine of second infraorbital, 3.5-7.6 in HL. A short barbel on dentary, may be divided distally. Eye moderate in size, with a row of tubercles at upper part. Interorbital region concave, with a frontal ridge. Second infraorbital with three spines or a spine with a supplementary knob. First infraorbital with a spine on center and a spine on free margin. A sharp spine on center of lachrymal, usually with a supplementary spine. Free lachrymal margin with two spines posteriorly, anterior lobe serrated. Cheek incompletely covered with expanded second infraorbital. Preopercular spines three, usually uppermost with a supplementary knob. Teeth on jaws and prevomer, no teeth on palatine. Gill membranes united, joined to isthmus.

Dorsal fins two, well separated. Interdorsal distance 2.8-6.9 in HL. Anal fin originating slightly anterior to second dorsal fin. Pectoral fin sublateral, lower five

rays slightly thickened. Pelvic fin short, slender. Caudal fin moderate in size, round. Anus slightly behind pelvic fin base.

A sharp spine on plates of dorsolateral row, recurved posterodorsally. A sharp spine on plates of supralateral and infralateral rows, large anteriorly, small posteriorly. Ventrolateral and midventral plates with a blunt spine anteriorly, reduced to a knob posteriorly. Plates on breast and midventral row smooth, without a spine. Lateral line plates tubular, smooth, first 3-4 plates with a sharp spine. Tiny tubercles on dorsal surface of head, head between temporal ridge and opercle, and free opercular margin. Lower half of orbital margin with tiny plates. Area between postorbital bone and preopercular ridge with three or four enlarged plates. Cheek between infraorbital bones and lower preopercular ridge covered with non-spinous plates. Subpectoral plates with a blunt spine, 4-9. Plates on gular and united gill membrane small, nonspinous. Anus surrounded by small plates.

Color. When fresh, body brown or greenish brown, whitish ventrally. Irregular blotches and indistinct bands on body dark brown. A dark brown stripe running from tip of snout to anterior margin of orbit. Head brown dorsally, light ventrally, with dark brown spots laterally. Dorsal fins dark brown, with white spots. Anal fin white, with a dark brown band marginally. Pectoral fin dark brown, with white spots. A white blotch on upper base of pectoral fin present or absent. Caudal fin dark brown, with whitish rays. Pelvic fin white or brown.

In preserved specimens, peritoneum light brown, mouth and gill cavities dark.

Sexual dimorphism. Pelvic fin longer in male (10.2-13.9 in SL) than those in female (11.4-21.7). Color of pelvic fin white in female, brown or dark brown in male.

Distribution. Off Hiroo, Pacific coast of Hokkaido; Japan Sea, Peter the Great Bay to Gulf of Tartary; Okhotsk Sea; Bering Sea; Pacific coast of Aleutian Is.; Gulf of Alaska.

Remarks. *Leptagonus frenatus* was separated into two subspecies, *Sarritor frenatus frenatus* and *S. f. occidentalis*, by Andriashev (1937), on the basis of differences in the color of the pectoral fin and the number of interdorsal plates. They were later synonymized by Kanayama (1980).

L. frenatus resembles *L. decagonus* in external morphology, but is easily distinguished by having a short maxillary barbel, a pair of long barbels on the ventral surface of the snout, and 29-43 lateral line plates. *L. frenatus* is also distinguished from *L. leptorhynchus*, by having a serrated free nasal margin, the second infraorbital spine with a supplementary spine or knob, and more developed spines on the body plates.

L. frenatus is common in the Bering Sea, living on the muddy sand or rock bottom in 50-250 m.

Materials. 48 specimens, 130.2-238.2 mm SL. HUMZ 12955-12960, 12962 and 12964-12965, 44°30'N, 148°20'E, off Pacific coast of Iturup I., 30 June to 12 July 1954; HUMZ 44869, 55°28'N, 165°16'E, depth 160-195 m, off Komandorskie I., 17 May 1975; HUMZ 44956, 50°45'N, 157°07'E, 88-90 m, off Cape Lopatka, 13 May 1975; HUMZ 45008, 49°07'N, 155°08'E, 295-300 m, 24 June 1975; HUMZ 46201 and 46203-46204, 55°28'N, 165°16'E, 160-195 m, off Komandorskie I., 17 May 1975; HUMZ 51530, 42°02'N, 143°43'E, 355 m, off Hiroo, 24 March 1976; HUMZ 56277, 42°01'N, 143°44'E, 360 m, off Hiroo, 24 March 1976; HUMZ

52737-52738, 42°02'N, 143°42'E, 330 m, off Hiroo, 23 March 1976; HUMZ 55098, 51°25'N, 158°04'E, 135-140 m, eastern coast of Kamchatka, 21 May 1976; HUMZ 56135, 53°56'N, 160°26'E, 215-240 m, 20 May 1976; HUMZ 56363, 55°10'N, 166°57'E, 155-165 m, off Komandorskie I., 18 May 1976; HUMZ 67312-67313, 67324-67325, 67327, 67331-67332, 67335, 67337, 67339, 67344, 67346 and 67349, 54°38'N, 165°44'W, 350-362 m, off Unalaska I., 16 June 1977; HUMZ 67428-67429 and 67431, 52°10'N, 179°53'W, 120-121 m, Aleutian Is., 22 June 1977; HUMZ 67765, 52°28'N, 172°58'E, 162-180 m, Aleutian Is., 5 June 1977; HUMZ 68075, 51°27'N, 179°53'W, 175-220 m, Aleutian Is., 7 June 1977; HUMZ 68253, 54°54'N, 165°37'W, 133-135 m, 16 June 1977; HUMZ 68345-68347, 51°38'N, 175°43'E, 150-157 m, Aleutian Is., 6 June 1977; HUMZ 76649, 58°07'N, 173°45'W, 117 m, Bering Sea, 12 July 1978; HUMZ 76746, 58°53'N, 173°15'W, 110 m, Bering Sea, 15 June 1978; HUMZ 77074, 56°18'N, 164°17'W, 87 m, Bering Sea, 7 May 1978; HUMZ 77244, 56°22'N, 171°15'W, 148 m, Bering Sea, 15 July 1978.

Leptagonus leptorhynchus (Gilbert, 1896)

(Japanese name: Tengu-tokubire)

Fig. 15.

Odontopyxis leptorhynchus Gilbert, 1896, p. 437 (original description; type locality, both sides of Alaskan Peninsula).

Sarritor leptorhynchus. Jordan and Evermann, 1896, p. 448 (listed).

Sarritor leptorhynchus leptorhynchus. Andriashev, 1937, p. 315 (short description).

Sarritor leptorhynchus knipowitschi Andriashev, 1937, p. 315 (description; compared with *Sarritor leptorhynchus leptorhynchus*).

Diagnosis. See differences in key to the species of the genus *Leptagonus*.

Counts. D. VI-IX-6-8; A. 6-8; P1. 13-15; P2. I, 2; C. 6+5; Br. 6; V. 43-45; LLP. 20-33; PP. 5-6; MDR. 14-19; DLR. 23-26; SLR. 35-42; ILR. 39-43; VLR. 20-24; MVR. 14-20.

Proportional measurements. Head 3.8-4.5 in SL; predorsal 3.0-3.4; pectoral fin 4.4-6.0; pelvic fin 10.8-22.0; caudal fin 7.5-10.0. Snout 2.3-3.0 in HL; orbit diameter 3.4-4.3; interorbital width 4.5-10.8; dorsal fin 2.8-3.9; anal fin 2.2-3.5. Body width 0.7-0.9 in its depth. Width of caudal peduncle 0.7-1.1 in its depth. Pelvic-anus length 4.3-8.7 in pelvic-anal length.

Body slender, depressed. Head depressed, triangular in dorsal view. Nasal bone with a recurved spine posterodorsally, attached to each other. Nasal tube very short, never reaching upper jaw. Snout pointed, far beyond upper jaw, with a pair of barbels on ventral surface. Irregular tiny tubercles on ventral surface of projecting snout. Supraocular and parietal spines sharp, recurved posterodorsally. Temporal ridge distinct, ending as a large posttemporal spine. Mouth small, lower jaw including in upper one. Maxillary with four barbels, reaching anterior margin of

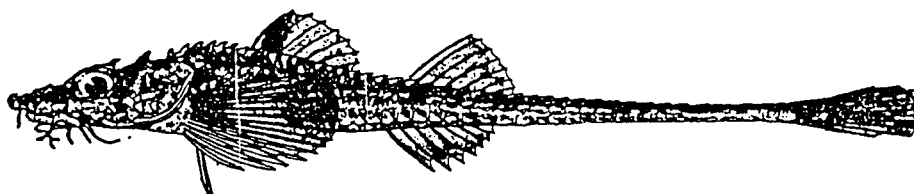

Fig. 15. *Leptagonus leptorhynchus* (Gilbert). Taken from Ueno, 1971.

orbit. Barbel on dentary short, divided distally. Eye moderate in size, with bony tubercles on its upper part. Interorbital narrow, concave, with a distinct frontal ridge. Infraorbital ridge with three spines, two on lachrymal, one on second infraorbital. Free lachrymal margin with two spines recurved posteroventrally. Preopercular spines three, upper two sharp and large, lowermost blunt and small. Gill membranes united, fused with isthmus, with a very narrow free margin.

Dorsal fins two, well separated. Interdorsal distance variable, 4.1-29.5 in HL. First dorsal fin originating at sixth or seventh plates of dorsolateral row. Anal origin below interdorsal space, far behind of anus. Pectoral fin sublateral, never reaching anal origin. Pelvic fin short, slender. Caudal fin small, round. Anus slightly posterior to pelvic base, far forward of anal origin.

Spine on dorsolateral, supralateral, infralateral and ventrolateral plates sharp anteriorly, reduced to a knob posteriorly. Plates of middorsal and midventral rows smooth, without spine. Lateral line plate small, tubular, anterior ones with or lacking a spine. Breast entirely covered with nonspinous plates. Infraorbital plates variable in size and number, 2-12. Gular region and united gill membrane covered with small nonspinous plates.

Color. When fresh, body brown, whitish ventrally, with seven indistinct cross bands and irregular blotches. Head brown dorsally, lighter ventrally. A dark brown streak running from snout tip to anterior margin of orbit. Upper margin of eye ball dark brown. Dorsal, anal and pelvic fins white. First dorsal fin with two dark brown bands, one on marginal part, one on basal part. Second dorsal fin with brown or dark brown spots. Pectoral fin brown with dark brown spots, white on lower lobe. Caudal fin uniformly dark brown. A dark brown blotch at corner of preopercular ridge. Mouth and peritoneum white. Gill cavity white with dark pigments.

Sexual dimorphism. Pelvic fin longer in male (10.3-13.0 in SL) than those in female (11.4-22.0).

Distribution. Japan Sea, south to Wansum and Oki I.; North Pacific Ocean from off Numazu of Shizuoka Prefecture, through Aleutian Is., to Gulf of Alaska; Okhotsk Sea; Bering Sea.

Remarks. *Leptagonus leptorhynchus* was divided by Andriashev (1937) into two subspecies, *L. l. leptorhynchus* and *L. l. knipowitschi*, without description. Subsequently, Taranetz (1937) proposed differences in the interorbital width and a notch in the anterior margin of the orbit between these two subspecies in his key. Kuronuma (1943) noted that the interorbital width was not useful for division of *L. leptorhynchus* into two subspecies, because the interorbital width of specimens from Horomushir Island indicated an intermediate condition (16.4-18.2% of HL) between the two subspecies. Lindberg and Andriashev (1950) stated that *L. l. leptorhynchus* was distributed in the northern Okhotsk and Bering Seas, whereas *L. l. knipowitschi* was confined to the Japan Sea. A comparison of specimens from these regions (Japan Sea, Pacific coast of northern Japan, Okhotsk Sea, and Kamchatka and Bering Sea), showed to be no differences between the specimens (Table 3). Accordingly, *L. l. knipowitschi* is considered to be a junior synonym of *L. leptorhynchus*.

L. leptorhynchus is easily distinguished from other species of *Leptagonus* by having a smooth free nasal margin, a spine on the second infraorbital without a

Table 3. Comparison of specimens of *Leptagonus leptorhynchus* among Japan Sea, Pacific coast of northern Japan, Okhotsk Sea, and Kamchatka and Bering regions.

	Japan Sea region	Pacific coast of northern Japan region	Okhotsk Sea region	Kamchatka and Bering regions
Number of specimens	12	25	3	8
Standard length (mm)	96.4-171.0	60.0-177.6	106.2-156.2	114.0-199.6
Counts :				
Dorsal fin rays	VI-IX-6-7	VI-IX-6-8	VIII-6-7	VI-IX-6-7
Anal fin rays	6-8	6-8	6-7	6-8
Pectoral fin rays	13-15	13-14	14	13-15
Vertebrae	43-44	43-45	43-44	43-44
Lateral line plates	20-31	25-33	27-29	25-31
Predorsal plates	5-6	5-6	5	5-6
Middorsal plates	15-17	14-19	17-18	14-18
Dorsolateral plates	24-26	23-26	24-25	24-26
Supralateral plates	35-38	35-39	42	35-42
Infralateral plates	40-42	40-43	41-42	39-42
Ventrolateral plates	20-23	20-24	22	21-23
Midventral plates	14-19	16-20	18	16-18
Proportional measurements :				
In standard length				
Head length	3.9-4.4	4.0-4.7	3.8-4.4	3.9-4.3
Predorsal length	3.0-3.4	3.0-3.4	3.0-3.4	3.1-3.3
Pectoral fin length	4.4-6.0	5.1-6.0	4.4-5.6	4.9-5.7
Pelvic fin length	11.4-21.9	10.8-20.9	10.8-22.0	11.3-21.0
Caudal fin length	7.5-9.3	7.9-10.0	7.9-8.6	8.0-9.0
In head length				
Orbit diameter	3.7-4.2	3.4-4.0	3.7-4.0	3.7-4.3
Interorbital width	5.2-10.8	4.5-7.1	4.8-6.9	5.1-6.6
Length from snout tip to upper lip in snout length	7.7-12.5	5.9-13.6	8.0-8.8	6.1-7.5
A notch of anterior margin of orbit	present or absent	present or absent	present or absent	present or absent

supplementary spine or knob, and less developed spines on the body plates.

L. leptorhynchus is common in northern Japan, living on the sandy or muddy sand bottoms in 50-200 m. It probably feeds on crustaceans and polychaets, as do other species in the genus.

Materials. 48 specimens, 60.0-199.6 mm SL. HUMZ 46051-46053, 42°53'N, 144°18'E, depth 180 m, off Kushiro, 15 July 1975; HUMZ 51508 and 51517, 42°05'N, 143°44'E, 345 m, off Hiroo, 25 March 1976; HUMZ 51607 and 51610, 42°01'N, 143°43'E, 323 m, off Hiroo, 25

March 1976; HUMZ 51930, off Niigata, 1966; HUMZ 51936, Toyama Bay; HUMZ 51937-51944, off Awa Island, Niigata Pref., March 1976; HUMZ 52011, off Fukui Pref., 16 September 1924; HUMZ 53363, 42°32'N, 143°48'E, off Kushiro, 6 September 1975; HUMZ 53413, 42°32'N, 143°51'E, off Kushiro, 6 September 1975; HUMZ 54094, 52°05'N, 155°47'E, 79-80 m, off western coast of Kamchatka, 29 May 1976; HUMZ 54134, 52°01'N, 155°31'E, 175-180 m, off western coast of Kamchatka, 29 May 1976; HUMZ 54263 and 54264, 61°27'N, 174°30'E, 60-65 m, Bulchta Bay, 26 July 1976; HUMZ 55320, 54°16'N, 160°57'E, 125-300 m, off eastern coast of Kamchatka, 20 May 1976; HUMZ 56318, 53°56'N, 160°26'E, 215-240 m, off eastern coast of Kamchatka, 20 May 1976; HUMZ 64772, off Kamo, Yamagata Pref., 100-300 m, 6 April 1978; HUMZ 67640, 43°11'N, 145°49'E, 76 m, off Nemuro Peninsula, 23 May 1977; HUMZ 67461, 43°11'N, 145°48'E, 73 m, off Nemuro Peninsula, 3 July 1977; HUMZ 69189, 42°21'N, 143°45'E, 196 m, off Hiroo, 8 September 1977; HUMZ 75986 and 75987, 42°52'N, 144°19'E, 180 m, off Kushiro, 14 July 1978; HUMZ 76034, 45°18'N, 142°52'E, 120-122 m, off Hamatonbetsu, 4 October 1977; HUMZ 77519, off Shiranuka, Aomori Pref., 240 m, 26 September 1978; HUMZ 77931 and 77932, off Okoppe, Okhotsk coast of Hokkaido, 95 m, 29 August 1978; HUMZ 87920 and 88905, 52°06'N, 175°27'W, 90 m, Atka Pass, 13 July 1980; HUMZ 90656-90665, Miyako fish market, 23 April 1981.

Genus *Podothecus* Gill, 1862

Podothecus Gill, 1862b, p. 77 (type, *Podothecus peristethus* Gill).

Paragonus Gill, 1862c, p. 167 (type, *Agonus acipenserinus* Tilesius).

Paragonus Guichenot, 1869, pp. 201-202 (not of Gill; type, *Paragonus sturiooides* Guichenot).

Draciscus Jordan and Snyder, 1901, p. 379 (type, *Draciscus sachi* Jordan et Snyder).

External diagnosis. *Podothecus* is distinguished from other genera of the family Agonidae in having the following characters: two dorsal fins; no barbel on snout tip; short nasal tube never reaching upper jaw; nasal bones attached to each other anteriorly; no rostral plate; nasal bone projecting forward beyond upper jaw; two nasal spines, one directed anteriorly, one recurved posterodorsally; a pair of ethmoidal spines; a parietal spine; two or three patches of barbels on ventral surface of snout; maxillary with a patch of barbels; no barbels on lower jaw tip; gill membranes united, widely fused with isthmus; six branchiostegal rays; no occipital pit; 7-10 dorsal spines; 7-17 anal fin rays; 3-5 predorsal plates; supralateral plates; breast covered with bony plates.

Internal diagnosis. *Podothecus* differs from other genera of Agonidae in possessing the following osteological characters: lachrymal with a median shelf; ascending process of premaxillary shorter than alveolar process; interhyal shorter than epihyal; plate-like urohyal; no basihyal; three basibranchials; exoccipital never exposed; no tabular bone; three actinosts on pectoral girdle; two postcleithra; absence of postpelvic spine; no pleural bone; first dorsal proximal radial into third or fourth space between fourth and fifth neural spines, supporting one spine; interneural spines continuously inserted into each interneural space between separated dorsals; one epural.

Remarks. This genus is closely similar to *Freemanichthys* in having two or three patches of barbels on the ventral surface of the snout, the nasal bone projecting forward beyond the upper jaw, a patch of barbels on the maxillary and an ethmoidal spine. It is easily distinguished from the latter by having a pair of ethmoidal spines and a forwardly projecting spine on the nasal, and lacking a rostral plate on the ventral surface of the snout. The genus also resembles *Agonus* and *Leptagonus*, in

having a forwardly projecting nasal bone beyond the upper jaw, and lacking an enlarged rostral plate and so on. It differs from *Agonus* in having patches of barbels on the ventral surface of the snout and maxillary, a pair of ethmoidal spines and a spine on the parietal. It is distinguished from *Leptagonus* by having a forwardly projecting nasal spine and patches of barbels present on the ventral surface of the snout and maxillary.

Podothecus is represented by five species, *P. acipenserinus*, *P. veterinus*, *P. hamlini*, *P. sturioides* and *P. sachi*.

Key to the species of *Podothecus*

- 1a. Two patches of barbels on ventral surface of snout. 2.
- 1b. Three patches of barbels on ventral surface of snout. 4.
- 2a. A patch of barbels on snout numbering 13-19. Uppermost preopercular spine not expanded laterally. *P. acipenserinus*
- 2b. A patch of barbels on snout numbering 6-11. Uppermost preopercular spine expanded laterally. 3.
- 3a. No tubercles on eye ball. Dorsolateral plates 21-22. Ventrolateral plates 19-20. Caudal peduncle smooth. *P. veterinus*
- 3b. Tubercles on eye ball. Dorsolateral plates 24-25. Ventrolateral plates 23. Caudal peduncle spinous. *P. hamlini*
- 4a. Second dorsal fin rays 10 or less. Anal fin rays 11 or less. Ventrolateral plates 21 or less. *P. sturioides*
- 4b. Second dorsal fin rays 11 or more. Anal fin rays 13 or more. Ventrolateral plates 24 or more. *P. sachi*

Podothecus acipenserinus (Tilesius, 1813)

(Japanese name: Kitano-tokubire)

Fig. 16.

Agonus acipenserinus Tilesius, 1813, p. 422, pl. 11, fig. 163 (original description; type locality, Unalaska)

Phalangistes acipenserinus. Tilesius, 1814, p. 110 (description).

Aspidophorus acipenserinus. Cuvier in Cuvier and Valenciennes, 1829, p. 207 (description).

Cottus aspidophorus acipenserinus. Richardson, 1836, p. 49 (few diagnostic characters).

Paragonus acipenserinus. Gill, 1862c, p. 167 (listed).

Podothecus peristesus Gill, 1862d, pp. 259-261 (description; locality, Simeamoo).

Podothecus acipenserinus. Jordan and Gilbert, 1881c, p. 454 (listed; locality, Puget Sound).

Diagnosis. In addition to the characters in the key, *P. acipenserinus* is distinguished from other species of *Podothecus* in having the following characters: no tubercles on eye ball; 7-8 second dorsal fin rays; 7-9 anal fin rays; 21-24 dorsolateral plates; 20-22 ventrolateral plates; smooth caudal peduncle.

Counts. D. VIII-X-7-8; A. 7-9; P1. 17-19; P2. I, 2; C. 6+5; Br. 6; V. 40-42; LLP. 38-40; PP. 3-4; MDR. 13-16; DLR. 21-24; SLR. 28-31; ILR. 36-38; VLR. 20-22; MVR. 14-16.

Proportional measurements. Head 3.5-3.8 in SL; predorsal 3.0-3.2; pectoral fin 4.6-5.5; pelvic fin 8.8-18.5; caudal fin 7.7-8.7. Snout 2.1-2.2 in HL; orbit diameter 4.4-5.0; interorbital width 3.8-4.4; dorsal fin 2.4-3.0; anal fin 1.9-2.5.

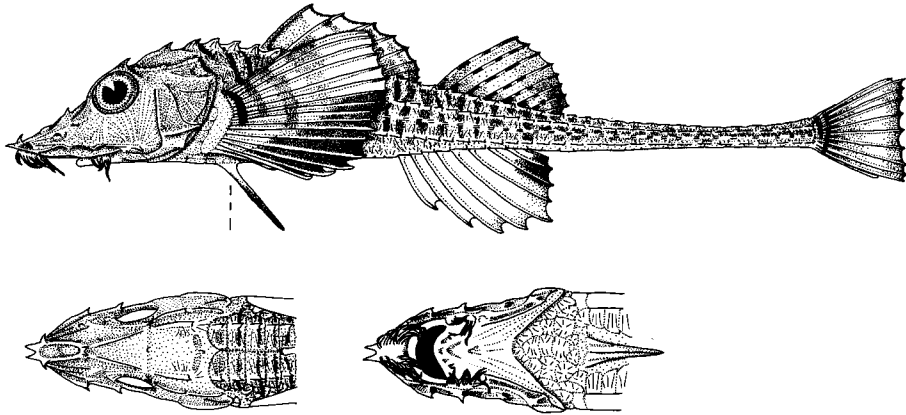

Fig. 16. *Podotheucus acipenserinus* (Tilesius): HUMZ 76797, 193.4 mm SL.

Body width 0.9-1.1 in its depth. Width of caudal peduncle 0.7-1.0 in its depth. Pelvic-anus length 7.8-17.7 in pelvic-anal length.

Body elongate, highest at just behind head, tapering to caudal peduncle. Head moderate in size, pointed. Nasal bone with a forward and an upturned spine, attached to each other anteriorly. Posterior nasal tube short on center of snout, lateral side of midline. Snout long, flat. Ventral surface of snout with a pair of patches of barbels, without a rostral plate and bony tubercles. Ventral snout barbel 13-19. A pair of ethmoidal spines on midline of snout. Supraocular spine small, sharp. Frontal-parietal ridge distinct, gradually higher to posterior, ending as a large parietal spine, without a supplementary spine. Temporal ridge distinct, with 3-4 spines, one at upper posterior corner of orbit, one or two on pterotic, one on posttemporal. Eye moderate in size, without bony tubercles. Infraorbital ridge with three spines, one on lachrymal, one on first infraorbital, and one on second infraorbital with a supplementary knob or lacking. Cheeks almost entirely covered with expanded second infraorbital. Free lachrymal and first infraorbital margin serrated. A small knob on lachrymal between infraorbital ridge and posterior nasal tube. Mouth inferior, lower jaw never reaching upper one. Maxillary reaching anterior margin of orbit. Maxillary barbels 13-18. Two short barbels on center of lower jaw. Preopercular spines four, uppermost with a low keel, large, directed posteriorly, other three small and blunt. A ridge on opercle low, ending as a spine. Neither cirri nor barbels on gular and gill membranes. Gill membrane united, joined to isthmus, without free fold. A row of teeth on upper jaw. Teeth in bands on lower jaw, no teeth on prevomer and palatine.

Dorsal fins two, separated. Interdorsal distance variable, 12.4-92.6 in HL. First dorsal fin originating level with fourth to fifth dorsolateral plates. Anal origin below posterior part of dorsal fin. Pectoral fin sublateral, never reaching anal origin. Pelvic fin short, slender. Caudal fin truncate, lower lobe slightly elongate. Anus just behind pelvic base.

Plates of dorsolateral, middorsal, supralateral, infralateral, ventrolateral,

midventral and lateral line rows, present. Dorsolateral plates with a sharp spine anteriorly, a blunt spine posteriorly. Middorsal plates with a blunt spine anteriorly, lacking a spine posteriorly. A sharp spine on plates of supralateral and infralateral rows present anteriorly, gradually reduced to a knob on posterior caudal peduncle. Ventrolateral plates with a tiny spine or lacking. Midventral plates smooth, lacking a spine. Breast entirely covered with nonspinous prepelvic plates. Space between anus and anal origin with small plates. Subpectoral plates 3-5, first two or three with a spine. Lateral line plates tubular, smooth, first 8-10 plates enlarged, with a sharp spine.

Color. In preserved specimens, body brown, with dark irregular vertical streaks. Dorsal fins pale. First dorsal with dark margin and a dark band. Second dorsal darker dorsally. Anal fin pale, last two to five rays with dark distal. Pectoral fin pale, with four indistinct bands and a dark blotch at base of upper lobe, lower lobe dark. Caudal fin dark, with darker margin. Pelvic fin pale or dark. Mouth cavity pale. Gill cavity and peritoneum dark.

Sexual dimorphism. Pectoral, pelvic, dorsal and anal fins longer in male than those in female.

Distribution. Bering Sea to Eureka, California.

Remarks. *Podothecus acipenserinus* is most closely similar to *P. veternus* in having dark, irregular, vertical streaks on the body, two patches of barbels on the ventral surface of the snout and a smooth caudal peduncle, but differs in having 13-19 barbels in each patch on the ventral surface of the snout and the uppermost preopercular spine with a low keel. Furthermore, *P. acipenserinus* is widely distributed in the Bering Sea to California, but *P. veternus* is confined to the northern Okhotsk Sea and Peter the Great Bay.

Locally called sturgeon poacher, *P. acipenserinus*, is common along the entire coast of British Columbia where it is taken abundantly between 18-55 m (Hart, 1973). In the Bering sea, it is frequently taken by otter trawl from the bottom in 50-300 m. The species feeds on crustaceans and marine worms.

Materials. 35 specimens, 116.1-264.0 mm SL. HUMZ 6971, Bering Sea; HUMZ 7801, 56°36'N, 153°17'W, depth 147-151 m, Gulf of Alaska, 6 May 1964; HUMZ 17439-17444, Strait of Georgia, B.C. Canada, September 1956; HUMZ 20090, 58°32'N, 167°25'W, 1 July 1964; HUMZ 20607, 55°46'N, 164°00'W, 96 m, Bristol Bay, 10 July 1965; HUMZ 22122, 57°22'N, 168°17'W, 75 m, Bering Sea, 3 June 1966; HUMZ 22141, 22142, 22202, 22226, 59°22'N, 168°17'W, 75 m, SW of Nunivak, Bristol Bay, 3 June 1966; HUMZ 55314, 55318, 55323, 55325, 55326, 55358, 54°16'N, 160°57'E, 125-300 m, eastern Kamchatka, 20 May 1976; HUMZ 67425, 52°10'N, 179°53'W, 120-121 m, 22 June 1977; HUMZ 67907, 67908, 52°57'N, 168°00'W, 119-122 m, Off Pacific coast of Unalaska I., 10 June 1977; HUMZ 76248, 57°06'N, 166°46'W, 72-73 m, Bering Sea; 30 May 1978; HUMZ 76797, 57°17'N, 160°18'W, 52 m, Bering Sea, 23 May 1978; HUMZ 76881, 57°05'N, 162°46'W, 59 m, 23 May 1978; HUMZ 76894, 76895, 76897, 57°19'N, 163°21'W, 52 m, Bering Sea, 22 May 1978; HUMZ 75977, 76980, 76981, 57°35'N, 164°47'W, 60-61 m, Bering Sea, 29 May 1978; HUMZ 76991, 57°34'N, 163°42'W, 50 m, Bering Sea, 26 May 1978; HUMZ 77303, 55°04'N, 164°46'W, 77-80 m, Bering Sea, 5 May 1978.

Podothecus veternus Jordan et Starks, 1895

(Japanese name: Onaga-tokubire)

Fig. 17.

Podothecus veternus Jordan and Starks, 1895, pp. 819-821, pl. 89 (original description; type locality, Robben I.).

Agonus veternus. Schmidt, 1936, pp. 58-59 (change of generic name; relationship).

Diagnosis. In addition to the characters in the key, *P. veternus* is distinguished from other species of *Podothecus* in having the following characters: 7 second dorsal fin rays; 8-9 anal fin rays.

Counts. D. VIII-IX-7; A. 8-9; P1. 16-17; P2. I, 2; C. 6+5; Br. 6; V. 38-42; LLP. 37-42; PP. 3-4; MLR. 13-16; DLR. 21-22; SLR. 28-31; ILR. 34-38; VLR. 19-20; MVR. 14-17.

Proportional measurements. Head 3.5-3.9 in SL; predorsal 2.8-3.0; pectoral fin 4.3-5.0; pelvic fin 8.8-20.5; caudal fin 7.0-8.1. Snout 2.1-2.3 in HL; orbit diameter 3.9-4.3; interorbital width 4.0-4.8; dorsal fin 2.7-3.0; anal fin 2.0-2.7. Body width 0.9-1.1 in its depth. Width of caudal peduncle 0.7-1.0 in its depth. Pelvic-anus length 8.9-20.9 in pelvic-anal length.

Body slender, highest at predorsal region, tapering to caudal peduncle. Caudal peduncle smooth, somewhat depressed. Head moderate in size, pointed. Nasal spines two, one directed forward, one recurved posterodorsally. Nasal tube short, never reaching upper jaw. Snout elongate, triangular in lateral view. A pair of patches of barbels on under surface of snout (7-11). A pair of spines on midline of ethmoid. Supraocular spine small, sharp. Frontal-parietal ridge ending as a large parietal spine. Temporal ridge distinct, finely serrated, ending as a small post-temporal spine. Spines on temporal ridge variable, 0-3. Eye moderate in size, without tubercles. Infraorbital ridge with three spines, one on lachrymal, one on

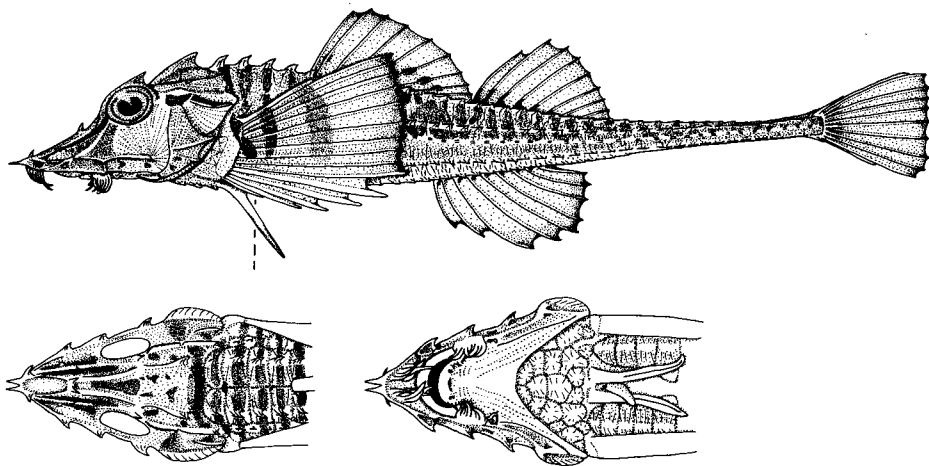

Fig. 17. *Podothecus veternus* Jordan et Starks: HUMZ 58950, 138.2 mm SL.

first infraorbital, and one on second infraorbital without supplementary knob. Cheeks almost completely covered with expanded second infraorbital. Free lachrymal and first infraorbital margins serrated. A small spine on lachrymal above infraorbital ridge. Mouth inferior, lower jaw lip far behind upper one. Maxillary with 10-14 barbels at posterior end, reaching anterior margin of orbit. Two short barbels on lower jaw. Gular and gill membranes without cirri and barbels. Gill membranes united, fused to isthmus, without free fold. Preopercular spines four, uppermost one large, strongly expanded laterally, second one small, directed ventroposteriorly, other two indistinct. One or two rows of small teeth on lower jaw, no teeth on upper jaw, prevomer and palatine.

Dorsal fins two, separated or connected by fin membrane. First dorsal fin originating at fourth or fifth dorsolateral plates. Anal origin below posterior end of first dorsal fin. Pectoral fin never reaching anal origin. Caudal fin moderate in size, truncate. Anus just behind pelvic fin base.

Body entirely covered with enlarged plates. Dorsolateral plates with a sharp spine anteriorly, a blunt spine posteriorly. Spines on plates of anterior middorsal row blunt, gradually reduced to an indistinct knob posteriorly. A sharp spine on plates of supralateral and infralateral rows present anteriorly, gradually reduced to a knob on posterior caudal peduncle. Ventrolateral plates with a tiny spine or lacking. Midventral plates smooth, without spines. Breast completely covered with plates. Space between anus and anal origin with some small plates. Subpectoral plates 3-6, with a spine or lacking. Lateral line plates tubular, smooth, first 7-10 plates with a spine.

Color. In preserved specimens, body brown, with dark irregular vertical streaks. Head darker dorsally, paler ventrally. A transverse streak on lateral side of snout and interorbital region. First and second dorsal fins with dark margin and a dark band basally. Pectoral fin pale, with indistinct dark bands and a spot on upper lobe. Caudal fin dark.

Sexual dimorphism. Anal fin pale, with dark margin in male, without in female. Pelvic fin dark in male, pale in female. Pelvic fin longer in male (7.9-10.0 in SL) than those in female (13.8-20.5).

Distribution. Peter the Great Bay; Robben Island of Sakhalin; northern Okhotsk Sea.

Remarks. In his comparison of *Podothecus veterinus* with *Freemanichthys thompsoni* (= *Podothecus thompsoni*), Schmidt (1950) mentioned that the species was actually a cold water subspecies of the latter. But *P. veterinus* is far from *F. thompsoni* in having no rostral plate, a pair of ethmoidal spines, no serrated nasal margin, irregular vertical streaks on body, etc. These differences indicate that *P. veterinus* and *F. thompsoni* are independent species. *P. veterinus*, in fact, resembles *P. acipenserinus*, but differs in having 7-11 barbels on the ventral surface of the snout and a well expanded lateral keel on the uppermost preopercular spine.

P. veterinus is common in the northern Okhotsk Sea, and is replaced by *P. acipenserinus* in the Bering Sea. It is taken from the bottom by otter trawl in 38-240 m.

Materials. 28 specimens, 122.0-229.7 mm SL. HUMZ 46305, 46308, 50°28'N, 156°45'E, depth 100-103 m, off Paramushir I., 23 June 1975; HUMZ 57966-57968, 57970, 57973, 57974,

55°32'N, 138°08'E, 85 m, off Shantar Is., 7 September, 1976; HUMZ 58912-58914, 58916-58920, 58923, 58924, 58945, 58947-58950, 58952-58954, 58957, 54°08'N, 141°15'E, 38 m, off Ayan, 21 September 1976; HUMZ 60383, 56°37'N, 143°35'E, 240 m, off Okhotsk, 22 September 1976; HUMZ 60671, 54°34'N, 140°53'E, 85 m, off Shantar Is., 18 October 1976.

Podothecus hamlini Jordan et Gilbert, 1898

(Japanese name: Chishima-tokubire)

Fig. 18.

Podothecus hamlini Jordan and Gilbert in Jordan and Evermann, 1898, pp. 2054 and 2056-2058 (original description; type locality, Shana Bay of Iturup I.)

Diagnosis. In addition to the characters in the key, *P. hamlini* is distinguished from other species of *Podothecus* in having the following characters: 6-8 dorsal fin rays; 8-10 anal fin rays.

Counts. D. VIII-IX-8; A. 10; P1. 15-16; P2. I, 2; C. 6+5; Br. 6; V. 40-41; LLP. 39-40; PP. 4; MDR. 13-14; DLR. 23-25; SLR. 32; ILR. 37; VLR. 23; MVR. 14-16.

Proportional measurements. Head 3.2-3.4 in SL; predorsal 2.7-2.8; pectoral fin 5.5-5.8; pelvic fin 9.5-10.2; caudal fin 7.8-8.3. Snout 2.0-2.1 in HL; orbit diameter 4.5-4.7; interorbital width 4.8-5.3; dorsal fin 2.9-3.2; anal fin 3.6-4.0. Body width 0.9 in its depth. Width of caudal peduncle 0.8-0.9 in its depth. Pelvic-anus length 9.5-11.9 in pelvic-anal length.

Body slender, slightly depressed, tapering to caudal peduncle. Head slightly depressed, pointed. Snout prolonged, far beyond upper jaw. A pair of patches of barbels on ventral surface of snout, never continuous with each other at anterior end, number of barbels in each patch 6-7. Nasal bone with a forwardly projecting spine and an upturned spine. Nasal tube very short, never reaching upper jaw. A pair of spines on mid-ethmoid. A spine on supraocular and parietal. Temporal ridge

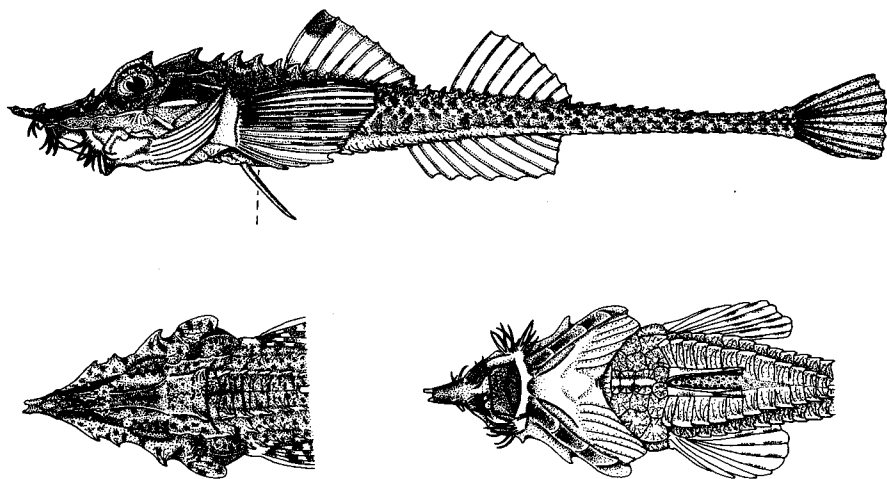

Fig. 18. *Podothecus hamlini* Jordan et Gilbert: HUMZ 86872, 109.4 mm SL.

finely serrated. Eye moderate in size, with a row of bony knobs on upper part. Infraorbital ridge with three large spines. A spine on lachrymal between infraorbital ridge and orbit. Mouth inferior, lower jaw far behind upper one. Maxillary reaching slightly before anterior margin of orbit, with 13 barbels. Lower jaw with two barbels at middle of dentary. Preopercular spines four, uppermost with a well laterally expanded keel, large, other three small. No cirri nor barbels on gular region and gill membranes. Gill membranes united, joined to isthmus without free fold. Teeth on jaws, no teeth on prevomer and palatine.

Dorsal fins two, separated in short distance. First dorsal fin originating fairly late on head, at fifth plate of dorsolateral row. Anal fin originating at middle of body, just below posterior end of first dorsal fin. Pectoral fin sublateral, never reaching anal origin. Pelvic fin small, short, just below of pectoral fin base. Caudal fin moderate in size, truncate. Anus far forward of anal origin, just behind pelvic fin base.

A well developed spine on plates of middorsal, dorsolateral, supralateral, and infralateral rows. Plates of ventrolateral row, with a well developed sharp spine anteriorly, blunt posteriorly. Midventral plates smooth. A blunt spine on breast plates. First seven plates of lateral line with a well developed spine, other plates smooth, without spine. Subpectoral plate 5-6, with a spine. Head coarsely covered with bony tubercles and small spinous plates. An infraorbital plate with a spine. No plates on gular, united membrane. Small plates surrounding anus.

Color. In preserved specimens, body brown, darker above, paler below. Many darker dashes on back. Nuchal region with two narrow cross bands. A dark streak from eye to tip of snout. Dorsal fin pale with dark spots. A large spot at upper anterior corner of first dorsal. Pectoral fin with a dark spots on base of upper lobe, upper lobe dusky, lower lobe pale. Pelvic and anal fins pale. Caudal fin dark, with pale spots. Mouth and gill cavities dark. Peritoneum pale.

Sexual dimorphism. Not examined.

Distribution. Off mouth of Oomu River, Okhotsk coast of Hokkaido; Shana Bay, Iturup I.

Remarks. Schmidt (1904) considered that *Podothecus hamlini* was a synonym of *P. gilberti*. Schmidt's view has been accepted by many workers (Soldatov and Lindberg, 1930; Schmidt, 1936, 1950; Matsubara, 1955; Ueno, 1967 etc.). However, the validity of *P. hamlini* was confirmed by Kanayama (1991). The paralectotype examined and two additional specimens agree well with the original description of *P. hamlini*, and are easily distinguishable from *P. gilberti* (= *P. sturionides* = *P. accipiter*) in having a pair of patches of barbels on the ventral surface of the snout and an uppermost preopercular spine with a keel well expanded laterally. Thus, *P. hamlini* is a well differentiated species.

P. hamlini is rare, being known only from off the Oomu River, Okhotsk coast of Hokkaido, and Shana Bay, Iturup I.

Materials. 3 specimens, 90.5-109.4 mm SL. CAS-SU 5662, paralectotype, off Shana Bay, Iturup I., 6 September 1896; HUMZ 86872-86873, off Mouth of Oomu River, Okhotsk coast of Hokkaido, depth 55 m, 3 May 1979.

Podothebus sturioides (Guichenot, 1869)
(Japanese name; Same-tokubire)

Fig. 19.

Paragonus sturioides Guichenot, 1869, pp. 202-204, pl. 12, fig. 3 (original description; type locality, China).

Agonus sturioides. Day, 1881, p. 67 (mentioned in text).

Agonus gilberti Collett, 1894, pp. 670-675, pl. 45 (original description; locality, Kamchatka).

Podothebus gilberti. Jordan and Starks, 1895, p. 821 (mentioned in text).

Podothebus accipiter Jordan and Starks, 1895, pp. 816-819, pl. 88 (description; locality, Robben I.).

Podothebus sturioides. Jordan and Evermann, 1898, p. 2063 (translation of original description by Guichenot, 1869).

Diagnosis. In addition to the characters in the key, *P. sturioides* is distinguished from other species of *Podothebus* in having the following characters: no bony tubercles on eye ball; preopercular spine not expanded laterally; spinous caudal peduncle; 21-24 dorsolateral plates.

Counts. D. VII-IX-7-9; A. 8-11; P1. 15-17; P2. I, 2; C. 6+5; Br. 6; V. 37-40; LLP. 36-40; PP. 3-5; MDR. 12-16; DLR. 21-24; SLR. 28-31; LLR. 34-36; VLR. 19-21; MVR. 14-17.

Proportional measurements. Head 3.2-3.9 in SL; predorsal 2.6-3.1; pectoral fin 4.2-5.2; pelvic fin 7.2-29.3; caudal fin 5.3-7.4. Snout 2.0-2.2 in HL; orbit diameter 3.8-4.7; interorbital width 4.3-4.9; dorsal fin 1.9-2.9; anal fin 1.5-2.7. Body width 1.0-1.2 in its depth. Width of caudal peduncle 1.0-1.3 in its depth. Pelvic-anus length 11.8-22.7 in pelvic-anal length.

Body elongate, slightly compressed. Head moderate in size, compressed. Nasal bone with two spines, one projecting forward, one upturned. Nasal bones attached to each other at anterior part. Nasal tube short, never reaching upper jaw. Snout prolonged, triangular in lateral view. Barbels on ventral surface of snout in three patches, one on anterior tip, two on each side just in front of upper jaw. A pair of ethmoidal spines in midline. Supraocular and parietal spines present. Frontal-parietal ridge finely serrated, slightly converged anteriorly. Temporal ridge serrated, ending as a small posttemporal spine. Eye moderate in size, without bony tubercles. Infraorbital ridge, finely serrated, ending as a small spine with a supplementary blunt spine. A sharp lachrymal spine above infraorbital ridge. Free lachrymal margin serrated, with tiny spines. Infraorbital bones well expanded, completely covering cheek region, attached to lower preopercular ridge. Mouth inferior, upper jaw never reaching lower one, its distance 5.1-7.1 in HL. Maxillary reaching slightly before anterior margin of orbit. A patch of maxillary barbels, numbering 10-17. Two short barbels on lower jaw. Preopercular spines two, uppermost spine with a low keel, large, lower one small. Neither cirri nor barbels on lower jaw and gill membranes. Gill membranes united to each other and joined to isthmus. Teeth on jaws, no teeth on prevomer and palatine.

Dorsal fins two, well separated. Interdorsal distance variable, 6.6-21.2 in HL. First dorsal fin originating at fourth to sixth dorsolateral plates. Anal origin just below end of first dorsal. Pectoral fin sublateral, may reach anal origin. Pelvic fin just below lower pectoral base. Anus situated pelvic fin base, slightly behind.

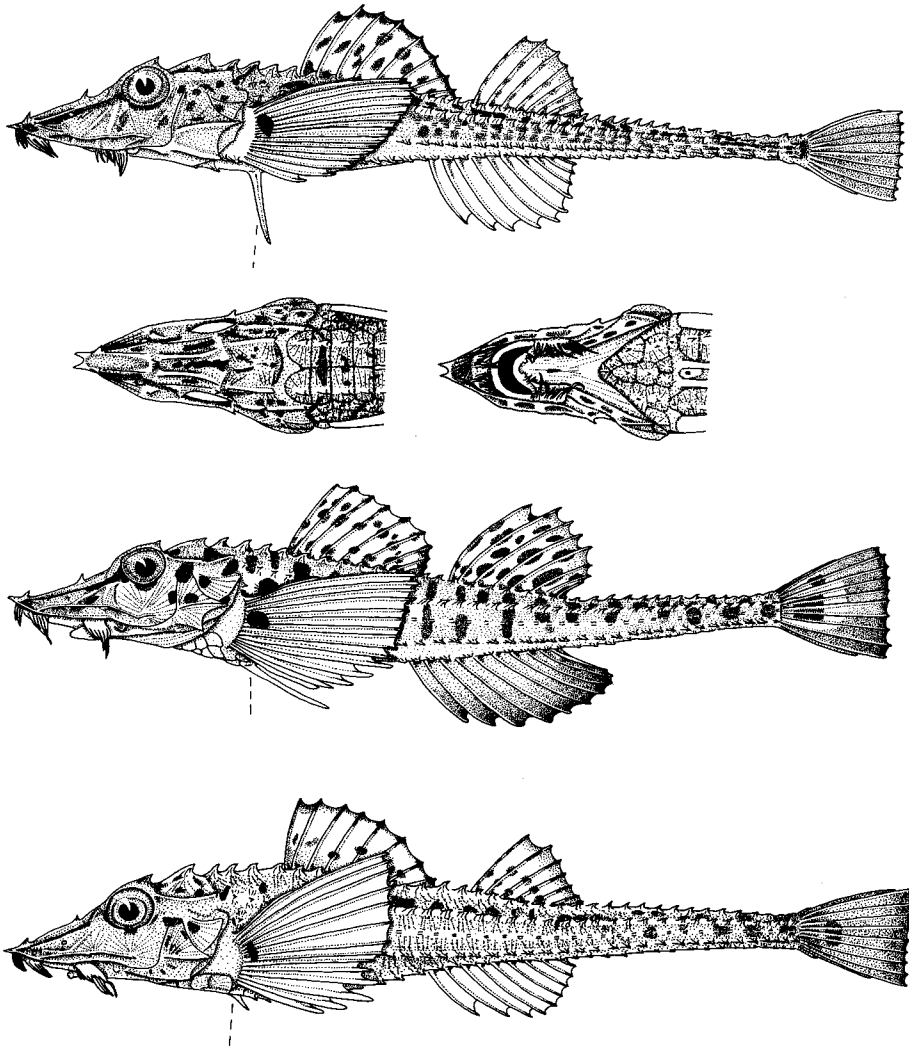

Fig. 19. *Podothecus sturionoides* (Guichenot) : top, young. middle, male. bottom, female.

Caudal fin moderate in size, truncate.

Plates of dorsolateral, middorsal, supralateral and infralateral rows, with a small sharp spine. Spines of ventrolateral plates sharp anteriorly, blunt posteriorly. Midventral plates with a tiny spine or lacking. Plates on breast with a tiny spine. Subpectoral plates 4-6, with a spine. An infraorbital plate one or absent. No plates on gill membrane and gular region. Head roughly covered with prickles.

Color. In preserved specimens, body brown, darker dorsally, paler ventrally. Head darker dorsally, paler ventrally. A dark streak from tip of snout to anterior margin of orbit. Small spots on postorbital region and dorsal surface of head. A

disjunct streak on midline of interorbital region. Anterior half of ventral surface of snout dark. Anterior patch of snout dark. Dorsal fin pale with dark spots. Pectoral fin pale, darker on upper lobe. A dark spot on base of upper pectoral fin. Caudal fin dark with a pale blotch on center. Mouth cavity pale. Gill cavity and peritoneum pale with pigments.

Sexual dimorphism. Upper half of body with dark spots in male, dark dashes and irregular blotches in female and young. Anal fin dark in male, pale in female and young. Pelvic fin pale, dark tip in male.

Pelvic fin in male longer (7.2-8.8 in SL) than those in female (22.4-29.3).

Distribution. Japan Sea, south to Kasumi, Japan and Wonsan, Korea; Pacific coast of Hokkaido; Okhotsk Sea; Avatcha Bay of eastern Kamchatka.

Remarks. *Podothecus sturiooides* was described by Guichenot (1869) on the basis of a single specimen from the China Sea (the type locality, China Sea, is doubtful, and should perhaps be the Japan Sea). Collett (1894) later described *P. gilberti*, under the name of *Agonus gilberti*, based on 12 specimens from Kamchatka. Following Collett's (1894) work, *P. accipiter* was described by Jordan and Starks (1895), on the basis of a single specimen from Robben Island, Sakhalin, and *P. hamlini* was added by Jordan and Gilbert (1899). Schmidt (1904) synonymized *P. hamlini* with *P. gilberti* and suggested the possibility that *P. accipiter* was a synonym of *P. gilberti*. However, Schmidt (1904) did not refer to *P. sturiooides*. Therefore, up until now, two species, *P. sturiooides* and *P. gilberti*, have been recognized. As discussed under *P. hamlini*, that species clearly differs from *P. sturiooides*, *P. gilberti* and *P. accipiter*, and is a well differentiated species. A comparison between four nominal species is made in Table 4, which shows that there are no differences between *P. sturiooides*, *P. gilberti* and *P. accipiter*. Part of the confusion of previous authors is clearly due to the differences in color pattern between male, female and young specimens. Male specimens have a large, dark spotted body and dark anal fin, whereas the female and young specimens have an irregularly marked body and pale anal fin (Fig. 19). Thus, it is concluded that *P. gilberti* and *P. accipiter* are junior synonyms of *P. sturiooides*.

P. sturiooides is common in the northern Japan, especially around Hokkaido, and is a bottom dweller at depths from 10 to 150 m.

Materials. 28 specimens, 140.5-259.5 mm SL. HUMZ 7374-7375, 7377 and 7379, off Western Kamchatka; HUMZ 19432, 42°30'N, 143°45'E, depth 97-140 m, off Ootsu, 30 March 1963; HUMZ 34017 and 34181, off Kushiro, 80 m, 19 July 1974; HUMZ 45013, 45°14'N, 143°22'E, 140-143 m, off Esashi, 30 June 1975; HUMZ 45403, 42°32'N, 143°48'E, 87 m, 6 September 1975; HUMZ 45714, 42°52'N, 144°36'E, 60 m, 16 July 1975; HUMZ 45913 and 45927, 42°54'N, 144°36'E, 40 m, 16 July 1975; HUMZ 47490, 42°32'N, 143°48'E, 87 m, 6 September 1975; HUMZ 53954-53955, 46°00'N, 142°32'E, 85 m, 2 June 1976; HUMZ 54083, 54085 and 54087, 52°05'N, 155°47'E, 79-80 m, western Kamchatka, 29 May 1976; HUMZ 54136, 52°01'N, 155°31'E, 175-180 m, western Kamchatka, 29 May 1976; HUMZ 54883, 53°01'N, 155°40'E, 53-55 m, western Kamchatka, 30 May 1976; HUMZ 60324-60325, 52°07'N, 155°38'E, 158 m, western Kamchatka, 9 October 1976; HUMZ 81196-81198 and 81200, off Akkeshi, Pacific coast of Hokkaido, 24 June 1979; HUMZ 81240-81241, off Akkeshi, 25 June 1979.

Table 4. Comparison of four nominal species of *Podothecus*, *P. sturioides*, *P. gilberti*, *P. accipiter* and *P. hamlini*.

	<i>sturioides</i>		<i>gilberti</i>	<i>accipiter</i>	<i>hamlini</i>	
	present specimens	Guichenot (1869) original description	Collett (1894) original description	Jordan and Starks (1895) original description	present specimens	Jordan and Gilbert (1899) original description
Number of specimens	28	1	10	1	2	3
Standard length (mm)	140.5-259.5	260.0	183.0-290.0	ca 240.0	90.5-109.4	153.0
Counts						
Dorsal spines	7-9	9	8	8	8-9	8-11
Dorsal rays	7-9	8	8-9	9	8	6-8
Anal rays	8-11	10	10-11	10	10	8-10
Pectoral rays	15-17	15	15-17	15	16	15
Lateral line plates	36-40	ca 38	38	36	39-40	40
Middorsal plates	12-16	14	13		13	
Dorsolateral plates	21-24	24	23		24-25	
Supralateral plates	28-31				32	
Infralateral plates	33-36		35		37	
Ventrolateral plates	19-21		21		23	24
Midventral plates	14-17		17		14-15	
Vertebrae	37-40				41	42
Maxillary barbels	10-17				13-14	14
Number of patches of snout barbels	3	3		3	2	2
Keel of preopercular spine	low	low	low	low	high	high

Podothecus sachi (Jordan et Snyder, 1901)
(Japanese name: Tokubire)

Fig. 20.

Draciscus sachi Jordan and Snyder, 1901, pp. 379-380, pl. 19 (original description; type locality, Aomori Bay).

Podothecus tokubire Ishikawa, 1904, pp. 2 and 15-17 (description; locality, Hokkaido).

Podothecus xystes Snyder, 1911, pp. 541-543 (description; locality, off Nagaoka).

Podothecus sachi. Tanaka, 1931, p. 46 (listed).

Diagnosis. In addition to the characters in the key, *P. sachi* is distinguished from other species of *Podothecus* in having the following characters: no tubercles on eye ball; uppermost preopercular spine not expanded laterally; 26-28 dorsolateral plates; spinous caudal peduncle.

Counts. D. VIII-X-12-14; A. 13-17; P1. 16-19; P2. I, 2; C. 6+5; Br. 6; V. 42-44; LLP. 39-44; PP. 3-4; MDR. 11-14; DLR. 26-28; SLR. 29-33; ILR. 37-40; VLR. 24-28; MVR. 11-14.

Proportional measurements. Head 3.4-3.7 in SL; predorsal 2.8-3.2; pectoral fin 4.4-5.2; pelvic fin 9.9-18.9; caudal fin 6.3-7.8. Snout 1.9-2.1 in HL; orbit diameter 4.1-5.1; interorbital width 3.4-5.8; dorsal fin 2.0-2.8; anal fin 0.6-2.8. Body width 1.0-1.2 in its depth. Width of caudal peduncle 0.8-1.2 in its depth. Pelvic-anus length 10.0-27.1 in pelvic-anal length.

Body elongate, compressed. Head moderate in size, compressed. Nasal bones with a forward spine and an ascending spine recurved posteriorly, attached to each other anteriorly. Nasal tube short, never reaching upper jaw. Snout flat, depressed, projecting forward beyond upper jaw. Length from snout tip to upper jaw 4.8-6.3 in HL. Ventral surface of snout with three patches of barbels, without tubercles. A pair of small spines on mesethmoid. Supraocular and parietal spines large. Frontal-parietal ridges nearly parallel to each other, slightly converged anteriorly. A small blunt spine on posterodorsal corner of orbit, just behind supraocular spine. Temporal ridge with a small blunt spine on pterotic, ending as a posttemporal spine. Eye large, without tubercles. Infraorbital ridge finely serrated, with a tiny spine on first infraorbital, ending as a second infraorbital spine with a supplementary spine. A small spine on vertical line between infraorbital ridge and posterior nasal tube. Free lachrymal and first infraorbital margins finely serrated. Cheek entirely covered with expanded second infraorbital. Mouth inferior, lower jaw far from upper one (7.0-13.6 in HL). Maxillary end with a patch of barbels (11-17), reaching slightly before anterior margin of orbit. Two short barbels on lower jaw. No cirri nor barbels on lower jaw. Preopercular spines two, upper one large, lower one small and blunt. Opercular ridge very low. Teeth on jaws, no teeth on prevomer and palatine.

Dorsal fins two, well separated. Interdorsal distance variable, 17.4-17.5 in HL. First dorsal fin originating at fourth or fifth plates of dorsolateral row. Anal origin below posterior part of first dorsal fin. Pectoral fin with a cleft, lower rays thickened. Pelvic fin short, just below pectoral fin base. Anus just behind pelvic fin base. A long urogenital papilla in fully matured male and female. Caudal fin moderate in size, emarginate.

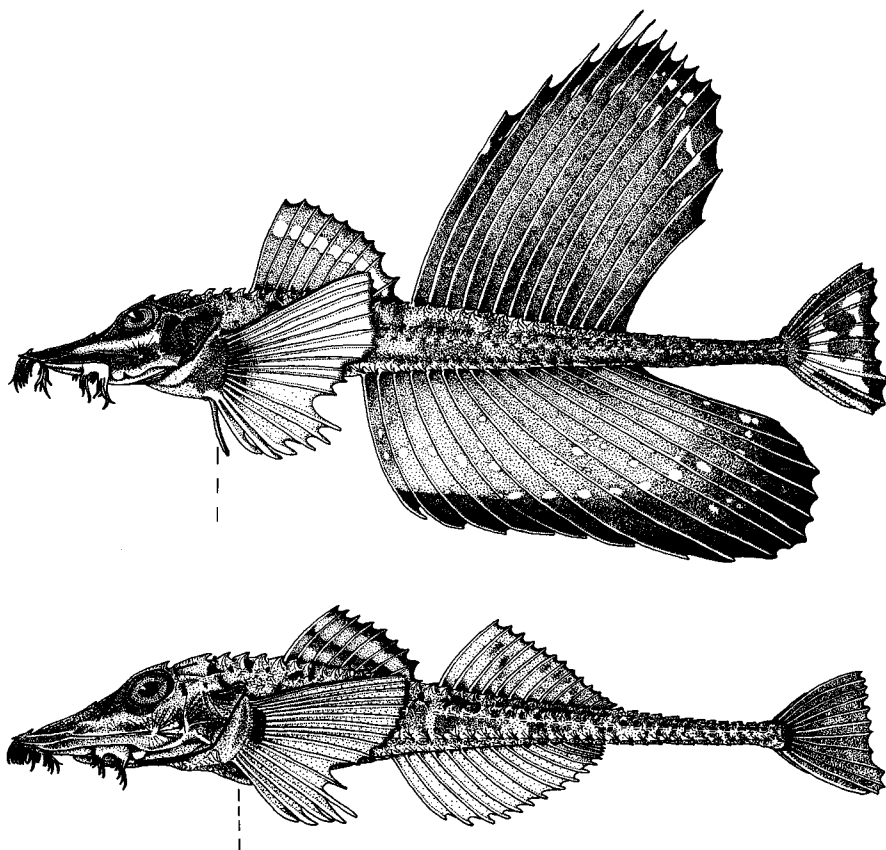

Fig. 20. *Podotheucus sachi* (Jordan et Snyder): HUMZ 42489, 348.6 mm SL, male (top).
HUMZ 42781, 258.4 mm SL, female (bottom).

A sharp spine on middorsal, dorsolateral, supralateral and infralateral plates. Spines on ventrolateral plates, sharp anteriorly, blunt posteriorly. Midventral plates with a tiny spine. Lateral line plates with a spine anteriorly, without spine posteriorly. Breast plate with a small spine. Subpectoral plates 5-7, between lateral line plates and infralateral plates. Tubercles or tiny plates on ethmoidal region and lower margin of orbit. A plate on cheek small, between second infraorbital and lower preopercular ridge. No plate on gular and gill membranes. Region between anus and anal origin with small plates.

Color. In preserved specimens, body brown, with irregular blotches. Two cross bands on back, one just behind head, one on second dorsolateral plate. A dark blotch on axil. A dark streak on middorsal of head. Snout with a dark streak from snout tip to lower margin of orbit. Dark spots on postorbital region. Anterior patch of snout barbels dark, posterior patch pale. First dorsal fin dark, with a pale band. Second dorsal fin dark. Anal fin pale, darker posteriorly. Pectoral fin pale

Table 5. Comparison of *Podothecus sachi* and *P. xystes*.

	Present specimens of <i>P. sachi</i>	Holotype of <i>P. xystes</i>
Number of specimens	25	1
Standard length (mm)	124.3-348.6	170.6
Dorsal spines	8-10	9
Dorsal rays	12-14	11
Anal rays	13-17	15
Pectoral rays	16-19	17
Lateral line plates	39-44	43
Middorsal plates	11-14	13
Dorsolateral plates	26-28	27
Supralateral plates	29-33	32
Infralateral plates	37-40	39
Ventrolateral plates	24-28	26
Midventral plates	11-14	13
Vertebrae	42-44	43
Number of patches of snout barbels	3	3

with dark spots on upper base. Pelvic fin pale. Caudal fin dark. Mouth and gill cavities, and peritoneum pale.

Sexual dimorphism. Second dorsal, anal and pelvic fins in male longer than those in female (Fig. 20).

Distribution. Northern Japan south to Hamada, Shimane Prefecture and Sagami Bay; eastern coast of Korea to Peter the Great Bay.

Remarks. *Podothecus xystes* was originally described by Snyder (1911), based on a specimen from Nagaoka, Japan, for which data is shown in Table 5. There was no apparent difference between *P. sachi* and *P. xystes*, and the latter is considered to be a junior synonym of *P. sachi*.

The elongation of the second dorsal, anal and pelvic fin rays in male of *P. sachi* is more remarkable than in the males of other species of *Podothecus*.

P. sachi is common on muddy sand bottoms in depths of 150 m or less, and feeds on crustaceans and marine worms. Two female specimens of *P. sachi*, collected from off Usujiri, Hokkaido, in October, 1981, had well ripened eggs in the oviduct. The spawning season of this species appears to be during October to November.

Materials. 26 specimens, 124.3-348.6 mm SL. CAS-SU 20702, holotype of *Podothecus xystes*, off Nagaoka, Japan; HUMZ 16546, Oshoro Bay, Japan Sea coast of Hokkaido, 28 April 1959; HUMZ 16654, Oshoro Bay, 16 April 1959; HUMZ 33262, 42°26'N, 140°34'E, Funka Bay, 18 May 1965; HUMZ 33263, 42°17'N, 140°44'E, 18 May 1965; HUMZ 33287, 42°15'N, 140°28'E, 18 May 1965; HUMZ 33496, 42°30'N, 143°45'E, depth 150 m, off Hiroo, 13 April 1968; HUMZ 42489, 42781, 42°09'N, 139°41'E, 290 m, off Okushiri I., 4 June 1975; HUMZ 45728, 45732, 45734, 45769, 42°52'N, 144°36'E, 60 m, off Kushiro, 16 July 1975;

HUMZ 45916, 42°54'N, 144°36'E, 40 m, 16 July 1975; HUMZ 47503, 42°32'N, 143°48'E, 87 m, off Ootsu, 6 September 1975; HUMZ 48864, 48867, 48927, 45°54'N, 141°31'E, 95-115 m, Soya Strait, 3 October 1975; HUMZ 59627, off Sanriku (Miyako fish market), Iwate Pref., 13 October 1976; HUMZ 64782, off Kamo, Yamagata Pref., 250-300 m, 26 November 1977; HUMZ 65075, Funka Bay; HUMZ 68364-68366, 43°48'N, 141°11'E, 185-194 m, off Ohuyu, 15 May 1977; HUMZ 87204, off Usujiri, 7 May 1980; IFES 177, off Kamaishi (Kamaishi fish market), December 1938.

Genus *Agonus* Bloch et Schneider, 1801

Agonus Bloch and Schneider, 1801, p. 104 (type species, *Cottus cataphractus* Linnaeus by subsequent designation by Gill, 1862c).

Aspidophorus Lacépède, 1801, p. 221 (type species, *Aspidophorus armatus* Lacépède = *Cottus cataphractus* Linnaeus by subsequent designation by Jordan, 1917).

Phalangistes Tilesius, 1814, p. 116 (type species, *Cottus cataphractus* Linnaeus).

Paragonus Ribeiro, 1918, p. 787 (type species, *Paragonus sertorii*).

Ribeiroa Jordan, 1920, p. 564 (type species, *Paragonus sertorii*).

External diagnosis. *Agonus* is distinguished from other genera of the family Agonidae in having the following characters: two dorsal fins; no barbel on snout tip; nasal tube short, never reaching upper jaw; nasal bones attached to each other anteriorly; a nonspinous rostral plate; nasal bone projecting forward beyond upper jaw; two nasal spines, one directed forward, one recurved posterodorsally; no ethmoidal spine; absence of supraocular spine; one or two pairs of barbels on ventral surface of snout; two or three maxillary barbels; no barbel on lower jaw tip; numerous short barbels on gular and gill membranes; gill membranes united, widely fused with isthmus; six branchiostegal rays; no occipital pit; 5-6 dorsal spines; 6-7 anal fin rays; 3-6 predorsal plates; supralateral plates; breast covered with enlarged bony plates.

Internal diagnosis. *Agonus* differs from other genera of Agonidae in possessing the following osteological characters: lachrymal without median shelf; ascending process of premaxillary shorter than alveolar process; interhyal shorter than epihyal; plate-like urohyal; no basihyal; three basibranchials; exoccipital never exposed; no tabular bone; three actinosts on pectoral girdle; two postcleithra; absence of postpelvic spine; no pleural rib; first dorsal proximal radial inserted into sixth space between sixth and seventh neural spines, supporting one spine; interdorsal bones continuously inserted into interneural spaces between separated two dorsals; one epural.

Remarks. Schmidt (1936) included the genera *Agonus*, *Podothecus* and *Leptagonus* in the genus *Agonus*. However, Andriashev (1954) discussed the status of *Agonus* and opposed Schmidt's view. As discussed under "phylogenetic classification," *Agonus* is characterized by two derived characters, a rostral plate and absence of a bridge of the trigeminal facialis chamber. *Agonus* shares a common ancestor with *Podothecus*. The common ancestor of the *Agonus*-*Podothecus* stem is the sister group of *Agonopsis*. *Leptagonus* has a common ancestor with the *Agonus*-*Podothecus*-*Agonopsis* stem. Thus, the monotypic genus *Agonus* is well differentiated from both *Podothecus* and *Leptagonus*, and I therefore agree with Andriashev (1954).

Agonus is represented by a single species, which is confined to the North Sea.

Agonus cataphractus (Linnaeus, 1758)

Fig. 21.

Cottus cataphractus Linnaeus, 1758, p. 264 (not seen).*Cottus brodamus* Bonnaterre, 1788, p. 67 (description; locality, North Sea).*Agonus cataphractus*. Bloch and Schneider, 1801, p. 104 (short description).*Aspidophorus armatus* Lacépède, 1801, pp. 222-224. (description).*Phalangistes cataphractus*. Tilesius, 1814, p. 113 (a new genus).*Cataphractus schoneveldii* Fleming, 1828, p. 216 (not seen).*Aspidophorus europaeus* Cuvier in Cuvier and Valenciennes, 1829, p. 201 (description).*Aspidophorus cataphractus*. Jenyns, 1842, pp. 31-32 (mentioned in text).*Paragonus sertorii* Ribeiro, 1918, p. 787 (description).*Ribeiroa sertorii*. Jordan, 1920, pp. 564 and 567 (substitute name for *Paragonus*).*Diagnosis.* See account of the genus *Agonus*.*Counts.* D. V-VI-6-7; A. 6-7; P1. 15-17; P2. I, 2; C. 6+5; Br. 6; V. 36-39; LLP. 32-39; PP. 3-6; MDR. 9-12; DLR. 20-24; SLR. 24-28; ILR. 32-35; VLR. 18-22; MVR. 8-14.*Proportional measurements.* Head 3.7-4.1 in SL; predorsal 2.5-2.7; pectoral fin 4.0-4.7; pelvic fin 5.9-6.8; caudal fin 5.2-6.1. Snout 2.8-3.7 in HL; orbit diameter 3.7-4.6; interorbital width 3.4-4.7; dorsal fin 2.2-2.6; anal fin 2.2-3.0. Body width 0.6-0.8 in its depth. Width of caudal peduncle 1.1-1.6 in its depth. Pelvic-anus length 3.0-4.1 in pelvic-anal length.

Body elongate, depressed, tapering to caudal peduncle. Posterior half of caudal peduncle compressed. Head small depressed. Nasal bone with two strong spines, one directed forward, one directed dorsally and slightly recurved posteriorly. Nasal bones projecting beyond upper jaw, attached to each other anteriorly. Posterior nasal tube short, never reaching upper jaw. Snout highly depressed, triangular in dorsal view. A bony knob on center of ventral surface of snout. One or two short barbels on ventral surface of snout. No ethmoidal spine. Nasal-ethmoid ridge indistinct, smooth. No spine on supraocular and parietal. Temporal ridge smooth, ending as a blunt posttemporal spine. Lower jaw included in upper one. Maxillary reaching pupil, with two or three barbels. Eye small, with bony tubercles on upper part. Infraorbital ridge with three spines, one on lachrymal blunt, one on first infraorbital, one on second infraorbital sharp and strong with a supplementary knob. Free lachrymal margin with two blunt knobs. First infraorbital with a blunt knob. Second infraorbital wide, lower margin reaching lower ridge of preopercle. Preopercular spines two, uppermost large, expanded laterally, lower small and blunt. Numerous short barbels on gular, gill membrane, lower jaw

Fig. 21. *Agonus cataphractus* (Linnaeus). Taken from Muus and Dahlstrøm, 1974.

and ventral margin of second infraorbital. Gill membranes united, joined to isthmus, with posterior, narrow free margin. Teeth on jaws, no teeth on prevomer and palatine.

Dorsal fins two, separated in short distance. Anal fin originating just below second dorsal origin. Pectoral fin sublateral never reaching anal origin. Pelvic fin short. Caudal fin round.

Plates of dorsolateral, supralateral and infralateral rows, with a blunt spine anteriorly, smooth posteriorly. Middorsal, ventrolateral and midventral plates, and breast plates smooth. Anterior plate of lateral line with a small spine. Head coarsely covered with tiny plates. Lower margin of orbit with tiny plates. No plate on gular, isthmus and cheek regions. Subpectoral region between lateral line and infralateral plates, with small plates. Anus surrounded by irregular small plates.

Color. In preserved specimens, body brown, paler ventrally, darker dorsally. Six dark cross bands on body. Head darker dorsally, paler ventrally. Dorsal, pectoral, anal and pelvic fins pale. Dorsal fin with dark irregular blotches. Pectoral fin with two indistinct dark bands, one basally, one indistinct and centrally. Dark spots on pectoral fin rays. Caudal fin dark, with pale margin. Mouth and gill cavities densely pigmented. Peritoneum pale.

Sexual dimorphism. Not examined.

Distribution. White Sea ; Barentz Sea ; Norwegian Sea ; North Sea ; Baltic Sea ; English Channel.

Remarks. In the North Atlantic, there are four species of the family Agonidae, *Agonus cataphractus*, *Leptagonus decagonus*, *Aspidophoroides monopterygius* and *Ulcina olriki*. *A. cataphractus* is easily distinguished from *L. decagonus* in having a forwardly projecting nasal spine, numerous short barbels on the gular and gill membranes, and lacking a supraocular spine. The former differs also from *A. monopterygius* and *U. olriki*, by having two dorsal fins, a forwardly projecting nasal spine, one or two barbels on the ventral surface of the snout, and numerous short barbels on the gular and gill membranes. In addition to its diagnostic differences, *A. cataphractus* is confined to European waters, whereas the other three are not encountered there.

A. cataphractus is common in the coastal zones of Europe, and reaches 15 cm in SL. It feeds on crustaceans and polychaetes on the bottom, some 35-270 m in deep. Females deposit their eggs (1.8-2.2 mm in diameter) in the alga, *Laminaria rhizoids* (in Andriashev, 1954). In the North Sea, the spawning period is from February to May (May to July in Iceland). Hatching is from December to May.

Materials. 13 specimens, 64.9-114.0 mm SL. HUMZ 64425-64434, Danish waters ; UBC 56-93, probably English waters ; UBC 57-58, Station at Plymouth, England.

Genus *Agonopsis* Gill, 1862

Agonopsis Gill, 1862c, p. 167 (type species, *Aspidophorus chiloensis* Jenyns).

Stelgis Jordan and Starks, 1895, p. 821, pl. xc (type species, *Podothecus vulsus* Jordan et Gilbert, preoccupied by *Stelgis pomel*, a sponge).

Averruncus Jordan and Starks, 1895, p. 821 (type species, *Averruncus emmelane* Jordan et Starks).

Xystes Jordan and Starks, 1895, p. 824 (type species, *Xystes axinophrys* Jordan et Starks).

Ganoideus Whitley, 1950 (type species, *Stelgis vulsus*).

External diagnosis. *Agonopsis* is distinguished from other genera of the family Agonidae in having the following characters: two dorsal fins; no barbel on snout tip; short nasal tube never reaching upper jaw; nasal bones attached to each other anteriorly; a nonspinous rostral plate; nasal bone projecting forward beyond upper jaw; two nasal spines, one directed forward, one recurved posterodorsally; presence or absence of ethmoidal spine; a spine on supraocular and parietal; a pair of barbels on ventral surface of snout or lacking; two or three maxillary barbels; no barbel on lower jaw tip; numerous short barbels or cirri on gular and gill membranes; gill membranes united, widely fused with isthmus; six branchiostegal rays; an occipital pit; 5-9 dorsal spines; 7-11 anal fin rays; 5-7 predorsal plates; supralateral plates; breast covered with enlarged bony plates.

Internal diagnosis. *Agonopsis* differs from other genera of Agonidae in possessing the following osteological characters: lachrymal without a median shelf; ascending process of premaxillary shorter than alveolar process; interhyal shorter than epihyal; plate-like urohyal; no basihyal; three basibranchials; exposed exoccipital; no tabular bone; three actinosts on pectoral girdle; two posteleithra; absence of postpelvic spine; no pleural rib; first dorsal proximal radial inserted into sixth space between sixth and seventh neural spines, supporting one spine; interdorsal bones continuously inserted into interneural spaces between separated two dorsals; one epyral.

Remarks. *Agonopsis* is closely similar to *Agonus* in having barbels or cirri on the gular and gill membranes, a rostral plate, and no patches of barbels on the ventral surface of the snout. *Agonopsis* clearly differs from *Agonus* in having an occipital pit, and a spine on the supraocular and parietal.

Agonopsis is represented by three species confined to the western coast of North America and the Patagonian region.

Key to the species of *Agonopsis*

- 1a. Anal fin ray more than 10. Ascending ethmoidal spine present. Triangular terminal rostral plate beneath skin. Peritoneum black. *A. vulsa*
- 1b. Anal fin ray less than 10. Ascending ethmoidal spine absent. A free, terminal rostral plate exposed. Peritoneum silver. 2.
- 2a. A pair of barbels on ventral surface of snout. *A. sterletus*
- 2b. No barbel on ventral surface of snout. *A. chiloensis*

Agonopsis vulsa (Jordan et Gilbert, 1881)

Fig. 22.

Agonus vulsus Jordan and Gilbert, 1881b, pp. 330-332 (original description; type locality, off Point Reyes, California).

Podothecus vulsus. Jordan and Gilbert, 1881c, p. 454 (listed).

Agonus valsus. Collett, 1894, pp. 671 and 674 (mentioned in text).

Stelgis vulsus. Jordan and Starks, 1895, p. 821, pl. 90 (new genus).

Averrunco emmelane Jordan and Starks, 1895, p. 821, pl. 91 (original description; type locality, Port Orchard, Puget Sound).

Xystes axinophrys Jordan and Starks, 1895, p. 824, pl. 92 (original description; type locality, Port Orchard, Admiralty Inlet).

Agonopsis emmelane. Wilimovsky, 1954, p. 286 (listed).

Agonopsis vulsa. Hubbs, Follett and Dempster, 1979, p. 20 (listed).

Diagnosis. In addition to the characters in the key, *A. vulsa* is distinguished from other species of *Agonopsis* in having the following characters: eight or more dorsal spines; 14-15 pectoral fin rays.

Counts. D. VIII-IX-7-9; A. 10-11; P1. 14-15; P2. I, 2; C. 6+5; Br. 6; V. 39-40; LLP. 40-42; PP. 6; MDR. 7-9; DLR. 29-32; SLR. 37-38; ILR. 36-38; VLR. 29-30; MVR. 7-9.

Proportional measurements. Head 3.7-4.0 in SL; predorsal 2.6-2.9; pectoral fin 5.4-5.8; pelvic fin 9.6-11.6; caudal fin 7.0-8.0. Snout 3.0-3.2 in HL; orbit diameter 3.4-4.0; interorbital width 6.0-7.4; dorsal fin 2.2-3.1; anal fin 2.3-2.9. Body width 0.8-0.9 in its depth. Pelvic-anus length 3.9-4.3 in pelvic-anal length.

Body elongate, depressed. Spinous head small, depressed. Tiny bony plates four on middorsal surface of head. No ethmoidal spine. Preocular and postocular spines present. Two sharp spines on parietal ridge. A shallow depression present on occipital region. Nasal bones with a forward spine and an ascending spine recurved posteriorly, attached to each other. A rostral plate without spine, beneath skin. Nasal tube short, never reaching upper jaw. Snout pointed, projecting forward beyond upper jaw, with a pair of barbels. Eye moderate in size, with some rows of tiny bony plates on upper margin of it. Free lachrymal margin with three blunt spines. Infraorbital ridge with a spine. Mouth inferior, with two short barbels at posterior corner. Cirri on gular and gill membranes. Preopercular spines four, upper three large. Gill membranes united, joined to isthmus. Teeth on jaws, palatine and prevomer.

Dorsal fins two, separated 4.9-8.7 in HL. Dorsal fin originating at sixth dorsolateral plate. Anal origin just below last dorsal spine. Pectoral fin sublateral. Pelvic fin short, inserted below pectoral fin base. Anus present posterior to pelvic fin base. Caudal fin round.

Sharp spines on middorsal, dorsolateral, supralateral and infralateral plates. Spines on ventrolateral plates, sharp anteriorly, blunt posteriorly. Midventral plates with a blunt spine or a knob. Breast plate with a knob, smooth. Cheek plates small, 2-4. Tiny plates on gular region.

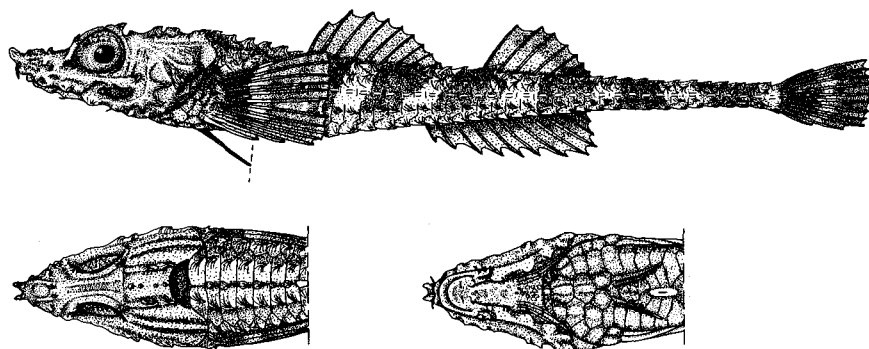

Fig. 22. *Agonopsis vulsa* (Jordan et Gilbert): HUMZ 17449, 105 mm SL.

Color. In preserved specimens, body brown, with six dark cross bands. Fins dark, with pale blotches. Peritoneum pale brown, with dark pigments.

Sexual dimorphism. not examined.

Distribution. West coast of North America from Strait of Georgia south to Puget Sound.

Remarks. *Agonopsis vulsa* was first described by Jordan and Gilbert, 1881, as *Agonus vulsus*. Four years later, Jordan and Starks (1895) reported a new species, *Averruncus emmelane*. Both names have been used, until Hubbs, Follett and Dempster (1979) listed only *Agonopsis vulsa*, as one of the fishes of California, without any comments. A comparison of the holotype of *Agonopsis vulsa* with the original description of *A. emmelane*, showed that no differences existed between them.

A. vulsa is confined to the West coast of North America, living on the muddy bottom in 55-75 m.

Materials. 5 specimens, 88.9-118.0 mm SL. HUMZ 17445-17447, 17449, off Vancouver, Canada, 26 Feb. 1934; USNM 27756, holotype of *Agonus vulsus*, Pt. Reyes, California, 1880.

Agonopsis sterletus (Gilbert, 1898)

Fig. 23.

Averruncus sterletus Gilbert, in Jordan and Evermann, 1898, pp. 2069 and 2071-2072 (original description; type locality, off Coronado I., southern California).

Agonopsis sterletus. Fitch, 1966, p. 123 (in key).

Diagnosis. In addition to the characters in the key, *A. sterletus* is distinguished from other species of *Agonopsis* in having the following characters: seven dorsal spines; 12-13 pectoral fin rays; anal fin originating below interdorsal space near second dorsal origin.

Counts. D. VII-7; A. 8-9; P1. 12-13; P2. I, 2; C. 6+6; Br. 6; V. 38-39; LLP. 39-40; PP. 6; MDR. 8-9; DLR. 28; SLR. 36-37; ILR. 35-36; VLR. 27-28; MVR. 8-9.

Proportional measurements. Head 4.3-4.6 in SL; predorsal 3.0-3.2; pectoral fin 5.4-6.0; pelvic fin 9.4-10.4; caudal fin 6.6-7.8. Snout 3.7 in HL; orbit diameter 3.5-3.6; interorbital width 7.6-7.8; dorsal fin 2.4-2.6; anal fin 2.5-2.8. Body width 0.8 in its depth. Pelvic-anus length 5.7 in pelvic-anal length.

Body slender, tapering to caudal peduncle. Head moderate in size, depressed. A row of tiny plates on middorsal surface of head. No ethmoidal spine. A sharp spine on preocular and postocular. Frontal-parietal ridge with three spines. A depression present just behind head. Snout short, pointed. Nasal bones attached to each other, with a forwardly projecting spine and an upturned one. A rostral plate nonspinous; egg like shaped. A pair of short barbels present on ventral surface of snout. Nasal tube short. Eye moderate in size, with prickles on upper margin. Free lachrymal margin smooth, with two blunt spines and a sharp spine. Infraorbital ridge expanded laterally, ending as a spine. Mouth moderate in size, inferior. Maxillary beyond anterior margin of orbit, with two barbels on posterior end. Cirri on gular and gill membranes. Preopercular spines four. Gill membranes united, joined to isthmus. Teeth on jaws, palatine and prevomer.

Dorsal fins two, separated. Interdorsal distance 3.7-4.5 in HL. Dorsal fin

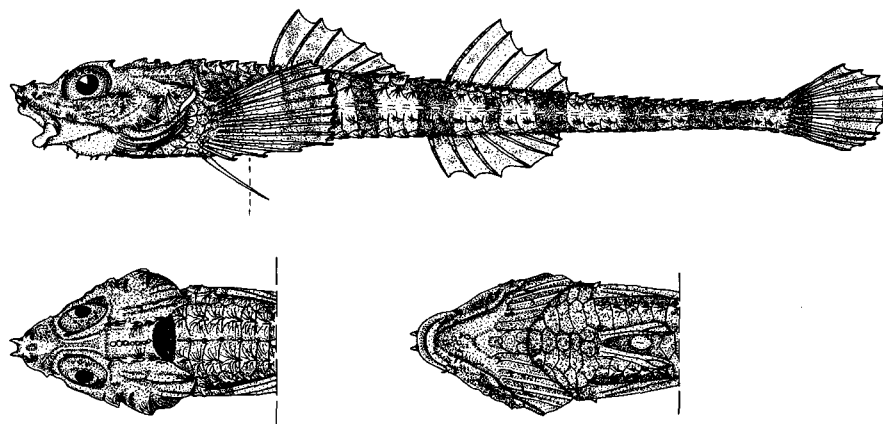

Fig. 23. *Agonopsis sterletus* (Gilbert): LACM 2082, 106.6 mm SL.

originating sixth dorsolateral plate. Anal origin below interdorsal space, near second dorsal origin. Pectoral fin sublateral, never reaching anal origin. Pelvic fin short, just below pectoral fin base. Anus present near pelvic fin base. Caudal fin small, round.

A sharp spine on middorsal, dorsolateral, supralateral, and infralateral plates. A spine on ventrolateral plates sharp anteriorly, blunt posteriorly. Midventral plates with a knob. Breast plates smooth, with a knob. Cheek plate small, with a spine or a knob. Tiny plates present on gular region.

Color. In preserved specimens, body brown, with seven dark bands. Fins dark. Pectoral and caudal fins with two bands, one at fin base, one at posterior half. Peritoneum silver, without pigments.

Sexual dimorphism. Not examined.

Distribution. Coast of southern California.

Remarks. *Agonopsis sterletus* is considered to be a sister species of *A. chiloensis* based on two synapomorphies, the attachment between the frontal and parasphenoid and the posterior insertion of the first anal pterygiophore. The former is confined to the west coast of North America, but the latter distributes only off Patagonian Region of South America.

Materials. 2 specimens, 108.7-119.0 mm SL. LACM 20821-2, East of Long Point, Santa Catalina I., California, 45-50 fathoms, 10 August 1941.

Agonopsis chiloensis (Jenyns, 1842).

Fig. 24.

Aspidophorus chiloensis Jenyns, 1842, p. 30 (original description; type locality, west coast of northern Patagonia).

Aspidophorus niger Kröyer, 1845, pp. 238 and 249 (description).

Agonus niger. Günther, 1860, p. 215 (description; locality, Valparaiso).

Agonus chiloensis. Günther, 1860, p. 216 (description; locality, coast of Chile).

Agonopsis chiloensis. Gill, 1862c, p. 167 (listed).

Agonopsis asperoculis Thompson, 1916, pp. 404 and 409-411, pl. 2, fig. 1 (original description;

locality, South of La Plata River).

Diagnosis. In addition to the characters in the key, *A. chilensis* is distinguished from other species of *Agonopsis* in having the following characters: 5-7 dorsal spines; 12-13 pectoral fin rays; anal fin originating slightly before second dorsal fin.

Counts. D. V-VII-6-8; A. 7-9; P1. 12-13; P2. I, 2; C. 6+6; Br. 6; V. 38-40; LLP. 38-42; PP. 5-7; MDR. 8-11; DLR. 25-29; SLR. 35-38; ILR. 35-37; VLR. 25-28; MVR. 8-12.

Proportional measurements. Head 4.0-4.4 in SL; predorsal 3.6-3.9; pectoral fin 5.4-6.2; pelvic fin 8.2-12.4; caudal fin 6.6-7.5. Snout 3.6-3.9 in HL; orbit diameter 3.2-4.2; interorbital width 5.5-7.2; dorsal fin 2.6-3.0; anal fin 2.3-2.9. Body width 0.8-0.9 in its depth. Pelvic-anus length 4.5-5.6 in pelvic-anal length.

Body elongate, depressed, gradually tapering from immediately behind head to caudal region. Caudal peduncle slightly compressed. Head depressed, with a row of tiny bony plates present on middorsal surface. Ethmoidal spine absent. Preocular, postocular, tympanic, parietal and supracleithral spines present. Occipital region concave. Snout short, projecting forward beyond upper jaw, with a pair of barbels. Nasal bone attached to each other at anterior part. Nasal spines two, one projecting forward, and one ascending and toward to back. A terminal rostral plate lacking a spine. Nasal tube short, never reaching upper jaw. Eye moderate in size, with some rows of tiny bony plates on upper margin. Free lachrymal margin with three blunt spines. Mouth inferior. Lower jaw including upper one. Maxillary end reaching below middle of eye, with two barbels. Tiny cirri present on ventral surface of lower jaw and gill membranes. Gill membranes united with each other, joined to isthmus, without free fold. Preopercular spines three, uppermost spine large. Teeth on jaws, palatine and prevomer.

Dorsal fins two, well separated. Interdorsal distance 2.5-4.0 in HL. First dorsal fin originating backward, sixth dorsolateral bony plate. Anal fin originating at a little backward of middle of body. Second dorsal origin present above anal

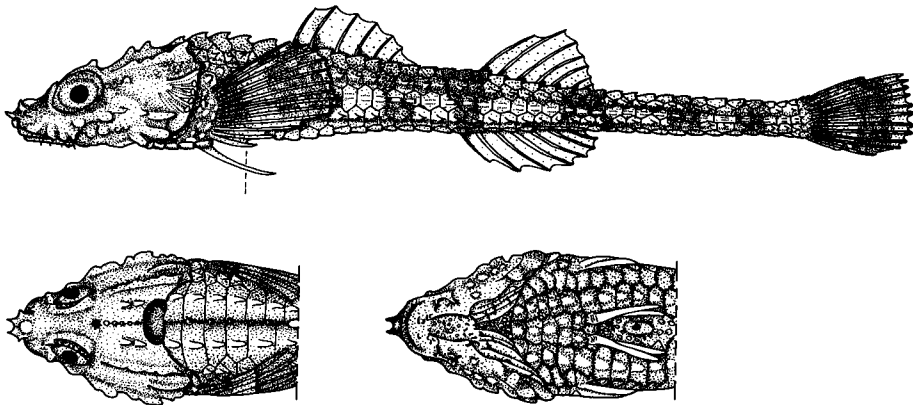

Fig. 24. *Agonopsis chilensis* (Jenyns): BMNH 1132, 109.8 mm SL.

origin. Pectoral fin sublateral. Pelvic fin slender, short. Caudal fin small, round.

Body plates with a spine or a knob. Ventral surface smooth, without spines. Lateral line plates without spines. Five bony plates present below infraorbital bones. Gular region with tiny bony plates.

Color. In preserved specimens, body brownish with five dark vertical bands. Ventral pale. Head brown, ventral surface pale. Dorsal fins pale, with dark spots. Anal fin pale, with dark base. Pectoral and caudal fins with dark bands at basal and posterior parts. Pelvic fin pale. Peritoneum pale, silver like.

Sexual dimorphism. Not examined.

Distribution. Coast of Chile and Patagonian-Falklands regions.

Remarks. *Agonopsis chiloensis* is living in the shallow waters, in 15-75 m.

Materials. 12 specimens, 79.8-109.8 mm SL. BMNH 1132-1142, East of Falkland I., depth 82 m, 23 February 1927.

3. Subfamily Anoplagoninae Gill, 1862

Anoplagoninae Gill, 1862d, p. 260.

Aspidophoroidinae Jordan and Evermann, 1898, p. 2033.

Bathyagoninae Lindberg, 1971, pp. 223-226.

Bothragoninae Lindberg, 1971, pp. 223-226.

Xenertminae Leipertz, 1988, p. 69.

External diagnosis. Anoplagoninae are distinguished from other subfamilies of the family Agonidae in having the following characters: an enlarged rostral plate on snout tip; nasal bones never projecting forward beyond upper jaw; concave upper margin of orbit; gill membranes joined to isthmus; terminal mouth, rarely superior; predorsal region never highly elevated.

Internal diagnosis. Anoplagoninae differ from other subfamilies of Agonidae in possessing the following osteological characters: attachment among lachrymal, nasal and a rostral plate; absence or rare presence of attachment between entopterygoid and metapterygoid; one rostral plate; smooth anterior free nasal margin; absence of forward projection of nasal; absence or rare presence of attachment between prevomer and ethmoid; small anterior process of ethmoid; concave dorsal margin of orbit; three actinosts on pectoral girdle; no pore between actinosts; no or one tabular bone; absence or rare presence of inner pelvic keel; posterior insertion of dorsal pterygiophores; no or one spine on first dorsal pterygiophore; continuous spinous dorsal pterygiophore; one epural.

Remarks. The subfamily Anoplagoninae contains seven genera, *Bothragonus*, *Bathyagonus*, *Xenertmus*, *Odontopyxis*, *Ulcina*, *Aspidophoroides*, and *Anoplagonus*.

Genus *Bothragonus* Gill, 1881

Bothragonus Gill, in Jordan and Gilbert, 1881c, p. 454 (type, *Hypsagonus swanii* Steindachner).

External diagnosis. *Bothragonus* is distinguished from other genera of the family Agonidae in having the following characters: two dorsal fins; dorsal fin with 2-4 spines and 4-5 rays; 4-6 anal fin rays; 11-12 pectoral fin rays; no snout barbel; nasal tube never reaching upper jaw; nasal bones attached to each other; a nonspinous rostral plate; nasal bone about equal to upper jaw; absence of ethmoidal and parietal spines; lower jaw included in upper jaw; maxillary with

one or two flaps; no barbel on lower jaw tip; teeth on palatine and prevomer; six branchiostegal rays; a large occipital pit just behind head; interdorsal distance 1.7-3.9 in HL; 32-38 vertebrae; 6-8 predorsal plates; 31-36 lateral line plates.

Internal diagnosis. *Bothragonus* differs from other genera of Agonidae in possessing the following osteological characters: attachment between lachrymal and nasal bone; an infraorbital shelf; ascending process of premaxillary shorter than alveolar process; a short interhyal; plate-like urohyal; no basihyal; three basi-branchials; exposed exoccipital; three actinosts on pectoral girdle; two postcleithra; a postpelvic spine; no pleural rib; posterior insertion of pterygiophore; posterior insertion of anal pterygiophore; two eprurals.

Remarks. This genus is represented by two species, *B. swani* and *B. occidentalis*. The former is confined to the western coast of North America, from Kodiak I. to California, but the latter is distributed in the waters of the Far East.

Key to the species of *Bothragonus*

- 1a. Dermal processes present in an occipital pit. Middorsal plate 6 or less. Midventral plate 3 or less. Infraorbital plate 3 or less. *B. swani*
- 1b. No dermal process in an occipital pit. Middorsal plate 12 or more. Midventral plate 10 or more. Infraorbital plate 5 or more. . . . *B. occidentalis*

Bothragonus swani (Steindachner, 1877)

(Japanese name: Debu-saitokubire)

Fig. 25.

Hypsagonus swanii Steindachner, 1877, pp. 192-195, pl. 4 (original description; type locality, Port Townsend, Washington).

Bothragonus swani. Gill, in Jordan and Gilbert, 1881c, p. 454.

Bothragonus swanii. Bean, 1882, p. 264 (locality, Puget Sound).

Diagnosis. In addition to the characters in the key, *B. swani* is distinguished from another species of *Bothragonus*, *B. occidentalis*, in having 32 vertebrae.

Counts. D. III-IV-4-5; A. 4-5; P1. 12; P2. I, 2; C. 7+5-6; Br. 6; V. 32; LLP. 31; PP. 6; MDR. 5-6; DLR. 21; SLR. 26-27; ILR. 28-30; VLR. 22-23; MVR. 2-3.

Proportional measurements. Head 2.6-2.7 in SL; predorsal 1.8; pectoral fin 3.4-3.7; pelvic fin 5.8-5.9; caudal fin 6.0-6.3. Snout 4.1-4.3 in HL; orbit diameter 6.1-6.2; interorbital width 3.9-4.2; dorsal fin 7.4-7.7; anal fin 3.7-3.8. Body width 0.9 in its depth. Width of caudal peduncle 2.6-3.1. Pelvic-anus length 3.4-4.2 in pelvic-anal length.

Body rhomboid, highest at dorsal origin. Head depressed. A large pit present just behind head, with three bony processes at its posterior margin. A nasal spine blunt, recurved posterodorsally. Nasal tube never reaching upper jaw. Snout round, never beyond upper jaw. Nasal bones attached to each other anteriorly. A rostral plate nonspinous, oval. No ethmoidal spine. A postorbital knob present. Eye small, with tubercles on upper margin. A band of prickles surrounding lower half of orbital margin. Interorbital wide, concave. A pentagonal depression on dorsal surface of head just behind orbit. Second infraorbital bone with a large knob. Free lachrymal margin with three knobs. Maxillary never reaching below

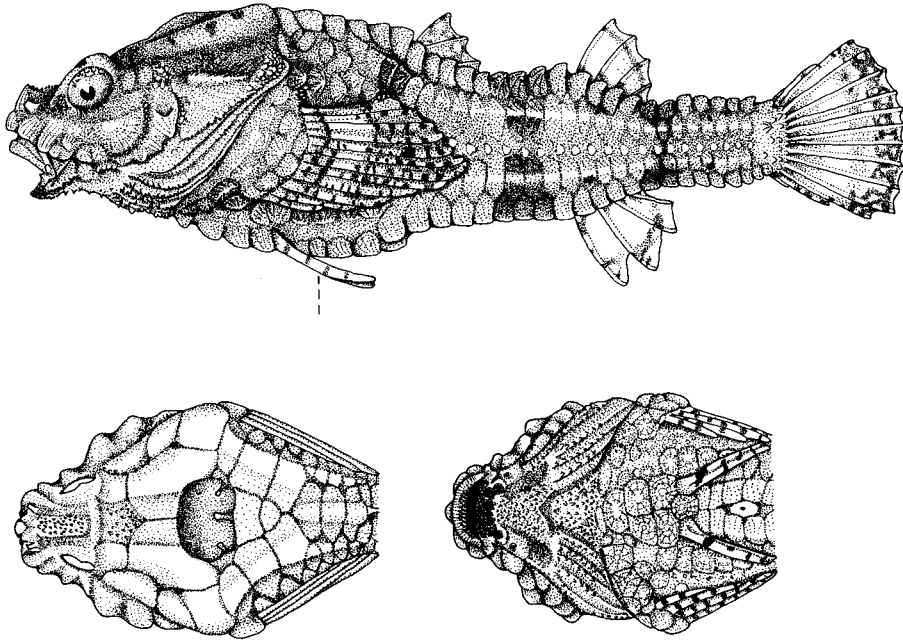

Fig. 25. *Bothragonus swani* (Steindachner): HUMZ 51922, 49.4 mm SL.

anterior margin of orbit. A flap on maxillary end. Upper jaw included in lower one. Teeth in band on jaws, palatine and prevomer. Gill membranes united, broadly fused with isthmus.

Dorsal fins two, well separated each other, 3.2-3.9 in HL. First dorsal fin tiny, originating at the seventh plate of dorsolateral row. Pectoral fin lanceolate, sub-lateral. Anus slightly behind pelvic fin base. Caudal fin truncate.

Body covered with bony plates. Plates smooth, with a knob. Unpaired plates of dorsolateral row two to three just in front of first dorsal origin, and two between two dorsals. Unpaired plates two on middorsal just behind head. Infraorbital plates two, without spine. Subpectoral plates large two and tiny one. Prepelvic plates II+2. Tiny tubercles on branchiostegal rays, gular region and jaws, and united gill membranes.

Color. In preserved specimens, body brown with three cross bands. Dorsal, anal and pelvic fins pale with dark spots. Pectoral fin dark with a pale band. Caudal fin pale, with dark bands distally and basally. Mouth and gill cavities dark. Peritoneum pale.

Distribution. Kodiak I. to Lion Rock, San Luis Obispo Co. (about 35°N).

Remarks. *Bothragonus swani* is a shallow water dweller, and is frequently captured in tide pools.

Materials. 2 specimens, 47.5-49.5 mm in SL. HUMZ 51922, 38°54'N, 123°43'W, depth 40-50 feet, off Arena Cove, Mendocino Co., California, U.S.A., 17 August 1972; UBC 53-263, 50°34'N, 126°58'W, off Alort Bay, Vancouver I., British Columbia, Canada, November 1950.

***Bothragonus occidentalis* Lindberg, 1935**

(Japanese name: Saitokubire)

Fig. 26.

Bothragonus occidentalis Lindberg, 1935, pp. 1223-1227, figs. 1-2 (original description; type locality, Suaukhy Bay, vicinity of Petrov I., about 43°N, 132°E, depth 35 m).

Diagnosis. In addition to the characters in the key, *B. occidentalis* is distinguished from *B. swani* in having 37-38 vertebrae.

Counts. D. II-IV-4-5; A. 6; P1. 11; P2. I, 2; C. 6+6; Br. 6; V. 37-38; LLP. 33-36; Gr. 0+3 (1 specimen); PP. 8; MDR. 12-13; DLR. 23-24; SLR. 32-33; ILR. 34-35; VLR. 25-26; MVR. 10-11.

Proportional measurements. Head 3.2-3.6 in SL; predorsal 2.2-2.4; pectoral fin 4.6-5.4; pelvic fin 7.1-8.0; caudal fin 6.9-7.5. Snout 3.8-4.6 in HL; orbit diameter 5.6-9.6; interorbital 3.5-4.5; dorsal fin 16.8-26.3; anal fin 3.5-4.4. Body width 0.7-0.8 in its depth. Width of caudal peduncle 3.3-5.2 in its depth. Pelvic-anus length 2.9-3.6 in pelvic-anal length.

Body elongate, depressed anteriorly, compressed posteriorly. Head depressed, smooth. A large pit just behind head, without dermal process in it. A nasal spine blunt. Nasal tube very short, never reaching upper jaw. Nasal bones attached to each other anteriorly. An oval rostral plate nonspinous. Ethmoid region smooth, without spine. A postorbital knob present. Snout short, never beyond upper jaw. Eye small, with 2-3 rows of papilla on its dorsal part. Interorbit wide, concave. A row of bony tubercles surrounding lower margin of orbit. Upper jaw included in snout. Second infraorbital bone with a large knob. Free lachrymal margin smooth without projection. Maxillary reaching anterior margin of orbit or not. Maxillary end with two flaps. Lower jaw included in upper jaw. Teeth on jaws, prevomer and palatine. Gill membranes widely united, fused with isthmus. Preopercular spines three, uppermost large and blunt.

Two dorsal fins well separated each other, 1.7-2.2 in HL. First dorsal fin tiny. Dorsal origin between ninth dorsolateral plates. Pectoral fin sublateral, lanceolate. Anus behind pelvic fin base in short distance. Caudal fin round.

Body plates with a tiny blunt spine. Seven unpaired plates of dorsolateral row between two dorsals. Unpaired plates on mid predorsal region. Infraorbital plates 5-6. Subpectoral plates six or more as a patch. Prepelvic plates three at breast,

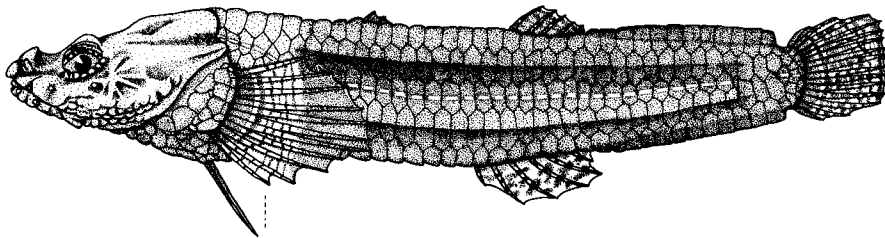

Fig. 26. *Bothragonus occidentalis* Lindberg: HUMZ 72239, 48.2 mm SL.

one paired plates and three unpaired plates. Small plates with a knob on branchiostegal rays, gular region and gill membranes. Small bony plates surrounding anus.

Color. In preserved specimens, body dark with a pale cross band at nape. All fins, except for pelvic fin, dark. Second dorsal and anal fins with pale spots. Pectoral fin with a wide pale band at middle part and pale margin. Caudal with 5-7 irregularly narrow stripes at its middle parts, pale marginally. Pelvic fin pale with dark spots. Oral and gill cavities dark. Peritoneum pale.

Distribution. Peter the Great Bay; off Omu, Okhotsk coast of Hokkaido; off Konbumori, near Kushiro; Habomai I., Kuril Is.

Remarks. *Bothragonus occidentalis* was reported from Japan by Kanayama and Maruyama (1979), based on four specimens collected off Omu and Konbumori.

Materials. 4 specimens, 32.8-48.2 mm in SL, from Japanese waters. HUMZ 72239, 44° 40'N, 142°57'E, depth 30 m, off Omu, 7 September 1976; HUMZ 77436-77438, 42°56'N, 144° 31'E, depth 35 m, off Konbumori, 10 August 1978.

Genus *Bathyagonus* Gilbert, 1890

Bathyagonus Gilbert, 1890, p. 89 (type species, *Bathyagonus nigripinnis* Gilbert).

Asterotheca Gilbert, 1915, pp. 343-344 (type species, *Xenochirus pentacanthus* Gilbert).

External diagnosis. *Bathyagonus* is distinguished from other genera of the family Agonidae in having the following characters: two dorsal fins; no barbel on snout tip; short nasal tube, never reaching upper jaw; nasal bones attached to each other anteriorly; an enlarged rostral plate with three upturned spines; no ethmoidal spine; maxillary with two barbels at its posterior corner; presence or absence of cirri on mandible; gill membranes united, fused with isthmus with a free fold; six branchiostegal rays; a pair of shallow occipital pits; 5-8 dorsal spines; 5-7 anal rays.

Internal diagnosis. *Bathyagonus* differs from other genera of Agonidae in possessing the following osteological characters: an infraorbital shelf; ascending process of premaxillary shorter than alveolar process; interhyal shorter than epiphyal; urohyal with a lateral keel; no basihyal; three basibranchials; exoccipital slightly exposed; three actinosts on pectoral girdle; two posteleithra; no pleural rib; one epural.

Remarks. The genus *Bathyagonus* contains four species, *B. nigripinnis*, *B. pentacanthus*, *B. alascanus*, and *B. infraspinatus*. These species are benthic dwellers, confined to the west coast of North America.

Key to the species of *Bathyagonus*

- 1a. Lower jaw projecting forward beyond upper jaw. All fins uniformly black. *B. nigripinnis*
- 1b. Jaws equal or lower jaw included in upper one. All fins not uniformly black. 2.
- 2a. Lateral line plates 44 or more. Dorsolateral plates 26 or more. Supralateral plates 40 or more. Infralateral plates 39 or more. *B. pentacanthus*
- 2b. Lateral line plates 41 or less. Dorsolateral plates 24 or less. Supralateral plates 38 or less. Infralateral plates 37 or less. 3.
- 3a. Free lachrymal margin smooth. A spine on lachrymal. Gill membranes

- without a posterior free fold. *B. alascanus*
 3b. Free lachrymal margin with three spines directed forward. Two spines on
 lachrymal. Gill membranes with a narrow, posterior free fold.
 *B. infraspinatus*

***Bathyagonus nigripinnis* (Gilbert, 1890)**

(Japanese name: Soko-tokubire)

Fig. 27.

Bathyagonus nigripinnis Gilbert, 1890, p. 89 (original description; type locality, coast of Washington and Oregon).

Diagnosis. In addition to the characters in the key, *B. nigripinnis* is distinguished from other species of *Bathyagonus* in having the following characters: first preopercular spine with a supplementary spine; no barbel on mandible; lachrymal with serrated ridge; 42-46 lateral line plates.

Counts. D. VI-VIII-6-7; A. 6-8; P1. 14-17; P2. I, 2; C. 6+5; Br. 6; V. 43-46; LLP. 42-46; Gr. 0-2+0-1+11-17; PP. 7-8; MDR. 15-17; DLR. 25-28; SLR. 39-43; ILR. 38-42; VLR. 21-42; VLR. 21-27; MVR. 16-19.

Proportional measurements. Head 4.5-5.0 in SL; predorsal 3.2-3.6; pectoral fin 5.1-6.0; pelvic fin 13.0-23.5; caudal fin 7.2-10.6. Snout 3.3-3.6 in HL; orbit diameter 2.7-3.1; interorbital width 9.3-13.5; dorsal fin 2.0-2.4; anal fin 2.1-2.6. Body width 0.7-0.9 in its depth. Width of caudal peduncle 0.7-1.0 in its depth. Pelvic-anus length 8.6-15.4 in pelvic-anal length.

Body slender, depressed. Head depressed, paddle like in dorsal view. A postocular spine at posterior upper corner of orbit. Two spines on parietal. Posttemporal ridge prominent, with two or three spines. Infraorbital ridge well developed, serrated, ending as a sharp spine directed posterolaterally. Free lachrymal margin finely serrated. Preopercular spines two; upper one with a supplementary spine larger than lower one. Opercle with a serrated ridge. Nasal bone with a spine, separated each other. Anterior end of nasal bone attached to a rostral plate. A rostral plate with five points; of these, one directed posterodorsally, two dorsolaterally, two laterally. Interorbital space concave. Two to four spinous plates below infraorbital bones. Snout moderate in size, flat dorsolaterally. Lower jaw projecting forward beyond upper jaw. Two flesh barbels on maxillary, posterior one larger than anterior. Maxillary end never reaching anterior margin of orbit. No barbel nor cirri on mandible. Eye large, with 1-5 bony tubercles or lacking. Gill membranes united and broadly fused with isthmus. No plate on gill membrane. Two or three plates on gular region. Villiform teeth on jaws, prevomer and

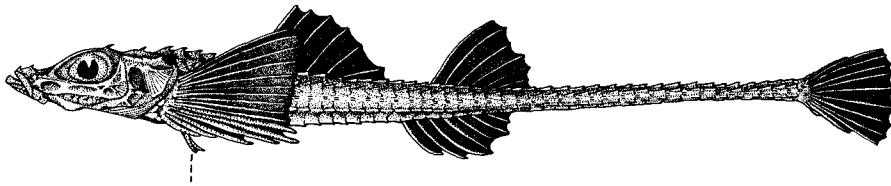

Fig. 27. *Bathyagonus nigripinnis* (Gilbert): HUMZ 84261.

palatine.

Two dorsal fins well separated, its distance 2.6-5.4 in HL. Pectoral fin without a notch, lower four or five rays slightly thickened. Pelvic fin short. Anal fin originating at just behind first dorsal fin.

A sharp spine on dorsolateral, middorsal, supralateral and infralateral plates. Ventrolateral and midventral plates with a blunt spine. Breast tightly covered with plates. Pectoral base with a row of tiny plates. First two or three lateral line plates with a well developed spine, other plates nonspinous. Small plates surrounding anus.

Color. When fresh, body uniformly light brown. All fins and gill membranes bluish black.

Sexual dimorphism. Pelvic fin longer in male than those in female.

Distribution. Oregon through Washington, British Columbia and Alaska to Bering Sea.

Remarks. *Bathyagonus nigripinnis* is taken abundantly by trawl in depths of 100-500 m.

Materials. 19 specimens, 124.0-204.4 mm SL. HUMZ 17462-17466, West coast of Vancouver I., 8 October 1956; HUMZ 44900, 55°51'N, 162°17'E, 287-300 m, 11 May 1975; HUMZ 84028, 54°19.90'N, 166°39.98'W, 730-750 m, 13 June 1979; MUMZ 84261, 59°37.32'N, 178°27.7'W., 470 m, 27 June 1979; HUMZ 84617, 56°11.20'N, 169°40.57'W, 330 m, 17 June 1979; HUMZ 84618-84620, 84623, 54°30.03'N, 167°18.13'W, 680 m, 11 June 1979; HUMZ 84824, 59°37.32'N, 178°27.70'W, 470 m, 27 June 1979; HUMZ 84759, 84761, 59°19.65'N, 178°06.70'W, 610 m, 28 June 1979; HUMZ 84845, 59°09.19'N, 168°21.84'W, 180 m, 17 June 1979; HUMZ 85049, 54°20.85'N, 166°19.95'W, 715 m, 13 June 1979; HUMZ 85855, 58°19.30'N, 164°59.70'W, 42 m, 10 July 1979.

Bathyagonus pentacanthus (Gilbert)

Fig. 28.

Xenochirus pentacanthus Gilbert, 1890, p. 91 (original description; type locality, coast of Washington, depth 178 fms).

Xenertmus pentacanthus. Gilbert, 1904, pp. 262-263 (mentioned in text).

Asterotheca pentacantha. Gilbert, 1915, pp. 344-345 (locality, Monterey Bay, San Nicholas I., Catalina I., and San Diego, depth 75-497 fms)

Bathyagonus pentacanthus. Fitch, 1973, pp. 815-817 (off Chirikof I. to San Diego, depth 198-216 m).

Asterotheca pentacanthus. Quast and Hall, 1972, p. 26 (listed).

Diagnosis. *Bathyagonus pentacanthus* is distinguished from other species of *Bathyagonus* in having the following characters: lower jaw slightly included in upper jaw; first preopercular spine without a supplementary spine; mandible barbels two; lateral line plates 44-45; dorsolateral plates 26-28; supralateral plates 40-43; all fins not uniformly black.

Counts. D. VI-VIII-6-7; A. 7-8; Pc. 15; Pv. I, 2; C. 6+5; Br. 6; V. 44-46; LLP. 44-45; Gr. 1+8; PP. 7-8; MDR. 15-16; DLR. 26-28; SLR. 40-43; ILR. 39-41; VLR. 22-25; MVR. 16-18.

Proportional measurements. Head 4.3-4.9 in SL; predorsal 3.1-3.5; pectoral fin 5.4-5.9; pelvic fin 12.9-16.9; caudal fin 8.4-9.5. Snout 3.2-3.6 in HL; orbit diameter 2.6-2.8; interorbital width 11.1-17.8; dorsal fin 1.9-2.5; anal fin 2.3-2.8. Body width 0.9 in its depth. Width of caudal peduncle 0.7-0.8 in its depth.

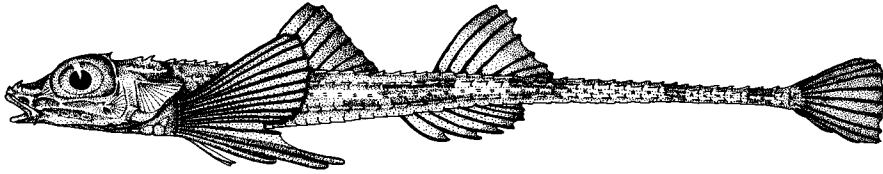

Fig. 28. *Bathyagonus pentacanthus* (Gilbert): HUMZ 62264.

Pelvic-anus length 14.3–22.3 in pelvic-anal length.

Head moderate, slightly depressed. A sharp postocular spine on upper corner of orbit. Two spines on parietal, one large and directed backward, one on anterior base of large spine as a prominent knob. Posttemporal ridge with three sharp spines and ending a sharp spine directed posteriorly as a posttemporal spine. Infraorbital ridge weakly serrated with three spines: one on lachrymal, two on second infraorbital. Free lachrymal margin undurated with a spine directed posteriorly. Two preopercular spines. Nasal with a recurved spine, attached to each other. A rostral plate with five points; one directed dorsally, two dorsolaterally, two directed laterally. Three spinous plates below infraorbital. Interorbital slightly concave. Snout short pointed. Mouth small. Lower jaw slightly included. One or two fleshy barbels on maxillary end. Two short barbels on mandible. Maxillary reaching anterior margin of orbit. Eye large, with a row of spinous tubercles. Gill membrane united, widely fused with isthmus and lacking a fold. Nonspinous plates on gular and united gill membrane. Villiform teeth on jaws, prevomer and palatine.

Two dorsal fins well separated, 2.8–3.7 in HL. Anal fin originating at middle of interdorsal space. Caudal fin truncate. Pectoral fin with a notch, lower three or four rays thickened.

Blunt spines on dorsolateral, middorsal, supralateral, infralateral, and ventrolateral plates. Midventral plates without spines. Prepelvic area covered with nonspinous plates. Upper half of prepectoral region without plates. Anus plates present.

Color. In preserved specimens, body brown with darker five bands. Dorsal and anal fins pale with darker band. Pectoral and pelvic fins pale. Caudal fin dark. Mouth pale. Gill cavity pigmented. Peritoneum dark.

Sexual dimorphism. Pelvic fin longer in male (12.9–15.1 in SL) than those in female (15.1–16.9).

Distribution. Gulf of Alaska to southern California, depth 137–910 m.

Remarks. Sasaki (1972) reported that *Bathyagonus pentacanthus* was rather common, and had been found in all areas investigated, but Fitch (1973) doubted the accuracy of the former's identifications. Examination of Sasaki's collection are confirmed their identity as *B. pentacanthus*, but the collection data does not necessarily indicate frequent occurrence of the species.

Evermann and Goldsborough (1907) erroneously recorded *B. pentacanthus* from the Bering sea. However, the species is now considered to occur only in waters from Gulf of Alaska to southern California.

Materials. 7 specimens, 158.6–180.2 mm SL. CAS 16708 (3 specimens), 36°20'45"N,

122°06'15"W, 208 fms., 12 November 1935; HUMZ 40420-40422, 51°15'N, 130°25'W, 367 m, 15 May 1969; HUMZ 62264, 55°23'N, 134°52'W, 15 June 1969.

***Bathyagonus alascanus* (Gilbert, 1896)**

Fig. 29.

Xenochirus alascanus Gilbert, 1896, p. 438 (original description; type locality, vicinity of Unimak Pass and north and south of the Aleutian Is., depth 35-138 fms).

Xenertmus alascanus. Gilbert, 1904, pp. 262-263 (listed).

Astrothea alascana. Gilbert, 1915, p. 344 (key).

Xenertmus alascanus. Kincaid, 1919, p. 36 (short description).

Bathyagonus alascanus. Fitch, 1973, p. 817 (reexamination of Evermann and Goldsborough's specimens as *Xenochirus pentacanthus*).

Diagnosis. In addition to the characters in the key, *B. alascanus* is distinguished from other species of *Bathyagonus* in having the following characters: first preopercular spine without a supplementary spine; one or two barbels on mandible.

Counts. D. V-VII-5-7; A. 6-7; P1. 14-15; P2. I, 2; C. 6+5; Br. 6; V. 39; Gr. 1-2+9-11; LLP. 39-41; PP. 7; MDR. 12-14; DLR. 23-24; SLR. 36-37; ILR. 34-36; VLR. 20-22; MVR. 13-15.

Proportional measurements. Head 4.2-4.5 in SL; predorsal 2.8-3.0; pectoral fin 4.4-5.5; pelvic fin 9.8-14.0; caudal fin 7.1-8.3. Snout 3.3-3.6 in HL; orbit diameter 2.6-2.8; interorbital width 6.4-8.5; dorsal fin 2.2-2.6; anal fin 2.3-2.8. Body width 0.8-1.0 in its depth. Width of caudal peduncle 0.8-1.0 in its depth. Pelvic-anus length 7.5-8.5 in pelvic-anal length.

Body elongate, slender. Head moderate in size, somewhat depressed. Postocular and parietal spines present. Two spines on infraorbital ridge; one on lachrymal; one on second infraorbital. Free lachrymal margin smooth, without spine. Preopercular spines two, without a supplementary spine. Nasal bone with an upturned spine. A rostral plate with seven points; one dorsally, two dorsolaterally, two ventrolaterally, two laterally. Lower jaw included in upper one. Two barbels on posterior corner of maxillary. One or two tiny barbels on mandible. Eye moderate in size, with a row of bony tubercles. Gill membranes united, joined to isthmus, without free fold. Villiform teeth on jaws, prevomer and palatine.

Two dorsal fins well separated, its distance 4.2-8.7 in HL. Lower pectoral fin rays exerted. Pelvic fin short. Anal fin originating below between first dorsal end and second dorsal origin.

Sharp spines on dorsolateral, middorsal, supralateral, and infralateral plates.

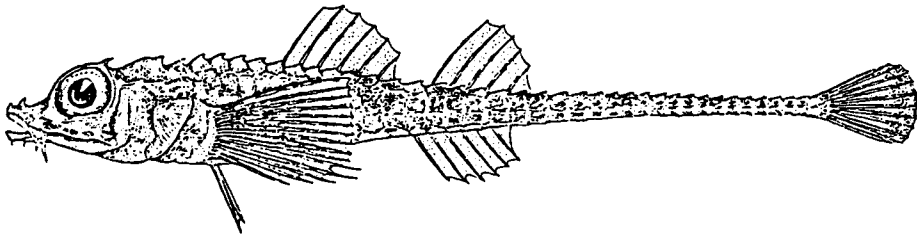

Fig. 29. *Bathyagonus alascanus* (Gilbert). Taken from Hart, 1973.

Ventrolateral and midventral plates with a blunt spine. One paired plates and three to four single plates on midline of prepelvic area. Two or three plates on cheek region.

Color. In preserved specimens, body brown, darker dorsally, paler ventrally. Five or six dark crossbands on body side. Dark bars on dorsal, pectoral and caudal fins. Pelvic and anal fins pale. Peritoneum pale.

Sexual dimorphism. Not examined.

Distribution. Northern California through Washington, British Columbia, Alaska, to the Bering Sea, depth 18-252 m.

Remarks. *Bathyagonus alascanus* is a small-sized species, living in shallow waters off the western coast of North America.

Materials. 8 specimens, 77.1-95.2 mm SL. HUMZ 17451-17454 and 17456-17459, Burrard Inlet, Vancouver, 26 February 1934.

Bathyagonus infraspinus (Gilbert, 1904)

Fig. 30.

Xenertmus infraspinus Gilbert, 1904, pp. 262-263, pl. 27 (original description; type locality, off Cape Flattery, Washington, depth 77 fms).

Asterotheca infraspinata Gilbert, 1915, p. 344 (key).

Bathyagonus infraspinus. Fitch, 1973, p. 817.

Diagnosis. In addition to the characters in the key, *B. infraspinus* is distinguished from other species of *Bathyagonus* in having the following characters: first preopercular spine without a supplementary spine; two short barbels on mandible.

Counts. D. V-VII-5-6; A. 6-8; P1. 15; P2. I, 2; C. 6+5; Br. 6; V. 39; Gr. 1+10; LLP. 38-39; PP. 6-7; MDR. 14-15; DLR. 21-23; SLR. 35-36; ILR. 34-35; VLR. 18-19; MVR. 16.

Proportional measurements. Head 4.1-4.3 in SL; predorsal 2.7-2.8; pectoral fin 4.7-5.9; pelvic fin 9.1-13.0; caudal fin 7.4-7.5. Snout 3.4-3.8 in HL; orbit diameter 2.6-3.0; interorbital width 7.5-10.0; dorsal fin 2.5-2.8; anal fin 2.5-2.8. Body width 0.8-0.9 in its depth. Width of caudal peduncle 0.7-0.9 in its depth. Pelvic-anus length 4.6-5.4 in pelvic-anal length.

Body slender, tapering to caudal peduncle. Head moderate in size, slightly depressed. A postocular spine present. Two spines on parietal; posterior one large and stout. A posttemporal spine present. Three spines on infraorbital ridge; one on lachrymal; one on first infraorbital; one on second infraorbital. Free lachrymal margin spinous. Preocular spines three. Nasal bone with a spine, attached to each other. A rostral plate with six points; one dorsally, two dorsolaterally, two ventrolaterally, one anteroventrally. Interorbital concave. Three spinous plates below infraorbital. Snout short, pointed. Premaxillary beyond snout tip. Jaws equal. Two barbels on maxillary. Maxillary reaching in front of anterior margin of orbit. Two short barbels on mandible. A row of tubercles on eyeball. Eye large. Gill membranes united and fused with isthmus, ending as a very narrow free fold. Villiform teeth on jaws, prevomer and palatine.

Two dorsal fins well separated, 5.1-8.7 in HL. Anal fin originating at just below first dorsal end. Pectoral fin with a shallow notch. Caudal fin round.

Sharp spines on dorsolateral, middorsal, supralateral and infralateral plates.

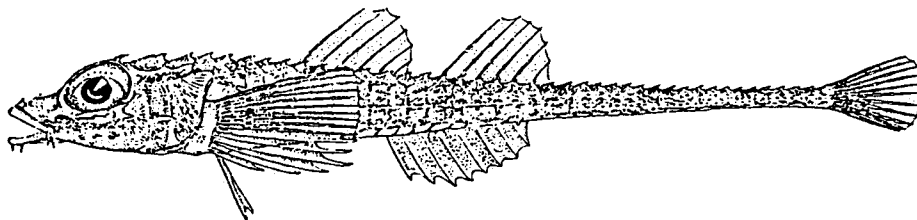

Fig. 30. *Bathyagonus infraspinatus* (Gilbert). Taken from Hart, 1973.

Spines on ventrolateral plates sharp anteriorly, blunt posteriorly. Middorsal plates nonspinous. Chest tightly covered with nonspinous plates. Pectoral base with a row of tiny spinous plates. Prepectoral area well covered with bony plates. Gular, gill membranes with nonspinous plates. Some plates surrounding anus.

Color. In preserved specimens, body brown, darker dorsally, paler ventrally. Dark blotches on body. Dorsal, pectoral and caudal fins pale, with dark bars. Anal and pelvic fins pale. Mouth, gill cavity, and peritoneum pigmented.

Sexual dimorphism. Not examined.

Distribution. Northern California, Washington, British Columbia, to Bering Sea.

Remarks. *Bathyagonus infraspinatus* is living in shallow waters with a sandy mud bottom.

Materials. 5 specimens, 77.8-98.0 mm SL. CAS 15149, 47°49.7'N, 124°49.3'W, depth 50 m, off Oregon, 19 August 1972; HUMZ 17470-17471, 17473-17474, Burrard Inlet, Vancouver, Canada, 26 February 1934.

Genus *Xenertmus* Gilbert, 1890

Xenochirus Gilbert, 1890, p. 90 (type species, *Xenochirus triacanthus* Gilbert; preoccupied by *Xenochirus* Gloger, 1841).

Xenertmus Gilbert in Jordan, 1903, p. 360 (type species, *Xenochirus triacanthus* Gilbert).

Xenopyxis Gilbert, 1915, p. 396 (type species, *Xenertmus latifrons* Gilbert).

External diagnosis. *Xenertmus* is distinguished from other genera of the family Agonidae in having the following characters: two dorsal fins; no barbel on snout tip; short nasal tube never reaching upper jaw; nasal bones attached to each other anteriorly; an enlarged rostral plate with one upturned spine; no ethmoidal spine; maxillary with one or two barbels at its posterior corner; cirri on mandible; gill membranes united, fused with isthmus, with a free fold or lacking; six branchiostegal rays; a pair of shallow occipital pits; 5-7 dorsal spines; 5-8 anal rays.

Internal diagnosis. *Xenertmus* differs from other genera of Agonidae in possessing the following osteological characters: an infraorbital shelf; ascending process of premaxillary shorter than alveolar process; interhyal shorter than epihyal; urohyal with a lateral keel; no basihyal; three basibranchials; exoccipital slightly exposed; three actinosts on pectoral girdle; two postcleithra; no pleural rib; one epural.

Remarks. The genus *Xenertmus* contains four species, *X. triacanthus*, *X.*

latifrons, *X. leiops*, and *X. ritteri*. These species are confined to the west coast of North America.

Key to the species of *Xenertmus*

- 1a. Two or more barbels present at posterior corner of maxillary. 2.
- 1b. One barbel present at posterior corner of maxillary. 3.
- 2a. Cheek plate present. Pectoral fin ray 14 or less. *X. triacanthus*
- 2b. Cheek plate absent. Pectoral fin ray 16 or more. *X. ritteri*
- 3a. Dermal tubercles on eye ball present. Lateral line plate 42 or less. Mid-dorsal plate 16 or less. Vertebrae 42 or less. *X. latifrons*
- 3b. Dermal tubercles on eye ball absent. Lateral line plate 44 or more. Mid-dorsal plate 17 or more. Vertebrae 44 or more. *X. leiops*

Xenertmus triacanthus (Gilbert, 1890)

Fig. 31.

Xenochirus triacanthus Gilbert, 1890, p. 91 (original description; type locality, off coast of California).

Xenertmus triacanthus. Gilbert, 1915, pp. 344, 352-353 (description; San Diego and Monterey Bay, depth 10-199 fms).

Diagnosis. In addition to the characters in the key, *X. triacanthus* is distinguished from other species of *Xenertmus* in having the following characters: no bony tubercle on eye ball; gill membrane with a narrow fold; 39-42 lateral line plates; body without dark bar.

Counts. D. VI-7; A. 6; P1. 12-13; P2. I, 2; C. 6+5; Br. 6; V. 42; LLP. 39-42; PP. 6-7; MDR. 15-16; DLR. 23-24; SLR. 38; ILR. 38; VLR. 21-22; MVR. 16-17.

Proportional measurements. Head 4.5-5.1 in SL; predorsal 3.0-3.3; pectoral fin 4.6-5.7; pelvic fin 11.2-11.9; caudal fin 8.8-9.8. Snout 3.2-3.6 in HL; orbit diameter 3.0-3.2; interorbital width 9.3-11.0; dorsal fin 2.1-2.2; anal fin 2.0-2.5. Body width 0.9 in its depth. Width of caudal peduncle 0.6-0.8 in its depth. Pelvic-anus length 14.5-15.3 in pelvic-anal length.

Head slightly depressed. A sharp postocular spine present. Two spines on parietal. Posttemporal ridge ending as a spine. A spine on second infraorbital bone. Infraorbital ridge beginning with a small knob, ending as a spine. Free lachrymal margin smooth. Preopercular spines two; one upper corner, one lower corner. Nasal with a spine and attached to each other. A rostral plate with three points; one directed posterodorsally, other two laterally. Infraorbital concave. Three nonspinous bony plates below infraorbital. Snout moderate in size, pointed. Jaws equal never beyond snout. Two barbels on maxillary. Two or three short barbels on mandible. Maxillary end reaching anterior margin of orbit. Eye large, without bony tubercles. Gill membranes united and widely fused with isthmus, with a very narrow fold. Small nonspinous bony plates on gular region and united gill membranes. Villiform teeth on jaws, prevomer and palatine.

Dorsal fins well separated, 3.1-4.6 in HL. Anal fin originating just below second dorsal origin. Caudal fin truncate. Pectoral fin with a notch. Lower four rays slightly thickened.

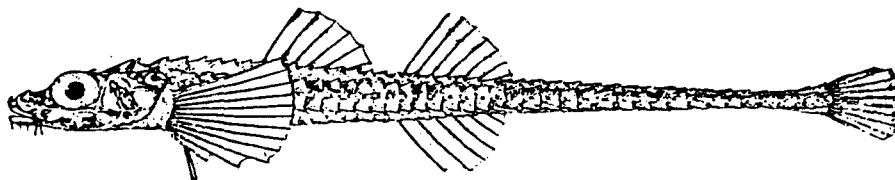

Fig. 31. *Xenertmus triacanthus* (Gilbert). Taken from Jordan and Evermann, 1900.

Sharp spines on plates of dorsolateral, middorsal, supralateral, infralateral and ventrolateral rows. Plates of midventral row nonspinous. Breast tightly covered with nonspinous plates. Pectoral fin base without plate. Anus plates present.

Color. In preserved specimens, body brown, darker dorsally, paler ventrally. All fins pale. Mouth cavity pale. Gill cavity with many dark pigments. Peritoneum dark.

Distribution. Near San Diego through southern and northern California, to Oregon and Washington, depth 73-373 m.

Materials. 4 specimens, 135.0-149.5 mm SL. CAS 14270 (3 specimens), 36°48'30"N, 122°07'15"W, depth 135 m, Monterey Bay, California, 22 December 1937; HUMZ 50374, off Catalina I., California, 19 April 1974.

Xenertmus latifrons (Gilbert, 1890)

Fig. 32.

Xenochirus latifrons Gilbert, 1890, pp. 92-93 (original description; type locality, coast of Oregon and San Diego, depth 61-158 fms).

Xenertmus latifrons. Gilbert, 1915, pp. 345-347 (description; San Diego to Monterey Bay, depth 11-199 fms).

Xenopyxis latifrons. Jordan, Evermann and Clark, 1930, p. 396 (listed).

Diagnosis. In addition to the characters in the key, *X. latifrons* is distinguished from other species of *Xenertmus* in having the following characters: gill membrane with a narrow fold; 14-15 pectoral fin rays; 36-38 supralateral plates; 14-16 midventral plates; 6-8 dark bands on lateral side of body; dorsal fins with a dark margin.

Counts. D. VI-VII-6-7; A. 7-8; P1. 14-15; P2. I, 2; C. 6+5; Br. 6; V. 41-42; Gr. 1-2+0-1+12-15; LLP. 39-42; PP. 6-7; MDR. 14-16; DLR. 22-24; SLR. 36-38; ILR. 35-38; VLR. 20-23; MVR. 14-16.

Proportional measurements. Head 4.6-5.3 in SL; predorsal 3.1-3.5; pectoral fin 5.3-6.4; pelvic fin 10.2-16.2; caudal fin 8.2-9.5. Snout 3.4-3.7 in HL; orbit diameter 2.5-2.9; interorbital width 7.8-10.9; dorsal fin 2.0-2.5; anal fin 1.9-2.3. Body width 0.9-1.0 in its depth. Width of caudal peduncle 0.6-0.9 in its depth. Pelvic-anus length 6.6-13.0 in pelvic-anal length.

Body elongate. Head slightly compressed, pointed in lateral view. A sharp spine on upper corner of orbit. A sharp parietal spine with a small supplementary spine at its anterior base. Posttemporal with a spine directed posteriorly. Snout short, pointed, and slightly beyond upper jaw. Mouth small, terminal. Lower jaw slightly included in upper jaw. Maxillary reaching anterior margin of pupil. A

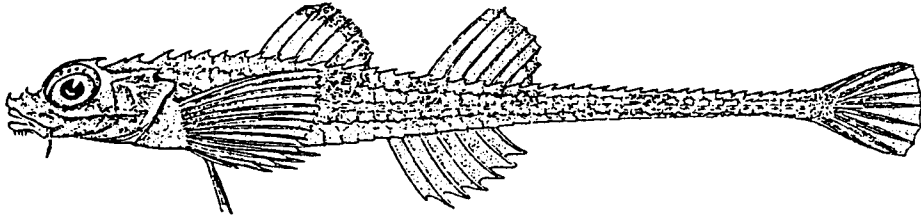

Fig. 32. *Xenertmus latifrons* (Gilbert). Taken from Hart, 1973.

short barbel on posterior corner of maxillary. Two small cirri on mandible. Nasal bone with a sharp spine directed posterodorsally, attached to each other at anterior end. A rostral plate triangular in front view, with a large recurved spine at its anterior tip. Interorbital narrow, concave. Eye large, with a row of bony tubercles consisted of three to five small spines on its upper part. Two spines on second infraorbital bone. Free lachrymal margin smooth, without spines. No plate below infraorbital bones. Preopercular spines three, uppermost large and directed posteriorly, other two indistinct. Gill membranes united, widely fused with isthmus, with a free posterior fold narrowly. Nonspinous small bony plates on united gill membrane. Villiform teeth on jaws, prevomer and palatine. Unbranched or rarely branched two short barbels on dentary, one on symphysial-pore margin, one on second dentary-pore margin.

Dorsal fins two; interdorsal distance variable 2.8-7.4 in HL. Anal fin originating slightly before second dorsal origin. Caudal fin round. Pectoral fin with a shallow notch, lower rays thickened. Pelvic fin short.

Spines of dorsolateral, middorsal, supralateral, and infralateral plates present. Ventrolateral plates with a blunt spine. Midventral plates nonspinous. Breast loosely covered with small nonspinous plates. Small plates surrounding anus. Prepectoral area covered with small plates. Lateral line plates nonspinous, except for first two or three plates with a spine.

Color. In preserved specimens, body brown, darker dorsally, paler ventrally, with six to eight indistinct dark bands on its side. Dorsal, anal, pectoral and pelvic fins pale. Dorsal fins with a dark band marginary. Caudal fin dark, paler at middle. Mouth cavity pale. Gill cavity and peritoneum dark.

Sexual dimorphism. In male, pelvic fin length (10.2-11.8 in SL) longer than those in female (14.0-16.2).

Distribution. Ensenada, southern California, to Burrard Inlet, British Columbia, depth 72-360 m.

Remarks. *Xenertmus latifrons* is confined to a region extending from southern California to British Columbia, and is fairly common in southern British Columbian waters (Clemens and Wilby, 1946).

Materials. 16 specimens, 114.4-146.3 mm SL. HUMZ 17460-17461, Strait of Georgia, off Gabriola I., B.C., Canada, 2 February 1955; HUMZ 17467-17469, off Denman I., Strait of Georgia, B.C., Canada, 18 October 1953; HUMZ 50371-50373, off Huntington Beach, Los Angeles, California, 3 March 1974; HUMZ 52017, 52020-52026, Numulcamis Bay, Trevor

Channel, Vancouver I., B.C. Canada, 4 May 1973.

Xenertmus leiops Gilbert, 1915

Fig. 33.

Xenertmus leiops Gilbert, 1915, pp. 345 and 348-350, pl. 17, fig. 11 (original description; type locality, off Catalina I., southern California, depth 178-195 fms).

Xenopyxis leiops. Jordan, Evermann and Clark, 1930, p. 396.

Diagnosis. In addition to the characters in the key, *X. leiops* is distinguished from other species of *Xenertmus* in having the following characters: no cheek plate; gill membrane with a narrow fold; 14 pectoral fin rays; 41 supralateral plates; 18-19 midventral plates; 9 dark blotches on lateral side of body; dorsal fins with a dark margin.

Counts. D. VI-VII-8; A. 7; P1. 14; P2. I, 2; C. 6+5; Br. 6; V. 45; Gr. 1+10; LLP. 44-45; PP. 6-7; MDR. 18; DLR. 24-25; SLR. 41; ILR. 39-41; VLR. 22-24; MVR. 18-19.

Proportional measurements. Head 4.8-5.0 in SL; predorsal 3.3-4.1; pectoral fin 5.2-5.4; pelvic fin 11.6-11.7; caudal fin 9.0-10.5. Snout 3.0-3.2 in HL; orbit diameter 2.6-2.8; interorbital width 11.0-11.5; dorsal fin 2.3-2.4; anal fin 2.2-2.3. Body width 1.0-1.1 in its depth. Width of caudal peduncle 0.7-0.8 in its depth. Pelvic-anus length 9.8-13.0 in pelvic-anal length.

Body slender. Head moderate in size, slightly compressed. A postocular spine present. Parietal ridge with two spines. Posttemporal ridge ending as a spine. A spine on second infraorbital bone. Snout pointed, slightly beyond upper jaw. Mouth small. Lower jaw slightly included in upper one. Maxillary reaching anterior margin of pupil. A short barbel on posterior corner of maxillary. Tiny cirri on margin of anterior two mandible pores. Eye large, without bony tubercle. Free lachrymal margin smooth. Interorbital concave. No plate on cheek. Nasal bones with a sharp spine directed posterodorsally, attached to each other at anterior tip. A rostral plate with an upright spine. Preopercular spine one, directed posteriorly. Gill membranes united and widely fused with isthmus with a posterior narrow fold. Three small plates on united gill membranes. Villiform teeth on jaws and palatine. An oval patch of teeth on prevomer.

Two dorsal fins separated each other in short distance, 4.6-4.7 in HL. Anal origin slightly before second dorsal origin. Caudal fin truncate. Pectoral fin with a shallow notch. Lower five pectoral fin rays thickened. Pelvic fin short.

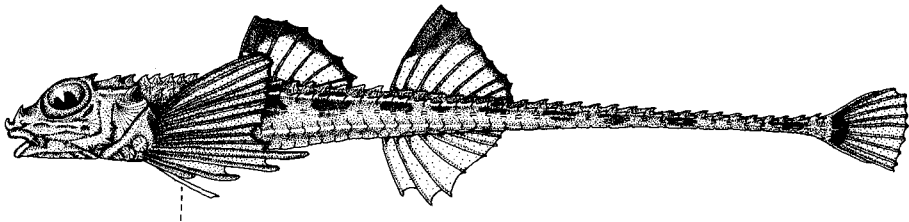

Fig. 33. *Xenertmus leiops* Gilbert: HUMZ 40419, 217.8 mm SL.

A sharp spine on dorsolateral, middorsal, supralateral, and infralateral plates. Plates of ventrolateral row with a blunt spine. Plates of midventral row and prepelvic area without spine. Breast loosely covered with plates. Anus surrounded by nonspinous plates. Prepectoral area without plate. First three lateral line plates with a spine, other plates lacking a spine.

Color. In preserved specimens, head and body brown, darker dorsally, paler ventrally. Lateral side of body with nine dark blotches. Dorsal fins pale with a dark margin. Anal and pelvic fins pale. Pectoral fin pale with a dark blotch at its base. Caudal fin pale with a dark blotch at its base. Mouth and gill cavities, and peritoneum dark.

Distribution. Santa Catalina Is. to La Parouse Bank (51°15'N, 129°55'W), off Vancouver Is., depth 60-400 m.

Remarks. *Xenertmus leiops* has been previously recorded from Santa Catalina Is. to Strait of Juan de Fuca, British Columbia (Miller and Lea, 1972). Its distributional range is now known to extend northward to 51°15'N.

Materials. 2 specimens, 213.6-216.3 mm SL. HUMZ 40419, 51°15'N, 129°55'W, depth 279 m, by otter trawl, 13 February 1970; HUMZ 51925, 48°22.8'N, 126°05.3'W, depth 302 m, La Parouse Bank, off Vancouver Is., 11 September 1972.

***Xenertmus ritteri* Gilbert, 1915**

Fig. 34.

Xenertmus ritteri Gilbert, 1915, pp. 345, 350-352, pl. 17, fig. 10 (original description, San Diego, depth 176-227 fms).

Xenopyxis ritteri. Jordan, Evermann and Clark, 1930, p. 396.

Diagnosis. In addition to the characters in the key, *X. ritteri* is distinguished from other species of *Xenertmus* in having the following characters: a row of spine lets on eye ball; gill membranes with a narrow fold; 41 lateral line plates; about 8 indistinct narrow dark cross bars on the back; dorsal fins with a black bar at base and margin.

Counts. D. V-VII-6-7; A. 6-7; P1. 16-17; P2. I, 2; V. 40-41; LLP. 41; PP. 6.; MDR. 14-15; SLR. 40-41; ILR. 36-38; MVR. 14-16.

Proportional measurements. Head 4.1 in SL; predorsal 3.1; pectoral fin 5.9; pelvic fin 11.1; caudal fin 7.7. Snout 3.8 in HL; orbit diameter 3.3; interorbital width 9.1; dorsal fin 2.0.

Distribution. Upper Gulf of California; Cedros Island, Baja California to

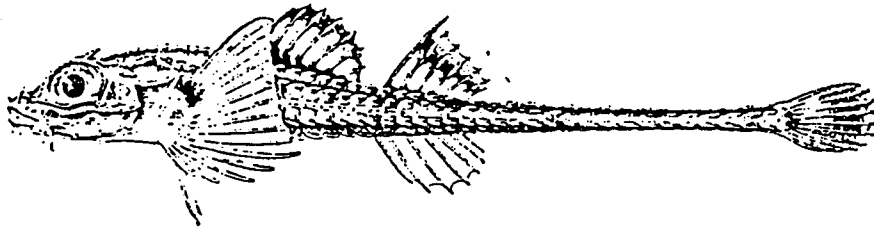

Fig. 34. *Xenertmus ritteri* Gilbert. Taken from Gilbert, 1915.

Malibu, depth 180-360 m.

Remarks. Examples of *Xenertmus ritteri* were not available for study. The above description was taken from Gilbert (1915), Miller and Lea (1972), and Leipertz (1985).

Genus *Odontopyxis* Lockington, 1880

Odontopyxis Lockington, 1880, p. 326 (type, *Odontopyxis trispinosa* Lockington).

External diagnosis. *Odontopyxis* is distinguished from other genera of the family Agonidae in having the following characters: two dorsal fins; dorsal fin with 5-6 spines and 6-7 rays; 6 anal fin rays; 14 pectoral fin rays; no snout barbel; nasal tube never reaching upper jaw; nasal bones attached to each other; a rostral plate with an ascending spine; nasal bone equal to upper jaw; absence of ethmoidal and parietal spines; lower jaw included in upper one; a barbel on maxillary end; no barbel on lower jaw; teeth on palatine and prevomer; six branchiostegal rays; a pair of occipital pits just behind head; gill membranes broadly united isthmus; interdorsal distance 3.6-3.9 in HL; 38 vertebrae; 5-7 predorsal plates; 38-39 lateral line plates.

Internal diagnosis. *Odontopyxis* differs from other genera of Agonidae in possessing the following osteological characters: attachment between lachrymal and nasal bone; an infraorbital shelf; an ascending process of premaxillary shorter than alveolar process; short interhyal; ventral keel of urohyal; no basihyal; three basibranchials; exposed exoccipital; three actinosts on pectoral girdle; two postcleithra; no postpelvic spine; no pleural rib; posterior insertion of dorsal pterygiophore; posterior insertion of anal pterygiophore; one epural.

Remarks. This genus is represented by a single species, *O. trispinosa*, distributed along the west coast of North America.

Odontopyxis trispinosa Lockington, 1880

(Japanese name: Mame-tokubire)

Fig. 35.

Odontopyxis trispinosus Lockington, 1880, pp. 328-330 (original description; type locality, markets of San Francisco, coast of Alaska).

Podothecus trispinosa. Jordan and Gilbert, 1881c, p. 454 (locality, San Francisco, Santa Barbara).

Podothecus trispinosus. Bean, 1882, p. 248 (locality, Sitka).

Odontopyxis trispinosa. Fitch, 1966, pp. 121 and 123 (key).

Diagnosis. See account of the genus *Odontopyxis*.

Counts. D. V-VI-6-7; A. 6; P1. 14; P2. I, 2; C. 6+5; Br. 6; V. 38; LLP. 38-39; Gr. 1+7; PP. 5-7; MDR. 14; DLR. 21; SLR. 34-35; LLR. 35; VLR. 20; MVR. 15.

Proportional measurements. Head 4.8-4.9 in SL; predorsal 2.8-3.0; pectoral fin 5.9-6.1; pelvic fin 15.4-15.5; caudal fin 7.5-7.9. Snout 3.6 in HL; orbit diameter 3.4-3.5; interorbital width 6.5-8.1; dorsal fin 2.2-2.6; anal fin 2.4-2.6. Body width 0.8 in its depth. Width of caudal peduncle 0.9-1.0 in its depth. Pelvic-anus length 4.7-6.2 in pelvic-anal length.

Body elongate, slightly depressed. Head moderate in size, depressed. A su-

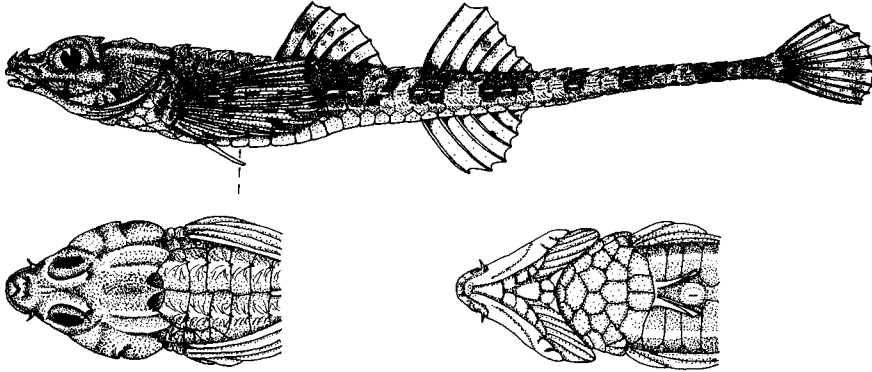

Fig. 35. *Odontopyxis trispinosa* Lockington: BCMP 978-144, 63.3 mm SL.

praocular spine recurved posterodorsally on upper posterior corner of orbit. A pair of deep pits just behind head. Snout pointed, without ethmoidal spine. Nasal bone with a posterior recurved spine, attached to each other at anterior end. A rostral spine sharp, directed posterodorsally. Nasal tube very short, never reaching upper jaw. Mouth small, subterminal. Upper jaw never reaching anterior margin of orbit. Lower jaw included in upper one. A barbel on maxillary end long, 5.1-5.3 in orbit diameter. Eye large, with a row of tubercles on upper part. Interorbital region concave. No spine on infraorbital bones. Lachrymal with a spine on midlateral side. Free lachrymal margin smooth. Preopercular spines three, blunt. Opercle with a serrated margin. Teeth in bands on jaws, palatine and prevomer. Gill membranes united with isthmus.

Dorsal fins well separated into two, its distance 3.6-3.9 in HL. Pectoral fin reaching below third dorsal spine. Anal fin far behind, just below second dorsal fin. Anus situated behind pelvic fin base in short distance. Caudal fin round.

Body tightly covered with bony plates. Plates of middorsal, dorsolateral and supralateral rows with a spine. Other plates smooth, without spine. Subpectoral plate one. Infraorbital plate two. Chest, gular, isthmus and pectoral fin basal regions covered with plates. Anus surrounded by tiny tubercles.

Color. In preserved specimens, body brown, with eight dark cross bands. Head darker dorsally, paler ventrally. A dark streak from tip of snout to anterior margin of orbit. All fins pale. Dorsal, anal and pectoral fins with dark spots. Caudal fin pale, dark basally, posterior part with a dark band.

Sexual dimorphism. Not examined.

Distribution. Coast of North America, from Cedros Islands, Baja California to southern East Alaska.

Remarks. *Odontopyxis trispinosa* usually inhabits sandy or rocky bottoms in 10-100 m, but has been taken by trawl as deep as 373 m.

Materials. 3 specimens, 60.0-63.3 mm in SL. BCMP 978-144, Shute Passage between Piers I. and Portland I., near Saanic, Vancouver I., 15 May 1978; HUMZ 62266, Ueluelet, western Vancouver I., British Columbia, June-July 1909.

Genus *Ulcina* Cramer, 1896

Ulcina Cramer, in Jordan and Evermann, 1896, p. 449 (type, *Aspidophoroides olriki* Lütken).

External diagnosis. *Ulcina* is distinguished from all other genera of the family Agonidae in having the following characters: one dorsal fin; a sharp nasal spine directed posterodorsally; nasal bone never extending beyond upper lip, attached to each other at anterior end; a free nonspinous rostral plate; terminal small mouth; a barbel on maxillary end; no supralateral plate; 14-16 predorsal plates; 26-32 lateral line plates; 13-15 pectoral fin rays.

Internal diagnosis. *Ulcina* differs from other genera of Agonidae in possessing the following osteological characters: attachment between lachrymal and nasal bone; no infraorbital shelf; ascending process of premaxillary shorter than alveolar process; short interhyal; urohyal with lateral keel; no basihyal; three basibranchials; never exposed exoccipital; no attachment between entopterygoid and quadrate; no attachment between frontal and parasphenoid; three actinosts on pectoral girdle; two postcleithra; no postpelvic spine; no pleural rib; posterior insertion of dorsal pterygiophore; posterior insertion of anal pterygiophore; one epural.

Remarks. *Ulcina* was first proposed by Cramer (1896), as a new subgenus of agonid fishes, without comparison with *Aspidophoroides*. Later, Jordan et al. (1930) elevated *Ulcina* to generic level. The status of *Ulcina* is supported by a derived character, the absence of an attachment between the entopterygoid and quadrate.

Ulcina is represented by a single species, *U. olriki*, distributed in waters from the Bering Sea, through the Arctic Sea, to the northern North Atlantic.

Ulcina olriki (Lütken, 1876)

(Japanese name: Fujii-tokubire)

Fig. 36.

Aspidophoroides olriki Lütken, 1876, pp. 96, 384 and 385, 3 figs. (original description; type locality, Greenland; type in Copenhagen Museum).

Aspidophoroides guntherii Bean, 1885, p. 75 (original description; type locality, Alaska; holotype in USNM 37032).

Aspidophoroides olriki. Lütken, 1886, p. 120, figs. 1-3.

Aspidophoroides guntheri. Jordan, 1887, p. 113 (listed).

Ulcina olriki. Jordan, Evermann and Clark, 1930, p. 397.

Ulcina guntheri. Jordan, Evermann and Clark, 1930, p. 397.

Diagnosis. See account of the genus *Ulcina*.

Counts: D. 6-7; A. 5-7; P1. 13-15; P2. I, 2; C. 5+5; Br. 6; V. 37-39; LLP. 26-32; PP. 14-16; MDR. 11-14; DLR. 22-25; ILR. 34-37; VLR. 16-21; MVR. 11-18; prepelvic plate 1+2-3+1.

Proportional measurements. Head 3.7-4.2 in SL; predorsal 1.6-1.8; caudal fin 6.2-6.8; pectoral fin 3.6-4.6; pelvic fin 7.8-10.7. Snout 4.2-5.0 in HL; orbit diameter 3.2-3.9; interorbital width 4.6-5.6; depth of dorsal fin 2.0-2.3; depth of anal fin 2.3-2.9. Body width 0.7-0.8 in its depth. Width of caudal peduncle 1.1-1.4 in its depth. Pelvic-anus length 3.6-4.5 in pelvic-anal length. Length of anterior nasal flap 4.5-4.8 in orbit diameter.

Body short. Head broad and depressed. No barbel on head, except for

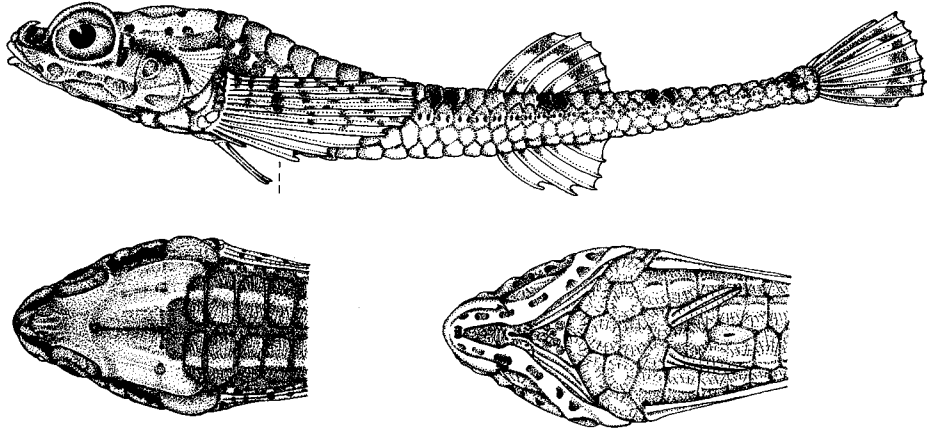

Fig. 36. *Ulcina olriki* (Lütken): HUMZ 69035, 49.0 mm SL.

maxillary end. A short barbel on maxillary end 4.5-4.8 in orbit diameter. Maxillary beyond anterior margin of orbit in short distance. Jaws about equal. Eye fairly large. Interorbital slightly concave.

Dorsal fin one, without spiny ray. Dorsal fin originating at 15-16th bony plates of dorsolateral row. Anal fin originating slightly behind of dorsal origin. Pectoral fin large, 3-6th rays longest, and gradually decreasing in its length toward to lower.

Body plates smooth, without spine. Plates of middorsal, dorsolateral, infraorbital, ventrolateral, and midventral rows present. Supralateral plates absent. One or two plates below infraorbital. Subpectoral plates small and irregularly arranged. Tiny bony plates surrounding around anus.

Color. In preserved specimens, body with four dark brown bands, darker dorsally, paler ventrally. Dorsal fin pale, with dark two bands. Pectoral fin pale, with dark spots. Anal and pelvic fins pale. Caudal fin dark brown, pale at posterior margin and center. Head pale ventrally. Transverse dark brown bands running on midlateral side of head. Peritoneum pale with pigments.

Sexual dimorphism. All specimens examined are female. I could not examine whether sexual dimorphism of the present species is present or absent.

Distribution. North Bering Sea, Arctic Sea, White Sea, and Hudson Bay.

Remarks. *Ulcina olriki* was originally described by Lütken (1876), as *Aspidophoroides olriki*, on the basis of specimens from Greenland. Bean (1885) later described specimens from Alaska, as *Aspidophoroides guntherii*, but they are clearly conspecific with *U. olriki*.

Materials. 6 specimens, 47-62 mm SL, from Bering Sea, by otter trawl. HUMZ 69034 and 69035, 63°45'N, 179°30'W, depth 55 m, 23 June 1973; HUMZ 69036, 64°45'N, 177°30'W, depth 65 m, 19 June 1973; 2 uncatalogued specimens, 63°15'N, 179°30'W, depth 70 m, 23 June 1973; one uncatalogued specimen, 63°45'N, 179°30'W, depth 55 m, 23 June 1973.

Genus *Aspidophoroides* Lacépède, 1801

Aspidophoroides Lacépède, 1801, p. 227 (type, *Aspidophoroides traquebar* Lacépède = *Agonus monopterygius* Bloch and Schneider).

Canthirhynchus Swainson, 1839, p. 181 (type, *Cottus monopterygius* Bloch).

External diagnosis. *Aspidophoroides* is distinguished from all other genera of the family Agonidae in having the following characters: one dorsal fin; a sharp nasal spine directed posterodorsally; nasal bone never extending beyond upper lip, attached to each other at anterior end; a free nonspinous rostral plate; terminal and small mouth; no barbel on maxillary end; no plate of supralateral row; 20-25 predorsal plates; 47-53 lateral line plates; 9-11 pectoral fin rays.

Internal diagnosis. *Aspidophoroides* differs from other genera of Agonidae in possessing the following osteological characters: attachment between lachrymal and nasal bone; no infraorbital shelf; ascending process of premaxillary shorter than alveolar process; short interhyal; urohyal with lateral keel; no basihyal; three basibranchials; no exposed exoccipital; attachment between entopterygoid and quadrate; attachment between frontal and parasphenoid; three actinosts on pectoral girdle; two posteleithra; no postpelvic spine; no pleural rib; posterior insertion of dorsal pterygiophore; posterior insertion of anal pterygiophore; one epural.

Remarks. *Aspidophoroides* is represented by a single species, *A. monopterygius*, widely distributed in waters from the northern North Pacific, through the Arctic Sea, to the northern North Atlantic.

Aspidophoroides monopterygius (Bloch, 1787)

(Japanese name: Tate-tokubire)

Fig. 37.

Cottus monopterygius Bloch, 1787, part V, p. 126, pl. 178, figs. 1 and 2 (original description; type locality, East Indies; type in Berlin Museum).

Cottus indicus Bonnaterre, 1788, p. 68 (type locality, East Indies).

Agonus monopterygius. Bloch and Schneider, 1801, p. 104.

Aspidophoroides tranquebar Lacépède, 1801, p. 228 (description).

Aspidophoroides monopterygius. Cuvier, 1829, p. 224 (description).

Canthirhynchus monopterygius. Swainson, 1839, p. 272 (listed).

Aspidophorus monopterygius. Bonaparte, 1846, p. 62 (listed).

Aspidophoroides bartoni Gilbert, 1895, p. 434 (original description; type locality, Aleutian Is. and Bristol Bay, type in USNM).

Diagnosis. See account of the genus *Aspidophoroides*.

Counts and proportional measurements. Counts and proportional measurements are shown in Table 6.

Body elongate, slender. Head depressed, triangular in dorsal view. No barbel on head. Lower jaw slightly inferior. Maxillary reaching anterior margin of orbit or not. Two to four plates below infraorbital bones. Tiny plates surrounding around anus.

Color. When fresh, body brownish dorsally, whitish ventrally, with five faint dark brown bands. Head brownish dorsally, whitish ventrally, with a transverse dark band. Dorsal fin rays brownish, last one or two rays whitish. Dorsal and anal fin membranes transparent, marginal parts whitish. Anal rays light brown.

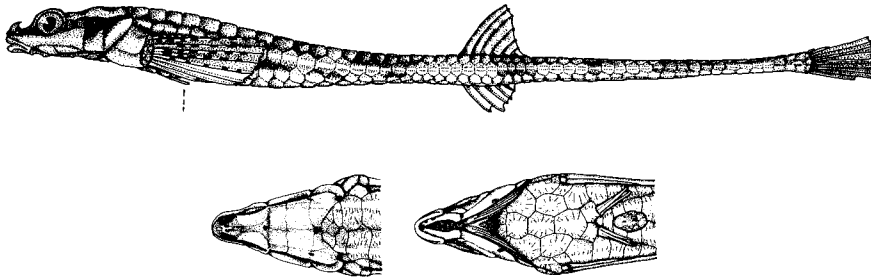

Fig. 37. *Aspidophoroides monopterygius* (Bloch): HUMZ 76642, 136.5 mm SL.

Pectoral fin with dark brown upper lobe and whitish lower lobe. Pelvic fin whitish. Caudal fin dark brown, with whitish margin.

In preserved specimens, body brown, with four faint dark bands, pale ventrally. Head dark dorsally, pale ventrally, with a transverse dark band. Dorsal fin dark. Anal and pelvic fins pale. Pectoral fin pale with dark dots at upper lobe. Caudal fin dark, with paler margin. Peritoneum pale, with pigments.

Sexual dimorphism. Pelvic fin longer in male than those in female as shown in Fig. 38.

Distribution. West Greenland and coast of Labrador, south to Cape Cod, straying to New Jersey, Arctic and Bering Seas, Okhotsk Sea, Japan Sea, Pacific coast of Japan south to choshi of Chiba Pref., and Gulf of Alaska.

Remarks. *Aspidophoroides monopterygius* was first described by Bloch (1787), as *Cottus monopterygius*, based on specimens from the East Indies. Gilbert (1896) later described specimens from the Aleutian Is. and Bristol Bay as a new species, *A. bartoni*, based on a comparison of specimens from the Bering and Atlantic seas. Since this time, *A. monopterygius* has been used for Atlantic and Arctic specimens,

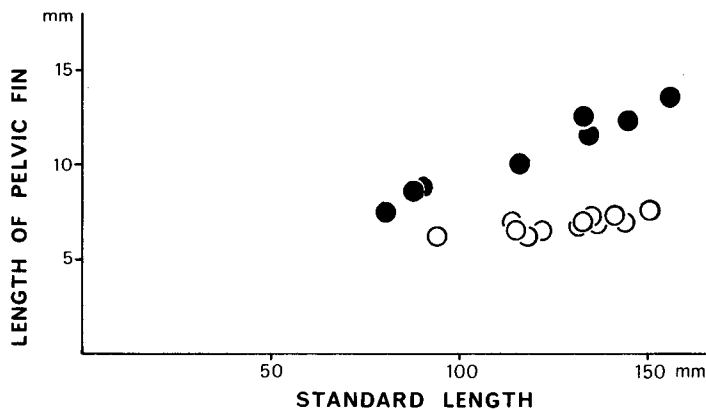

Fig. 38. Sexual dimorphism of the pelvic fin in *Aspidophoroides monopterygius*. Closed circle, male; open circle, female.

Table 6. Counts and proportional measurements of *Aspidophoroides monoptygius* from three regions, western North Pacific, Bering Sea and Atlantic Ocean.

Region	Western North Pacific	Bering Sea	Atlantic Ocean
Number of specimens	9	15	12
Standard length (mm)	116.6-156.4	80.2-144.2	95.0-148.0
Proportional measurements			
In standard length			
Head length	5.8-6.7	5.4-6.3	5.4-6.5
Predorsal length	1.8-2.0	1.7-1.9	1.8-2.0
Pectoral fin length	6.2-7.4	5.0-6.6	5.6-6.7
Pelvic fin length	10.9-23.1	10.1-20.6	9.2-20.7
Caudal fin length	9.4-10.9	8.3-11.6	7.2-9.7
In head length			
Snout length	4.0-4.7	3.9-4.5	4.2-4.8
Orbit diameter	3.5-4.3	3.3-4.0	3.4-4.0
Interorbital width	4.8-6.8	5.6-7.0	5.3-6.8
Dorsal fin rays length	1.9-2.4	2.0-2.4	1.8-2.1
Anal fin ray length	2.5-3.3	2.2-3.2	2.2-3.4
Body width in its depth	0.6-0.7	0.6-0.7	0.6-0.7
Width of caudal peduncle in its depth	0.8-1.2	0.9-1.3	1.0-1.3
Counts			
Dorsal fin rays	5-6	5-6	5-6
Anal fin rays	4-6	5-6	5-6
Pectoral fin rays	9	9-10	10-11
Pelvic fin rays	I, 2	I, 2	I, 2
Caudal fin rays	5+5	5+5	5+5
Vertebrae	52-54	50-54	48-52
Bony plates			
Lateral line plates	49-53	49-52	47-50
Predorsal plates	20-25	20-24	20-23
MDR	19-25	18-25	16-20
DLR	26-32	27-32	28-32
ILR	49-53	48-52	47-50
VLR	23-26	23-28	23-26
MVR	21-25	19-23	16-23

and *A. bartoni* for Pacific specimens. My studies have not disclosed any clear differences between these two groups (Table 6), and it is considered, therefore, that *A. bartoni* is a junior synonym of *A. monopterygius*.

Materials. 36 specimens, 80.2-156.4 mm SL, collected by otter trawl. HUMZ 2302, off Monbetsu, Okhotsk coast of Hokkaido, Japan, 6-7 September 1968; HUMZ 41528, off Kitami, Okhotsk coast of Hokkaido, Japan, September 1964; HUMZ 69029, 62°45'N, 179°30'E, depth 87 m, North Bering Sea, 23 June 1973; HUMZ 69190 and 69191, 42°21'N, 143°45'E, 196 m, Pacific coast of Hokkaido, Japan, 8 September 1977; HUMZ 75972, 42°52.4'N, 144°19.1'E, 180 m, off Kushiro, Pacific coast of Hokkaido, Japan, 14 July 1978; HUMZ 76450, 57°04.5'N, 161°49.2'W, 50-52 m, Bering Sea, 23 May 1978; HUMZ 76642, 58°07.3'N, 173°45.0'W, 117 m, Bering Sea, 12 July 1978; HUMZ 76645-76647, 58°07.3'N, 173°45.0'W, 117 m, Bering Sea, 12 July 1978; HUMZ 76826 and 76828, 56°33.5'N, 163°47.0'W, 78 m, Bering Sea, 21 May 1978; HUMZ 76847 and 76848, 56°35.0'N, 162°55.2'W, 77 m, Bering Sea, 21 May 1978; HUMZ 76879, 57°05.3'N, 162°46.6'W, 59 m, Bering Sea, 23 May 1978; HUMZ 77053, 58°52.4'N, 176°13.3'W, 130 m, Bering Sea, 24 June 1978; HUMZ 77230 and 77232, 57°21.1'N, 172°15.8'W, 111 m, Bering Sea, 14 July 1978; HUMZ 77389, 58°20.7'N, 174°12.1'W, 137 m, Bering Sea, 11 July 1978; HUMZ 81038, 45°28'00"N, 48°30'00"W, 229 m, Grand Banks, off Newfoundland, Atlantic Ocean, 17 September 1961; HUMZ 81039, 48°08'30"N, 52°02'00"W, depth 274 m, off Newfoundland, Atlantic Ocean, 2 June 1963; HUMZ 87436-87437, off Muroran, Hokkaido, 145 m, by trawl, 16 May, 1980; HUMZ 90654-90655, off Miyako (Miyako fish market), Iwate Pref., 23 April 1981, NMC 62-123, 45°28'N, 48°30'W, 229 m, Grand Banks, off Newfoundland, Atlantic Ocean, 17 September 1961; NMC 63-157, 48°08'30"N, 52°02'00"W, 274 m, off Newfoundland, Atlantic Ocean, 2 June 1963.

Genus *Anoplagonus* Gill, 1862

Anoplagonus Gill, 1862c, p. 167 (type, *Aspidophoroides inermis* Günther).

Angelogonus Lütken, 1898, p. 38 (type, *Angelogonus inermis* Günther).

External diagnosis. *Anoplagonus* is distinguished from other genera of Agonidae in having the following characters: no spinous dorsal fin; no nasal spine; nasal bones separated each other; no barbels on head; short nasal bone never extending beyond upper lip; a free nonspinous rostral plate; no bony plate of supralateral row; gill membrane free from isthmus.

Internal diagnosis. *Anoplagonus* differs from other genera of Agonidae in possessing the following osteological characters: attachment between lachrymal and nasal; no attachment between nasals; absence of infraorbital shelf; ascending process of premaxillary shorter than alveolar process; short interhyal; urohyal with a lateral keel; no basihyal; one or two basibranchials; never exposed exoccipital; attachment between frontal and parasphenoid; three actinosts on pectoral girdle; two postcleithra; no postpelvic spine; no pleural rib; posterior insertion of dorsal and anal pterygiophores; one epural.

Remarks. *Anoplagonus* is represented by two species, *A. inermis* and *A. occidentalis*. The former is found in the eastern North Pacific and Bering Sea, while the latter is confined to the western North Pacific (Kanayama and Maruyama, 1979).

Key to the species of *Anoplagonus*

- 1a. One pair of prepelvic bony plates. Number of middorsal plates less than 13.
Number of vertebrae less than 43. *A. inermis*
- 1b. Two to three pairs of prepelvic bony plates. Number of middorsal plates

more than 12. Number of vertebrae more than 42. *A. occidentalis*

Anoplagonus inermis (Günther, 1860)
(Japanese name : Nametokubire)

Fig. 39.

Aspidophoroides inermis Günther, 1860, p. 524 (type locality, Vancouver I.; type in BMNH).

Anoplagonus inermis. Gill, 1862c, p. 167 (synonymy).

Aspidophoroides (Angelogonus) inermis. Lütken, 1898, p. 38.

Diagnosis. See account of the characters in the key of *Anoplagonus*.

Counts. D. 6; A. 5; P1. 10-11; P2. I, 2; C. 6+5; Br. 6; V. 41-42; LLP. 41-42; PP. 19-20; MDR. 13; DLR. 25-27; ILR. 38-40; VLR. 22-25; MVR. 14-16.

Proportional measurements. Head 4.8-5.5 in SL; predorsal 1.7-1.8; caudal fin 8.0-9.4; pectoral fin 6.9-7.6; pelvic fin 11.1-16.2. Snout 3.8-4.3 in HL; orbit diameter 4.5-5.6; interorbital width 6.3-7.5; dorsal fin 2.1-2.8; anal fin 2.9-3.1. Body width 0.6-0.7 in its depth. Width of caudal peduncle 1.0-1.6 in its depth. Pelvic-anus length 6.8-7.8 in pelvic-anal length.

Head depressed and smooth. Mouth terminal, small. Lower jaw slightly beyond upper lip. Maxillary end reaching in front of anterior margin of orbit. Eye moderate in size. Interorbital slightly concave.

Dorsal fin one, originating at 20th or 21th bony plates of dorsolateral row. Anal fin just below dorsal fin. Pectoral fin moderate in size, second or third ray longest, and gradually decreasing in its length toward to lower.

Body plates smooth, without spine. Cheek plates seven or more. Axil plates tiny, 10 or more. Tiny nonspinous bony plates surrounding around anus. Pre-pelvic formula 1 (paired) + 3-4 (single) + 0-1 (paired).

Color. In preserved specimens, body dark brown, with six darker cross bands. Head dark dorsally, pale ventrally. Dorsal fin pale, dark at rear part. Pectoral fin pale, dark at basal and posterior parts. Anal and pelvic fins pale. Caudal fin dark, with a pale band at middle part.

Sexual dimorphism. Not examined.

Distribution. Aleutian Islands, eastern Bering Sea, along the Pacific coast of

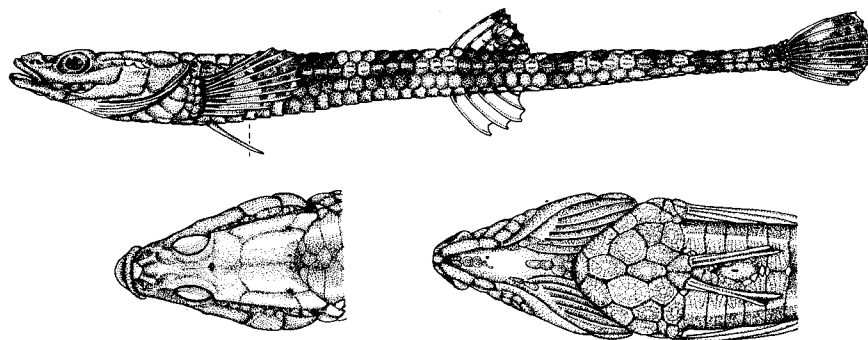

Fig. 39. *Anoplagonus inermis* (Günther): BCPM 978-102, 83.0 mm SL.

North America from Alaska Bay to Arena Cove (38°54'56"N, 123°43'26"W).

Remarks. *Anoplagonus inermis* is taken by trawl on rocky bottoms in 28-55 m.

Materials. 7 specimens, 74.6-91.8 mm SL. BCPM 978-102 (2 specimens), off James I., near Vancouver I., Canada, 5 April 1978; UBC 53-141 (4), 49°17'N, 123°10'W, from English Bay, Vancouver, British Columbia, Canada, October 1941; UBC 60-202 (1), 48°38'N, 123°17'W, off Mandarte I., near Victoria, British Columbia, Canada, 23 April 1959.

***Anoplagonus occidentalis* Lindberg, 1950**

(Japanese name: Nise-nametokubire)

Fig. 40.

Aspidophoroides inermis. Schmidt, 1904, p. 149 (locality, Kaiba I., north Japan Sea, and off Cape Pestschnuzoff, Korea).

Anoplagonus occidentalis Lindberg, 1950, p. 303, fig. 1 (type locality, off Cape Pestschnuzoff, Korea, Kaiba I., and off south of Cape Sufren, Tartar Strait).

Anoplagonus inermis. Soldatov and Lindberg, 1930, p. 307, (description; locality, Tartar Strait).

Diagnosis. See account of the characters in the key of *Anoplagonus*.

Counts. D. 4-6; A. 4-5; P1. 10; P2. I, 2; C. 6+5-6; Br. 6; V. 43-46; LLP. 42-44; PP. 20-22; MDR. 14-18; DLR. 26-29; ILR. 39-43; VLR. 22-25; MVR. 16-19.

Proportional measurements. Head 4.2-5.0 in SL; predorsal 1.7-1.8; caudal fin 8.3-9.7; pectoral fin 6.2-7.6; pelvic fin 10.4-18.0. Snout 3.4-3.8 in HL; orbit diameter 4.9-6.4; interorbital width 5.1-6.8; dorsal fin 3.1-3.8; anal fin 3.2-3.8. Body width 0.6-0.7 in its depth. Width of caudal peduncle 1.1-1.7 in its depth. Pelvic-anus length 6.0-8.4 in pelvic-anal length.

Head nonspinous, triangular in dorsal view. Mouth terminal. Jaws equal. Maxillary end never reaching anterior margin of orbit. Eye moderate in size. Interorbital slightly concave. Dorsal fin originating at 21th or 22th bony plates of dorsolateral row. Cheek plates small. Axil plates tiny. Bony plates surrounding around anus. Prepelvic formula 2-3+1-2+1 (Fig. 41).

Color. In preserved specimens, body dark brown, pale at anterior part of ventral surface. Head dark dorsally, pale ventrally. Snout and opercular regions dark. Dorsal, anal and pectoral fins pale with dark patches. Pelvic fin pale. Caudal fin dark with pale spots.

Sexual dimorphism. Not examined.

Distribution. Japan Sea, southern part of Okhotsk Sea, and off Pacific coast of Hokkaido to Miyako, Iwate Prefecture.

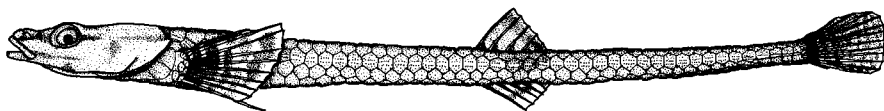

Fig. 40. *Anoplagonus occidentalis* Lindberg: HUMZ 72240, 63.5 mm SL.

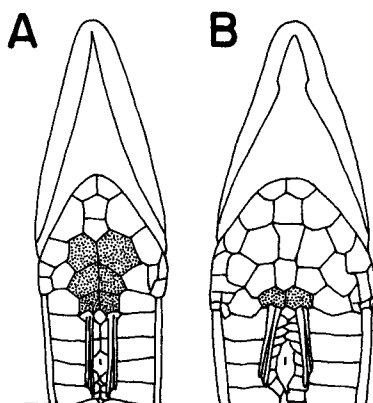

Fig. 41. Pairs of bony plates on ventral surface immediately in front of pelvic fins of (A) *Anoplagonus occidentalis* and (B) *A. inermis*.

Remarks. Kanayama and Maruyama (1979) previously recorded *Anoplagonus occidentalis* from the coast of Hokkaido. One of my examined specimens extends its distributional range of the Pacific coast of Japan south to Miyako, Iwate Prefecture.

Materials. 12 specimens, 45–95.2 mm SL. HUMZ 72240, 44°47'N, 143°00'E, depth 85 m, off Omu, Hokkaido, Japan, by small beam trawl, 25 August 1977; HUMZ 74845, 44°47'N, 142°59.5'E, 85 m, off Omu, Hokkaido, Japan, by small beam trawl, 25 August 1977; HUMZ 74846, 44°48'N, 143°01'E, 95 m, by small beam trawl, 25 August 1977; HUMZ 90653, off Miyako (Miyako fish market), Iwate Prefecture, by trawl, 23 April 1981; ZUMT 45634 (8 specimens), off southeastern coast of Kunashiri I., Kuril Is., August 1927.

4. Subfamily *Brachyopsinae* Jordan et Evermann, 1898

Brachyopsinae Jordan and Evermann, 1898, p. 2032.

Tilesininae Jordan and Starks, 1904, p. 576.

External diagnosis. *Brachyopsinae* are distinguished from other subfamilies of the family *Agonidae* in having the following characters: no enlarged rostral plate on snout tip; nasal bone never projecting forward beyond upper jaw; concave upper margin of orbit; gill membranes free from isthmus; superior mouth, lower jaw projecting forward beyond upper jaw; predorsal region never highly elevated.

Internal diagnosis. *Brachyopsinae* differ from other subfamilies of *Agonidae* in possessing the following osteological characters: absence of attachment between lachrymal and nasal; absence or rare presence of attachment between entopterygoid and metapterygoid; no rostral plate; smooth anterior free nasal margin; no forward projection of nasal; attachment between prevomer and ethmoid; small anterior process of ethmoid; concaved dorsal margin of orbit; four actinosts on pectoral girdle; no pore between actinosts; one tabular bone; inner pelvic keel; posterior insertion of dorsal pterygiophores; one spine on first dorsal pterygiophore; continuously spinous dorsal pterygiophores; one epural.

Remarks. The subfamily *Brachyopsinae* contains six genera, *Stellerina*, *Ghesnonia*, *Ocella*, *Tilesina*, *Brachyopsis*, and *Pallasina*.

Genus *Stellerina* Cramer, 1896

Stellerina Cramer, in Jordan and Evermann, 1896, p. 447 (type, *Brachyopsis xyosternus* Jordan et Gilbert).

External diagnosis. *Stellerina* is distinguished from other genera of the family Agonidae in having the following characters: two dorsal fins; a sharp nasal spine directed posteriorly; nasal bones never attached to each other; no rostral plate; upper jaw included in upper one; teeth on jaws, no teeth on palatine and prevomer; gill membranes free from isthmus; six branchiostegal rays; neither prickle nor bony plate on cheek; breast without enlarged bony plate.

Internal diagnosis. *Stellerina* differs from other genera of Agonidae in possessing the following osteological characters: large articular facet of lachrymal; no attachment between lachrymal and nasal; no infraorbital shelf; ascending process of premaxillary shorter than alveolar process; short interhyal; attachment between entopterygoid and metapterygoid; large ectopterygoid; plate-like urohyal, without lateral keel; attachment between prevomer and ethmoid; no basihyal; three basi-branchials; never exposed exoccipital; four actinosts on pectoral girdle; inner pelvic keel; two postcleithra; no pleural rib; one epural.

Remarks. The genus *Stellerina* is represented by a single species, *S. xyosterna*, confined to the western coast of North America.

Stellerina xyosterna (Jordan et Gilbert, 1881)

(Japanese name: Nise-saburou)

Fig. 42.

Brachyopsis xyosternus Jordan and Gilbert, 1881a, pp. 152-154 (original description; type locality, beach at Santa Cruz).

Agonus (Brachyopsis) annae Steindachner, 1881, pp. 254-255, pl. 6, figs. 1, 1a, 1b (description; locality, San Francisco).

Lapatonus xyosternus. Jordan and Gilbert, 1883, p. 955 (listed).

Stellerina xyosterna. Jordan and Evermann, 1896, p. 447 (locality, coast of California and Oregon).

Diagnosis. See account of the genus *Stellerina*.

Counts. D. VI-VIII-5-7; A. 8-9; P1. 17-19; P2. I, 2; C. 6+5; Br. 6; V. 35-37; LLP. 34-37; Cr. 2-3+15-16; PP. 6; MDR. 11-12; DLR. 22-23; SLR. 28-31; ILR. 28-31; VLR. 18-20; MVR. 11-13.

Proportional measurements. Head 4.4-4.8 in SL; predorsal 3.1-3.3; caudal fin 5.2-6.0; pectoral fin 4.2-4.6; pelvic fin 6.7-8.1. Snout 4.1-4.8 in HL; orbit diameter 3.8-4.2; interorbital width 5.2-7.3; longest dorsal fin 1.8-2.5; anal fin 2.0-2.4. Body width 0.8-1.0 in its depth. Width of caudal peduncle 0.7-0.8 in its depth. Pelvic-anus length 5.9-7.1 in pelvic-anal length.

Body depressed, highest at just behind head. Head moderate in size, depressed. A nasal spine directed posterodorsally and slightly medially. Snout paddle like shaped. Postocular with a blunt knob. A very low knob on parietal. Frontal-parietal ridge distinct, parallel to each other. Posttemporal ridge ending as a blunt posttemporal spine. Nasal bones never attached to each other. No rostral plate. Eye moderate in size, without bony tubercles. A second infraorbital spine with a supplementary knob at anterior base. Free lachrymal margin with three spines,

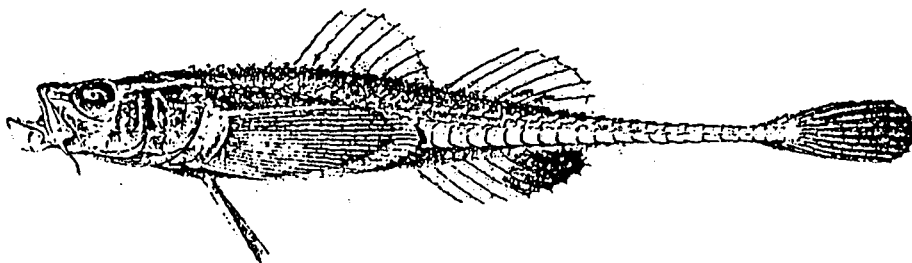

Fig. 42. *Stellerina xyosterna* (Jordan et Gilbert). Taken from Steindachner, 1881.

anterior one blunt and directed forward, posterior two sharp and projecting posterolaterally. Interorbital narrow, slightly concave. Lower jaw projecting forward beyond upper one. Maxillary with a long barbel (1.2-1.9 in orbit), reaching anterior margin of pupil. Preopercular spines four, uppermost large and directed posteriorly, second one at posteroventral corner of preopercle and directed posteroventrally, other two blunt and small. Villiform teeth on jaws, no teeth on prevomer and palatine. Gill membranes joined, free from isthmus.

Dorsal fins two, separated each other in short distance. Anal fin originating below near posterior end of first dorsal. Pectoral fin round, not reaching anal origin. Pelvic fin short, never reaching pectoral fin. Caudal fin round.

Body plates of middorsal, dorsolateral, supralateral, infralateral, ventrolateral and midventral rows, with a spine. Lateral line plates with a spine anteriorly, gradually reduced to posterior. No prickles on head, gill membrane, branchiostegal rays, and subpectoral region. Prickles on breast, gular region, and area between lateral line and infralateral plates. Infralateral plate originating below third spine of dorsal fin.

Color. In preserved specimens, body brown, dark dorsally, pale ventrally. Dorsal fins pale, dark at free margins. Anal fin pale, dark at posterior part. Pectoral fin pale, with a broad dark bar posteriorly. Caudal fin dark. Pelvic fin pale. Peritoneum, mouth and gill cavities pale.

Sexual dimorphism. Pelvic fin longer in male (6.7 in SL) than those in female (7.3-8.1).

Distribution. San Carlos Bay, Baja California to Strait of Juan de Fuca, British Columbia.

Remarks. Only a single male and six females could be examined for evidence of sexual dimorphism in *S. xyosterna*. The pelvic fin length appeared to exhibit a sexually dimorphic condition, as was observed in species of the subfamily Brachyopsinae.

Materials. 7 specimens, 80.4-116.2 mm SL. CAS 39116, Marin Co., California, depth 11 fathoms, 4 February 1972; CAS 39117, Moss Beach, San Mateo Co., California, 19 April 1957; CAS 39118, 44°39.8'N, 124°07.7'W, off Oregon, 52 m, 6 January 1967; LACM 30953-2, 37°41'N, 122°30'W, off San Francisco Bay, California, 6 fathoms, 3 March 1970.

Genus *Chesnonia* Iredale et Whitley, 1969

Occa Jordan and Evermann, 1898, p. 2043 (type species, *Brachyopsis verrucosus* Lockington; preoccupied by *Occa* Chesnon, 1835).

Chesnonia Iredale and Whitley, 1969, p. 45 (type species, *Brachyopsis verrucosus* Lockington).

External diagnosis. *Chesnonia* is distinguished from other genera of the family Agonidae in having the following characters: two dorsal fins; 8-9 dorsal fin spines; 7-8 dorsal fin rays; 11-13 anal fin rays; 14-15 pectoral fin rays; no snout barbel; nasal tube never reaching upper jaw; nasal bones never attached to each other; no rostral plate; nasal bone never beyond upper jaw; neither ethmoidal nor parietal spines; lower jaw projecting forward beyond upper jaw; maxillary with a short barbel; no barbel on lower jaw tip; teeth on palatine and prevomer; six branchiostegal rays; no occipital pit; interorbital width 4.9-5.2 in HL; interdorsal distance absent or separated in very short distance; 37-38 vertebrae; 7-8 predorsal plates; 36-39 lateral line plates; breast covered with enlarged plates and prickles.

Internal diagnosis. *Chesnonia* differs from other genera of Agonidae in possessing the following osteological characters: articular facet of lachrymal large; fifth infraorbital bone attached to second one; no attachment between entopterygoid and metapterygoid; large ectopterygoid; no basihyal; attachment between prevomer and ethmoid; anterior articular facet of prefrontal; no pore between actinosts on pectoral girdle; inner pelvic keel; no pleural rib; posterior insertion of dorsal and anal pterygiophores; first dorsal pterygiophore supporting one dorsal fin spine; one epural.

Remarks. The genus *Chesnonia* was proposed by Iredale and Whitley (1969), as a substitute name for *Occa* Jordan and Evermann (1898), which was preoccupied by one of birds, *Occa* Chesnon, 1835.

In the subfamily Brachyopsinae, *Chesnonia* is placed between *Stellerina* and *Ocella*. *Ocella* contains four species, *O. dodecaedron*, *O. iburia*, *O. kurosumai* and *O. kasawai*, and is characterized by a derived condition, absence of the ectopterygoid. *Chesnonia*, represented by a single species (*C. verrucosa*), differs from *Ocella* in having the primitive state, viz. a large ectopterygoid. *Chesnonia* is distinguished from *Stellerina* by a derived character, attachment between the entopterygoid and metapterygoid. Thus, the generic status of *Chesnonia* is validated.

Chesnonia verrucosa (Lockington, 1881)

(Japanese name: Ibo-saburou)

Fig. 43.

Brachyopsis verrucosus Lockington, 1881, pp. 60-63 (original description; type locality, Draker's Bay, north of San Francisco, 10 fms).

Agonus (Brachyopsis) barkani Steindachner, 1881, p. 253, pl. 5 (original description; type locality, San Francisco).

Leptagonus verrucosus. Jordan and Gilbert, 1883, p. 955.

Occa verrucosa. Jordan and Evermann, 1898, p. 2043-2044 (description; locality, Oregon coast).

Chesnonia verrucosa. Iredale and Whitley, 1969, p. 45.

Ocella verrucosa. Gruchý, 1970, pp. 1110-1114 (compared with *Ocella impi* and key).

Diagnosis. See account of the genus *Chesnonia*.

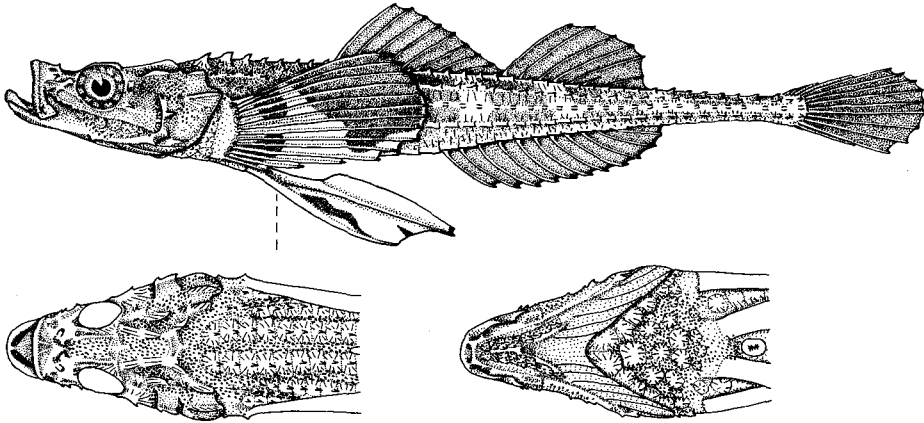

Fig. 43. *Chesnomia verrucosa* (Lockington): HUMZ 51923, 99.0 mm SL.

Counts. D. VIII-IX-7-8; A. 11-13; P1. 14-15; P2. I, 2; C. 6+5; Br. 6; V. 37-38; LLP. 36-39; Gr. 2+10-11; PP. 7-8; MDR. 5-7; DLR. 29-31; SLR. 34-35; ILR. 36-37; VLR. 25-28; MVR. 3-5.

Proportional measurements. Head 3.9-4.3 in SL; predorsal 2.8-2.9; caudal fin 5.5-5.9; pectoral fin 3.9-4.3; pelvic fin 3.8-8.2. Snout 3.8-4.3 in HL; orbit diameter 3.8-4.5; interorbital width 4.9-5.2; longest dorsal fin 2.1-2.6; anal fin 2.7-3.4. Body width 0.7-0.8 in its depth. Width of caudal peduncle 0.8-1.1 in its depth. Pelvic-anus length 4.6-6.2 in pelvic-anal length.

Head and body depressed. A sharp nasal spine directed posteromedially. Nasal bones attached to each other. Nasal tube short, never reaching upper jaw. Snout short. Postocular with a knob. A low knob on parietal. Frontal-parietal ridge distinct, converged each other posteriorly. Posttemporal ridge with three knobs, one on pterotic, one on tabular bone, one on posttemporal. Eye small, without bony tubercles. A sharp spine with a supplementary knob on second infraorbital. Free lachrymal margin with four spines, one directed anteriorly, other three ventroposteriorly. Interorbital region concave. Lower jaw projecting forward beyond upper jaw. Maxillary with a short barbel, reaching anterior margin of orbit. Preopercular spines four, uppermost spine large, directed posteriorly, with a tiny supplementary spine, other two small. Villiform teeth in bands on jaws, prevomer and palatine. Gill membranes united, free from isthmus.

Dorsal fins two, separated each other. Anal fin originating just below seventh dorsal spine, shorter than dorsal fins. Pectoral fin sublateral, round, never reaching anal origin. Pelvic fin in male long, reaching anal origin. Caudal fin round.

Body plates of middorsal, supralateral, dorsolateral and infralateral rows, with a spine. Plates of ventrolateral row with a sharp spine anteriorly, blunt posteriorly and reduced to a knob. Plates of midventral row smooth. Breast covered with enlarged bony plates and between them prickles scattered. Plates of lateral line row with a spine anteriorly, and lacking a spine posteriorly. Back of head, anterior dorsal of body, gular region, and base of first and second branchiostegal rays, covered

with prickles. Gular region scattered enlarged plates. Cheek covered with enlarged bony plates. Large plates and prickles around anus. Subpectoral region naked.

Color. In preserved specimens, head and body brown, dark dorsally, pale ventrally. Body with seven saddle like cross bands, one just behind head, two below first dorsal fin base, one between two dorsals, one below second dorsal, one on caudal peduncle, and one at caudal fin base. Anal fin dark, darker marginary. Dorsal fins with dark bands along free margin. Caudal fin dark. Pectoral fin pale, with dark blotches. Pelvic fin in male pale with irregular blotches on membrane, in female uniformly pale. Mouth, gill cavity and peritoneum pale.

Sexual dimorphism. In male, pelvic fin ray (3.8-3.9 in SL) longer than those in female (6.9-8.2).

Distribution. West of Pt. Montara to Shelikof of Alaska, west coast of North America.

Remarks. Elongation of the pelvic fin in male *Chesnonia verrucosa* is more extreme than in any other agonid species (Fig. 44).

Materials. 6 specimens, 97.4-140.0 mm SL. CAS 15149 and HUMZ 51923, 47°49.7'N, 124°49.3'W, depth 50 m, off Oregon, 19 August 1972; LACM 31982-5, 38°26'N, 123°8.5'W, 10 fms, 1/2 mile SSW of Mile Rocks, Sonoma County, California, by otter trawl, 10 August 1971.

Genus *Ocella* Jordan et Hubbs, 1925

Ocella Jordan and Hubbs, 1925, pp. 290-291 (type species, *Agonus dodecaedron* Tilesius).

Iburina Jordan and Hubbs, 1925, pp. 290-291 (type species, *Occa iburia* Jordan et Starks).

Iburiella Jordan and Hubbs, 1925, pp. 290-291 (type species, *Iburiella kasawae* Jordan et Hubbs).

External diagnosis. *Ocella* is distinguished from other genera of the family Agonidae in having the following characters: two dorsal fins; 8-15 dorsal fin spines; 6-10 dorsal fin rays; 13-20 anal fin rays; 14-19 pectoral fin rays; no snout

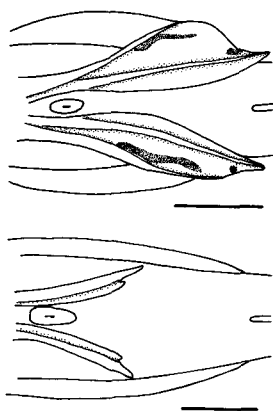

Fig. 44. Pelvic fin of *Chesnonia verrucosa*. top, male, 103.2 mm SL, LACM 31982-5; bottom, female, 114.0 mm SL, LACM 31982-5. Scale bars indicate 10 mm.

barbel; nasal tube never reaching upper jaw; nasal bones never attached to each other; no rostral plate; nasal bone never beyond upper jaw; neither ethmoidal nor parietal spines; lower jaw projecting forward beyond upper jaw; maxillary with a short barbel or flap; no barbel on lower jaw tip; teeth on palatine and prevomer; six branchiostegal rays; no occipital pit; interorbital width 2.6-5.9 in HL; absence or very short distance of interdorsals; 37-44 vertebrae; 5-10 predorsal plates; 39-47 lateral line plates; breast covered with enlarged plates and prickles.

Internal diagnosis. *Ocella* differs from other genera of Agonidae in possessing the following osteological characters: large articular facet of lachrymal; fifth infraorbital bone attaching to second one; no attachment between entopterygoid and metapterygoid; no ectopterygoid; no basihyal; attachment between prevomer and ethmoid; anterior articular facet of prefrontal; no pore between actinosts on pectoral girdle; inner pelvic keel; no pleural rib; posterior insertion of dorsal and anal pterygiophores; one spiny ray on first dorsal pterygiophore; one epural.

Remarks. The genus *Ocella* is represented by four species, *O. dodecaedron*, *O. iburia*, *O. kuronumai* and *O. kasawai*, and one doubtful species, *O. impi*. *O. impi* is confined to the west coast of North America, and *O. iburia*, *O. kuronumai* and *O. kasawai* are distributed in the waters of northern Japan. *O. dodecaedron* is widely distributed in the northern North Pacific, Japan, Okhotsk and Bering seas.

O. impi, as discussed below, is a doubtful species. Accordingly, the generic diagnosis is based on the first four species listed above.

Key to the species of *Ocella*

- 1a. Dorsolateral plates 30 or more. Supralateral plates 33 or more. Ventrolateral plates 25 or more. 2.
- 1b. Dorsolateral plates 24. Supralateral plates 30. Ventrolateral plates 20. *O. impi*
- 2a. Subpectoral region between infralateral plate and ventrolateral plate naked. First dorsal spines 11 or less (mostly 10 or less). Lateral line plates 42 or less (mostly 41 or less). *O. dodecaedron*
- 2b. Subpectoral region between infralateral plate and ventrolateral plate entirely covered with prickles and plates. First dorsal spines 11 or more. Lateral line plates 42 or more (mostly 43 or more). 3.
- 3a. A second infraorbital spine present. Pectoral fin with dark spots. . . . 4.
- 3b. No second infraorbital spine. Pectoral fin with 3 bands. *O. kasawai*
- 4a. Enlarged plates on dorsal surface of head and cheek region. Subpectoral region with 7 or more plates. *O. kuronumai*
- 4b. No enlarged plate on dorsal surface of head. Cheek region without enlarged plate or rarely with five or less enlarged plates. Subpectoral region with 6 or less plates along infralateral plates. *O. iburia*

Ocella dodecaedron (Tilesius, 1813)

(Japanese name: Kamuto-sachiuo)

Fig. 45.

Agonus dodecaedron Tilesius, 1813, pp. 439-447, pl. 13 (original description; type locality, Kamchatka).

Phalangistes loricatus Tilesius, 1814, pp. 114-115, pl. 19 (type locality, Kamchatka).

Aspidophorus dodecaedrus. Cuvier, 1829, p. 209. (description).

Brachyopsis dodecaedrus. Bean, 1882, p. 263 (Kamchatka).

Occa dodecaedron. Jordan and Evermann, 1898, pp. 2044-2046, pl. 308, fig. 743 (key and description; locality, Bristol Bay).

Occa dodecaedra. Wilimovsky, 1954, p. 286 (listed).

Occella dodecaedron. Jordan and Hubbs, 1925, pp. 290-291 (key).

Chesnonia dodecaedron. Iredale and Whitley, 1969, p. 45 (mentioned in text).

Diagnosis. In addition to the characters in the key, *O. dodecaedron* is distinguished from other species of *Occella* in having following characters: no nasal spine; no second infraorbital spine; cheek region with five or less tiny plates and lacking prickles; uppermost preopercular spine without a supplementary spine; neither plate nor prickle on subpectoral region; a short flap on maxillary.

Counts. D. VIII-XI-6-9; A. 13-16; P1. 14-16; P2. I, 2; C. 6+5; Br. 6; V. 37-40; LLP. 39-42; Gr. 1-2+10-12; PP. 8-10; MDR. 4-9; DLR. 30-35; SLR. 33-37; ILR. 36-39; VLR. 30-37; MVR. 1-6.

Proportional measurements. Head 4.2-4.8 in SL; predorsal 2.6-3.0; pectoral fin 3.9-4.8; pelvic fin 7.1-11.5; caudal fin 5.6-7.4. Snout 3.9-5.5 in HL; orbit diameter 4.0-5.3; interorbital width 4.8-5.9; longest dorsal fin 2.0-2.7; longest anal fin 2.7-3.7. Body width 0.5-0.8 in its depth. Width of caudal peduncle 1.0-1.4 in its depth. Pelvic-anus length 3.8-6.4 in pelvic-anal length.

Body depressed, highest at just behind head. Head moderate in size, highly depressed. Nasal bones without spine, never attached to each other. Nasal tube short, never reaching upper jaw. Snout depressed, paddle like shaped, without ethmoidal spine. Postocular with a blunt knob. A very low knob on parietal. Frontal-parietal ridges low, converged each other posteriorly. Posttemporal ridge indistinct with very low knobs. Eye small, without bony tubercles on eye ball. No spine on second infraorbital. Free lachrymal margin with four spines. Interorbital region concave. Lower jaw projecting forward beyond upper jaw. Maxillary with a short flap, reaching anterior margin of pupil. Preopercular spines three or four, uppermost one large without supplementary spine, other two or three blunt and small. Teeth on jaws, prevomer and palatine. Gill membranes united, free from isthmus.

Dorsal fins two, connected each other or separated in short distance. Anal fin originating below sixth dorsal spine. Pectoral fin sublateral, never reaching anal

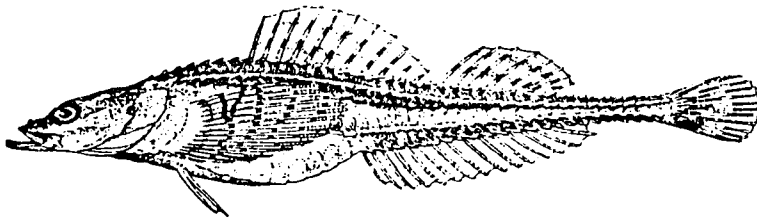

Fig. 45. *Occella dodecaedron* (Tilesius). Taken from Jordan and Evermann, 1900.

origin. Pelvic fin short. Caudal fin round.

Body plates of dorsolateral, supralateral, infralateral rows, with a spine. Plates of ventrolateral row with a blunt spine. Plates of middorsal and midventral rows smooth, without spine. Enlarged bony plates on middle part of breast and along margin of gill membranes. Region between pelvic base and lower pectoral base coarsely covered with small plates. Back of head, anterior dorsal of body, gular region, united gill membrane, proximal of first and second branchiostegal rays, area around anus covered with prickles or tiny plates. Cheek region naked or with five or less prickles. Subpectoral region almost naked with one or two small plates.

Color. In preserved specimens, body brown, darker dorsally, paler ventrally. A dark stripe on lateral line. Head darker dorsally, paler ventrally. A dark stripe from lachrymal, through beneath ventral margin of orbit, to lower part of opercle. Cheek region scarcely pigmented. Jaw pale, dark anteriorly. Dorsal fins pale. First dorsal fin with two bands, one marginally, one centrally. Second dorsal fin with two bands and a blotch: one band marginally, another one from first ray of center to base of fifth ray; a blotch between base of first and third rays. Anal fin pale, with dark base. Posterior part of anal fin dark. Pectoral fin pale, with five rows of spots on rays. Pelvic fin pale. In male, a black stripe on membrane of pelvic fin, no on female. Caudal fin dark. Mouth, gill cavities and peritoneum pale.

Sexual dimorphism. In male, a black stripe on pelvic fin membrane between rays, no stripe in female. Pelvic fin ray longer in male (7.1–8.6 in SL) than those in female (9.0–11.5).

Distribution. Peter the Great Bay; northern Japan Sea; Musashi Bank, Oshoro Bay, Kushiro, Muroran in Japan; Aniwa Bay; Okhotsk Sea; Kuril Islands; Bering Sea; Alaska Bay to California.

Remarks. A sexually dimorphic color pattern in *Ocella dodecaedron* was described by Gilbert (1896). However, because living or fresh specimens were not available during this study, Gilbert's descriptions could not be satisfactorily confirmed.

Materials. 27 specimens, 80.4–163.2 mm SL. HUMZ 5518, off Oshoro, Hokkaido; HUMZ 5609, 5611, off Oodomari, Sakhalin; HUMZ 13097, 58°49'N, 168°28'W, April 1954; HUMZ 69030, 58°23'N, 160°00'W, 19 m, Bering Sea, by otter trawl, 8 May 1973; HUMZ 69033, 58°15'N, 162°30'W, 35 m, Bering Sea, 11 May 1973; HUMZ 76333, 58°05'N, 165°42.5'W, 49 m, Bering Sea, 28 May 1978; HUMZ 76477, 57°04.5'N, 161°49.2'W, 50–52 m, Bering Sea, 23 May 1978; HUMZ 76537–76541, 57°34.3'N, 161°49.2'W, 52 m, Bering Sea, 25 May 1978; HUMZ 76624–76626, 58°13.4'N, 163°23.4'W, 41 m, Bering Sea, 27 May 1978; HUMZ 76798, 57°17.5'N, 160°18'W, 52 m, Bering Sea, 23 May 1978; HUMZ 76857, 57°19.6'N, 163°21.3'W, 52 m, Bering Sea, 22 May 1978; HUMZ 76885–76887, 57°05.3'N, 162°46.6'W, 59 m, Bering Sea, 23 May 1978; HUMZ 76956, 57°50.5'N, 163°15.0'W, 46 m, Bering Sea, 26 May 1978; HUMZ 76993–76995, 57°34.7'N, 163°42.8'W, 50 m, Bering Sea, 26 May 1978; HUMZ 77385, 57°50.5'N, 163°15.0'W, 46 m, Bering Sea, 26 May 1978; HUMZ 93422, off Nemuro, Hokkaido, 10 m, by trawl, 31 July 1981.

Ocella iburia (Jordan et Starks, 1904)

(Japanese name : Saburou)

Fig. 46.

Occa iburia Jordan and Starks, 1904, pp. 585-586, fig. 6 (original description; type locality, Tomakomai, Hokkaido).

Iburina iburia. Jordan and Hubbs, 1925, pp. 290-291 (key).

Chesnonia iburia. Iredale and Whitley, 1969, p. 45 (mentioned in text).

Ocella iburia. Gruchy, 1970, pp. 1110-1114 (comparison with *O. impi*, in key).

Diagnosis. In addition to the characters in the key, *O. iburia* is distinguished from other species of *Ocella* in having following characters: a nasal spine; cheek region with prickles; uppermost preopercular spine without a supplementary spine; a short flap or barbel on maxillary; prickles on branchiostegal rays.

Counts. D. XII-XIV-8-10; A. 16-18; P1. 16-19; P2. I, 2; C. 6+5; Br. 6; V. 41-44; LLP. 43-47; Gr. 1-2+0-1+10-11; PP. 6-8; MDR. 4-9; DLR. 34-39; SLR. 35-40; ILR. 39-43; VLR. 34-41; MVR. 2-6.

Proportional measurements. Head 4.2-4.8 in SL; predorsal 3.1-3.6; pectoral fin 4.0-4.9; pelvic fin 7.5-10.6; caudal fin 5.7-6.9. Snout 4.1-5.4 in HL; orbit diameter 4.3-5.0; interorbital width 4.0-4.8; longest dorsal fin 2.1-3.3; anal fin 2.6-3.6. Body width 0.7-0.8 in its depth. Width of caudal peduncle 0.8-1.1 in its depth. Pelvic-anus length 3.3-5.0 in pelvic-anal length.

Body depressed. Head moderate in size, depressed. A nasal spine directed posterodorsally. Nasal tube short. Snout pointed. Postocular with a blunt spine. A low knob on parietal. Posttemporal ridge with two knobs, ending as a posttemporal spine. Nasal bones never attached to each other. No rostral plate. Eye moderate in size, without bony tubercles. A second infraorbital bone with a spine. Lachrymal with a knob just in front of anterior margin of orbit. Free lachrymal margin with four spines, anterior one directed forward, other three posteroventrally. Interorbital wide, slightly concave. Upper jaw included in lower one. Maxillary

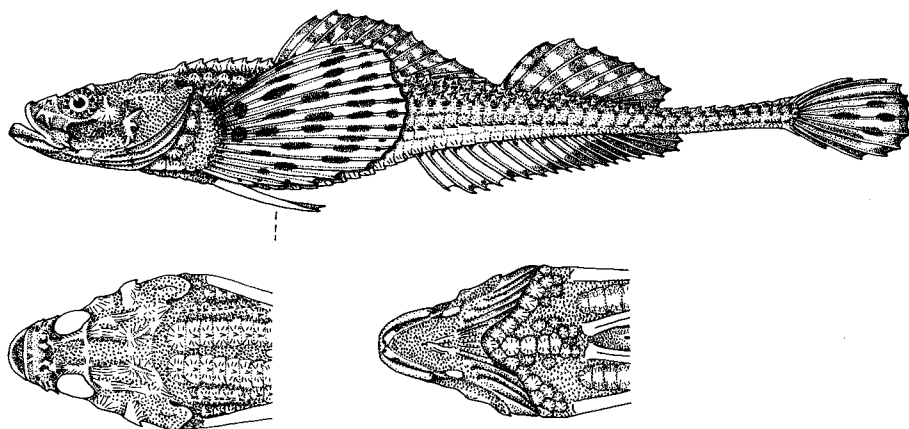

Fig. 46. *Ocella iburia* (Jordan et Starks): HUMZ 96678, 183.0 mm SL.

with a short flap, reaching anterior margin of pupil. Preopercular spines four, uppermost large directed posteriorly. Villiform teeth in bands on jaws, prevomer and palatine. Gill membranes joined, free from isthmus.

Dorsal fins two, connected each other or separated in short distance. Anal fin originating below 10th dorsal spine. Length of anal rays shorter than those of dorsal fins. Pectoral fin round. Pelvic fin short. Caudal fin round.

Body plates of dorsolateral, middorsal, supralateral, infralateral and ventrolateral rows, with a spine. Midventral plates smooth. Lateral line plates with a spine, but no spine on caudal peduncle. Head, breast, axil, around anus, gular region, lower jaw, cheek, united gill membranes, and branchiostegal rays, with prickles. No enlarged bony plate on dorsal surface of head and infraorbital region. Subpectoral region with six or less plates. Breast plates on midventral and along margin of gill membranes.

Color. In preserved specimens, body brown, darker dorsally, paler ventrally. Six indistinct dark bands on back, one on caudal peduncle, two on second dorsal fin, and three on first dorsal fin. Anal fin pale, its posterior part dark. Pelvic fin pale. Pectoral fin pale, with blotches. Caudal fin dark, with darker spots. Head darker dorsally, paler ventrally. Lower jaw dark. Mouth and gill cavities, and peritoneum pale.

Sexual dimorphism. Pelvic fin longer in male (7.5-9.4 in SL) than those in female (8.6-10.6).

Distribution. Pacific coast of northern Japan, south to Cape Inubo, Chiba Prefecture; Monbetsu, Okhotsk coast of Hokkaido.

Remarks. *Ocella iburia* is closely similar to *O. kuronumai*, which is found in the Japan Sea. Ueno (1967) recorded *O. iburia* from northern Honshu, south to Niigata and Choshi, and from the Pacific and Okhotsk coasts of Hokkaido. The present study suggested that *O. iburia* is, in fact, found only on the Pacific coast of Northern Japan, and *O. kuronumai* is confined to the Japan Sea coast of Honshu.

Materials. 30 specimens, 79.3-215.0 mm SL. FRKU 4013 and 4021, off Choshi, Chiba Pref., March 1937; FRKU 5497, off Choshi, Chiba Pref., 20-26 November 1937; HUMZ 5566, off Oozuchi, Iwate Pref.; HUMZ 15520, Funka Bay, by otter trawl; HUMZ 59621 and 59622, off Sanriku, Miyako fish market, 13 October 1976; HUMZ 71296, 71306, 71308, 71316, 71291, 71293, 71294, 71297, 71303, 71311, 71314, off Onahama, Fukushima Pref., depth 50-80 m, 10 November 1977; HUMZ 71456, 71458, 71462, 71463, 71527, off Onahama, Fukushima Pref., 50-80 m, by otter trawl, 14 November 1977; HUMZ 71220, off Onahama, Fukushima Pref., 200-300 m, by trawl, 8 November 1977; HUMZ 77558, off Tomari, Aomori Pref., by set net, 28 September 1978; HUMZ 89736, off Mukawa, Hokkaido, 8 October 1980; HUMZ 80925, off Tomakomai, Hokkaido, by gill net, 23 October 1978; HUMZ 89823, off Tomakomai, Hokkaido, by gill net, 2 October 1974; HUMZ 96678 and a uncatalogued specimen, Kuji fish market, Iwate Pref., April 1981.

Ocella kuronumai (Freeman, 1951)

(Japanese name: Shirou)

Fig. 47.

Occa (Iburina) kuronumai Freeman, 1951b, pp. 24-25, fig. 2 (original description; type locality, off Niigata, Japan Sea).

Occa iburia. Katayama, 1940, p. 19 (listed; locality, Toyama Bay).

Occa kuronumai. Matsubara, 1955, p. 1166 (key).

Occella kuronumai. Gruchy, 1970, pp. 1110-1114 (comparison with *O. impi*, in key).

Diagnosis. In addition to the characters in the key, *O. kuronumai* is distinguished from other species of *Occella* in having following characters: a nasal spine; head, cheek and subpectoral regions covered with enlarged plates; uppermost preopercular spine without a supplementary spine; a short flap or barbel on maxillary; branchiostegal rays covered with prickles.

Counts. D. XI-XIII-9-10; A. 17-20; P1. 15-17; P2. I, 2; C. 6+5; Br. 6; V. 40-43; LLP. 42-45; Gr. 2+0-1+10-11; PP. 7-8; MDR. 4-8; DLR. 33-38; SLR. 34-38; ILR. 39-42; VLR. 33-39; MVR. 3-6.

Proportional measurements. Head 4.2-4.7 in SL; predorsal 2.9-3.1; pectoral fin 4.0-4.8; pelvic fin 8.3-11.7; caudal fin 5.6-6.7. Snout 4.2-5.1 in HL; orbit diameter 4.1-4.8; interorbital width 4.2-4.9; longest dorsal fin 2.4-3.0; longest anal fin 2.9-3.3. Body width 0.6-0.7 in its depth. Width of caudal peduncle 0.9-1.0 in its depth. Pelvic-anus length 4.1-6.0 in pelvic-anal length.

Body depressed, elongate. Head moderate in size, depressed. A nasal spine directed posterodorsally. Nasal tube short. Snout paddle like shaped, without ethmoidal spine. Postocular with a blunt spine. A low knob on parietal. Posttemporal ridge with two knobs, ending as a posttemporal spine. Nasal bones never attached to each other. Eye moderate in size, without bony tubercle. A second infraorbital bone with a spine. Lachrymal with a knob just in front of anterior margin of orbit. Free lachrymal margin with four spines, anterior one directed forward, other three posteroventrally. Interorbital wide, smooth, slightly concave. Upper jaw included in lower one. Maxillary with a short flap (3.7-8.1 in orbit), reaching anterior margin of pupil. Preopercular spines four, uppermost one large directed posteriorly. Villiform teeth in bands on jaws, prevomer and palatine. Gill membranes joined, free from isthmus.

Dorsal fins two, connected each other or separated in short distance. Anal fin originating below dorsal spine. Length of anal rays shorter than those of dorsal fins. Pectoral and caudal fins round. Pelvic fin short.

Body plates of dorsolateral, middorsal, supralateral, infralateral, and ventrolateral rows, with a spine. Midventral plates smooth. Lateral line plates with a spine, but no spine on caudal peduncle. Head, breast, axil, around anus, gular region, lower jaw, cheek, united gill membranes, and branchiostegal rays, with prickles. Enlarged bony plates on dorsal surface of head and infraorbital region.

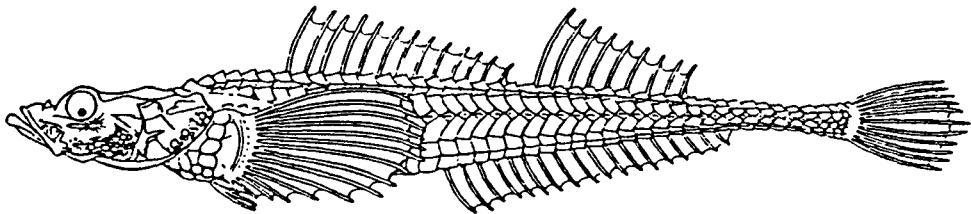

Fig. 47. *Occella kuronumai* (Freeman). Taken from Freeman, 1951b.

Subpectoral region with seven or more plates. Breast plates on midventral and along margin of gill membrane.

Color. In preserved specimens, body brown, darker dorsally, paler ventrally. Dark bands on back, one on caudal peduncle, two on second dorsal fin, and three on first dorsal fin. Anal fin pale, with dark posterior part. Pelvic fin pale. Pectoral fin pale, with dark spots. Caudal fin dark, with darker spots. Lower jaw dark. Mouth and gill cavities, and peritoneum pale.

Sexual dimorphism. Pelvic fin longer in male (8.3-9.7 in SL) than those in female (9.8-11.7).

Distribution. Japan Sea coast of Honshu, south to Toyama Bay.

Remarks. *Ocella kuronumai* is similar to *O. iburia*, but differs in having enlarged plates on the head, cheek and subpectoral regions.

The species is taken by otter trawl, set net and gill net from sandy and muddy bottoms. In aquaria, it can be seen during the day, creeping along the bottom in the daytime (Mr. Kano, Uozu Aquarium, pers. comm.).

Materials. 26 specimens, 43.6-193.5 mm SL. HUMZ 51929, off Niigata, 26 July 1967; HUMZ 51931-51933, off Niigata, 5 September 1966; HUMZ 51934-51935, Toyama Bay; HUMZ 51998, Mano Bay, Sado I., by gill net, 25 March 1976; HUMZ 62376, Mano Bay, Sado I., depth 30-50 m, by trawl, 23 May 1971; HUMZ 62380, Mano Bay, Sado I., 6.5-6.9 m, by beam trawl, 24 May 1972; HUMZ 64788-64802, off Kamo, Yamagata Pref., 300 m, by trawl, 5 December 1977; HUMZ 78495-78496, off Mano Bay, Sado I., 87-160 m, 24 November 1978.

***Ocella kasawai* (Jordan et Hubbs, 1925)**

(Japanese name: Yase-saburou)

Fig. 48.

Iburiella kasawae Jordan and Hubbs, 1925, pp. 290-293, pl. 11, fig. 1 (original description; type locality, Tomakomai and Kushiro, Japan).

Occa kasawae. Taranetz, 1937, p. 123 (key).

Occa kasawai. Matsubara, 1955, p. 1166 (key).

Iburia kasawae. Tanaka, 1931, p. 46 (listed).

Ocella kasawai. Gruchy, 1970, pp. 1110-1114 (comparison with *Ocella impi*).

Diagnosis. In addition to the characters in the key, *O. kasawai* is distinguished from other species of *Ocella* in having following characters: a nasal spine; enlarged bony plates and prickles on cheek region; uppermost preopercular spine without supplementary spine; a short flap on maxillary.

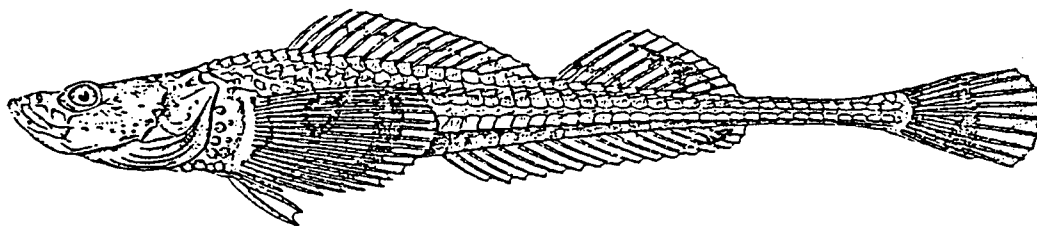

Fig. 48. *Ocella kasawai* (Jordan et Hubbs). Taken from Lindberg and Krasnyukova, 1987.

Counts. D. XIII-XV-8-9; A. 15-17; P1. 17-19; P2. 1, 2; C. 6+5; Br. 6; V. 42-44; LLP. 43-46; Gr. 1-2+8-11; PP. 5-6; MDR. 2-7; DLR. 36-41; SLR. 38-42; ILR. 37-43; VLR. 34-39; MVR. 2-5.

Proportional measurements. Head 3.9-4.7 in SL; predorsal 3.2-3.6; pectoral fin 4.1-4.7; pelvic fin 7.3-9.9; caudal fin 5.5-7.0. Snout 4.1-4.9 in HL; orbit diameter 4.1-5.7; interorbital width 2.6-4.3; longest dorsal fin 1.5-3.2; longest anal fin 2.5-3.3. Body width 0.7-0.8 in its depth. Width of caudal peduncle 0.8-1.1 in its depth. Pelvic-anus length 3.5-5.8 in pelvic-anal length.

Head and body depressed. Nasal spine small, directed posterodorsally. Nasal bones never attached to each other. Nasal tube short. Snout pointed. Postocular with a blunt knob. A low knob on parietal. Posttemporal ridge with two knobs, one on tabular and one on posttemporal. Eye small, without bony tubercles. No spine on second infraorbital bone. Free lachrymal margin with four spines, one blunt and directed forward, others sharp and projecting ventrally. Interorbital region wide, slightly concave. Frontal-parietal ridges converging posteriorly. Upper jaw included in lower jaw. Maxillary with a short flap, reaching anterior margin of pupil. Preopercular spines four, uppermost large, directed posteriorly, others small and blunt. Villiform teeth on jaws, prevomer and palatine. Gill membranes united, free from isthmus.

Dorsal fins two, connected to each other or separated for short distance. Anal fin rays shorter than those of dorsal fins. Pectoral fin sublateral, round, never reaching anal origin. Pelvic fin short. Caudal fin round.

Body plates of dorsolateral, supralateral, infralateral, and ventrolateral rows, with a spine. Middorsal plates with a blunt spine. Plates of midventral row and breast smooth. Region between pelvic and pectoral fin bases covered with prickles and tiny plates. Anterior lateral line plates with a spine. Head, subpectoral, cheek, upper and lower jaws, united gill membranes, branchiostegal rays, and around anus, covered with prickles and tiny plates.

Color. When fresh, body orange, bluish black dorsally. Six bluish black bands on body. Head orange, dark brown dorsally. Dorsal fins bluish black, with orange blotches. Second dorsal fin with a row of blotches distally and an orange band basally. Anal, pectoral and pelvic fins orange. Pectoral fin with three bluish black bands. Anal fin with a bluish black blotch posteriorly. Caudal fin bluish black, with four irregular orange blotches.

In preserved specimens, head and body brown, darker dorsally, paler ventrally. Seven dark bands on body, three on first dorsal fin base, two on second dorsal fin base, and two on caudal peduncle. Dorsal fins pale. First dorsal fin with irregular dark bands. Second dorsal fin with two bands, one basally, and one distally. Anal fin pale, dark posteriorly. Pectoral fin pale, with three bands, one distal, one intermediate, and one basal. Pelvic fin pale. Caudal fin dark, with pale blotches. Mouth and gill cavities, peritoneum pale.

Sexual dimorphism. Pelvic fin longer in male (7.3-8.2 in SL) than those in female (9.0-9.9).

Distribution. Pacific coast of Hokkaido, from Muroran to Kiritappu.

Materials. 23 specimens, 57.4-285.0 mm SL. HUMZ 34019, off Kushiro, depth 140-170 m, 6 September 1974; HUMZ 45394 and 47519, 42°32'N, 143°48'E, 87 m, by otter trawl, 6

September 1975; HUMZ 58619-58626 and 58628-58633, off Otanoshike, near Kushiro, 20 m, by beam trawl of Kaikou Maru, 28 August 1976; HUMZ 78551, off Kiritappu, Hokkaido, by beach sein, 18 September 1971; HUMZ 80730, Akkeshi Bay, by set net, 6 July 1978; HUMZ 87887, Akkeshi Bay, 1979; HUMZ 88098, off Monsei, near Akkeshi, by set net, 5 October 1978; HUMZ 89821 and 89826, off Tomakomai, Hokkaido, by beam trawl, 2 October 1974.

***Ocella impi* Gruchy, 1970**

Fig. 49.

Ocella impi Gruchy, 1970, pp. 1109-1114, fig. 1 (original description; type locality, mouth of Sokonun River, McIntyre Bay, Graham I., British Columbia).

Specimens were not available for examination. The following description is taken from Gruchy (1970).

Diagnosis. In addition to the characters in the key, *O. impi* is distinguished from other species of *Ocella* in having following characters: nasal spine present; no second infraorbital spine; no bony plate on cheek; naked subpectoral region; a short flap-like barbel on maxillary.

Counts. D. IX-6; A. 9; PI. 18; P2. 2; LLP. 35; PP. 6; MDR. 10; DLR. 24; SLR. 30; ILR. 35; VLR. 20; MVR. 10.

Proportional measurements. Head 3.5 in SL; body depth 5.0; length of Caudal peduncle 3.5; depth of caudal peduncle 14.0. Snout 3.0 in HL; orbit diameter 5.0.

Distribution. Mouth of Sokonun River, McIntyre Bay, Graham Island, British Columbia (54°02'N, 132°00'W).

Remarks. *Ocella impi* was described by Gruchy (1970), based on a single juvenile or prejuvenile specimen (17.4 mm SL). It is most similar to *Stellerina xyosterna*, but is distinguished from the latter in having prevomerine and palatine teeth and a large number of infralateral plates. However, it remains uncertain whether or not *O. impi* is a distinct species, or merely a synonym of *S. xyosterna*. Because the specimen described was at an immature stage, the above two distinguishing characters may transform in the course of development. Infralateral plates are continuous in *Ocella* species, extending from the upper corner of the pectoral fin base to the caudal fin base, but in *S. xyosterna* the plates originate a short distance behind the pectoral fin base. Four or five small plates occur between the upper corner of the pectoral fin base and the origin of the infralateral plates. This indicates that the infralateral plates of *S. xyosterna* may be continuous, as in *Ocella*,

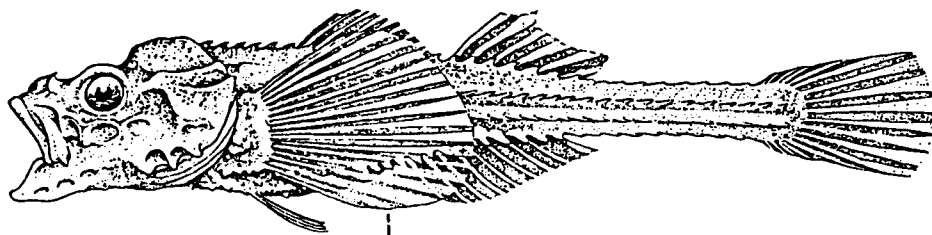

Fig. 49. *Ocella impi* Gruchy. Taken from Hart, 1973.

in early developmental stages and are gradually reduced in size to tiny plates. Such reduction can be seen in the ventrolateral plates of *Hypsagonus proboscidalis*, which are present as a distinct row in early stage, but absent in the adult. Thus, it is necessary to examine specimens of larval and juvenile *S. xyosterna*. Although *O. impi* remains a likely synonym of *S. xyosterna*, it is here treated as a doubtfully valid species.

Genus *Tilesina* Schmidt, 1904

Tilesina Schmidt, 1904, p. 134 (type species, *Tilesina gibbosa* Schmidt).

External diagnosis. *Tilesina* is distinguished from other genera of the family Agonidae in having the following characters: two dorsal fins; 17-21 dorsal fin spines; 6-9 dorsal fin rays; 23-27 anal fin rays; 13-16 pectoral fin rays; no snout barbel; short nasal tube never reaching upper jaw; nasal bones never attached to each other; no rostral plates; nasal bone never beyond upper jaw; no ethmoidal spine; parietal with two knobs or low blunt spines; upper jaw included in lower one; a short barbel on posterior corner of maxillary; no barbel on lower jaw tip; teeth on prevomer and palatine; six branchiostegal rays; no occipital pit; interdorsal distance 3.0-11.5 in HL; 52-54 vertebrae; 5-8 predorsal plates; 53-56 lateral line plates; posterior margin of supraocular crest greatly serrated and may bear several small spines.

Internal diagnosis. *Tilesina* differs from other genera of Agonidae in possessing the following osteological characters: large articular facet on lachrymal; fifth infraorbital bone attaching to second; no attachment between entopterygoid and metapterygoid; small ectopterygoid; attachment between prevomer and ethmoid; anterior articular facet on prefrontal; no pores between actinosts on pectoral girdle; inner pelvic keel; no pleural ribs; posterior insertion of dorsal and anal pterygiophores; one spiny ray on first dorsal pterygiophore; one epural.

Remarks. *Tilesina* is represented by a single species, *T. gibbosa*, which is confined to the Japan Sea and adjacent waters.

Tilesina gibbosa Schmidt, 1904

(Japanese name: Oni-shachiuo)

Fig. 50.

Tilesina gibbosa Schmidt, 1904, p. 134, pl. 4, fig. 1a-c and 8 (original description; type locality, Japan and Okhotsk Seas).

Tilesina hubbsi Freeman, 1951b, pp. 21-24, fig. 1 (Siberia, Japan Sea).

Diagnosis. See account of the genus *Tilesina*.

Counts. D. XVII-XXI-6-9; A. 23-27; PI. 13-16; P2. I, 2; C. 6+5; Br. 6; V. 52-54; LLP. 53-56; Gr. 1-2+0-1+12-18; PP. 5-8; MDR. 7-12; DLR. 39-45; SLR. 46-49; ILR. 48-51; VLR. 39-45; MVR. 3-8.

Proportional measurements. Head 4.6-5.0 in SL; predorsal 3.3-3.7; pectoral fin 4.3-5.3; pelvic fin 8.0-11.9; caudal fin 6.1-7.7. Snout 3.2-4.0 in HL; orbit diameter 4.2-5.5; interorbital width 8.7-11.0; dorsal fin 1.7-2.2; anal fin 2.7-4.0. Body width 0.8-1.0 in its depth. Width of caudal peduncle 0.8-1.1 in its depth. Pelvic-anus length 2.9-5.6 in pelvic-anal length.

Body elongate, depressed, highest at predorsal region and tapering to caudal

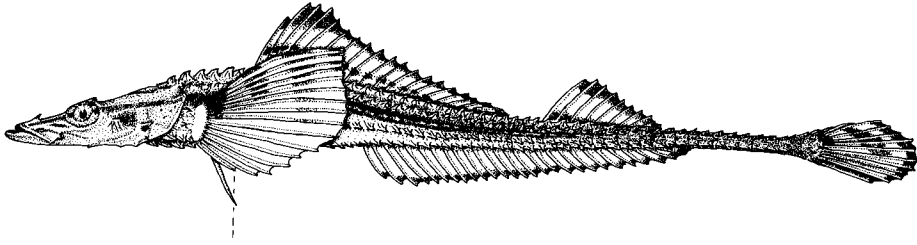

Fig. 50. *Tilesina gibbosa* Schmidt: HUMZ 92198, 194.6 mm SL.

peduncle. Head depressed. Nasal bones with a small spine directed posteriorly, never attached to each other. Nasal tube very short. Snout paddle-like. Supraocular crest ending as serrated margin or spines. Two knobs or blunt spines on parietal. Posttemporal ridge with three or four blunt spines, ending as a posttemporal spine. No ethmoidal spine. Mouth small, lower jaw projecting forward beyond upper one. Maxillary never reaching anterior margin of eyeball, with a short barbel 4.3-18.1 in orbit diameter. Eye moderate in size, without bony tubercles. Interorbital narrow, deeply concave. A large spine or rarely three spines on second infraorbital, sometimes with a supplementary spine. First infraorbital with a spine on infraorbital ridge and on free margin. Free lachrymal margin with three spines. Preopercular spines three, upper two large and sharp. A spine on opercle. Gill membranes united, free from isthmus. Teeth on jaws, prevomer and palatine.

Dorsal fins two. Interdorsal distance 3.0-11.5 in HL. Anal fin originating below center of first dorsal fin base. Pectoral fin sublateral, reaching anal origin. Pelvic fin short. Caudal fin round.

Plates of dorsolateral, middorsal, supralateral, infralateral, ventrolateral and midventral rows, and breast region with a sharp spine. Plates of lateral line row with a spine anteriorly, lacking a spine posteriorly. Predorsal region and dorsal surface of head with prickles. Pelvic-anal region with tiny plates. Cheek, subpectoral, gular and gill membranes without plates or prickles.

Color. In preserved specimens, body brown, darker dorsally, paler ventrally. Dark spots on dorsal surface of body. A dark stripe along anterior lateral line. A dark stripe from snout tip, through beneath posttemporal ridge, to upper corner of opercle. Dorsal and anal fins pale, with a dark band distally. Second dorsal fin with dark blotches basally. First dorsal fin with a dark broken line centrally or lacking. Pectoral fin pale, upper four or five rays dark with darker spots. Pelvic fin pale. Caudal fin dark, with darker margin. Mouth and gill cavities, and peritoneum pale.

Sexual dimorphism. Pelvic fin longer in male (8.0-11.1 in SL) than those in female (10.3-11.9).

Distribution. Japan Sea south to Pusan and Kasumi; Pacific coast of Japan south to Shiogama, Miyagi Prefecture; Okhotsk coast of Hokkaido; Sakhalin.

Remarks. *Tilesina hubbsi* was described by Freeman (1951b), based on only a single specimen from off Siberia, Japan Sea. He considered that *T. hubbsi* was

distinguished from *T. gibbosa*, by the presence of two spines on the suborbital stay, a sharp spine on the ventral rim of the orbit, a spine on the preorbital, five sharp spines or crests on the temporal ridge, more prominent occipital crests, greatly serrated supraocular crests, bearing several spines on the posterior margin, and a more prominent elevated dorsal spine on the preopercle, with a short, blunt spine at its anterior base. However, the examined specimens largely from around Hokkaido vary in head spine condition between *T. hubbsi* and *T. gibbosa*, and younger specimens are more spinous than older ones. Because there are no clear distinctions between the two species, it is considered that *T. hubbsi* is a junior synonym of *T. gibbosa*.

Materials. 29 specimens, 137.4–323.7 mm SL, by otter trawl. HUMZ 13004, off Mashike (Mashike fish market) Japan Sea coast of Hokkaido, 30 October 1954; HUMZ 15453, Funka Bay, Hokkaido; HUMZ 33298, 42°26'N, 140°34' E, Funka Bay; 18 May 1965; HUMZ 34179, off Kushiro, Hokkaido, depth 140–170 m, 6 September 1974; HUMZ 45660, 42°51'N, 144°35.9' E, 82 m, off Konbumori, near Kushiro, 16 July 1975; HUMZ 45834 and 45842, off Kushiro, 1975; HUMZ 45890, 45907 and 45911, 42°54'N, 144°36' E, 40 m, off Konbumori, 16 July 1975; HUMZ 45940, 42°48'N, 144°38' E, 100 m, off Konbumori, 16 July 1975; HUMZ 47458, 47459, 47461, 47468, 47470, 47471, 47473, 47474, 47476, 42°32'N, 143°48' E, 87 m, 6 September 1975; HUMZ 64783, off Kamo, Yamagata Pref., 300 m, 5 December 1977; HUMZ 67458 and 67459, 43°11'N, 145°48' E, 73 m, off Nemuro Peninsula, 3 July 1977; HUMZ 68389, 43°48'N, 141°11' E, 185–194 m, off Ofuyu, 15 May 1977; HUMZ 87189, off Usujiri, Funka Bay, 6 May 1980; HUMZ 87428 and 87429, off Muroan, Pacific coast of Hokkaido, 160 m, 15 May 1980; HUMZ 92198, 43°58'N, 144°28' E, 40 m, off Hamako-simizu, by beam trawl, 1 June 1979; HUMZ 92219, off Hiroo, Pacific coast of Hokkaido, September 1975.

Genus *Brachyopsis* Gill, 1862

Brachyopsis Gill, 1862b, p. 77 (type species, *Agonus rostratus* Tilesius).

Siphagonus Steindachner, 1877, p. 188 (type species, *Agonus segaliensis*).

External diagnosis. *Brachyopsis* is distinguished from other genera of the family Agonidae in having the following characters: two dorsal fins; 7–9 dorsal fin spines; 7–9 dorsal fin rays; 12–15 anal fin rays; 14–15 pectoral fin rays; no snout barbel; short nasal tube never reaching upper jaw; nasal bones never attached to each other; no nasal spine; no rostral plates; nasal bone never beyond upper jaw; no ethmoidal spine; parietal with one or two low knobs; upper jaw included in lower one; maxillary without a barbel or flap; no barbel on lower jaw tip; no palatine teeth; six branchiostegal rays; no occipital pit; interdorsal connected by low membrane; 42–46 vertebrae; 9–11 predorsal plates; 43–47 lateral line plates; smooth posterior margin of supraocular crest.

Internal diagnosis. *Brachyopsis* differs from other genera of Agonidae in possessing the following osteological characters: small articular facet on lachrymal; fifth and second infraorbitals attached to each other; no attachment between entopterygoid and metapterygoid; no ectopterygoid; no basihyal; attachment between prevomer and ethmoid; anterior articular facet on prefrontal; no pores between actinosts on pectoral girdle; inner pelvic keel; no pleural ribs; posterior insertion of pterygiophore; one spine on first dorsal pterygiophore; one epural.

Remarks. The genus *Brachyopsis* is represented by a single species, *B. segaliensis*, which is confined to the Far Eastern region.

Brachyopsis segaliensis (Tilesius, 1809)
(Japanese name: Shichirou-uo)

Fig. 51.

Agonus segaliensis Tilesius, 1809, p. 216, pl. 14 (original description; type locality, Bay of Patience, Sakhalin).

Agonus laevigatus Tilesius, 1813, pp. 436-439 (description).

Agonus rostratus Tilesius, 1813, pp. 448-454, pl. 14 (locality, Aniwa Bay).

Phalangistes laevigatus. Tilesius in Pallas, p. 116 (short description).

Phalangistes fusiformis Tilesius in Pallas, p. 116 (short description; substitute name).

Aspidophorus rostratus. Cuvier in Cuvier and Valenciennes, 1829, p. 212 (description).

Aspidophorus laevigatus. Cuvier in Cuvier and Valenciennes, 1829, p. 214 (description).

Aspidophorus segaliensis. Griffith, 1834, p. 153, fig. 1 (description).

Brachyopsis rostratus. Gill, 1862c, p. 167 (listed).

Leptagonus rostratus. Jordan and Gilbert, 1883, p. 955.

Siphagonus segaliensis. Jordan and Gilbert, 1883, p. 723 (short description).

Brachyopsis segaliensis. Jordan and Starks, 1895, p. 816.

Syngnathus segaliensis. Tanaka, 1931, p. 46 (listed).

Diagnosis. See account of the genus *Brachyopsis*.

Counts. D. VII-IX-7-9; A. 12-15; PI. 14-15; P2. I, 2; C. 6+5; Br. 6; V. 42-46; LLP. 43-47; Gr. 1-2+9-12; PP. 9-11; MDR. 1-10; DLR. 33-42; SLR. 33-38; ILR. 39-43; VLR. 31-37; MVR. 3-8.

Proportional measurements. Head 4.2-4.8 in SL; predorsal 2.6-3.0; pectoral fin 4.8-5.7; pelvic fin 9.0-13.7; caudal fin 6.9-9.0. Snout 2.7-3.4 in HL; orbit diameter 4.8-6.8; interorbital width 9.1-14.6; dorsal fin 2.1-3.5; anal fin 2.6-3.5. Body width 0.7-0.9 in its depth. Width of caudal peduncle 0.7-0.9 in its depth. Pelvic-anus length 3.1-7.2 in pelvic-anal length.

Body slender, compressed. Head moderate in size, triangular in dorsal aspect, smooth. A low knob on parietal. Supraocular crest ending as smooth margin, without serrations or spines. Nasal bones without spines, never attached to each other. Nasal tube short. Snout elongate, tubular. Posttemporal ridge prominent, without spines. No ethmoidal spine. Lower jaw projecting forward beyond upper one. Maxillary without barbel or flap, never reaching anterior margin of orbit. Eye moderate in size, without spines on upper part. Interorbital narrow, concave. Lachrymal with two blunt projections. Second infraorbital with a small spine or a knob. Preopercular spines three, upper two large and sharp, lowermost small and blunt. Opercle with a spine. Gill membranes united, free from isthmus. Teeth

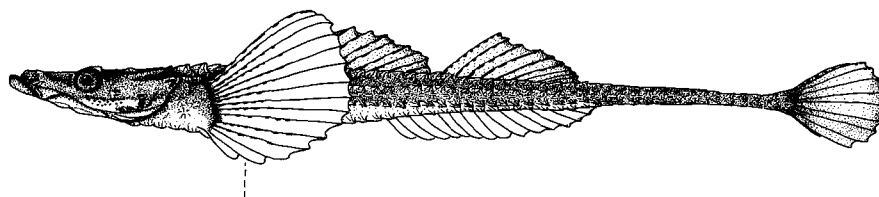

Fig. 51. *Brachyopsis segaliensis* (Tilesius): HUMZ 52831, 171.0 mm SL.

on jaws and prevomer, no teeth on palatine.

Two dorsal fins separated by a deep notch. Dorsal fin originating at tenth dorsolateral plate. Anal fin origin below eighth dorsal spine. Pectoral fin large, reaching fifth dorsal spine. Pelvic fin short. Caudal fin round.

Body covered with bony plates with a small blunt spine. No spine on plates of middorsal and midventral rows, lateral line, and breast. Tiny plates with a needle-like spine surrounding anus and scattered along midventral between anus and anal fin origin. Cheek with tiny spinous plates. Small bony plates on gular region, without spines.

Color. In preserved specimens, body brown, darker dorsally, paler ventrally. All fins pale, except for caudal fin. Pectoral fin with dark dots on fin rays. Dorsal fin somewhat darker marginally, five to seven dots on rays. Caudal fin dark, uppermost principal ray with eight dots.

Distribution. Peter the Great Bay north to Gulf of Tartary; Aniwa Bay and Terpeniye Bay, Sakhalin; Pacific and Okhotsk coasts of Hokkaido; Kuril Is.; Petropavlovsk, eastern coast of Kamchatka.

Remarks. *Brachyopsis* contains two nominal species, *B. segaliensis* and *B. rostratus*. *B. rostratus* was synonymized with the former by Schmidt (1950), after comparison of the original descriptions. The same view, which was followed by Lindberg and Krasnyukova (1987), is adopted here.

Materials. 19 specimens, 64.7-217.0 mm SL. HUMZ 5558, off Poronaysk (49°12'N, 143°04'E), Terpeniye Bay; HUMZ 5564, Aniwa Bay (Korsakov Aquarium), Sakhalin; HUMZ 15536, Funka Bay, Hokkaido; HUMZ 48644, Odaitou, Hokkaido, 22 September 1975; HUMZ 41304, off Mori, Funka Bay, 18 April 1975; HUMZ 52031, off Nanae-hama, near Hakodate, Hokkaido, 14 July 1976; HUMZ 52831, off Mori, 2 May 1976; HUMZ 75450, off Kawajiri, Oomu-cho, Okhotsk coast of Hokkaido, depth 5 m, 23 August 1977; HUMZ 80718, 80720, Akkeshi Bay, Pacific coast of Hokkaido; HUMZ 80725, 80732, Akkeshi Bay, 6 July 1978; HUMZ 80753, 80756, off Monsei, Akkeshi Bay, 27 November 1978; HUMZ 80907, 80908, 80911, Akkeshi Bay, 22 June 1978; HUMZ 82472, 82473, off Usujiri, Pacific coast of Hokkaido, 23 July 1975.

Genus *Pallasina* Cramer, 1895

Pallasina Cramer in Jordan and Starks, 1895, pp. 815-816 (type species, *Siphagonus barbatus* Steindachner).

External diagnosis. *Pallasina* is distinguished from other genera of the family Agonidae in having the following characters: two dorsal fins; 5-8 dorsal fin spines; 6-9 dorsal fin rays; 9-12 anal fin rays; 10-13 pectoral fin rays; no snout barbel; short nasal tube, never reaching upper jaw; nasal bones never attached to each other; no nasal spine; no rostral plate; nasal bone never beyond upper jaw; no ethmoidal spine; parietal with one low knob; upper jaw included in lower one; maxillary without barbel or flap; a barbel on lower jaw tip; teeth on jaws, prevomer and palatine; five branchiostegal rays; no occipital pit; interdorsal distance 3.9-21.2 in HL; 44-49 vertebrae; 12-14 predorsal plates; 47-52 lateral line plates; posterior margin of supraocular crest smooth.

Internal diagnosis. *Pallasina* differs from other genera of Agonidae in possessing the following osteological characters: small articular facet on lachrymal; fifth and second infraorbitals attached to each other; no attachment between entoptery-

goid and metapterygoid; no ectopterygoid; no basihyal; attachment between prevomer and ethmoid; anterior articular facet on prefrontal; no pores between actinosts on pectoral girdle; inner pelvic keel; no pleural ribs; posterior insertion of pterygiophore; one spine on first dorsal pterygiophore; one epural.

Remarks. *Pallasina* is represented by a single species, *P. barbata*, which is widespread from the coast of California, through the Bering and Okhotsk seas, to the coast of northern Japan and Wonsan, Korea.

Pallasina barbata (Steindachner, 1877)

(Japanese name: Yagi-uo)

Fig. 52.

Siphagonus barbatus Steindachner, 1877, pp. 188-192, pl. 5 (original description; type locality, Arctic near Bering Strait, Hakodate and Nagasaki in Japan).

Pallasina barbata. Jordan and Starks, 1895, pp. 815-816 (listed).

Pallasina aix Starks, 1896, pp. 558-560, pl. 75 (locality, Puget Sound, near Port Ludlow).

Pallasina eryngia Jordan and Richardson, 1908, pp. 264-265, fig. 2 (original description; type locality, coast of Echigo, Japan).

Pallasina barbata aix. Schults, 1936, p. 183 (key; Aleutian to coast of Oregon).

Pallasina barbata barbata. Taranetz, 1937, p. 123 (key).

Diagnosis. See account of the genus *Pallasina*.

Counts. D. V-VIII-6-9; A. 8-13; P1. 10-13; P2. I, 2; C. 5-6+4-5; Br. 5; V. 42-52; LLP. 44-54; Gr. 1+10-12; PP. 10-14; MDR. 3-12; DLR. 30-46; SLR. 33-52; ILR. 39-48; VLR. 28-42; MVR. 3-10.

Proportional measurements. Head 3.8-5.0 in SL; predorsal 2.2-2.5; pectoral

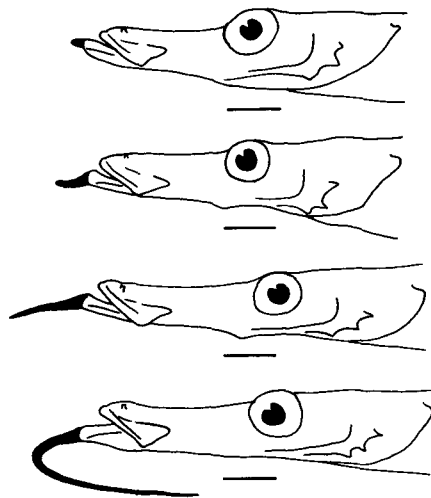

Fig. 52. Lower jaw barbel of *Pallasina barbata* (Steindachner). top to bottom, BCPM 978318 (James I.), HUMZ 69037 (Bering Sea), HUMZ 92862 (off Oomu, Okhotsk coast of Hokkaido), HUMZ 93970 (off Usujiri, Funka Bay). Scale bars indicate 2 mm.

fin 5.1-7.0; pelvic fin 10.4-32.0; caudal fin 7.1-10.9. Snout 2.1-2.7 in HL; orbit diameter 5.5-7.1; interorbital width 7.6-15.0; dorsal fin 2.6-4.1; anal fin 2.1-3.5. Body width 0.7-1.1 in its depth. Width of caudal peduncle 0.7-1.1 in its depth. Pelvic-anus length 4.2-15.9 in pelvic-anal length.

Body cylindrical, depressed. Head moderate in size, smooth without spines. Frontal-parietal ridges parallel with each other. A low knob on parietal. Supraocular crest ending as smooth margin, without spines. Nasal bones never attached to each other, without spines. Nasal tube short, never reaching upper jaw. Snout prolonged, tubular. Temporal ridge smooth, ending as a posttemporal spine or a knob. No ethmoidal spine. Lower jaw projecting forward beyond upper one, with a barbel on its tip. Lower jaw barbel various, 0.8-154.0 in HL. Maxillary without barbel or flap, reaching half length of snout. Eye small, without bony tubercles. Interorbital narrow, elevated dorsal rim of orbit. Free lachrymal margin smooth without spines. Second infraorbital with a knob. Preopercular spines three, weak, upper two sharper than lowermost. Gill membranes united, free from isthmus. Villiform teeth in bands on jaws, prevomer and palatine.

Dorsal fins two. Interdorsal distance variable, 3.9-21.2 in HL. Anal fin originating below middle part of first dorsal fin base. Pectoral fin sublateral, upper two or three rays longest. Pelvic fin small. Caudal fin round.

Plates of dorsolateral, supralateral, infralateral and ventrolateral rows, with a blunt spine or a knob. No spine on plates of breast, middorsal and midventral rows, and lateral line. Origin of supralateral plates below dorsal origin or slightly posterior. Cheek covered with a row of plates (3-6). Subpectoral region smooth, with a single plate or lacking. Gular region with plates.

Color. In preserved specimens, body brown, darker dorsally, paler ventrally. A stripe on head, from tip of snout, through part between temporal ridge and uppermost preopercular spine, to posterior upper part of opercle. Fins pale, except for caudal fin. Caudal fin dark. Tiny spots on dorsal and pectoral fin rays. Mouth and gill cavities and peritoneum pale.

Sexual dimorphism. Pelvic fin longer in male (10.4-18.7 in SL) than those in female (16.1-32.0).

Distribution. Japan Sea, south to Wonsan, Korea; Pacific coast of Northern Japan; Okhotsk coast of Hokkaido; southern coast of Sakhalin; Kuril Is.; Bering sea; Alaska to Cleon Beach of California; Arctic Sea.

Remarks. *Pallasina barbata* was firstly described, as *Siphagonus barbatus* by Steindachner (1877), based on the specimens from the Arctic, and Hakodate and Nagasaki in Japan. After Steindachner's original description, Starks (1896) established *P. aix* from Puget Sound, and *P. eryngia* was described by Jordan and Richardson (1908), on the basis of specimens from Echigo, Japan.

The three species have previously been differentiated by the number of pectoral fin rays, the length of the lower jaw barbel, and the number of prepelvic plates. In fact, the length of the lower jaw barbel varies, from very short or absent, off the west coast of North America, to long in northern Honshu, Japan (Table 7). The number of pectoral fin rays is also variable, the mode being 11 in southern regions, and 12-13 in northern regions. The third character, the number of prepelvic plates, varies from two to three. Accordingly, it is considered that *P. aix* and *P. eryngia* are

Table 7. Intraspecific variation in *Pallasina barbata*.

	Northern Honshu	Hakodate	Sakhalin and Abashiri	Tomakomai to Odaitou	Alaska and Bering Sea	British Columbia
Number of specimens	5	7	12	9	5	10
Standard length (mm)	72.8-208.0	58.8-166.0	93.5-147.2	69.4-104.5	80.8-141.0	58.5-128.2
Length of lower jaw barbel in head length	0.8-1.7	0.9-2.2	1.9-4.5	8.4-22.0	10.0-19.7	17.5-154.0
Counts						
Dorsal spines	5-6	6	5-6	6-8	6-8	5-8
Dorsal rays	7-8	6-9	6-9	6-8	6-8	6-8
Anal rays	8-11	9-12	9-11	9-11	9-13	10-12
Pectoral rays	10-11	11	11-12	11-13	12-13	11
Vertebrae	51	49-52	47-49	46-49	44-48	42-47
Lateral line plates	50-52	50-54	48-52	47-50	47-50	44-48
Predorsal plates	12-14	13-14	12-14	11-13	12	10-12
Middorsal plates	6-9	3-10	7-12	5-10	5-11	8-12
Dorsolateral plates	41-43	40-46	36-42	37-43	36-40	30-37
Supralateral plates	36-37	48-52	35-50	33-48	46-48	42-46
Infralateral plates	45-48	45-47	44-47	42-45	40-44	39-43
Ventrolateral plates	38-41	38-42	34-39	35-40	35-37	28-36
Midventral plates	4-6	3-8	6-10	4-9	4-10	4-10

junior synonyms of *P. barbata*.

P. barbata inhabits shallow waters, living on the seaweeds covered and sandy bottoms.

Materials. 48 specimens, 58.5–208.0 mm SL. BCPM 978241, 48°35.8'N, 123°21.3'W, James I., 21 July 1978; BCPM 978318, 48°39'N, 123°22'W, 26 October 1978; BCPM 974401, 54°47'58"N, 130°25'21"W, Head of Winter Inlet, 9 June 1974; HUMZ 5624, off Nesaki, near Hakodate; HUMZ 21294, off Oodomari, Sakhalin; HUMZ 51945, off Awashima, Niigata Pref., March 1976; HUMZ 62426, 62430, Mano Bay, Sado I., depth 8.5–10.5 m, by beam trawl, 24 May 1972; HUMZ 62502, 62504, Odaitou, Hokkaido, 9 November 1976; HUMZ 64805, 64808, off Horonai, Hokkaido, 30 m, by beam trawl, 24 May 1977; HUMZ 64810–64813, off Kawajiri, Oomu-cho, Hokkaido, 70 m, 27 July 1977; HUMZ 69031, 69037, 58°23'N, 160°00'W, 19 m, Bering Sea, by trawl of Wakatori Maru II, 8 May 1973; HUMZ 69032, 58°15'N, 158°30'W, Bering Sea, 28 m, 9 May 1973; HUMZ 80748, 80749, off Monsei, Akkeshi Bay, Hokkaido, 27 November 1978; HUMZ 82475, 82476, off Usujiri, Hokkaido, by beach sein, 23 July 1975; HUMZ 88097, off Monsei, 5 October 1978; HUMZ 91010, 91011, off Masuura, near Abashiri, by beam trawl, 2 June 1981; HUMZ 91979, off Oomu, Okhotsk coast of Hokkaido, 30 m, by beam trawl, 11 July 1981; HUMZ 92763, off Tomakomai, 7 m, by beam trawl, 1 October 1981; HUMZ 92764–92766, off Oshirabetsu, near Hiroo, 23 m, by beam trawl, 26 November 1981; HUMZ 92862, off Oomu, by beam trawl for shrimp, 13 July 1981; HUMZ 92967, off Oomu, 35 m, 19 August 1981; HUMZ 93968–93970, off Usujiri, by set net, 13 October 1981; HUMZ 94354, off Usujiri, 2 May 1982; IFES 437, off Ozaki east to 6 miles, Iwate Pref., 8 October 1970; UBC 59484, Zachar Bay, Alaska, 1 June 1957; uncatalogued specimen of Uozu Aquarium, Toyama Bay.

V. Systematic methodology

1. Application of cladistics

In modern systematics, relationships can be inferred by evolutionary systematics (Mayr, 1969), cladistics (Hennig, 1966), and phenetics (Sneath and Sokal, 1973). In the present study, the cladistic approach was adopted, because of the logical consistency of repeatability and objectivity in classification.

2. Procedures

The study was carried out along the following procedures:

- (1) Collection of comparative morphological data
- (2) Determination of polarity of character
- (3) Inference of branching pattern
- (4) Taxonomic ranking

(1) Collection of comparative morphological data

Morphological characters, mainly osteological characters, selected from the following: circumorbital bones, jaws, suspensorium and opercular apparatus, hyoid apparatus, branchial apparatus, cranium, pectoral girdle, pelvic girdle, vertebrae and pterygiophores, and caudal skeleton.

(2) Determination of polarity of character

Polarity of character in agonid fishes was determined on the basis of the distributional pattern of the character states in agonid fishes and related groups.

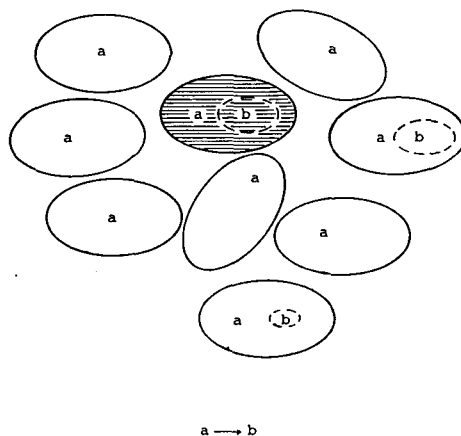

Fig. 53. Distribution pattern of two character states in the monophyletic group (\ominus) and its relatives (\circ). a, primitive condition; b, derived condition.

This is the criterion of commonality (Hecht and Edwards, 1977).

The distributional pattern of character states is considered to be continually changing with time. At first, the primitive state "a" changes into the derived state "b" in a limited group. State "b" gradually becomes more widespread as new species evolve. Subsequently, a third state "c" is derived from state "b", which gradually becomes less common. Thus, the distributional range of a character state in-group or out-group differs according to the age of the taxon, and the polarity of the character can be determined from distribution of in- and out-group character states, as shown in Fig. 53. When, in related groups, widely distributed character state "a" and narrowly distributed "b" are observed, state "b" in the monophyletic group is considered to be the derived condition.

(3) Inference of branching pattern

The construction of a branching pattern (cladogram) is one of the important aspects of phylogenetic systematics. Hennig (1966) introduced the concept of 'sister groups'. This concept is defined as follows: species groups that arose from stem species of a monophyletic group by one and the same splitting process may be called a "sister group." Sister groups are characterized by the concept of synapomorphy, which is used to infer a monophyletic group. The number of synapomorphies is one of the operational principles on which the cladogram is constructed.

In the present study, the branching patterns of agonid fishes are constructed according to the following principles (Fig. 54):

- 1) the terminal taxon is a species;
- 2) in a group, contemporary taxa A and B are connected by the largest number of synapomorphies;
- 3) the character condition in the common ancestral taxon, P1, is inferred from the character state in taxa A and B. For example, when the character 2 of taxon A represents the derived condition, and that of taxon B is the primitive condition,

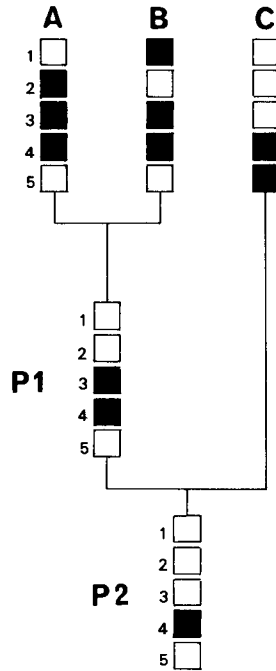

Fig. 54. Determination of the branching pattern of contemporary taxa A, B and C. Open squares indicate primitive state. Solid squares indicate derived state.

the character state of the ancestral taxon, P1, is considered to be primitive ;

4) from the remaining taxa, taxon C, having the largest number of synapomorphies with P1, is selected and connected, and the ancestral taxon P2 is inferred ;

5) the above operation is conducted repeatedly, and a cladogram obtained, without resort to the parsimony principle.

(4) Taxonomic ranking

In Linnean systematics, organisms are classified for the purpose of identification and information retrieval (L ϕ vtrup, 1976). Phylogenetic classification deals with the history of the evolutionary process, with hierarchy being represented in a cladogram. To account for the relationships between taxa, which are descendants of the same ancestral taxon, Hennig (1966) proposed the concept of 'sister groups,' and suggested that they are given equal rank.

A cladogram is basically a dichotomous dendrogram. Each bifurcation involves a taxonomic rank. As far as taxonomic ranking is concerned, this implies a radical change from Linnean systematics.

In the present study, to minimize confusion between Linnean systematics and phylogenetic systematics, hierarchical ranks are determined conventionally on the basis of careful consideration of the previous (Linnean) hierarchical levels.

VI. Comparative morphology

Unless otherwise stated, all bones referred to be paired in the following section.

1. Circumorbital bones (Figs. 55-58 ; Table 8)

Description. Agonid circumorbital bones comprise a series lying on the lower and posterior margins of the orbit, and consisting of one lachrymal and three infraorbital bones. The number of these elements is stable and there is no intrafamilial variation. The second infraorbital bone, which covers the majority of the cheek region, is tightly attached to the preopercular ridge at its posterior margin.

Lachrymal: The lachrymal is star-like shaped in *Hypsogonus* and *Percis*, rectangular in *Tilesina*, *Brachyopsis* and *Pallasina*, fan-like in *Occella*, *Chesnonia* and *Stellerina*, and shoe-like in other agonids. This bone is located at the anterior-most position in the circumorbital bones, and is slightly smaller than the second infraorbital. It is attached anteriorly to the palatine, anterodorsally forms the lower margin of the nasal cavity, posterodorsally articulates with the prefrontal, and posteriorly sutures tightly with the first infraorbital. The free lachrymal margin partly includes the upper jaw. The articular facet of this bone with the prefrontal is large, and has a medial process in most agonid fishes. However, in *Pallasina* and *Brachyopsis*, the facet is tiny and without a process (Figs. 57E and F). In *Podothecus*, the bone has a well-developed anteromedial flange (Fig. 55F). A connection between the nasal and the lachrymal is present in the majority of agonids, but these two bones are widely separated from each other and indirectly connected by a ligamentous membrane in *Hypsogonus*, *Percis*, *Stellerina*, *Chesnonia*, *Occella*, *Tilesina*, *Brachyopsis* and *Pallasina* (Figs. 55 and 57). In *Freemanichthys*, the anterodorsal portion of the lachrymal is well expanded and margins the ventrolateral side of the nasal cavity. Such an expansion is absent in *Hypsogonus*, *Percis*, *Bothragonus*, *Odontopyxis*, *Ulcina*, *Aspidophoroides*, *Anoplagonus*, *Tilesina*, *Brachyopsis* and *Pallasina*, and is only slightly developed in other agonid fishes.

First infraorbital: The first infraorbital is a small bone connecting the lachrymal and the second infraorbital. The lateral aspect is triangular in *Podothecus* and *Bothragonus*, rectangular in *Freemanichthys*, *Leptagonus* and *Agonus* (Figs. 55G, H, and 56A), and slender anteroposteriorly in other agonids. In *Pallasina* and *Brachyopsis*, it is loosely attached to the second infraorbital or separated for a short distance from it (*Pallasina* only), but in other agonids it is tightly attached. The bone bears a well-developed mediolateral shelf in *Bathyagonus* and *Xenertmus* (Figs. 56B and C). Such a shelf is slightly developed anteriorly in *Odontopyxis* and *Agonopsis*, and posteriorly in *Percis matsuii*. Other agonids lack a shelf altogether.

Second infraorbital: The second infraorbital is the largest of the circumorbital bones, and bears a well developed stay. It connects with the first infraorbital anteriorly and the preopercular ridge posteriorly, and carries the fifth infraorbital on its dorsal portion in the entire family, except for *Hypsogonus quadricornis*, *H. corniger* and *H. mozinoi*, which lack a direct attachment between the second and fifth infraorbitals. In *Freemanichthys*, *Podothecus*, and *Agonus*, the second infraorbital covers almost all of the cheek region and reaches the lower preopercular ridge.

Fifth infraorbital: The fifth infraorbital is tubular, and is the smallest of the

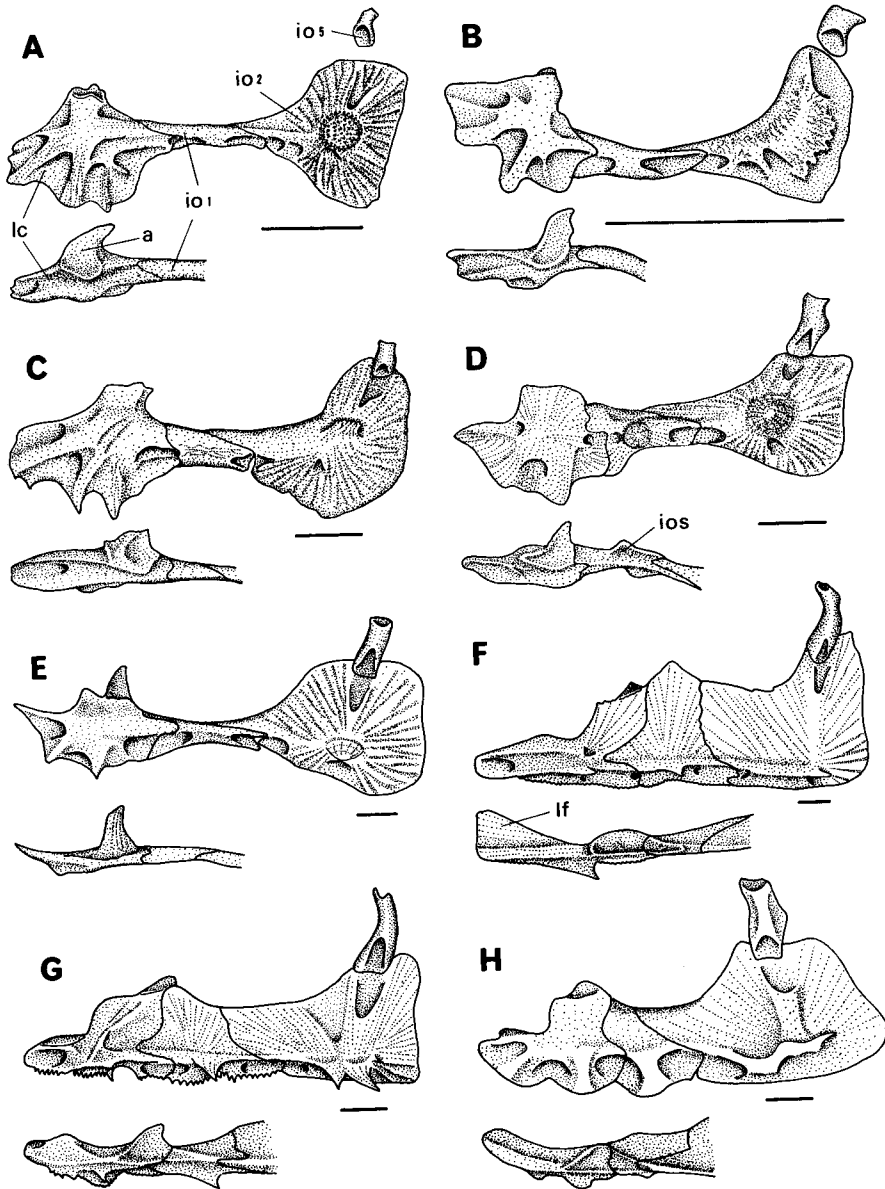

Fig. 55. Lateral and dorsal aspects of the circumorbital bones in the family Agonidae. A, *Hypsagonus quadricornis*; B, *H. mozinoi*; C, *H. proboscidalis*; D, *Percis matsuii*; E, *P. japonicus*; F, *Podothecus acipenserinus*; G, *Freemanichthys thompsoni*; H, *Agonus cataphractus*. a, articular facet; io 1, 2 and 5, first, second and fifth infraorbitals; ios, infraorbital shelf; lc, lachrymal; lf, lateral flange. Scale bars indicate 3 mm.

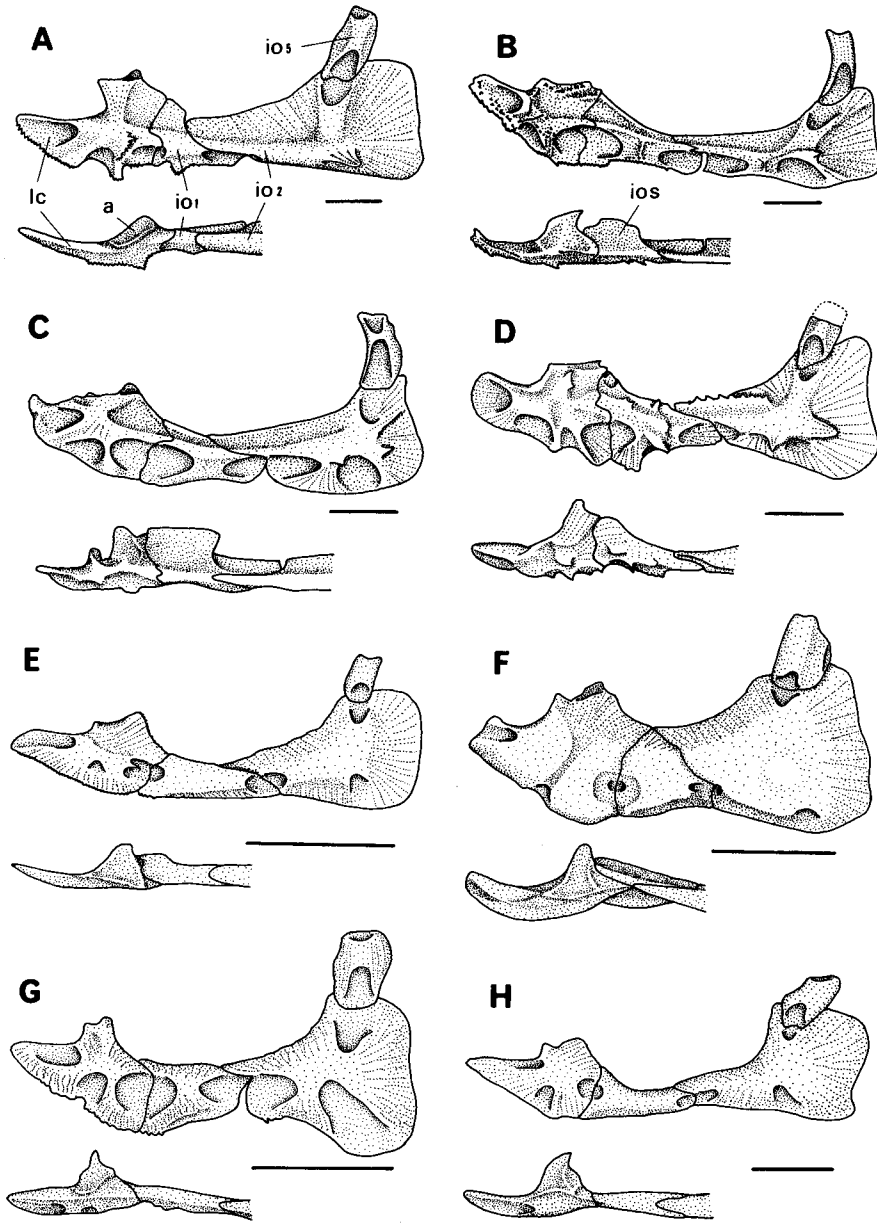

Fig. 56. Lateral and dorsal aspects of the circumorbital bones in the family Agonidae. A, *Leptagonus decagonus*; B, *Bathyagonus nigripinnis*; C, *Xenertmus latifrons*; D, *Agonopsis vulsa*; E, *Odontopyxis trispinosa*; F, *Bothragonus swani*; G, *Ulcina oltriki*; H, *Aspidophoroides monopterygius*. Scale bars indicate 3 mm. (abbreviations, see Fig. 55).

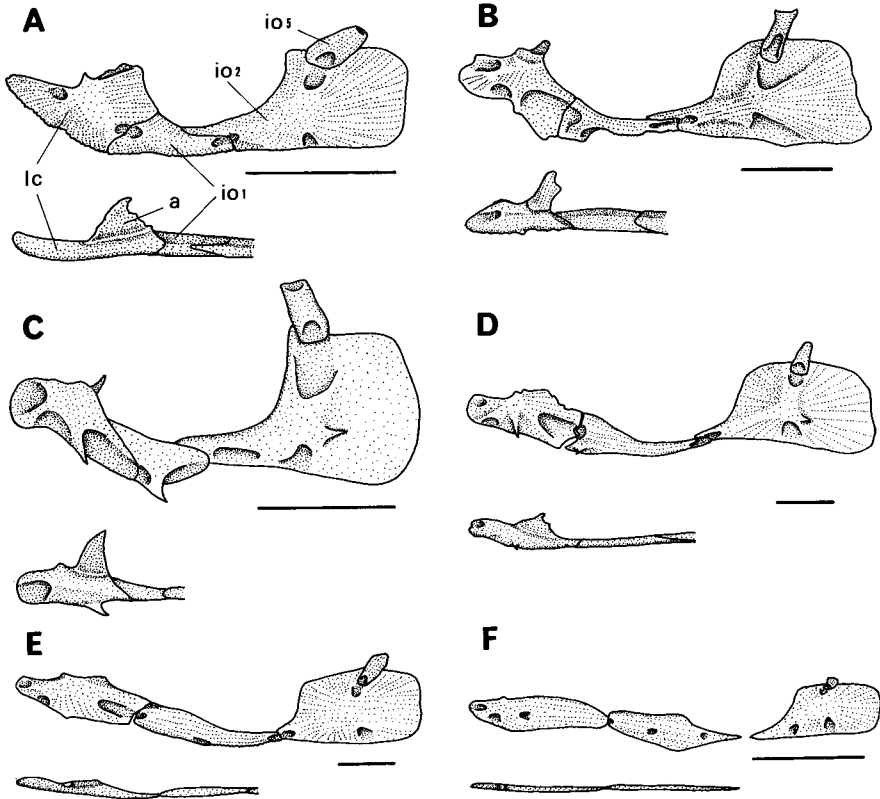

Fig. 57. Lateral and dorsal aspects of the circumorbital bones in the family Agonidae. A, *Anoplagonus inermis*; B, *Occella dodecaedron*; C, *Stellerina xyosterna*; D, *Tilesina gibbosa*; E, *Brachyopsis segaliensis*; F, *Pallasina barbata*. Scale bars indicate 4 mm. (abbreviations, see Fig. 55).

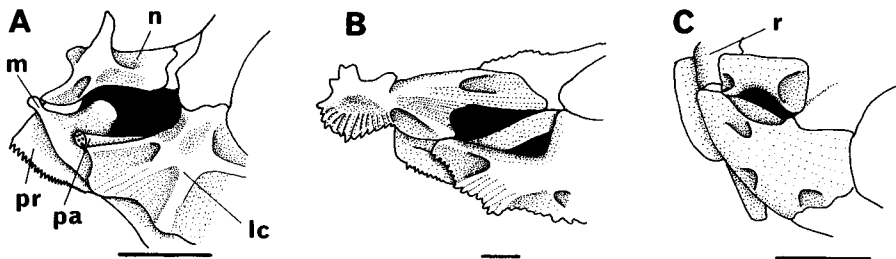

Fig. 58. Relationship between the lachrymal, nasal bone and rostral plate. A, *Hypsagonus quadricornis*; B, *Leptagonus frenatus*; C, *Anoplagonus inermis*. lc, lachrymal; m, maxillary; n, nasal bone; pa, palatine; pr, premaxillary; r, rostral plate. Scale bars indicate 2 mm.

Table 8. Comparison of the circumorbital bones and character states in the family Agonidae. AB, attachment between lachrymal and nasal; AF, articular facet of lachrymal; CC, cheek cover of infraorbitals; FI, first infraorbital shelf; LF lateral flange of lachrymal; RB, relation between 2nd and 5th infraorbitals. D, derived; P, primitive.

AF		LF		AB		FI		RB		CC		taxa
large	P	absent	P	absent	P	absent	P	separate	P	incomplete	P	Hypsagonus quadricornis H. corniger, H. mozinoi
								attach	D			H. proboscidalis H. jordani Percis japonicus Stellerina, Occella Chesnonia, Tilesina
								present posteriorly	D			Percis matsuii
						present	D1	absent	P			Leptagonus
						present with rostral plate	D2	present anteriorly	D			Bothragonus, Ulcina Aspidophoroides Anoplagonus
						present	D1					Odontopyxis
						absent	P	complete	D			Freemanichthys, Agonus
		present	D	Podothecus								
small	D	absent	P	absent	P			incomplete	P	Brachyopsis, Pallasina		

circumorbital bones. It tightly attaches with the sphenotic on its upper half, and with the second infraorbital on its lower half, except for *Hypsagonus quadricornis*, *H. corniger* and *H. mozinovi* (Figs. 55A and B).

Discussion. The Agonidae is characterized by having a lachrymal, and the first, second, and fifth infraorbitals.

In the Scorpaeniformes, the circumorbital bones generally consist of six elements, the lachrymal, and five infraorbitals. The first and second infraorbitals are large, and the third to fifth are small. The fifth infraorbital is always attached to the sphenotic.

In scorpaeniform fishes, the anterior three circumorbital bones, a lachrymal and the first and second infraorbitals, are always present, except in the Caracanthidae, which has one large infraorbital, which appears to be a fusion of the first and second infraorbitals. The status of the third to the fifth infraorbitals are variable, three to absent in the order (Allis, 1909; Taranetz, 1941; Taliev, 1955; Matsubara and Ochiai, 1955; Watanabe, 1958; Quast, 1965; Yabe, 1981).

Examination of agonid circumorbitals disclosed the following interspecific variations: character 1, size of articular facet of lachrymal; character 2, condition of lateral flange on lachrymal; character 3, relationship between lachrymal and nasal; character 4, condition of shelf on first infraorbital; character 5, relationship between second and fifth infraorbitals; character 6, condition of cheek cover by infraorbitals (Table 8). These characters were polarized as follows.

Character 1: size of articular facet of lachrymal. The articular facet of the lachrymal is large and well developed in most agonid fishes. However, *Brachyopsis* and *Pallasina* have a small articular facet. Thus, there are two character states for this articular facet in agonid fishes. On the other hand, in the majority of scorpaeniform fishes examined, the facet was large and well-developed. It is therefore considered that a large articular facet represents the primitive state.

Character 2: condition of lateral flange on lachrymal. This element was observed only in *Podothecus* among the genera of Scorpaeniformes, as far as examined. Thus, the presence of this flange is an unique character state, and is therefore believed to be an unique derived condition. In *Podothecus*, the flange appears to support the well-projecting snout beyond upper jaw.

Character 3: relationship between lachrymal and nasal. Concerning the attachment between the lachrymal and nasal bones, there are three states in agonid fishes. It is absent in *Hypsagonus*, *Percis*, *Stellerina*, *Chesnonia*, *Ocella*, *Tilesina*, *Brachyopsis* and *Pallasina*, but present in *Leptagonus*, *Agonus*, *Freemanichthys*, *Podothecus*, *Agonopsis*, *Bathyagonus* and *Xenertmus*. Furthermore, in *Bothragonus*, *Odontopyxis*, *Ulcina*, *Aspidophoroides* and *Anoplagonus*, the lachrymal is attached directly to both the nasal bone and the rostral plate. An attachment between the lachrymal and nasal bones does not occur in the most Scorpaeniformes, except for *Alertichthys* (Congiopodidae), Triglidae and Peristediidae. Therefore, it is considered that the absence of an attachment represents the primitive state, and its presence, the derived state. An even more derived state is thought to be the attachment of the lachrymal, the nasal bone and the rostral plate.

Character 4: condition of shelf on first infraorbital. The shelf is present posteriorly on the first infraorbital in *Percis matsuii*, and anteriorly in *Odontopyxis*,

Agonopsis, *Bathyagonus* and *Xenertmus*. There is no shelf on the first infraorbital in other agonid fishes. In the majority of Scorpaeniformes, such a shelf is absent. Therefore, presence of a shelf is considered to be the derived state.

Character 5: relationship between second and fifth infraorbitals. An attachment between the second and fifth infraorbitals is absent in *Hypsagonus quadricornis*, *H. corniger* and *H. mozinoi*, but present in other agonid fishes. In Scorpaeniformes, the second infraorbital is separated from the fifth. Thus, the presence of an attachment between the second and fifth infraorbitals is considered to be the derived state.

Character 6: condition of cheek cover by infraorbitals. In most agonid fishes, the cheek region is incompletely covered by the first and second infraorbitals. However, in *Agonus*, *Freemanichthys* and *Podothecus*, this region is completely covered by the infraorbitals, the lower margin of the latter being tightly attached to the preopercular ridge. The cheek is slightly covered by the infraorbitals in the Scorpaeniformes, except for Triglidae and Peristediidae. These two families have the cheek completely covered by infraorbitals. Thus, it is considered that the cheek being completely covered by infraorbitals, is the derived state.

2. Jaws (Figs. 59-62, Table 9)

Description. The agonid upper jaw consists of two elements, a premaxillary and maxillary. The lower jaw consists of a dentary, an angular, a retroarticular, and a coronomeckelian.

Premaxillary: The premaxillary borders the upper margin of the mouth, and is L-shaped in lateral view. It has a premaxillary pedicel directed posterodorsally and an alveolar process, making the base of L-shaped bone. In the Agonidae, the premaxillary pedicel is well developed, and subdivided into two parts by a deep cleft. The anterior part is an ascending process which tapers distally, and the posterior part is an articular process, which is spatula-like in shape. The articular process is rectangular in *Hypsagonus* and *Percis*, disk-like in *Podothecus*, and intermediate between these two extremes in other agonids. The ascending process is longer than the articular process, and also longer than the alveolar process in *Hypsagonus*, although it is of equal length or shorter in other agonids. Both ascending processes are attached to each other, and support a single rostral cartilage. The alveolar process is a well ossified bone, plate-like in *Hypsagonus*, *Percis* and *Aspidophoroides*, and stick-like shaped in other agonids. A postmaxillary process exists as a thin plate on the posterodorsal part of the alveolar process.

Upper jaw teeth are borne on the premaxillary. They are conical, occurring in bands in *Hypsagonus*, *Percis*, *Leptagonus*, *Ulcina*, *Aspidophoroides*, *Stellerina*, *Chesnonia* and *Occella*. In *Xenertmus*, the teeth are similarly in bands, but the outermost row of teeth are larger than those of the inner row. Villiform teeth occur in bands in *Bathyagonus*, *Tilesina*, *Brachyopsis* and *Pallasina*. In *Podothecus*, teeth may be absent or represented by a few only in *P. acipenserinus*, *P. veterinus* and *P. sturioides*. A single row of teeth is present in *P. sachi* and *P. hamlini*.

Maxillary: The maxillary is stick-like, and is excluded by the premaxillary from the mouth margin. Its anterior part, called the maxillary head, is saddle-like, and possesses three projections, the external and internal proximal limbs and the

cranial articular surface. The cranial articular surface is connected with the tip of the ascending premaxillary process by a ligament, and also with the cranial, by the ethmoid-maxillary ligament. Both inner and outer proximal limbs are stepped over the articular premaxillary process. The internal proximal limb articulates with an articular premaxillary process. Both limbs differ in developmental degree among species in the Agonidae. In *Hypsagonus*, *Percis*, *Leptagonus*, *Xenertmus* and *Aspidophoroides*, they are the same length. In *Podothecus*, the internal limb is the

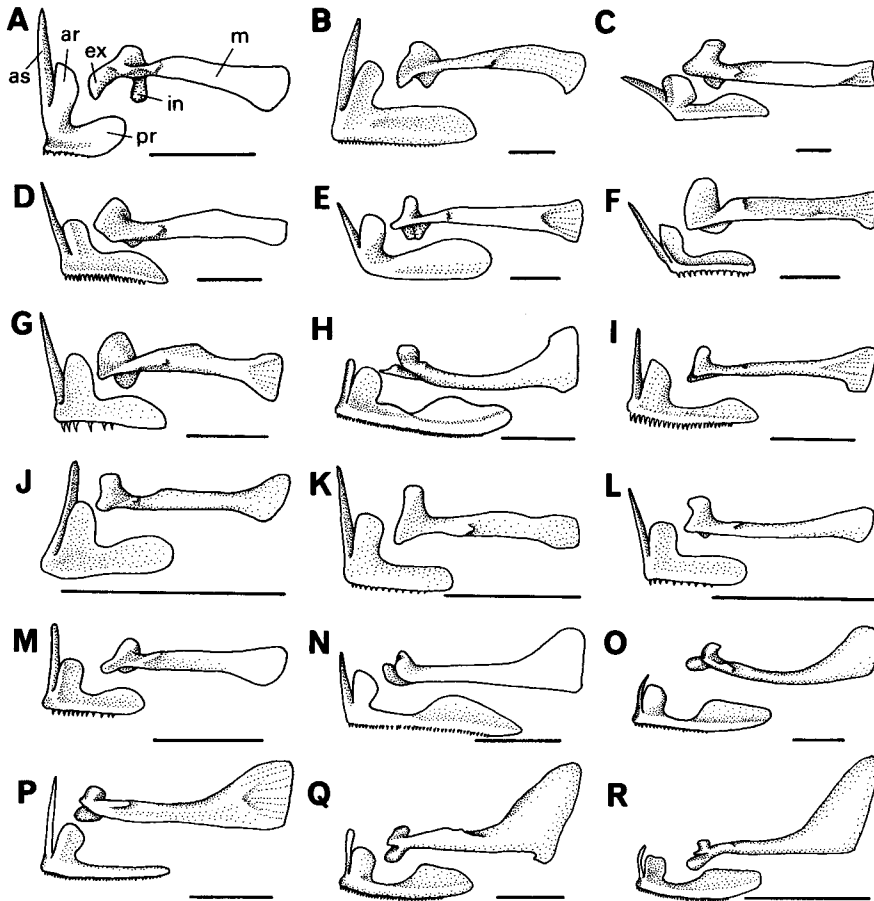

Fig. 59. Lateral aspect of the upper jaw in the family Agonidae. A, *Hypsagonus quadricornis*; B, *Percis japonicus*; C, *Podothecus acipenserinus*; D, *Agonus cataphractus*; E, *Leptagonus decagonus*; F, *Freemanichthys thompsoni*; G, *Agonopsis vulsa*; H, *BathYGONUS nigripinnis*; I, *Xenertmus latifrons*; J, *Odontopyxis trispinosa*; K, *Bothragonus swani*; L, *Ulcina olriki*; M, *Aspidophoroides monoptygius*; N, *Stellerina xyosterna*; O, *Tilesina gibbosa*; P, *Ocella dodecaedron*; Q, *Brachyopsis segaliensis*; R, *Pallasina barbata*. ar, articular process of premaxillary; as, ascending process of premaxillary; ex, external limb of maxillary; in, internal limb of maxillary; m, maxillary; pr, premaxillary. Scale bars indicate 3 mm.

more developed. In *Bathyagonus*, *Stellerina*, *Chesnonia*, *Ocella*, *Tilesina*, *Brachyopsis* and *Pallasina*, the internal limb is well developed, whereas the external limb is only slightly developed. The palatine prong is on the dorsal part of the maxillary, just behind the maxillary head.

The posterior part of the maxillary is thick and well ossified. The shape of the bone varies, being plate-like in *Hypsagonus*, *Percis*, *Agonus*, *Freemanichthys* and *Podothecus*, fan-like in *Leptagonus*, *Bothragonus*, *Odontopyxis*, *Xenertmus*, *Ulcina*, *Aspidophoroides* and *Anoplagonus*, and triangular in *Bathyagonus*, *Stellerina*, *Chesnonia*, *Ocella*, *Tilesina*, *Brachyopsis* and *Pallasina*.

Dentary : The dentary borders the lower margin of the mouth, which supports

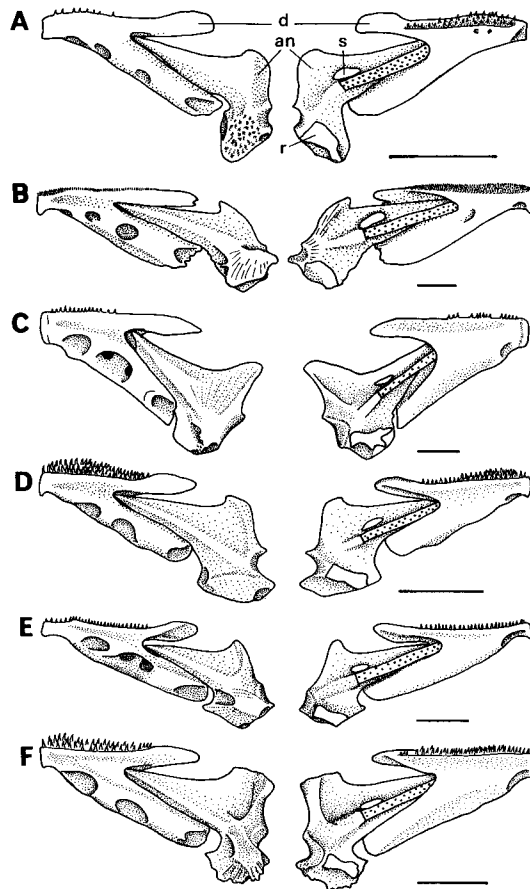

Fig. 60. Lateral and medial aspects of the lower jaw in the family Agonidae. A, *Hypsagonus quadricornis*; B, *Percis japonicus*; C, *Podothecus acipenserinus*; D, *Agonus cataphractus*; E, *Leptagonus decagonus*; F, *Freemanichthys thompsoni*. an, angular; d, dentary; r, retroarticular; s, coronomeckelian. Scale bars indicate 3 mm.

teeth along its dorsal surface. It is shoe-like in lateral view, and is sutured with its opposite number at the anterior tip. The dentary is divided into upper and lower limbs by a cleft on the posterior margin. The maxillary-mandibular ligament is attached to the posterior end of the upper limb. The lower limb is pierced by the sensory channel, and has four sensory pores. The angular is inserted between the upper and lower limbs. The dentary has a recurved upper margin in *Bathyagonus*, *Stellerina*, *Chesnonia*, *Occella*, *Tilesina*, *Brachyopsis* and *Pallasina*, and a straight margin in other agonids.

Angular: The angular is a triangular, paired bone, and is inserted into the V-shaped foramen of the dentary. The meckelian cartilage runs from the center of the medial side of the angular to the dentary notch. At its lower margin the angular articulates with the quadrate. It has an elongate, triangular shape in *Tilesina*,

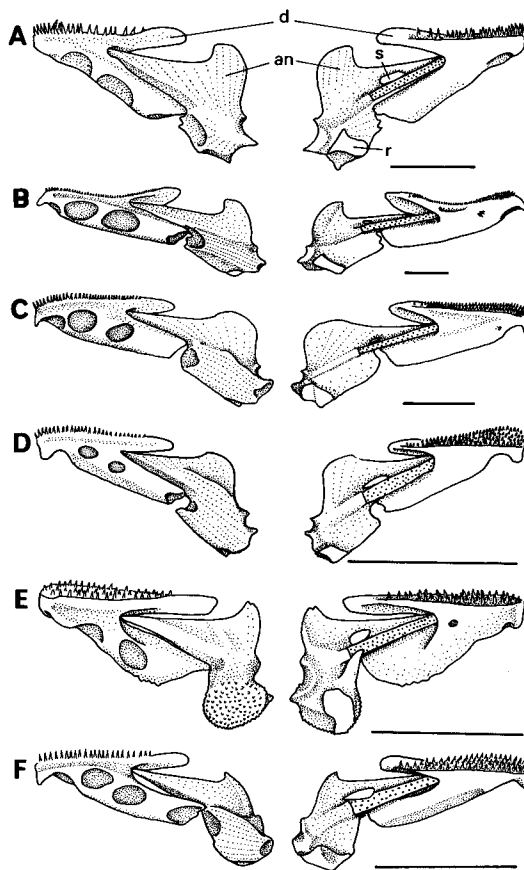

Fig. 61. Lateral and medial aspects of the lower jaw in the family Agonidae. A, *Agonopsis vulsa*; B, *Bathyagonus nigripinnis*; C, *Xenertmus latifrons*; D, *Odontopyxis trispinosa*; E, *Bothragonus swani*; F, *Ulcina olriki*. Scale bars indicate 3 mm. (abbreviations, see Fig. 60).

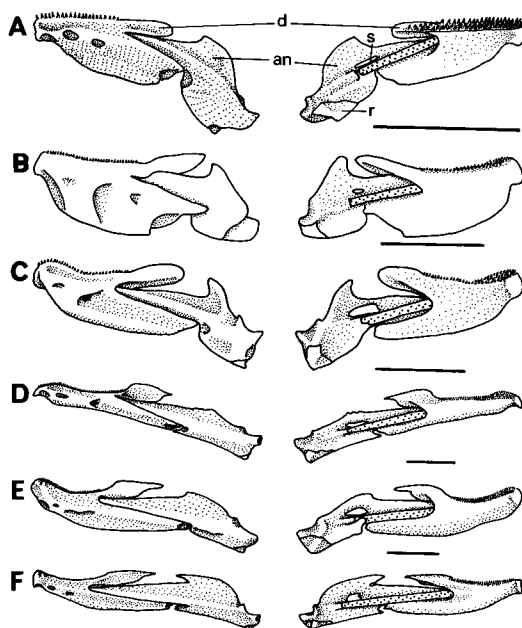

Fig. 62. Lateral and medial aspects of the lower jaw in the family Agonidae. A, *Aspidophoroides monopterygius*; B, *Stellerina xyosterna*; C, *Ocella dodecaedron*; D, *Tilesina gibbosa*; E, *Brachyopsis segaliensis*; F, *Pallasina barbata*. Scale bars indicate 5 mm. (abbreviations, see Fig. 60).

Brachyopsis and *Pallasina*, and is pistol like in other agonids.

Retroarticular: The retroarticular is small, bordering the posteroventral margin of the angular, and is tightly sutured to the articular. Its bone is square in *Hypsagonus*, *Percis*, *Podothecus*, *Xenertmus*, *Ulcina*, *Stellerina*, *Chesnonia*, *Ocella* and *Brachyopsis*, L-shaped in *Leptagonus* and *Bathyagonus*, and triangular in *Aspidophoroides*, *Anoplagonus*, *Tilesina*, *Brachyopsis* and *Pallasina*.

Coronomeckelian: The coronomeckelian is tiny and scale-like in shape. It is attached to the center of the medial side of the articular just above the meckelian cartilage, and supports a ligament of the adductor mandiblae muscle.

Relationship between upper and lower jaws: The upper and lower jaws are equal in length in most agonid species. The lower jaw is included in the upper one, being far from each other in *Podothecus*, whereas the anterior margin of the lower jaw reaches the posterior margin of the upper jaw in *Freemanichthys*, *Leptagonus*, *Agonus* and *Agonopsis*. The jaws are superior in *Bathyagonus nigripinnis* and *Brachyopsinae*.

Discussion. Two jaw characters were selected, and were polarized as follows (Table 9).

Character 7: length of ascending process of premaxillary. The ascending process is long in *Hypsagonus*, but short in other agonids. In the majority of scorpaeniform species examined, the ascending process is shorter than the alveolar

Table 9. Comparison of the jaws in the family Agonidae. D, D1, and D2, derived; P, primitive.

length of Ascending process		mouth		taxa
long	D	terminal	P	Hypsagonus
short	P	terminal	P	Percis
				Bothragonus
				Bathyagonus
				Xenertmus
				Odontopyxis
				Ulcina
				Aspidophoroides
				Anoplagonus
		inferior A	D1	Freemanichthys
				Leptagonus
				Agonus
				Agonopsis
		inferior B	D2	Podothecus
		superior	D	Bathyagonus nigripinnis
				Stellerina
				Chesnonia, Occella
				Tilesina
				Brachyopsis
				Pallasina

process. Only in *Ebosia falcata*, *Oxylebius pictus* and the Congiopodidae, the former is longer than the latter. Accordingly, a long ascending process is considered to be the derived condition.

Character 8: position of mouth. Three mouth positions occur in agonid fishes, terminal, inferior and superior. Generally, the mouth is terminal in the Scorpaeniformes. Platycephalinae, Synanceiidae and Pataecidae have a superior mouth. The mouth is terminal or superior in Sebastinae and Tetraroginae. The inferior mouth is observed in Triglidae. Therefore, it is considered that a terminal mouth is primitive, and both the inferior and superior positions are derived. Furthermore, an even more advanced state, in which the upper jaw is far from the lower one, is observed in *Podothecus*. The *Podothecus*-type jaws are apparently derived from those seen in *Freemanichthys*, *Leptagonus*, *Agonus* and *Agonopsis*.

3. Suspensorium and opercular apparatus (Figs. 63-65, Table 10)

Description. The suspensorium and opercular apparatus are a series of bones

which form the lateral wall of the mouth and gill cavities, and are suspended from the cranium by articulations of the palatine and hyomandibular.

The suspensorium comprises seven elements; hyomandibular, metapterygoid, symplectic, quadrate, entopterygoid, ectopterygoid and palatine.

The opercular apparatus consists of four elements; opercle, preopercle, interopercle and subopercle.

Hyomandibular: The hyomandibular is a thick rectangular bone, which articulates with the cranium at two points of its dorsal margin. It is sutured with the metapterygoid at the ventral part of the anterior margin, and is indirectly attached to the symplectic through a cartilage, at its ventral margin. The hyomandibular is bordered posteriorly by the anterior margin of the preopercle.

Symplectic: The symplectic is a small stick-like bone which contacts with the dorsal margin of the metapterygoid, and is tightly attached to the anterior part of the quadrate.

Quadrate: The quadrate is a fan-like or stick-like bone, which is tightly attached to the thickened, posteroventral margin of the preopercle. It has a facet at its anteroventral portion for articulation with the angular. The quadrate is tightly attached to the palatine anterodorsally in *Stellerina*, *Chesnonia*, *Ocella*, *Tilesina*, *Brachyopsis* and *Pallasina*, but is separated from the palatine in other agonids.

Metapterygoid: The metapterygoid is a thin, rectangular, plate-like bone, attached to the hyomandibular at its anterior margin, and connecting with the symplectic at its ventral margin. It articulates with the quadrate through cartilage. In *Hypsagonus*, *Percis* and *Podothecus*, the metapterygoid is tightly attached to the entopterygoid, but in other agonids it is widely separated from the latter.

Entopterygoid: The entopterygoid is thin, and forms the anteroventral margin of the orbit. It is tightly attached to the palatine at its anterior end and to the ectopterygoid at its ventral margin. In *Ulcina*, the entopterygoid is tiny, but large in other agonids.

Ectopterygoid: The ectopterygoid is a small crescentic bone between the palatine and the quadrate. It is sutured at its anterior tip with the posterior portion of the palatine, and is tightly attached to the entopterygoid on its dorsal margin and to the quadrate posteriorly. In *Tilesina*, the ectopterygoid is a small, scale-like bone on the medial aspect of the palatine-entopterygoid attachment region, and is surrounded by the palatine, entopterygoid and quadrate (Fig. 65). It is absent altogether in *Ocella*, *Brachyopsis* and *Pallasina*.

Palatine: The palatine is a stout, stick-like bone, which is situated at the anteriormost portion of the suspensorium. It is sutured with the ectopterygoid or quadrate posteriorly, and attached to the entopterygoid posterodorsally. The palatine has a prong which lies on the dorsal base of the maxillary head. In *Hypsagonus*, the bone is pistol-like, but in other agonids is elongate and stick-like, and is slightly ventrally recurved. The palatine teeth are conical in most agonid fishes, but are absent in *Percis*, *Leptagonus*, *Podothecus*, and *Brachyopsis*, and may be either present or absent in *Hypsagonus quadricornis*, *H. jordani* and *H. proboscidalis*.

Preopercle: The preopercle is the largest bone of the opercular apparatus, and is crescentic in shape. The anterior margin is tightly attached to the hyoman-

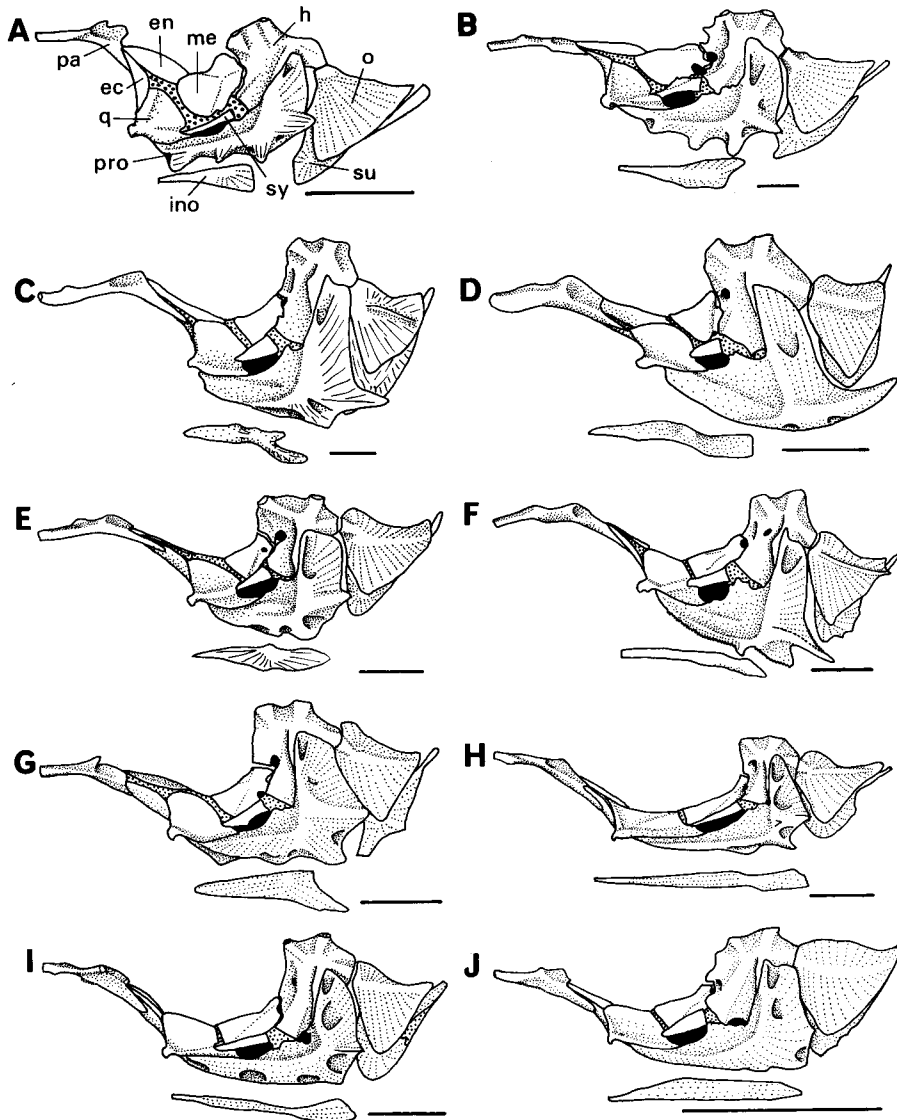

Fig. 63. Lateral aspect of the suspensorium and opercular bones in the family Agonidae.

A, *Hypsagonus quadricornis*; B, *Percis japonicus*; C, *Podothecus acipenserinus*; D, *Agonus cataphractus*; E, *Leptagonus decagonus*; F, *Freemanichthys thompsoni*; G, *Agonopsis vulsa*; H, *Bathyagonus nigripinnis*; I, *Xenertmus latifrons*; J, *Odontopyxis trispinosa*. ec, ectopterygoid; en, entopterygoid; h, hyomandibular; ino, interopercle; me, metapterygoid; o, opercle; pa, palatine; pro, preopercle; q, quadrate; su, subopercle; sy, symplectic. Scale bars indicate 5 mm.

dibular dorsally and to the quadrate ventrally. Posteriorly the preopercle contacts with the opercle and subopercle, and ventromedially with the interopercle. Spines on the posterior and ventral margins of the preopercle are variable in number and shape. *Hypsagonus jordani* possesses a well developed spine, which has a serrated margin. Two spines occur in *Leptagonus* and *Podothecus*, three in *Bathyagonus*, *Stellerina*, *Chesnomia*, *Occella*, *Brachyopsis* and *Pallasina*, and four in *Hypsagonus*, *Percis* and *Tilesina*.

Opercle: The opercle is a large triangular bone next to the preopercle in the opercular apparatus. It articulates with the hyomandibular at its anterior tip, and is tightly attached to the subopercle at its lower portion.

Subopercle: The subopercle is a thin, fishhook-like bone attached to the opercle. It has a sharp ventral edge in *Hypsagonus*, *Percis* and *Podothecus*.

Interopercle: The interopercle is a thin, elongate plate, which tapers anteriorly.

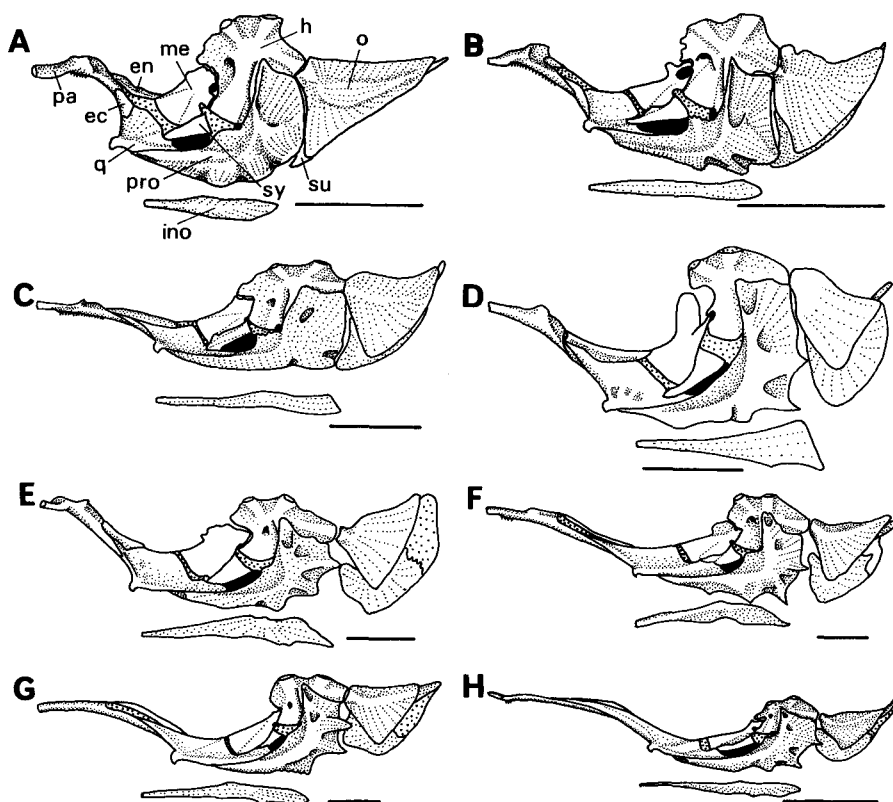

Fig. 64. Lateral aspect of the suspensorium and opercular bones in the family Agonidae. A, *Bothragonus swani*; B, *Ulcina olriki*; C, *Aspidophoroides monopterygius*; D, *Stellerina xyosterna*; E, *Occella dodecaedron*; F, *Tilesina gibbosa*; G, *Brachyopsis segaliensis*; H, *Pallasina barbata*. Scale bars indicate 5 mm. (abbreviations, see Fig 63).

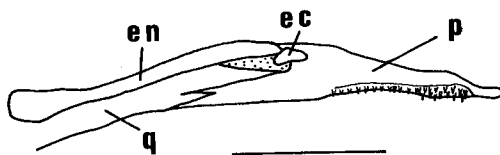

Fig. 65. Medial aspect of the anterior part of the suspensorium in *Tilesina gibbosa*. ec, ectopterygoid; en, entopterygoid; p, palatine; q, quadrate. A scale bar indicate 5 mm.

Table 10. Comparison of the suspensorium and opercular apparatus in the family Agonidae. D, D1, D2, derived; P, primitive.

Attachment between entopterygoid and metapterygoid		Attachment between entopterygoid and quadrate		Ectopterygoid		taxa
present	P	present	P	large	P	Hypsagonus Percis Bothragonus swani Stellerina
absent	D	absent	D	small	D1	Freemanichthys Leptagonus Podothecus Agonus Agonopsis Bothragonus occidentalis Bathyagonus Xenertmus Odontopyxis Aspidophoroides Anoplagonus Chesnonia
						absent
		present	P	absent	D2	Tilesina Occella Brachyopsis Pallasina

It is connected ligamentously with the retroarticular anteriorly and the subopercle posteriorly, and is attached to the preopercle on its dorsal margin.

Discussion. Among the suspensorium and opercular apparatus of the agonids examined, the following interspecific variations were recognized: character 9, condition of attachment between entopterygoid and metapterygoid; character 10, condition of attachment between entopterygoid and quadrate; character 11, condition of ectopterygoid. The polarities of these character states were determined as follows (Table 10).

Character 9: condition of attachment between entopterygoid and metapterygoid. An attachment between the entopterygoid and metapterygoid is present in *Hypsagonus*, *Percis*, *Stellerina* and *Bothragonus swani*, but absent in other agonids. The presence of this attachment has been widely observed in the cottoid fishes, Hexagrammidae, Anoplopomatidae, Scorpaenidae (Matsubara, 1943), and Platycephalidae (Matsubara and Ochiai, 1955), and is therefore considered to represent the primitive condition.

Character 10: condition of attachment between entopterygoid and quadrate. An attachment between the entopterygoid and quadrate is present in almost all agonid fishes, being absent only in *Ulcina*. Its presence has been widely observed in scorpaeniform fishes (Allis, 1909; Gregory, 1933; Matsubara, 1943; Matsubara and Ochiai, 1955; Yabe, 1985; Kido, 1988). Accordingly, the presence of this attachment in agonids is judged to be the primitive state.

Character 11: condition of ectopterygoid. The ectopterygoid is large in the majority of agonid fishes, but small in *Tilesina*, and absent in *Ocella*, *Brachyopsis* and *Pallasina*. A large ectopterygoid is widely known in the order Scorpaeniformes. Kido (1988) reported it to be reduced or absent in Liparididae. It is therefore considered that the presence of a large ectopterygoid is the primitive state.

4. Hyoid apparatus (Figs. 66-69, Table 11)

Description. The hyoid apparatus is located between the opercular apparatus and the branchial arch, and consists of the hypohyal, ceratohyal, epihyal, interhyal, urohyal, basihyal and branchiostegal rays. The basihyal is described later in the section dealing with the branchial apparatus.

Hypohyal: The hypohyal is knob-like, and present at the anteriormost part of the hyoid apparatus. It is connected through cartilage with its opposite number, and is tightly attached to the ceratohyal. In this bone, there are two elements filled with cartilage.

Ceratohyal: The ceratohyal is a large, stout bone, which is connected to the hypohyal anteriorly, and the epihyal posteriorly. The anterior branchiostegal rays are attached to its ventral margin.

Epihyal: The epihyal is stout and triangular, being pointed posteriorly. It is connected to the ceratohyal at its anterior margin, and articulates with the interhyal posterodorsally. The ventral margin supports two branchiostegal rays.

Interhyal: The interhyal is small and stick-like, articulating with cartilage surrounded by the symplectic, metapterygoid, hyomadibular and preopercle. It is longer than the epihyal in *Hypsagonus*, but shorter in other agonid fishes.

Branchiostegal rays: The branchiostegal rays are curved, rod-like bones, con-

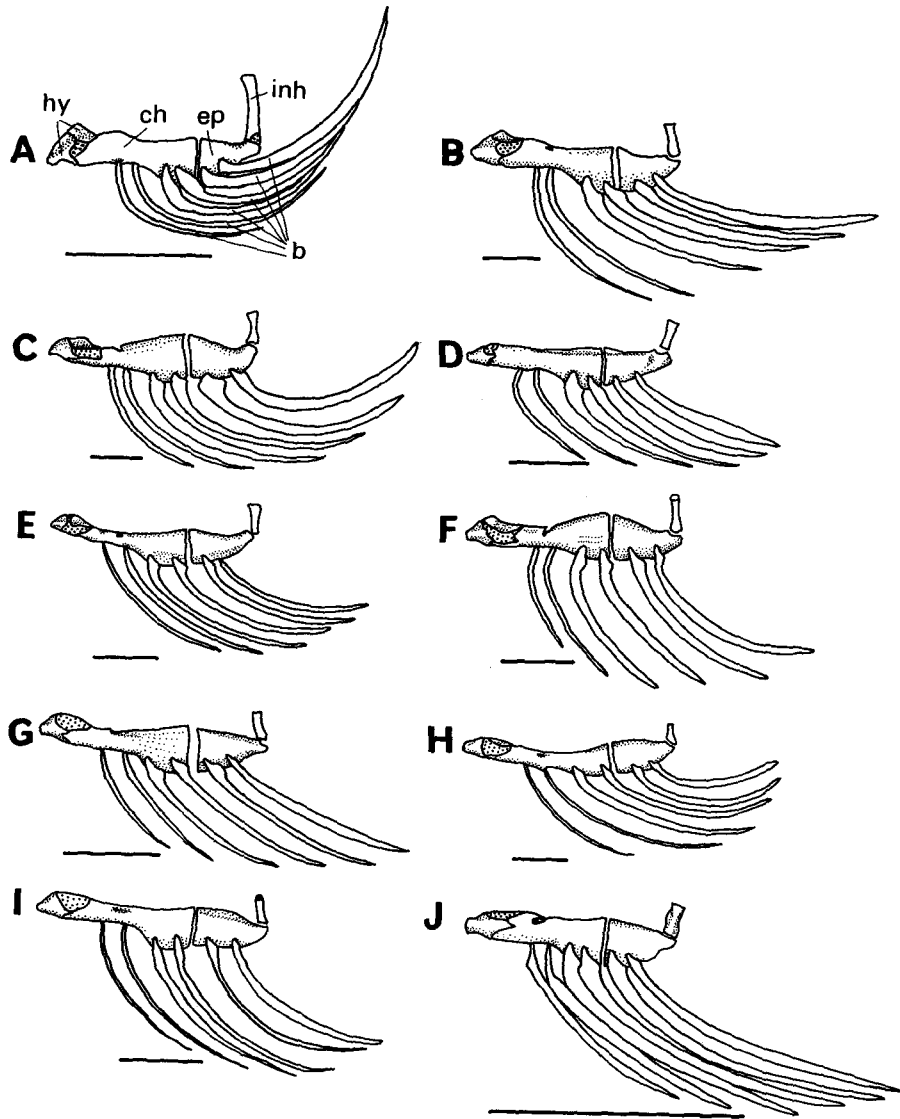

Fig. 66. Lateral aspect of the hyoid arch in the family Agonidae. A, *Hypsagonus quadricornis*; B, *Percis japonicus*; C, *Podothecus acipenserinus*; D, *Agonus cataphractus*; E, *Leptagonus decagonus*; F, *Freemanichthys thompsoni*; G, *Agonopsis vulsa*; H, *Bathyagonus nigripinnis*; I, *Xenertmus latifrons*; J, *Odontopyxis trispinosa*. b, branchiostegal rays; ch, ceratohyal; ep, epihyal; hy, hypohyal; inh, interhyal. Scale bars indicate 5 mm.

ned with the ventral margins of the ceratohyal and the epihyal. Five branchiostegals occur in *Pallasina*, and six in all other agonid fishes. The two posterior rays are attached to the ventrolateral margin of the epihyal, whereas the three or four anterior rays are attached to the ventral margin of the ceratohyal.

Urohyal: The urohyal is a flat, median bone, slightly posteroventral to the connection of the right and left hypohyals. Anteriorly it is connected ligamentously with the ventral surface of the hypohyal, and supports the sternohyoideus. In lateral view, the urohyal is square in shape, with the ventrolateral keel absent or rudimentary in *Hypsagonus*, *Percis*, *Leptagonus*, *Podothecus*, *Stellerina*, *Chesnonia* and *Ocella*, and oblong and plate-like in *Tilesina*, *Brachyopsis* and *Pallasina*. It is triangular and wing-like, with a ventrolateral keel, in *Bathyagonus*, *Xenertmus*, *Odontopyxis*, *Ulcina*, *Aspidophoroides* and *Anoplagonus*. In dorsal view, the urohyal is needle-like, and does not have a depression for articulation with the basihyal in

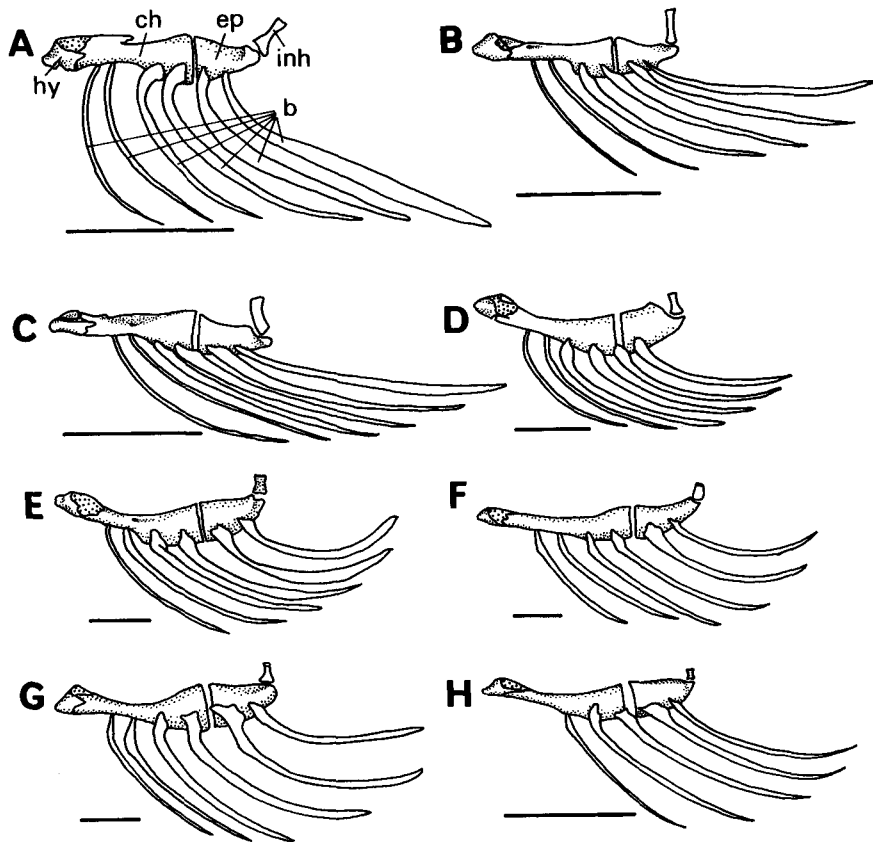

Fig. 67. Lateral aspect of the hyoid arch in the family Agonidae. A, *Bothragonus swani*; B, *Ulcina olriki*; C, *Aspidophoroides monopterygius*; D, *stellerina xyosterna*; E, *Ocella dodecaedron*; F, *Tilesina gibbosa*; G, *Brachyopsis segaliensis*; H, *Pallasina barbata*. Scale bars indicate 5 mm. (abbreviations, see Fig. 66).

Hypsagonus, *Percis*, and *Brachyopsinae*. A dorsal depression for such articulation is located anteriorly in *Leptagonus* and *Anoplagoninae*, and posteriorly in *Freemanichthys*, *Podothecus* and *Agonus*.

Discussion. Concerning the hyoid apparatus, the following interspecific variations were observed: character 12, length of interhyal; character 13, number of branchiostegal rays; character 14, condition of ventral keel of urohyal. For each

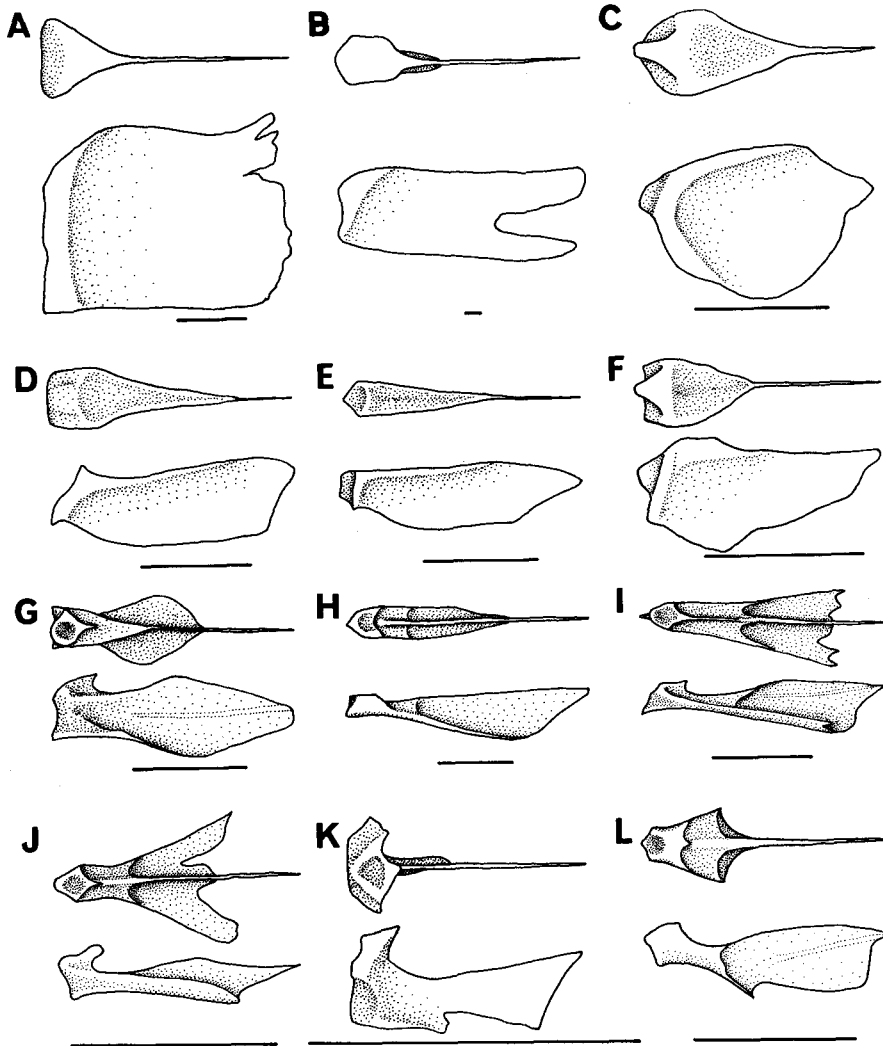

Fig. 68. Dorsal and lateral aspects of the urohyal in the family Agonidae. A, *Hypsagonus quadricornis*; B, *Percis japonicus*; C, *Podothecus acipenserinus*; D, *Agonus cataphractus*; E, *Leptagonus decagonus*; F, *Freemanichthys thompsoni*; G, *Agonopsis vulsa*; H, *Bathyagonus nigripinnis*; I, *Xenertmus latifrons*; J, *Odontopyxis trispinosa*; K, *Bothragonus swani*; L, *Ulcina olriki*. Scale bars indicate 3 mm.

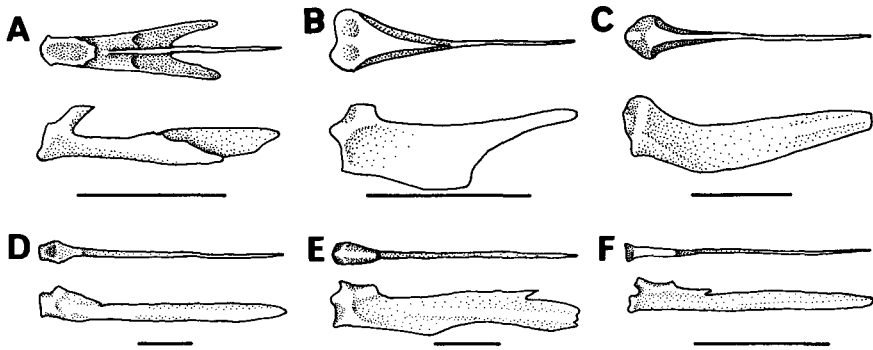

Fig. 69. Dorsal and lateral aspects of the urohyal in the family Agonidae. A, *Aspidophoroides monopterygius*; B, *Stellerina xyosterna*; C, *Ocella dodecaedron*; D, *Tilesina gibbosa*; E, *Brachyopsis segaliensis*; F, *Pallasina barbata*. Scale bars indicate 3 mm.

Table 11. Comparison of the hyoid apparatus in the family Agonidae. D, derived; P, primitive.

Interhyal		Branchiostegal ray		Ventral keel of urohyal		taxa
long	D	six	P	absent	P	Hypsagonus
short	P					present
		five	D	absent	P	

character, the character states were polarized as follows (Table 11).

Character 12: length of interhyal. The interhyal is long in *Hypsagonus*, but short in other agonids. A short interhyal is widely distributed in scorpaeniform fishes (Matsubara, 1943; McAllister, 1968; Yabe, 1985), whereas a long interhyal has been recorded infrequently in *Eumicrotremus pacificus* of Liparididae (Kido, 1988), and *Ebosia falcata*. Therefore, it is regarded that a short interhyal represents the primitive state.

Character 13: number of branchiostegal rays. Branchiostegal rays are six in the majority of agonid fishes, and five in *Pallasina*. Generally in teleostean fishes, these rays reduce in number from lower teleosts to upper ones (Gosline, 1967; McAllister, 1968). These rays are seven in Synanceiidae, Platycephalidae, Peristediinae and Psychrolutidae, six or seven in Scorpaenidae, Triglinae and Hexagrammidae, and six in Anoplopomatidae, Rhamphocottidae, Ereuniidae, Hemitripterae, Cottidae, and Cyclopteridae (McAllister, 1968; Yabe, 1985). It is clear that the five branchiostegal rays in *Pallasina* are a derived state.

Character 14: condition of ventral keel of urohyal. A ventral keel on the urohyal was observed in *Agonopsis*, *Bathyagonus*, *Xenertmus*, *Odontopyxis*, *Ulcina*, *Aspidophoroides* and *Anoplagonus*. Such a keel is absent in other agonids, and also in Hemitripterae, Cottidae, Hexagrammidae and Zaniolepididae (Watanabe, 1958; Kusaka, 1974). Accordingly, the absence of a ventral keel is considered to be the primitive condition.

5. Branchial apparatus (Figs. 70-71, Table 12)

Description. The branchial apparatus consists of one to three median basibranchials, three hypobranchials, four ceratobranchials, four epibranchials, one upper pharyngeal and one lower pharyngeal. The basihyal is described below, relative to elements of the oral floor.

Basibranchial: The basibranchials are a series of small stick-like bones on the mid-line of the oral floor. Cartilaginous elements are associated with these bones. Generally, three basibranchials occur in agonid fishes. However, the first basibranchial is absent in *Tilesina*, *Brachyopsis* and *Pallasina*, the third in *Anoplagonus inermis*, and the second and third in *A. occidentalis*.

Hypobranchial: The hypobranchials are three small bones, articulating with the basibranchial anteriorly, and the ceratobranchial posteriorly. The first and second hypobranchials are plate-like, and the third fan-shaped.

Ceratobranchial: The ceratobranchials are short, rod-like bones in four pairs. The first three articulate between the hypobranchial and the epibranchial, whereas the fourth is connected anteriorly with cartilage posterior to the third basibranchial.

Epibranchial: The epibranchials are stick-like bones, upper end of which support the upper pharyngeals, while the lower end articulates with the ceratobranchials.

Upper pharyngeal: The upper pharyngeal is a round bone, bearing a tooth plate, and is placed at the oral roof. In agonid fishes, the third upper pharyngeal is present, whereas the first, second and fourth ones are absent.

Lower pharyngeal: The lower pharyngeal is a triangular bone, bearing a tooth plate. It is positioned parallel to the fourth ceratobranchial.

Basihyal: In the Scorpaeniformes, the basihyal is generally a single, median bone on the oral floor, anterior to the first basibranchial. It is rudimentary in *Freemanichthys* and *Leptagonus frenatus*, and absent from other agonids.

Discussion. The following interspecific variations were recognized in the agonid branchial apparatus: character 15, number of basibranchials; character 16, condition of basihyal. The polarities of these characters were determined as follows

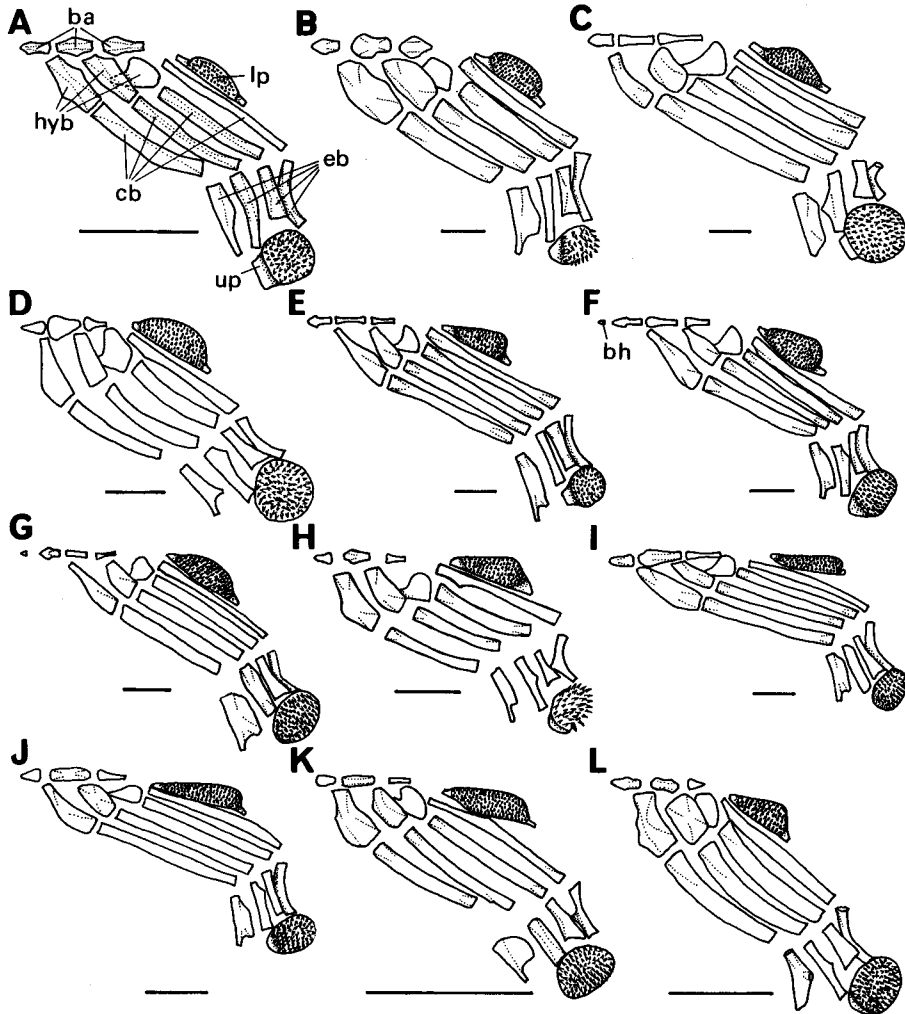

Fig. 70. Dorsal aspect of the branchial arch in the family Agonidae. A, *Hypsagonus quadricornis*; B, *Percis japonicus*; C, *Podothecus acipenserinus*; D, *Agonus cataphractus*; E, *Leptagonus decagonus*; F, *L. frenatus*; G, *Freemanichthys thompsoni*; H, *Agonopsis vulsa*; I, *Bathyagonus nigripinnis*; J, *Xenertmus latifrons*; K, *Odontopyxis trispinosa*; L, *Bothragonus swani*. ba, basibranchial; bh, basihyal; cb, ceratobranchial; eb, epibranchial; hyb, hypobranchial; lp, lower pharyngeal; up, upper pharyngeal. Scale bars indicate 3 mm.

(Table 12).

Character 15: number of basibranchials. The basibranchials number one in *Anoplagonus occidentalis*, two in *Anoplagonus inermis*, *Tilesina*, *Brachyopsis* and *Pallasina*, and three in other agonids. They number three in the majority of Scorpaeniformes (Matsubara, 1943; Matsubara and Ochiai, 1955; Watanabe, 1958; Quast, 1965; Ueno, 1970; Yabe, 1985), although Kido (1988) found two to four in Liparididae. Furthermore, teleostean fishes have generally three basibranchials (Nelson, 1969). Accordingly, three basibranchials are considered to be the primitive state. And a single basibranchial remaining, is considered as more derived than two remaining.

Character 16: condition of basihyal. The basihyal is rudimentary in *Freemanichthys* and *Leptagonus frenatus*, and absent in other agonids. Yabe (1985) depicted the reduction of the basihyal in cottoid fishes. It is a tiny bone in *Jordania* and *Careproctus ostentum*, cartilagenous in Rhamphocottidae, and absent in the majority of cottoid fishes including Liparididae (Yabe, 1985; Kido, 1988). In Scorpaenoidei, Platycephaloidei and Hexagrammoidei, the basihyal is well developed. Therefore, the presence of a basihyal is regarded as the primitive condition in agonids.

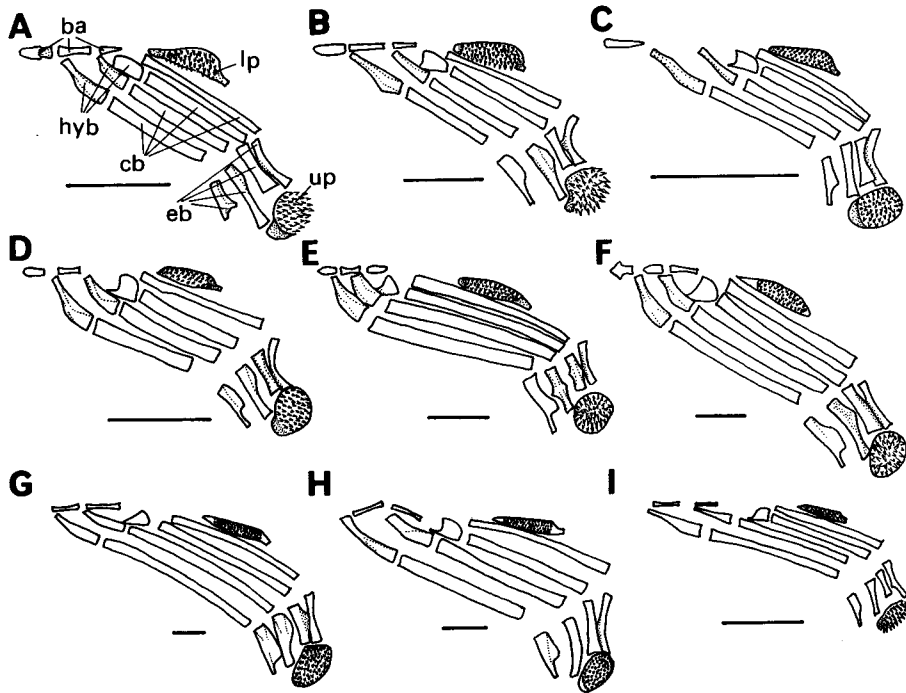

Fig. 71. Dorsal aspect of the branchial arch in the family Agonidae. A, *Ulcina otriki*; B, *Aspidophoroides monopterygius*; C, *Anoplagonus occidentalis*; D, *A. inermis*; E, *Stellerina xyosterna*; F, *Ocella dodecaedron*; G, *Tilesina gibbosa*; H, *Brachyopsis segaliensis*; I, *Pallasina barbata*. Scale bars indicate 3 mm. (abbreviations, see Fig. 70).

Table 12. Comparison of the branchial apparatus in the family Agonidae. D, derived; P, primitive.

Second basibranchial		Third basibranchial		First basibranchial		Basihyal		taxa
present	P	present	P	present	P	present	P	Freemanichthys Leptagonus frenatus
						absent	D	Hypsagonus Percis Leptagonus decagonus L. leptorhynchus Podothecus Agonus Agonopsis Bothragonus Bathyagonus Xenertmus Odontopyxis Ulcina Aspidophoroides Chesnonia Stellerina Ocella
				absent	D			Tilesina Brachyopsis Pallasina
		absent	D	present	P			Anoplagonus inermis
absent	D							A. occidentalis

6. Cranium (Figs. 72-80; Table 13-14)

Description. The agonid cranium is composed of a series of bones, including the nasal, prevomer, ethmoid, prefrontal, frontal, parasphenoid, pterosphenoid, sphenotic, prootic, parietal, pterotic, epiotic, intercalar, exoccipital, supraoccipital, and basioccipital. A basisphenoid is absent in agonids.

Nasal: The nasal is a small, square or arched bone, attached to the dorsal surface of the ethmoid. A sensory canal runs through its center. The right and left nasals are separated from each other and lack an anteromedial projection in *Hypsagonus mozinoi*, *Stellerina*, *Chesnonia*, *Ocella*, *Tilesina*, *Brachyopsis* and *Pallasina*. In *Hypsagonus quadricornis*, *H. corniger* and *H. proboscidalis*, the nasal has an anteromedial projection, and is connected to its opposite number by a ligament. Direct attachment to each other occurs anteriorly in *Hypsagonus jordani*, *Percis*,

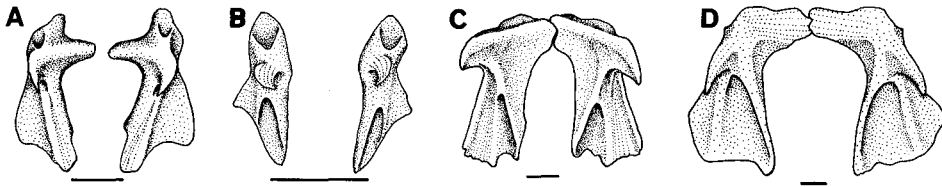

Fig. 72. Dorsal aspect of the nasal bones in the family Agonidae. A, *Hypsagonus quadricornis*; B, *H. mozinoi*; C, *H. jordani*; D, *Percis japonicus*. Scale bars indicate 1 mm.

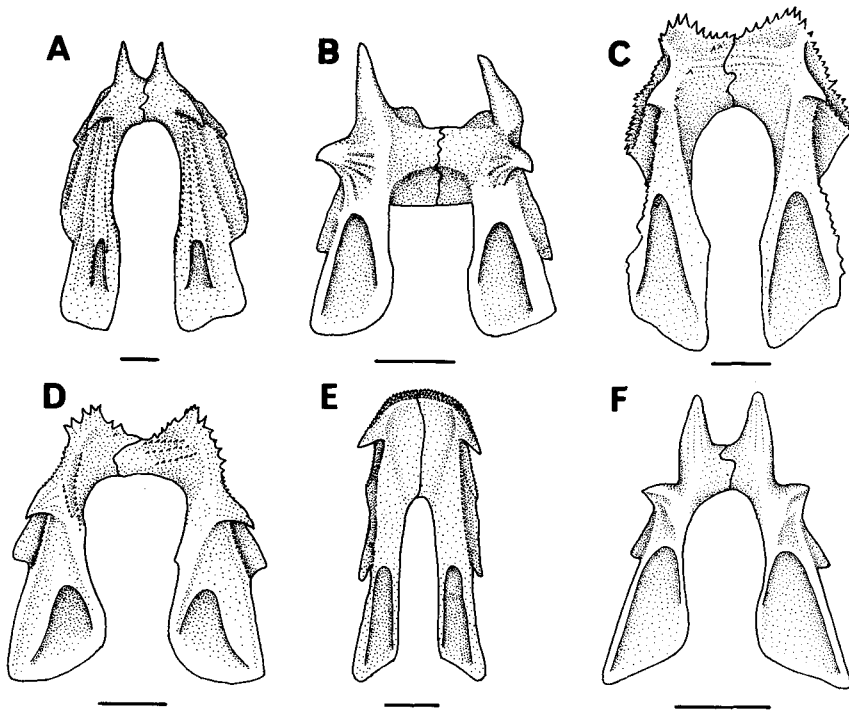

Fig. 73. Dorsal aspect of the nasal bones in the family Agonidae. A, *Podothecus acipenserinus*; B, *Agonus cataphractus*; C, *Freemanichthys thompsoni*; D, *Leptagonus decagonus*; E, *L. leptorhynchus*; F, *Agonopsis vulsa*. Scale bars indicate 2 mm.

Leptagonus and *Podothecus*. In *Freemanichthys*, *Agonus* and *Agonopsis*, the nasals are directly attached to each other with a rostral plate on their anteroventral surface. The rostral plate is positioned at the anterior end of the attached nasals in *Bothragonus*, *Bathyagonus*, *Xenertmus*, *Odontopyxis* and *Aspidophorooides*. In *Anoplagonus*, the nasals are separated from each other, and articulate anteriorly with a rostral plate.

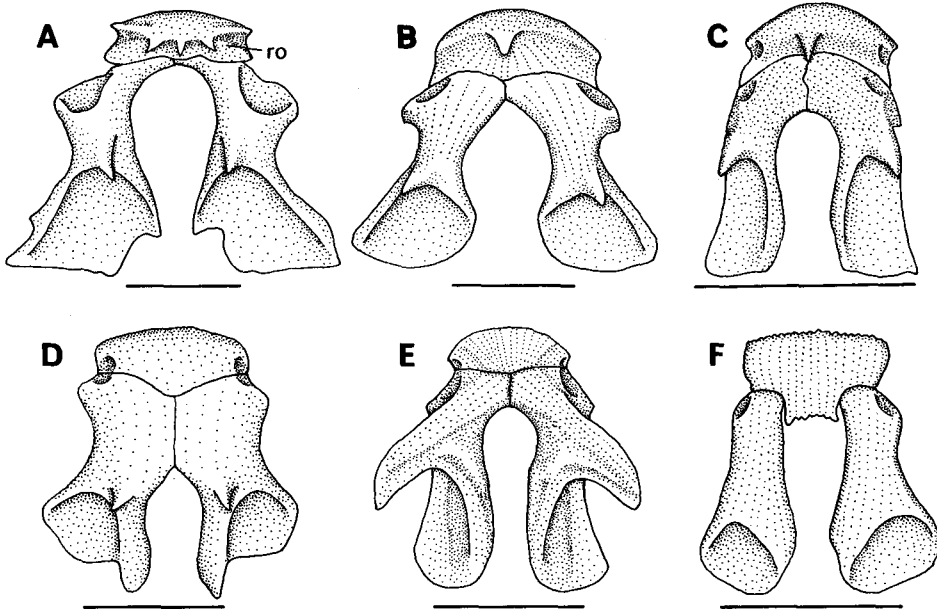

Fig. 74. Dorsal aspect of the nasal bones in the family Agonidae. A, *Bathyagonus nigripinnis*; B, *Xenertmus latifrons*; C, *Odontopyxis trispinosa*; D, *Bothragonus swani*; E, *Aspidophoroides monopterygius*; F, *Anoplagonus occidentalis*. ro, rostral plate. Scale bars indicate 2 mm.

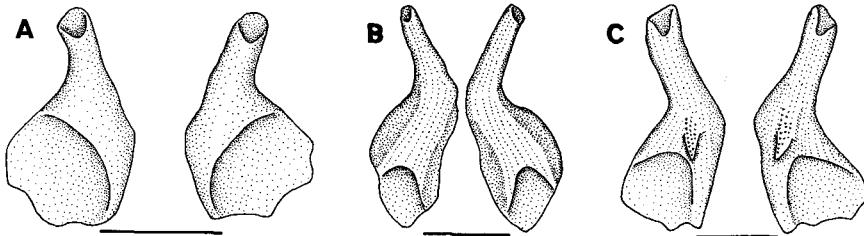

Fig. 75. Dorsal aspect of the nasal bones in the family Agonidae. A, *Ocella dodecaedron*; B, *Brachyopsis segaliensis*; C, *Tilesina gibbosa*. Scale bars indicate 2 mm.

Prevomer: The prevomer is a flattened, median bone, lying anteriormost in the cranium, and connected to the parasphenoid posteriorly, and the prefrontal postero-dorsally. In ventral view, it is wedge-like. The anterior portion of the prevomer is attached dorsolaterally to the ethmoid in *Odontopyxis* and *Brachyopsinae*. In other agonid fishes, it is separated from the ethmoid by the ethmoidal cartilage.

Ethmoid: The ethmoid is a quadrangular, median bone with a middorsal ridge, and is surrounded by the prevomer, frontal and prefrontal. Posterodorsal spines on the ethmoid are one in *Freemanichthys*, two in *Leptagonus frenatus*, *L. leptorhynchus*,

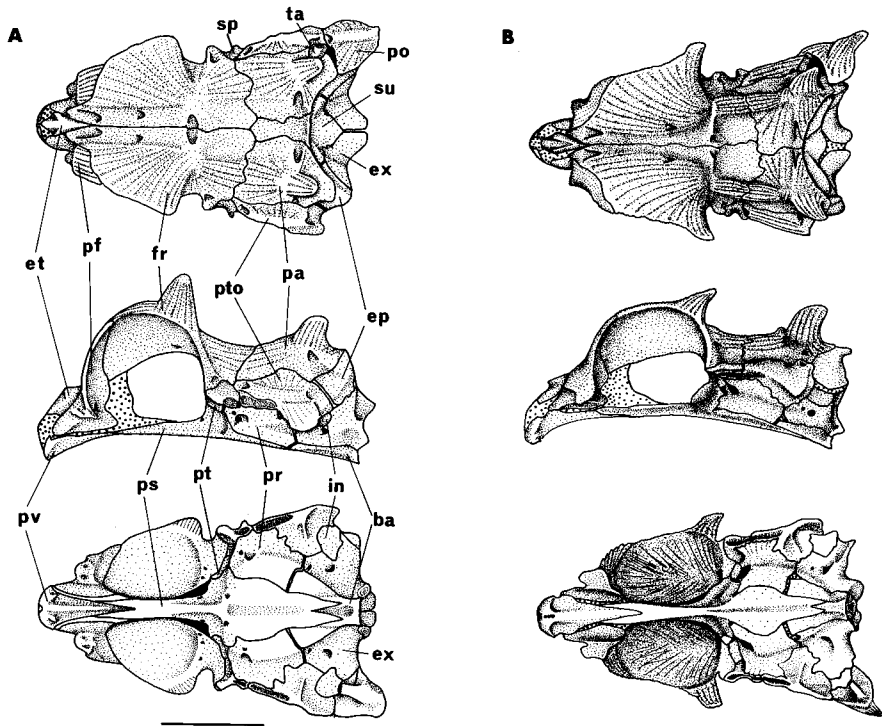

Fig. 76. Dorsal, lateral and ventral aspects of the cranium. A, *Hypsagonus quadricornis*; B, *H. jordani*. ba, basioccipital; ep, epiotic; et, ethmoid; ex, exoccipital; fr, frontal; in, intercalar; pa, parietal; pf, prefrontal; po, posttemporal; pr, prootic; ps, parasphenoid; pt, pterotic; pto, pterosphenoid; pv, prevomer; sp, sphenotic; su, supraoccipital; ta, tabular bone. Scales indicate 5 mm.

Podothecus and *Agonopsis vulsa*, and are absent in other agonid fishes. The anterior process on the ethmoid is enlarged in *Freemanichthys*, *Leptagonus*, *Podothecus*, *Agonus*, and *Agonopsis*.

Prefrontal: The prefrontal is an enlarged bone, triangular in dorsal view, which is attached to the prevomer anteroventrally, the parasphenoid posteroventrally, and the ethmoid and frontal mediolaterally. An articular facet for the lachryocranial articulation of the prefrontal is present anteriorly in *Tilesina*, *Brachyopsis* and *Pallasina*, and posteriorly in other agonids.

Frontal: The frontal is the largest paired bone of the cranium, and is attached to its opposite number in the mid-line. It is connected anteriorly to the ethmoid and prefrontal, posteriorly to the supraoccipital, parietal and pterotic, and posteroventrally to the pterosphenoid and sphenotic. The ventral margin of the frontal is recurved, forming the upper margin of the orbit. The dorsal margin of the orbit is convex in *Hypsagonus* and *Percis*, and concave in other agonids. An attachment between the frontal and the parasphenoid is present in *Hypsagonus proboscidalis*, *H. jordani*, *Agonopsis sterletus*, *A. chilensis*, *Aspidophoroides* and *Anoplagonus*, but

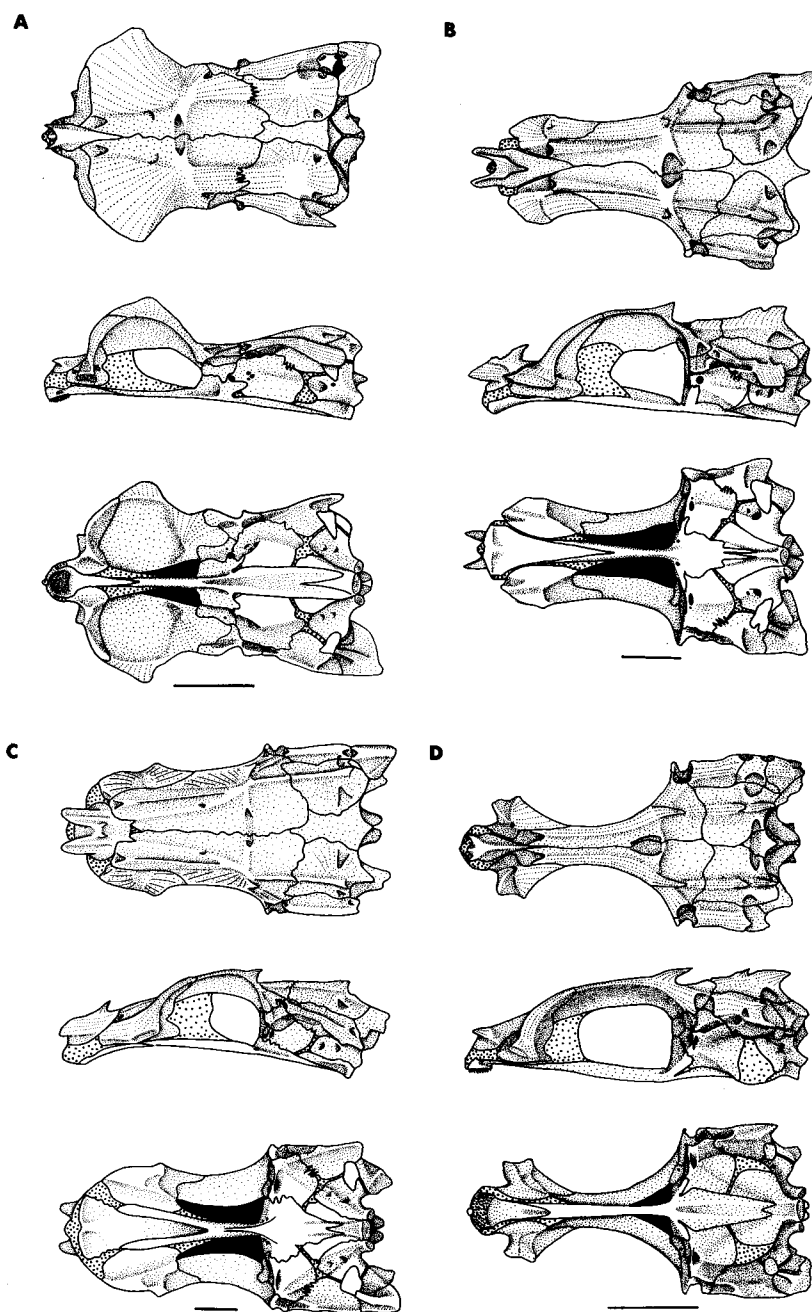

Fig. 77. Dorsal, lateral and ventral aspects of the cranium. A, *Percis japonicus*; B, *Freemanichthys thompsonsi*; C, *Podothecus acipenserinus*; D, *Xenertmus latifrons*. For abbreviations, see Fig. 76. Scales indicate 5 mm.

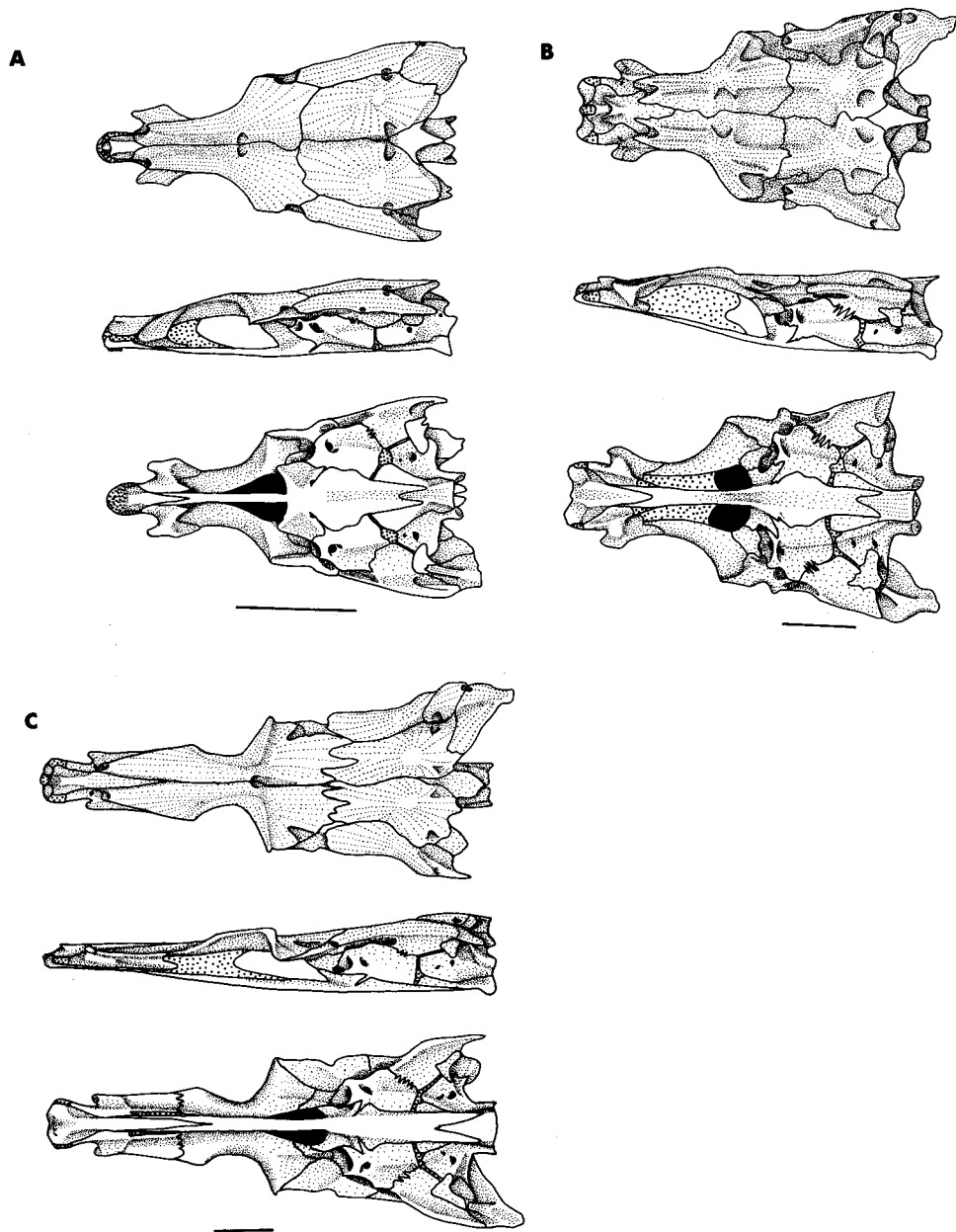

Fig. 78. Dorsal, lateral and ventral aspects of the cranium. *A*, *Anoplagonus inermis*; *B*, *Ocella dodcaedron*; *C*, *Brachyopsis segaliensis*. For abbreviations, see Fig. 76. Scales indicate 5 mm.

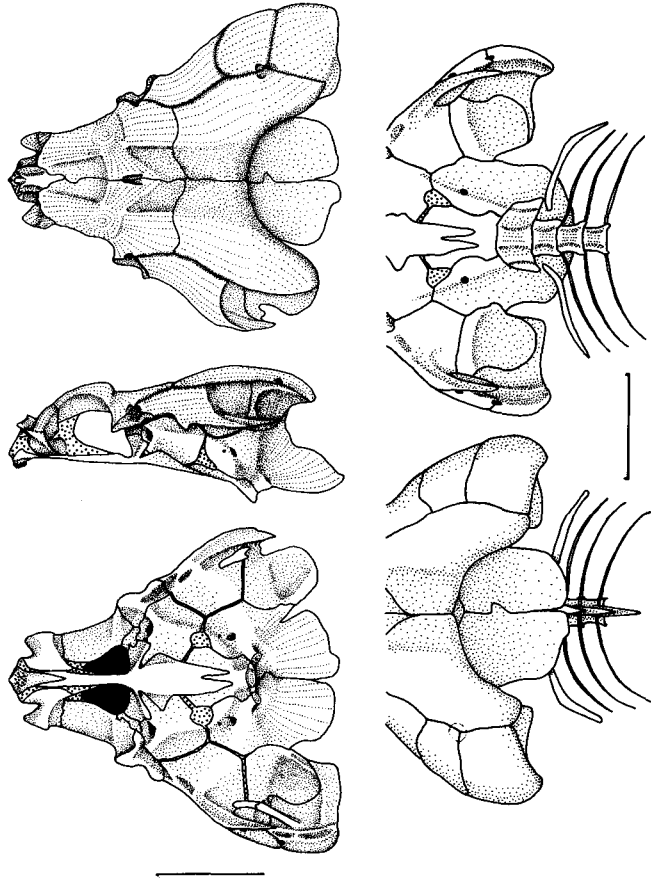

Fig. 79. Dorsal, lateral and ventral aspects of the cranium, and ventral and dorsal aspects of the postcranial region in *Bothragonus swani*. For abbreviations, see Fig. 76. Scales indicates 5 mm.

absent in other agonids (Fig. 80).

Parietal: The parietal is a squarish bone on the posterodorsal portion of the cranium. The anterior margin is tightly attached to the frontal, and the lateral margin contacts the pterotic. The posterior part of the parietal is connected to the epiotic and supraoccipital.

Parasphenoid: The parasphenoid is an elongate, median bone, connected with the prevomer and prefrontal anteriorly, and the prootic and basioccipital posteriorly. It has an ascending process at the posteroventral margin of the orbit.

Pterosphenoid: The pterosphenoid is a small, squarish bone surrounded by the frontal, sphenotic, prootic and parasphenoid.

Sphenotic: The sphenotic is a small bone supporting the fifth infraorbital, and is surrounded by the frontal, parietal, pterotic, prootic and pterosphenoid.

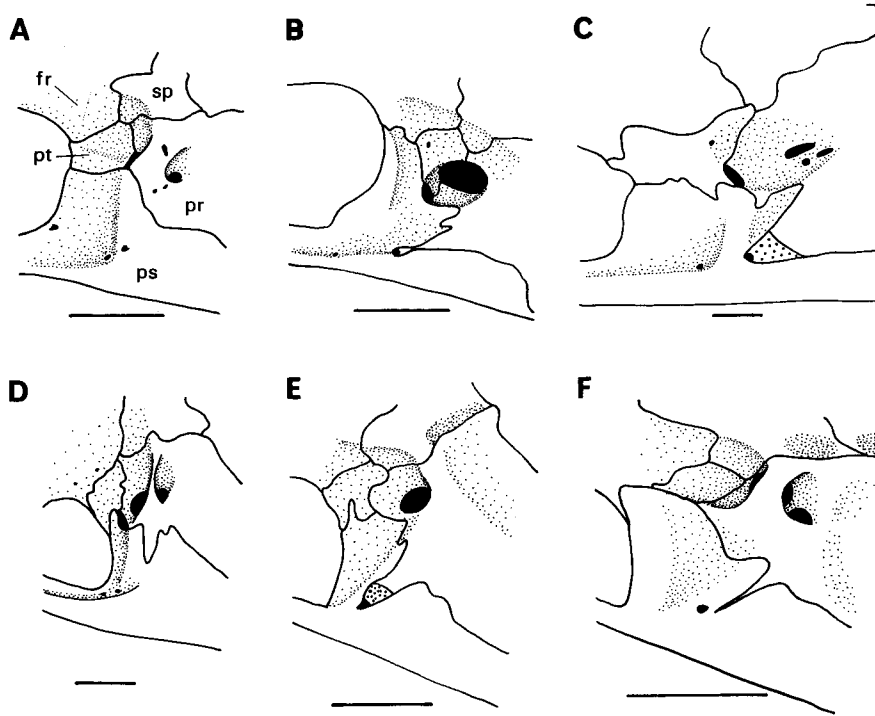

Fig. 80. Anterolateral aspect of the postorbital region in the family Agonidae. A, *Hypsagonus quadricornis*; B, *H. jordani*; C, *Percis japonicus*; D, *Podothecus acipenserinus*; E, *Bothragonus swani*; F, *Anoplagonus inermis*. fr, frontal; pr, prootic; ps, parasphenoid; pt, pterosphenoid; sp, sphenotic. Scale bars indicate 2 mm.

Prootic: The prootic is a large bone, forming the posterolateral surface of the cranium. It is surrounded by the pterosphenoid, parasphenoid, sphenotic, pterotic, exoccipital and basioccipital. Its posterior margin is indirectly attached to the exoccipital and basioccipital, through cartilage or the auditory fenestra. In the anterior portion of the prootic, a vertical bridge is absent on the trigeminal facialis chamber in *Hypsagonus jordani*, *Percis japonicus*, *Agonus* and *Bothragonus swani*, but present in other agonid fishes (Fig. 80).

Pterotic: The pterotic is located on the dorsolateral portion of the posterior cranium, being surrounded by the sphenotic anteriorly, the parietal dorsally, the prootic and exoccipital ventrally, and the epiotic and intercalar posteriorly.

Epiotic: The epiotic, on the posterodorsal portion of the cranium, is surrounded by the parietal, supraoccipital, exoccipital, pterotic, and intercalar, and is connected to the posttemporal.

Intercalar: The intercalar is a tiny bone, found at the junction of the pterotic, epiotic and exoccipital bones.

Exoccipital: The exoccipital, at the posterior portion of the cranium, is sur-

Table 13. Comparison of the nasal bones in the family Agonidae. D, D1, D2, derived ; P, primitive.

Attachment between nasals		Anterior free nasal margin		Forward projection of nasal		Rostral plate		Spine on rostral plate		taxa
absent	P	smooth	P	absent	P	absent	P	absent	P	Hypsagonus mozinoi Stellerina Chesnonia Occella Tilesina Brachyopsis Pallasina
present	D1	serrated	D1	present	D	present	D	one	D1	Hypsagonus Percis
		with a spine	D2							Leptagonus Podothecus
			serrated	D1	Agonus Agonopsis					
		smooth	P	absent	P					three
		secondary absent	D2							

Table 14. Comparison of the cranium in the family Agonidae. AB, attachment between prevomer and ethmoid; AF, articular facet of prefrontal; AP, anterior process of ethmoid; BT, bridge of trigeminal facialis chamber; DM, dorsal margin of orbit; EE, exposed exoccipital; ES, ethmoidal spine; RB, relation between frontal and parasphenoid. D, derived; P, primitive.

AB		ES		AP		AF		RB		DM		EE		BT		taxa
absent	P	absent	P	small	P	posterior	P	separate	P	convex	D	absent	D	absent	D	<i>Percis japonicus</i>
														present	P	<i>Hypasagonus mozinoi</i> <i>H. corniger</i> <i>H. quadricornis</i> <i>P. matsuii</i> <i>H. proboscidalis</i>
		two	D1	large	D			separate	P	concave	P			absent	D	<i>H. jodani</i>
														present	P	<i>Leptagonus frenatus</i> <i>L. leptorhynchus</i> <i>Podothecus</i> <i>Freemanichthys</i> <i>L. decagonus</i>
		one	D2	small	P			attach	D	absent	D			absent	D	<i>Agonus</i>
														present	P	<i>Bathyagonus</i> <i>Xenertmus</i> <i>Ulcina</i> <i>Aspidophoroides</i> <i>Anoplagonus</i>
		absent	P	large	D			separate	P	present	D			absent	D	<i>Agonopsis sterletus</i> <i>A. chiloensis</i> <i>A. vulsa</i> <i>Odontopyxis</i>
														present	P	<i>Bothragonus swani</i> <i>B. occidentalis</i>
		present	D	absent	P			small	P	absent	P			absent	P	<i>Stellerina</i> <i>Chesonia</i> <i>Occella</i> <i>Tilesina</i> <i>Brachyopsis</i> <i>Pallasina</i>
		absent	P	two	D1			small	P					absent	P	
present	D	absent	P			small	P			absent	P					
						anterior	D									

rounded by the prootic, basioccipital, pterotic, intercalar, epiotic and supraoccipital, and attaches dorsally with its opposite number in the midline. It is exposed in *Agonopsis*, *Bothragonus* and *Odontopyxis*.

Supraoccipital: The supraoccipital is a median bone, situated posterodorsally on the cranium. It is flattened and quadrate in dorsal view.

Basioccipital: The basioccipital is square in lateral view, being located posterodorsally on the cranium, and connected with the exoccipital dorsally, and the prootic and parasphenoid anteriorly. The posterior surface of the basioccipital is cylindrical, and articulates with the first centrum. Baudelot's ligament originates from the first centrum.

Auditory fenestra: The auditory fenestra (=subtemporal fossa — Birdsong, 1975) is a ligamentous membrane outside the auditory bulla, on the posterolateral surface of the cranium. It is surrounded by the prootic, pterotic, exoccipital, basioccipital and parasphenoid. The fenestra is well developed in *Bathyagonus* and *Xenertmus*, but small or rudimentary in other agonid fishes.

Discussion. Examination of the nasal bone and cranium disclosed the following interspecific differences: character 17, presence or absence of rostral plate; character 18, number of spines on rostral plate; character 19, condition of attachment between nasals; character 20, condition of anterior free nasal margin; character 21, condition of forward projection of nasal; character 22, condition of attachment between prevomer and ethmoid; character 23, number of ethmoidal spines; character 24, size of anterior process on ethmoid; character 25, position of articular facet of prefrontal; character 26, condition of attachment between frontal and parasphenoid; character 27, condition of dorsal margin of orbit; character 28; condition of exposed exoccipital; character 29, condition of bridge of trigeminal facialis chamber. The polarities of these characters were determined as follows (Tables 13-14).

Character 17: presence or absence of rostral plate. A rostral plate is present in *Freemanichthys*, *Agonus*, *Agonopsis* and Anoplagoninae. This character is unique amongst the species of Scorpaeniformes examined, and is regarded as a derived character.

Character 18: number of spines on rostral plate. Spines on the rostral plate number one in *Freemanichthys*, *Xenertmus* and *Odontopyxis*, and three in *Bathyagonus*, but are otherwise absent. Though information on these character conditions (presence or absence) is meager, the lack of a spine is inferred to be primitive on the basis of its commonality in the agonids. The single-spined condition is more widely distributed in agonids than that of three spines. Therefore, three spines on the rostral plate is considered to be a further derivation from a single-spined state.

Character 19: condition of attachment between nasals. The attachment between the nasals in agonid fishes are unique for Scorpaeniformes. In the majority of scorpaeniforms examined, except for Peristediinae, the nasals are narrowly separated from each other. In Peristediinae only, an attachment between the nasals was observed. Therefore, the presence of such an attachment is considered to be a derived state, and its absence in *Hypsagonus mozinoi* and Brachyopsinae, the primitive state. In *Anoplagonus*, the condition of the separated nasals is inferred as derived, owing to the presence of the rostral plate.

Character 20 : condition of anterior free nasal margin. The anterior free nasal margin is smooth in most agonids, but serrated in *Freemanichthys* and *Leptagonus*, and has a spine in *Podothecus*, *Agonus* and *Agonopsis*. In cottoid fishes, a free nasal margin is absent. Within Agonidae, a serrated margin and margin with a spine are confined to only five genera. Therefore, it is considered that a smooth margin is the primitive condition, and both the serrated margin and margin with a spine are derived conditions.

Character 21 : condition of forward projection of nasal. The forward projection of the nasal is observed only in Agoninae. Such a projection is unique amongst the scorpaeniform fishes examined, and is therefore inferred to be derived.

Character 22 : condition of attachment between prevomer and ethmoid. An attachment between the prevomer and ethmoid is absent in most agonid fishes, being present only in *Odontopyxis* and Brachyopsinae. In cottoid fishes, including Liparididae, an attachment is also absent (Taliev, 1955 ; Yabe, 1985 ; Kido, 1988), and the presence of such an attachment in some agonids is considered to be a derived condition.

Character 23 : number of ethmoidal spines. Ethmoidal spines number one in *Freemanichthys*, and two in *Leptagonus frenatus*, *L. leptorhynchus*, *Podothecus* and *Agonopsis vulsa*, but are absent in other agonids. Such spines are absent in cottoid fishes and Hexagrammoidei (Quast, 1965 ; Yabe, 1985 ; Kido, 1988). Accordingly, the absence of ethmoidal spines is regarded as the primitive condition.

Character 24 : size of anterior process on ethmoid. The anterior process on the ethmoid is large in Agoninae, and small in other agonids. In cottoid fishes examined, the process was small or absent. Therefore, a large process is judged to be a derived condition.

Character 25 : position of articular facet of prefrontal. The articular facet of the prefrontal is anterior in *Tilesina*, *Brachyopsis* and *Pallasina*, and posterior in other agonids. Generally, the facet articulates with the lachrymal and forms the anterior margin of the orbit. This condition is widely observed in scorpaeniforms. In *Tilesina*, *Brachyopsis* and *Pallasina*, however, the anterior part of head is cylindrical, and elongate. The elongation of the ethmoidal region appears to involve a forward shift of the articular facet, along with elongation of the lachrymal. As a result, the anterior margin of the orbit is formed by a membrane. Therefore, it is considered that an anterior articular facet is a derived condition, the posterior position being primitive.

Character 26 : condition of attachment between frontal and parasphenoid. Attachment of the frontal and the parasphenoid occurs in *Hypsagonus proboscidalis*, *H. jordani*, *Aspidophoroides*, *Anoplagonus*, *Agonopsis sterletus* and *A. chiloensis*, but does not occur in other agonids. Considering the posterior margin of the orbit in cottoid fishes, Yabe (1985) recognized two conditions, a parasphenoid-pterotic junction and a parasphenoid-prootic junction. Furthermore, he regarded the former to be the derived condition, on the basis of comparison with generalized percoid fishes. In the present study, the parasphenoid-frontal junction in some agonids is an unique condition among the Scorpaeniformes (Matsubara, 1943 ; Matsubara and Ochiai, 1955 ; Quast, 1965 ; Ueno, 1970 ; Yabe, 1985 ; Kido, 1988). It is therefore considered that the parasphenoid-frontal junction is the derived condition.

Character 27: condition of dorsal margin of orbit. The dorsal margin of the orbit is convex in Percidinae, and concave in other agonids. The concave condition is generally observed in scorpaeniforms, but in the liparidids, *Crystallichthys*, *Nectoliparis*, *Paraliparis* and *Eumicrotremus*, the convex condition occurs (Kido, 1988). Thus, the convex condition is regarded as the derived state.

Character 28: condition of exposed exoccipital. An exposed exoccipital is a unique condition among both agonid fishes and other scorpaeniforms. It has been observed in *Agonopsis*, *Bothragonus* and *Odontopyxis*. Leipertz (1988) paid attention to the unique exoccipital pit of *Bothragonus swani*, and discussed it as a mimic of sponges and ascidians, so as to reduce predation. Besides the matter of functional consideration, the formation of such a pit, involving the exposed exoccipital, is considered to be a derived condition.

Character 29: condition of bridge of trigeminal facialis chamber. The bridge of the trigeminal facialis chamber is absent in *Hypsagonus jordani*, *Percis japonicus*, *Agonus*, *Bothragonus swani*. With reference to cottoid fishes, Yabe (1985) proposed three conditions for this character, a wide vertical bridge, a narrow vertical bridge, and absence of the bridge. Yabe (1985) considered that a wide bridge was the primitive state, a narrow bridge was intermediate, and absence of the bridge was the derived state. In the Agonidae, two states only are considered, presence or absence of the bridge, because it was difficult to distinguish between wide and narrow conditions. In addition, such a bridge occurs in most scorpaeniform fishes. Accordingly, it is regarded that absence of the bridge is the derived state.

7. Pectoral girdle (Figs. 81-82, Table 15)

Description. The agonid pectoral girdle comprises a series of bones supporting the pectoral fin, and consists of the tabular, posttemporal, cleithrum, postcleithrum, scapula, coracoid, and actinosts.

Tabular: The tabular is a small, flattened bone, being one of elements of the cranial sensory canal. It is attached to the pterosphenoid anteriorly, and to the parietal posteriorly. There is a single tabular in *Hypsagonus*, *Percis*, *Agonopsis*, *Bothragonus*, *Bathyagonus*, *Xenertmus*, *Odontopyxis*, *Stellerina*, *Chesnonia*, *Ocella*, *Tilesina*, *Brachyopsis*, and *Pallasina*. In *Freemanichthys*, *Leptagonus*, *Podothecus*, *Agonus*, *Ulcina*, *Aspidophoroides* and *Anoplagonus*, however, a tabular is absent.

Posttemporal: The posttemporal is a triangular bone connecting the pectoral girdle with the cranium. It is tightly attached to the epiotic anterodorsally, and the intercalar anteroventrally.

Supracleithrum: The supracleithrum is rod- or fan-like, and is placed between the posttemporal and the cleithrum. Baudelot's ligament is attached to its medial surface.

Cleithrum: The cleithrum is the largest bone of the pectoral girdle, and is recurved anteromedially. The dorsal section of the cleithrum is attached laterally to the supracleithrum, posterodorsally to the postcleithrum, and anteromedially to the epipleural rib. The posterior margin has a symphysis with the scapula and coracoid. In *Hypsagonus*, the posteroventral corner of the cleithrum meets the ventral surface of the body at an acute angle, whereas in other agonids, it meets without an angle. Ventrally, the cleithrum is connected with its opposite number,

via the pelvis.

Postcleithrum: The postcleithrum is an elongate, plate-like bone, and is attached to the upper part of the cleithrum. The postcleithrum occurs one in *Leptagonus decagonus*, but two in other agonids.

Scapula: The scapula is a saddle-like bone, its connection with the posterodorsal margin of the cleithrum enclosing a hole between the two elements. Posteriorly, the scapula supports one to three actinosts.

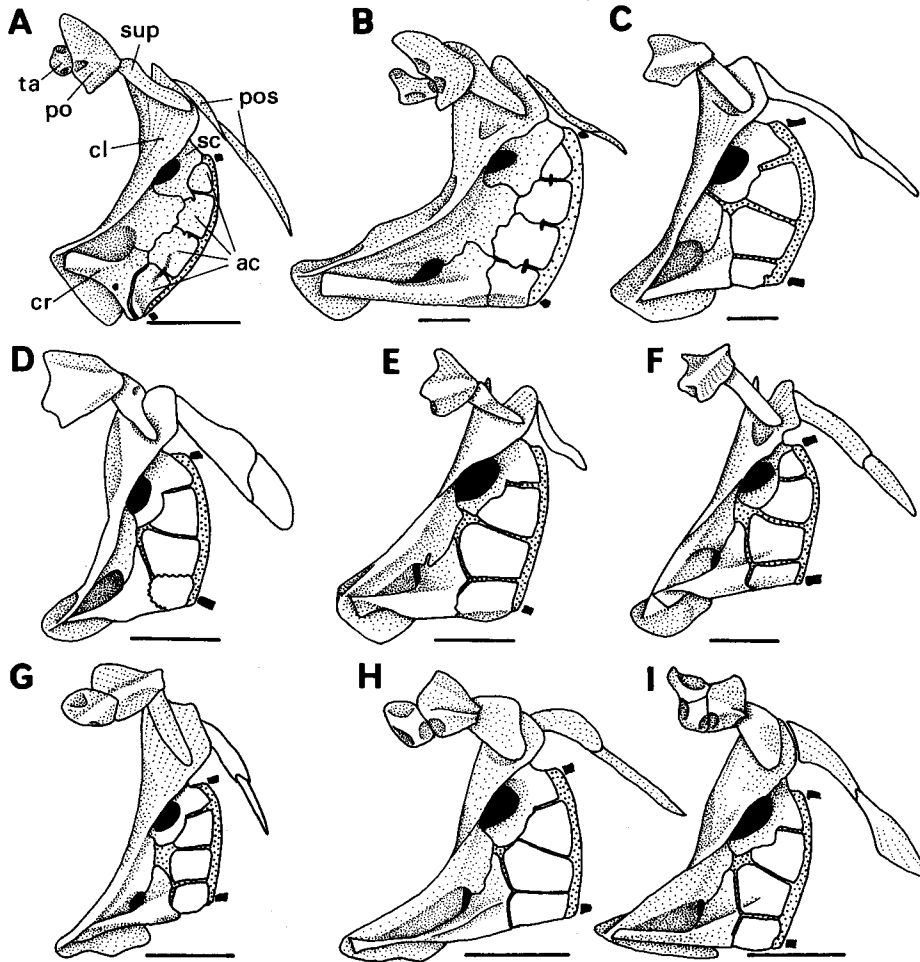

Fig. 81. Lateral aspect of the pectoral girdle in the family Agonidae. A, *Hysagonus quadricornis*; B, *Percis japonicus*; C, *Podothecus acipenserinus*; D, *Agonus cataphractus*; E, *Leptagonus decagonus*; F, *Freemanichthys thompsoni*; G, *Agonopsis vulsa*; H, *Bathyagonus nigripinnis*; I, *Xenertmus latifrons*. ac, actinosts; cl, cleithrum; cr, coracoid; po, posttemporal; pos, postcleithrum; sc, scapula; sup, supracleithrum; ta, tabular bone. Scale bars indicate 5 mm.

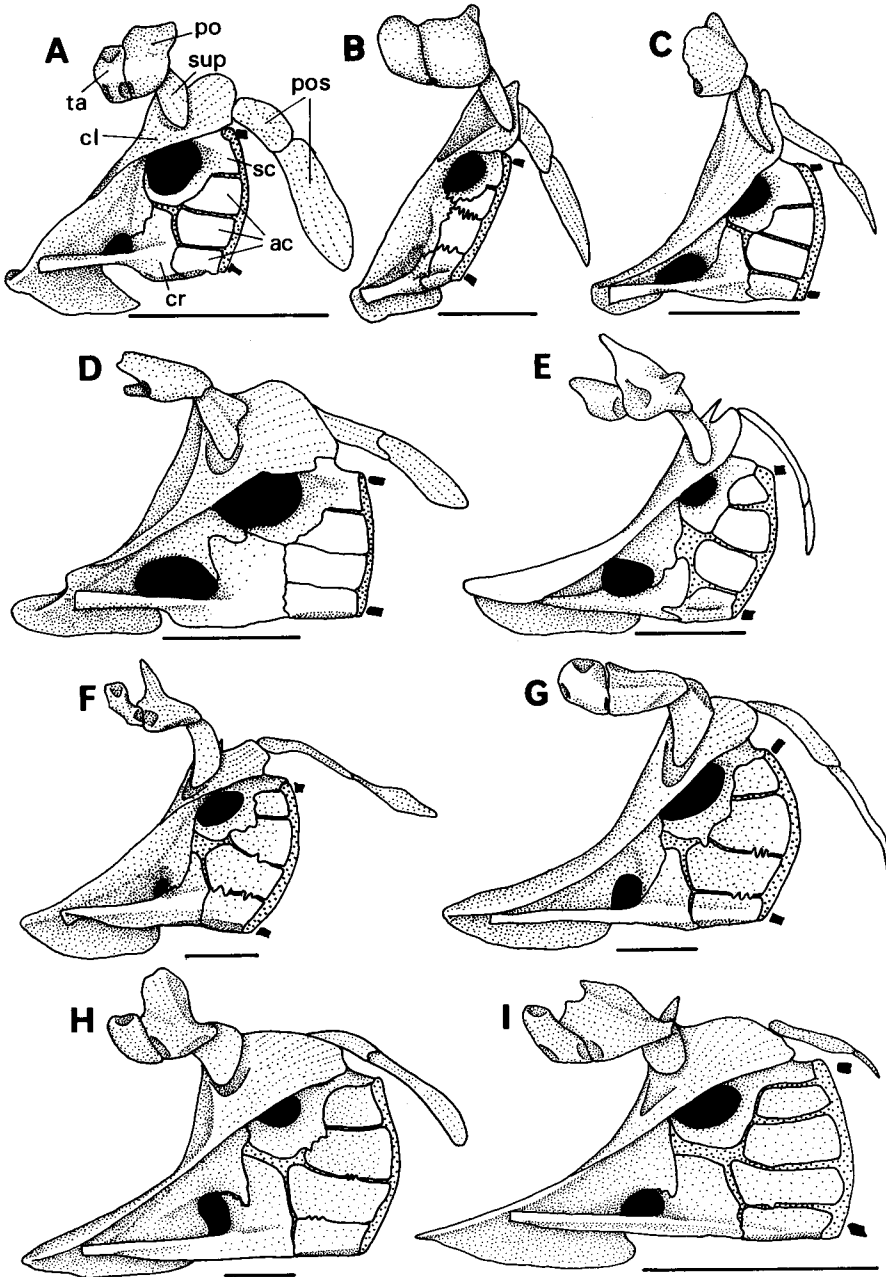

Fig. 82. Lateral aspect of the pectoral girdle in the family Agonidae. A, *Odontopyxis trispinosa*; B, *Bothragonus swani*; C, *Ulcina olriki*; D, *Aspidophoroides monopterygius*; E, *Stellerina xyosterna*; F, *Ocella dodecaedron*; G, *Tilesina gibbosa*; H, *Brachyopsis segaliensis*; I, *Pallasina barbata*. Scale bars indicate 5 mm. (abbreviations, see Fig. 81).

Table 15. Comparison of the pectoral girdle in the family Agonidae. D, derived; P, primitive.

Number of actinosts		Pores between actinosts		Tabular bone		Postcleithrum		taxa
four	P	present	P	one	P	two	P	Hypsagonus Percis
		absent	D					Brachyopsinae
three	D							
				absent	D			Leptagonus frenatus L. leptorhynchus Podothecus Agonus, Ulcina Bothragonus occidentalis Aspidophoroides Anoplagonus
four	P							Freemanichthys
three	D					one	D	Leptagonus decagonus

Coracoid: The coracoid is a L-shaped bone with an anteroventral projection, and is attached to the cleithrum both anterodorsally and anteroventrally. The anteroventral projection is short in *Hypsagonus* and *Bothragonus*, but long in other agonids. The coracoid supports a single actinost in *Hypsagonus*, *Percis* and *Bothragonus*, and two actinosts in other agonids.

Actinosts: The actinosts are small, square flattened bones, supporting the pectoral fin rays on their posterior margins. Four actinosts occur in *Hypsagonus*, *Percis*, *Freemanichthys*, *Stellerina*, *Ocella*, *Tilesina*, *Brachyopsis* and *Pallasina*, and three in other agonids. Pores among the actinosts are present in *Hypsagonus* and *Percis*, but absent in other agonids.

Discussion. The following interspecific variations were observed in the pectoral girdle: character 30, number of actinosts; character 31, condition of pore between actinosts; character 32, number of tabulars; character 33, number of postcleithra. The polarity of these characters were determined as follows (Table 15).

Character 30: number of actinosts. Four actinosts occur in Percidinae, Brachyopsinae and *Freemanichthys*, and three in other agonids. In cottoid fishes, actinosts generally number four, except for *Scorpaenichthys* with three (Yabe, 1985). Furthermore, actinosts usually number four in scorpaeniform fishes (Johnson, 1918;

Starks, 1930; Taranetz, 1941; Matsubara, 1943; Matsubara and Ochiai, 1955; Taliev, 1955; Watanabe, 1958; Quast, 1965; Ueno, 1970; Yabe, 1985; Kido, 1988). Three actinosts only have been recorded in *Paraliparis*, *Careproctus*, *Nectoliparis* of the liparidids (Kido, 1988), *Aederosebastes*, *Scorpaena*, *Neosebastes* of the scorpaenids, and *Alertichthys* of Congiopodidae. Therefore, it is considered that four actinosts are the primitive condition.

Character 31: condition of pores between actinosts. Pores between the actinosts in agonids were observed in Percidinae, but were absent in other agonids. Such pores are present in most cottoid fishes, although absent in Psychrolutidae (Yabe, 1985). The presence of such pores is regarded as the primitive condition.

Character 32: number of tabular bone. A single tabular bone occurs in Percidinae, Brachyopsinae, *Agonopsis*, *Bathyagonus*, *Xenertmus*, *Odontopyxis*, *Bothragonus swani*, but is absent in other agonids. Two or three tabulars are found in cottoid fishes (Yabe, 1985), usually one (rarely absent) in liparidids (Kido, 1988), and one in scorpaenids (Matsubara, 1943). Therefore, absence of the tabular is judged to be the derived condition.

Character 33: number of postcleithra. A single postcleithrum, reduced in length, is found in *Leptagonus decagonus*, but two in other agonids. Because two postcleithra are usually observed in cottoid fishes (Yabe, 1985), it is considered that a single postcleithrum represents a derived condition.

8. Pelvic girdle (Figs. 83-84, Table 16)

Description. The agonid pelvic girdle comprises the pelvis and pelvic fin rays.

Pelvis: The pelvis is a thin bone, with a large hole in the center, and shoe-like in lateral view. It is attached to its opposite number in the midline. The anterolateral side of the pelvis is attached to the ventromedial side of the cleithrum. A posterodorsal, postpelvic process is well developed in the midline in *Bothragonus*, but rudimentary or absent in other agonids. The subpelvic process is tiny or absent, and situated posteroventrally on midline. An inner pelvic keel is present on the medial margin. The interosseous space is incompletely margined by the inner pelvic keel in Brachyopsinae and *Bathyagonus pentacanthus*, but completely margined in other agonids. The lateral margin of the pelvis has a suprapelvic keel anterodorsally, and a subpelvic keel posteroventrally.

Pelvic fin rays: The pelvic fin rays are composed of one spine and two soft rays, and are attached to the posterior end of the pelvis.

Discussion. The following interspecific variations in the pelvic girdle were recognized: character 34, condition of postpelvic spine; character 35, condition of inner pelvic keel. The polarities of these characters were determined as follows (Table 16).

Character 34: condition of postpelvic spine. The postpelvic process is well developed in *Bothragonus*, but absent or poorly developed in other agonids. In cottoid fishes, the process is usually poorly developed (Yabe, 1985), and in liparidids, is well developed only in those equipped with a disk (Kido, 1988). Though the function of the postpelvic process is not clear, it appears to increase the muscle attachment surface. Therefore, it is considered that a well developed postpelvic process is the derived condition.

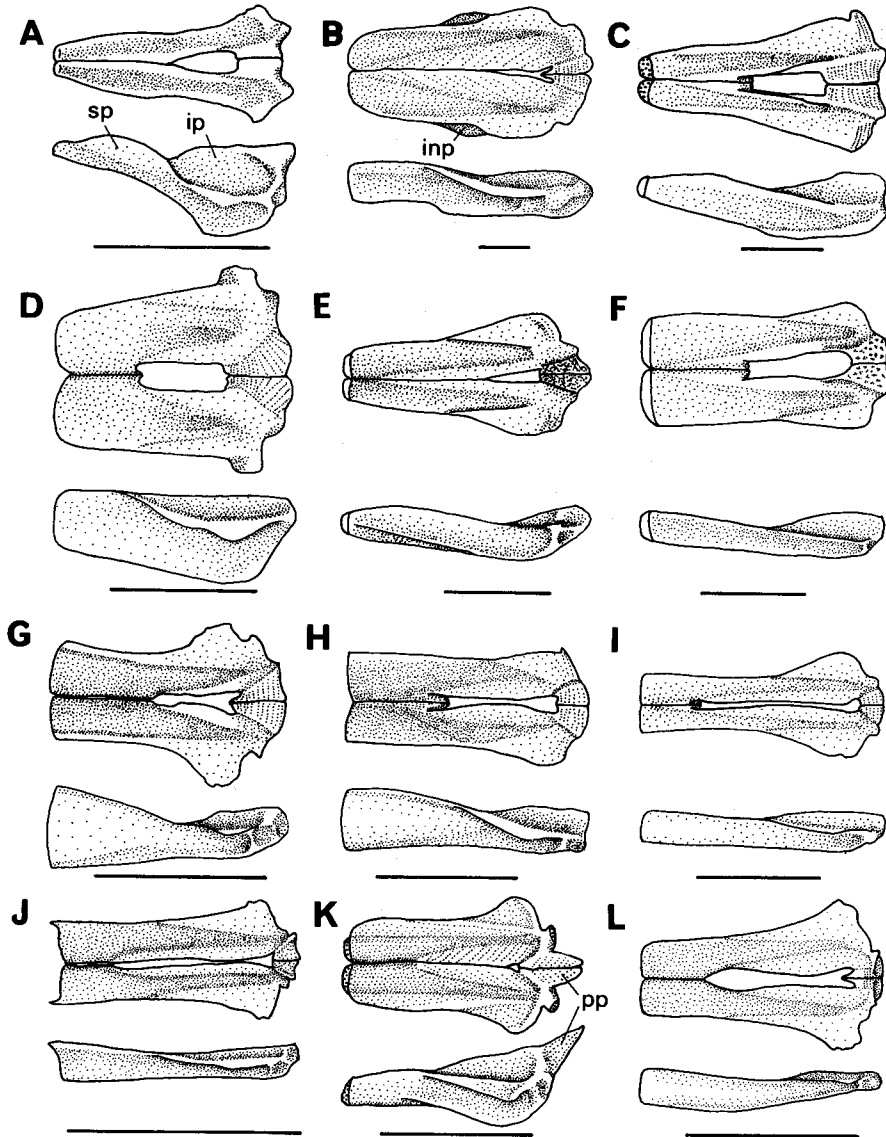

Fig. 83. Dorsal and lateral aspects of the pelvic girdle in the family Agonidae. A, *Hypsagonus quadricornis*; B, *Percis japonicus*; C, *Podothecus acipenserinus*; D, *Agonus cataphractus*; E, *Leptagonus decagonus*; F, *Freemanichthys thompsoni*; G, *Agonopsis vulsa*; H, *Bathyagonus nigripinnis*; I, *Xenertmus latifrons*; J, *Odontopyxis trispinosa*; K, *Bothragonus swani*; L, *Ulcina obriki*. inp, infrapelvic keel; ip, inner pelvic keel; pp, postopelvic process; sp, suprapelvic keel. Scale bars indicate 5 mm.

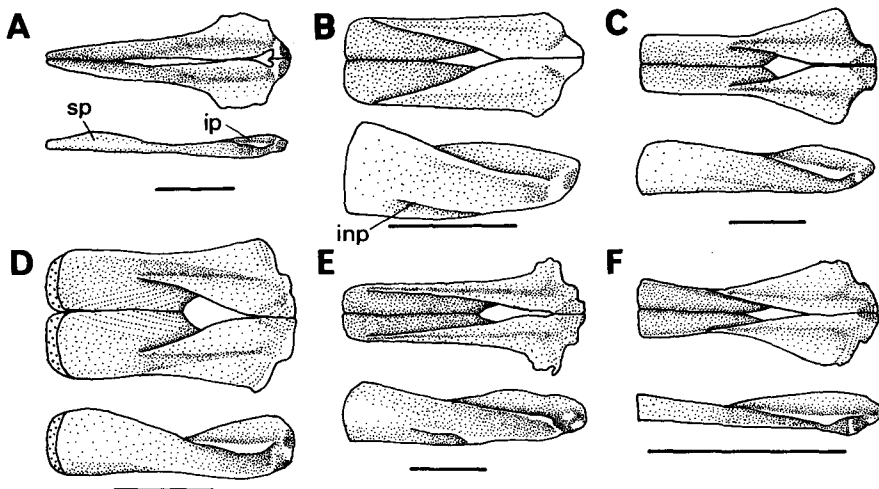

Fig. 84. Dorsal and lateral aspects of the pelvic girdle in the family Agonidae. A, *Aspidophoroides monopterygius*; B, *Stellerina xyosterna*; C, *Tilesina gibbosa*; D, *Ocella dodecaedron*; E, *Brachyopsis segaliensis*; F, *Pallasina barbata*. Scale bars indicate 5 mm. (abbreviations, see Fig. 83).

Table 16. Comparison of the pelvic girdle in the family Agonidae. D, derived; P, primitive.

Postpelvic process		Inner pelvic keel entirely margining		taxa
absent	P	present	P	Percidinae Agoninae Anoplagoninae
present	D			Bothragonus
absent	P	absent	D	Bathyagonus pentacanthus Brachyopsinae

Character 35: condition of inner pelvic keel. An inner pelvic keel completely margining the interosseous space is present in most agonid fishes. However, the margin is incomplete in Brachyopsinae and *Bathyagonus pentacanthus*. The interosseous space is completely margined by a keel in all cottoid fishes (Yabe, 1985). Therefore, the absence of the condition of the inner pelvic keel entirely margining the osseous space is considered to be a derived condition.

9. Vertebrae and pterygiophores (Figs. 85-91, Table 17)

Description. These elements include the vertebrae, pleural ribs, epipleural ribs,

proximal pterygiophores, distal pterygiophores, and dorsal and anal fin rays.

Vertebrae: The vertebrae include both abdominal and caudal elements. The abdominal vertebrae are defined as those anterior elements which lack a haemal spine. The caudal vertebrae are the posterior elements, characterized by the presence of a haemal spine.

Generally, the vertebral centrum possesses a neural spine with a neural arch dorsally, and a haemal spine with a haemal arch ventrally. However, the first neural arch is not formed in agonids. Although a neural spine is absent from the first centrum in *Bothragonus*, it is usually present in other agonids. Up to the last three abdominal vertebrae possess a pair of ventrolateral parapophysis, which become larger posteriorly.

Pleural ribs: The pleural ribs are thin rod-like bones, attached to the tip of the parapophysis. Such bones are present in *Hypsagonus*, but absent in other agonids.

Epipleural ribs: The epipleural ribs are needle-like, and are attached to the lateral surface of the abdominal vertebrae and anterior caudal vertebrae. They extend into the horizontal myoseptum between the epaxial and hypaxial muscles.

Proximal pterygiophores: The proximal pterygiophores are thin, wedge-shaped bones inserted into the interneural and interhaemal spaces, and supporting the dorsal and anal fin rays. The insertion pattern of bone to space is usually one to one (rarely two to one).

The first dorsal proximal pterygiophore is inserted into the second interneural space in *Hypsagonus* and *Percis*, the third space in *Freemanichthys*, and the fifth

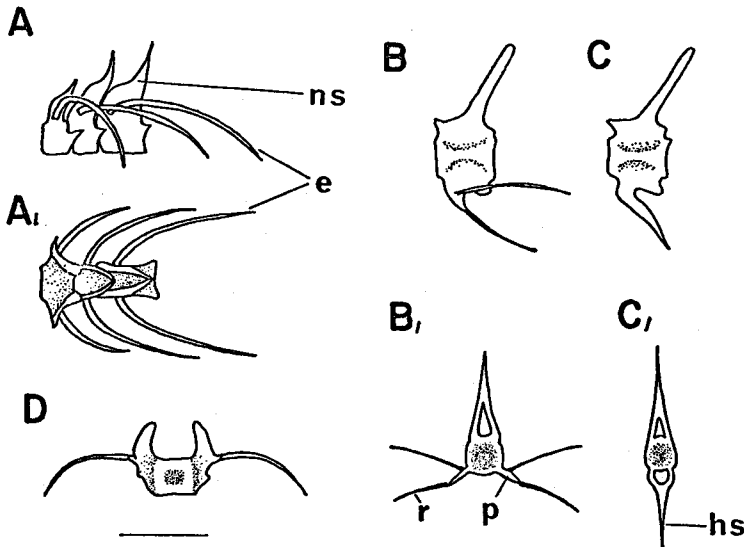

Fig. 85. Lateral (A, B, C), dorsal (A₁) and frontal (B₁, C₁, D) aspects of the first, second, third, eighth and 14th vertebra in *Hypsagonus jordani*. A and A₁, the first to third vertebra; B and B₁, the eighth vertebrae; C and C₁, the 14th vertebrae; D, first vertebrae. e, epipleural rib; hs, haemal spine; ns, neural spine; p, parapophysis; r, pleural rib.

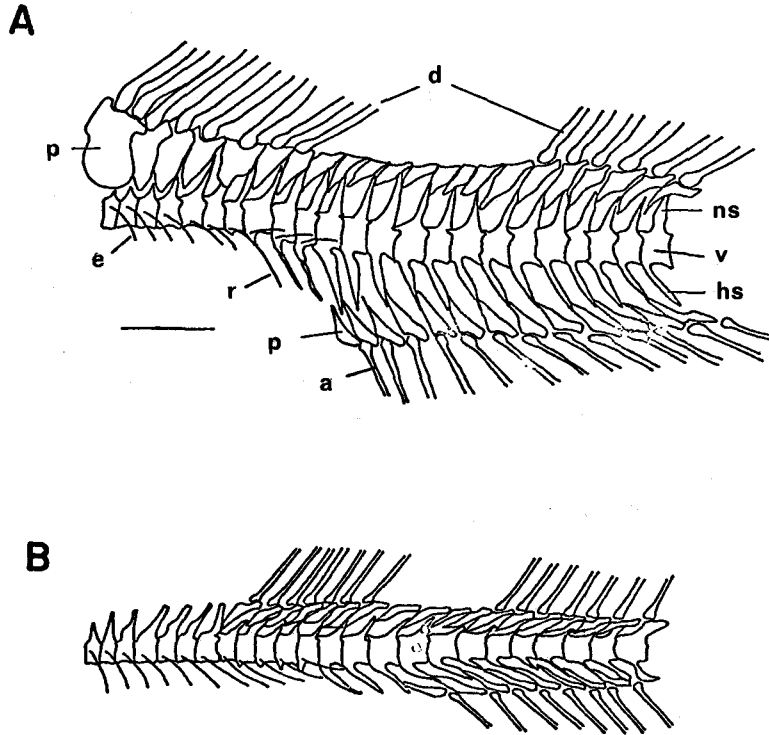

Fig. 86. Lateral aspect of the abdominal and anterior caudal vertebrae, and accessory bones in two agonid fishes. *Hypsagonus jordani*; B, *Xenertmus latifrons*. a, anal fin ray; d, dorsal fin ray; e, epipleural rib; hs, haemal spine; ns, neural spine; p, proximal pterygiophore; r, pleural rib; v, vertebra.

space or posterior in other agonids. The bone is enlarged, supporting two dorsal spines in *Hypsagonus* and *Percis*, but is not enlarged, supporting a single spine or ray in other agonids.

In most agonids, each dorsal proximal pterygiophore supporting the spinous dorsal is continuously inserted into each interneural space. The insertion of this bone is discontinuous, being absent from the fifth or sixth interneural space in *Percis*, the sixth or seventh in *Hypsagonus*, and the ninth in *Freemanichthys*.

The rayless interdorsal pterygiophores (Mabee, 1988) are continuously inserted into interdorsal spaces in the family Agonidae. In *Percis*, however, these bones are almost absent, although two or three rudimentary elements are present. There is no insertion of the proximal pterygiophore into the 12th interneural space in *Bothragonus swani*.

The first anal proximal pterygiophore is inserted into the anterior interhaemal space of the caudal vertebrae, i.e., the first interhaemal space in *Hypsagonus jordani*, *Podothecus*, *Stellerina*, *Chesnonia*, *Ocella*, *Tilesina* and *Brachyopsis*, the second interhaemal space in *Hypsagonus* (except for *H. jordani*), *Agonus* and *Agonopsis*,

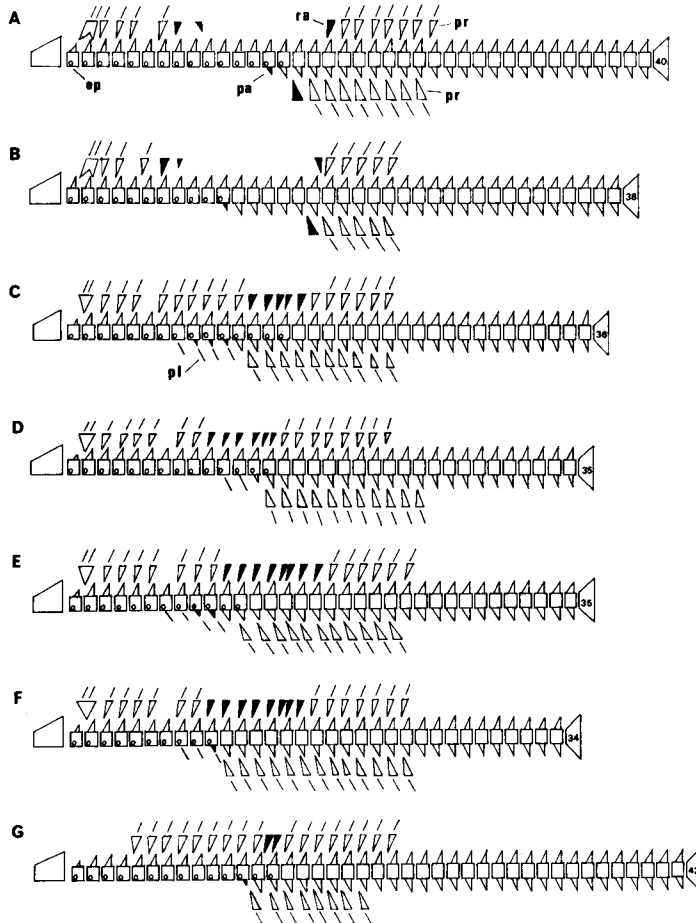

Fig. 87. Schematic representation of the vertebrae and appendicular bones. A, *Percis japonicus*; B, *P. matsuii*; C, *Hypsagonus quadricornis*; D, *H. jordani*; E, *H. proboscidalis*; F, *H. mozinoi*; G, *Podothecus acipenserinus*. ep, epipleural rib; pa, parapophysis; pl, pleural rib; pr, proximal pterygiophore; ra, rayless pterygiophore. Numerals indicate the number of vertebrae.

and the third or more posterior interhaemal spaces in other agonids.

Distal pterygiophores: The agonid distal pterygiophore is tiny, situated between the proximal pterygiophore and the ray.

Dorsal and anal fin rays: Each dorsal and anal fin ray is generally supported by a proximal pterygiophore. In agonids, the dorsal fin consists of two parts, spinous rays and soft rays. Spinous rays are absent in *Ulcina*, *Aspidophoroides* and *Anoplagonus*.

Discussion. The following interspecific differences were observed: character 36, condition of pleural ribs; character 37, insertion of first dorsal pterygiophore;

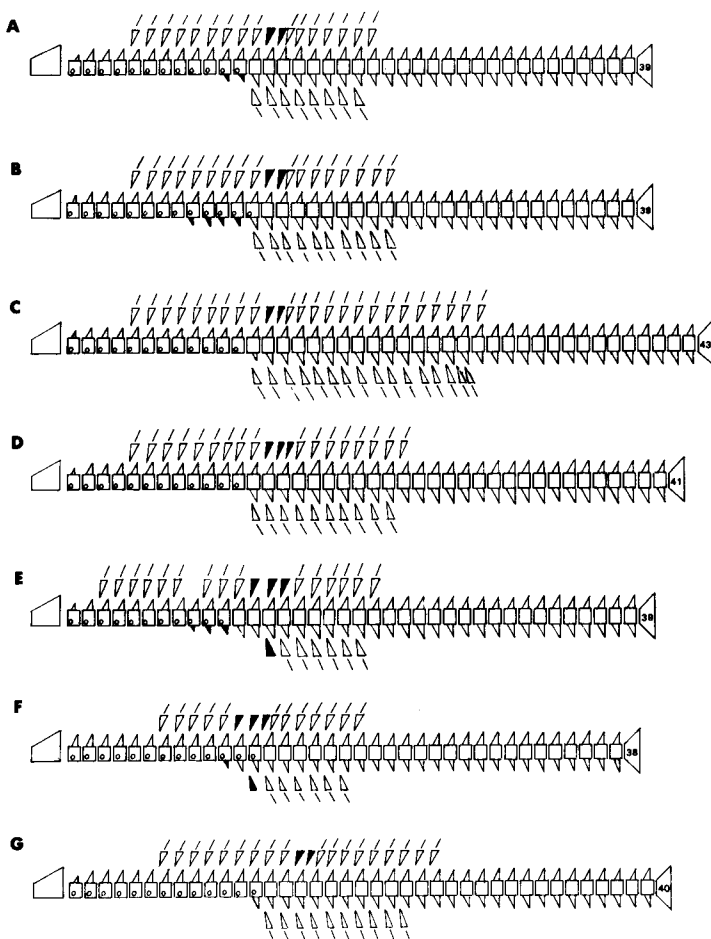

Fig. 88. Schematic representation of the vertebrae and appendicular bones. A, *Podothecus veterinus*; B, *P. sturioides*; C, *P. sachi*; D, *P. hamlini*; E, *Freemanichthys thompsoni*; F, *Agonus cataphractus*; G, *Agonopsis vulsa*. For abbreviations, see Fig. 87.

character 38, number of spines on first dorsal pterygiophore; character 39, condition of spinous dorsal pterygiophores; character 40, condition of interdorsal pterygiophores; character 41, insertion of first anal pterygiophore. The polarities of these characters were determined as follows (Table 17).

Character 36: condition of pleural ribs. Pleural ribs are rudimentary in *Hypsagonus*, and absent in other agonids. These bones are present on the abdominal vertebrae in most cottoid fishes (Yabe, 1985), hexagrammoid fishes (Quast, 1965), and other scorpaeniforms. Therefore, it is considered that the presence of pleural ribs is the primitive condition.

Character 37: insertion of first dorsal pterygiophore. The insertion of the first

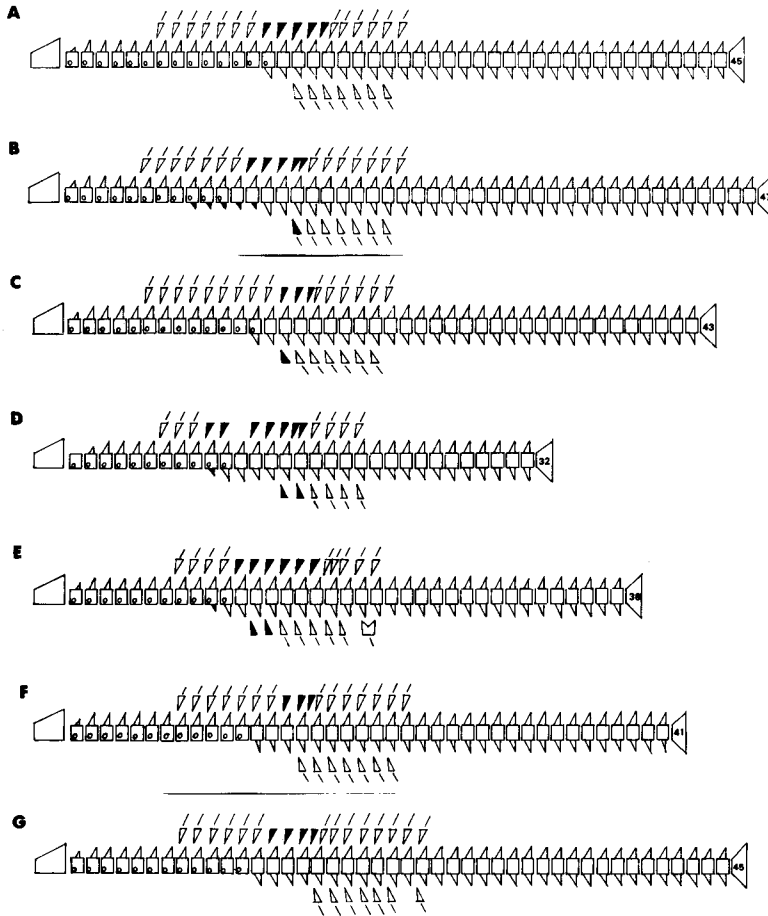

Fig. 89. Schematic representation of the vertebrae and appendicular bones. A, *Leptagonus decagonus*; B, *L. frenatus*; C, *L. leptorhynchus*; D, *Bothragonus swani*; E, *B. occidentalis*; F, *Xenertmus latifrons*; G, *X. leiops*. For explanation, see Fig. 87.

dorsal pterygiophore is anterior in Percidinae and *Freemanichthys*, but is posterior in other agonids. It is inserted into the first or the second interneural space in most cottoid fishes (Yabe, 1985), the third or the fourth in the Cyclopteridae, the first or the second in the Hexagrammidae and Zaniolepididae, the fifth or the sixth in the Anoplopomatidae, and the third in most other scorpaeniforms. Accordingly, an anterior insertion of the first dorsal pterygiophore in agonids is regarded as the primitive condition.

Character 38: number of spines on first dorsal pterygiophore. Spines on the first dorsal pterygiophore number two in Percidinae, one in most agonids, and are absent altogether in *Ulcina*, *Aspidophoroides* and *Anoplagonus*. A single spine occurs in Cyclopteridae, *Pleurogrammos azonus*, Anoplopomatidae, Hoplichthyidae,

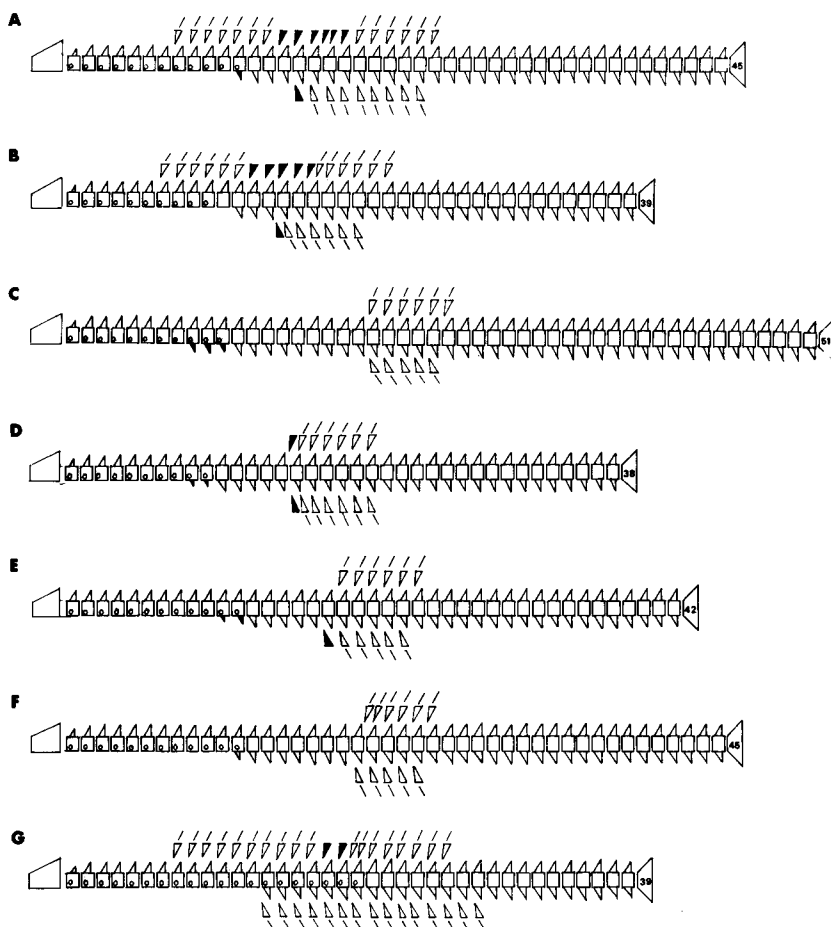

Fig. 90. Schematic representation of the vertebrae and appendicular bones. A, *Bathyanonus nigripinnis*; B, *B. alascanus*; C, *Aspidophoroides monopterygius*; D, *Ulcina olriki*; E, *Anoplagonus inermis*; F, *A. occidentalis*; G, *Ocella dodecaedron*. For explanation, see Fig. 87.

Platycephalinae and Peristediinae, but two in other scorpaeniforms. Therefore, it is considered that two rays on the first dorsal pterygiophore are the primitive state.

Character 39: condition of spinous dorsal pterygiophores. The spinous dorsal pterygiophores are discontinuous in Percidinae and *Bothragonus*. The correspondence between spinous dorsal pterygiophores and interneural spaces was basically one-to-one (rarely two-to-one) in the scorpaeniforms examined. Such correspondence was not observed in *Hemitripterus villosus* and hexagrammid fishes. Mabee (1988) discussed the phylogenetic implications of loss or increase in the number of dorsal spines and pterygiophores in centrarchid fishes, and considered that loss or increase of dorsal spines and pterygiophores appeared to have frequently occurred

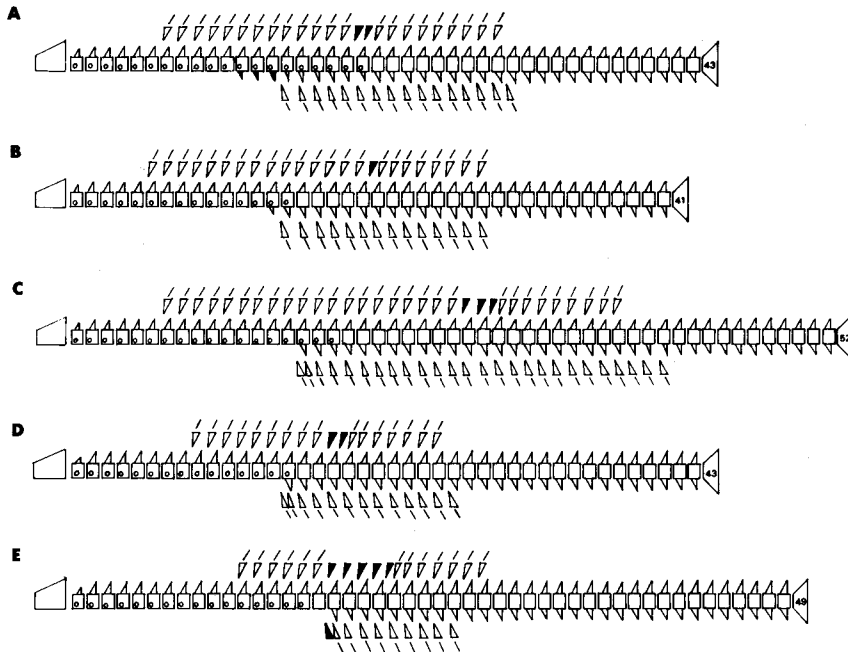

Fig. 91. Schematic representation of the vertebrae and appendicular bones. A, *Ocella iburia*; B, *O. kasawai*; C, *Tilesina gibbosa*; D, *Brachyopsis segaliensis*; E, *Palasina barbata*. For explanation, see Fig. 87.

anteriorly or posteriorly. Therefore, it is regarded that the discontinuous condition of spinous dorsal pterygiophores is derived.

Character 40: condition of interdorsal pterygiophores. A discontinuous series of rayless interdorsal pterygiophores occurs in both *Percis* and *Bothragonus*, and is absent in *Ulcina*, *Aspidophoroides* and *Anoplagonus*. In most cottoid fishes, dorsal spine and ray bearing pterygiophores are continuous, without rayless pterygiophores. However, *Blepsias cirrhosus* has two rayless pterygiophores included in a continuous series. Therefore, the discontinuous condition of rayless interdorsal pterygiophores in agonids is judged to be derived.

Character 41: insertion of first anal pterygiophore. The first anal pterygiophore is inserted into anterior (first or second) interhaemal spaces in *Hypsagonus*, *Percis japonicus*, Agoninae and Brachyopsinae, and posterior spaces in other agonids. In most cottoid and hexagrammoid fishes, this bone is inserted into the first interhaemal space. Such is also generally observed in scorpaenoid fishes. It is therefore considered that insertion of the first anal pterygiophore into the anterior interhaemal space is the primitive condition.

10. Caudal skeleton (Fig. 92, Table 18)

Description. The caudal skeleton in the Agonidae consists of the second preural centrum, a bony plate fused with the first preural centrum, the parhypural

Table 17. Comparison of the vertebrae and pterygiophores in the family Agonidae. IA, insertion of anal pterygiophore; ID, interdorsal pterygiophore; IFD, insertion of first dorsal pterygiophore; NR, number of rays on the first spinous dorsal pterygiophore; PR, pleural ribs; SDP, spinous dorsal pterygiophore. D, derived; P, primitive.

PR		IFD		NR		SDP		ID		IA		taxa				
present	P	anterior	P	two	P	discontinuous	D1	continuous	P	anterior	P	Hypsagonus				
absent	D							discontinuous	D1			one	D1	continuous	P	continuous
		posterior	D	Percis matsuii												
		posterior	D	discontinuous	D1	continuous	P	continuous	P	anterior	P	anterior	P	Freemanichthys		
														continuous	P	Podothecus, Agonus Agonopsis, Stellerina Chesnonia, Occella Tilesina Brachyopsis Pallasina
														discontinuous	D1	posterior
		continuous	P	continuous	P	continuous	P	continuous	P	posterior	D	Bathyagonus Xenertmus Odontopyxis				
absent	D2	absent	D2	absent	D2	absent	D2	absent	D2	absent	D2	Ulcina Aspidophoroides Anoplagonus				

and hypural plates, epurals, and unbranched caudal fin rays.

Second preural centrum: The second preural centrum articulates anteriorly with the third preural centrum, and posteriorly with the first preural centrum. It bears thin, expanded neural and haemal spines.

First preural centrum: In the family Agonidae, the first preural centrum arises from the last vertebra, and is fused with the parhypural and hypurals.

Hypural: The hypural is a thin plate fused with the first preural centrum at its anterior tip, and with a parhypural along its lower margin. The posterior margin of the hypural supports the caudal fin rays.

Parhypural: The parhypural is fused with the first preural centrum on its anterior margin, and with the hypural on its dorsal margin. The basal part of this bone includes the last pore of the haemal arch.

Epural: The epural is a laminar bone, situated above the dorsal margin of the first preural centrum. Two epurals occur in *Hypsagonus*, *Percis* and *Bothragonus*, and one in all other agonids.

Caudal fin rays: The caudal fin rays are unbranched, and include both principal and procurrent rays. For this study, the principal rays were defined as those present on the hypural and parhypural. They are divided into upper and lower lobes by the hypural notch. The procurrent rays are the rays anterior to the principal caudal rays.

Discussion. In the agonid caudal skeleton, the only interspecific variation found concerned the number of epurals (Character 42). The polarity of this character was determined as follows (Table 18).

Character 42: number of epurals. Two epurals occur in Percidinae and *Bothragonus*, and one in other agonids. Three are found in most cottoid (Yabe, 1985), hexagrammoid, and scorpaenoid fishes. Therefore, the presence of two epurals is considered to be the primitive condition in agonid fishes.

Table 18. Comparison of the caudal skeleton in the family Agonidae. D, derived; P, primitive.

Number of epural		taxa
two	P	<i>Hypsagonus</i> <i>Percis</i> <i>Bothragonus</i>
one	D	<i>Freemanichthys</i> , <i>Leptagonus</i> <i>Podothecus</i> , <i>Agonus</i> <i>Agonopsis</i> <i>Bathyagonus</i> , <i>Xenertmus</i> <i>Odontopyxis</i> , <i>Ulcina</i> <i>Aspidophoroides</i> , <i>Anoplagonus</i> <i>Brachyopsinae</i>

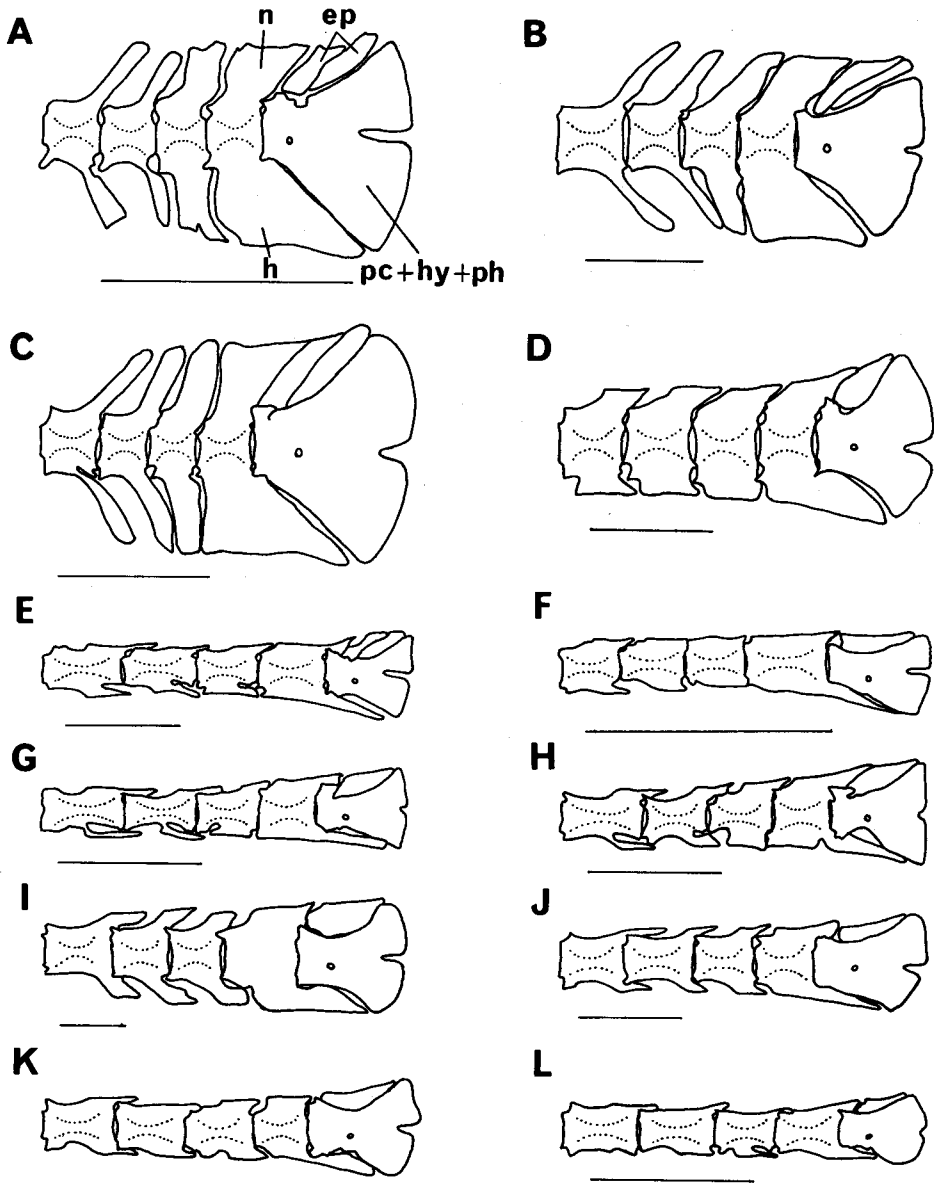

Fig. 92. Lateral aspect of the caudal skeleton in 12 species of the family Agonidae. A, *Hypsagonus quadricornis*; B, *H. jordani*; C, *Percis japonicus*; D, *Podothecus sachi*; E, *Leptagonus leptorhyncus*; F, *Aspidophoroides monopterygius*; G, *Xenertmus latifrons*; H, *Bathyaqonus nigripinnis*; I, *Ocella kasawai*; J, *Tilesina gibbosa*; K, *Brachyopsis segaliensis*; L, *Pallasina barbata*. ep, epural; h, haemal spine; n, neural spine; pc+hy+ph, a bone fused with preural centrum 1, hypural and parhypural. Scales indicate 5 mm.

VII. Phylogenetic classification of the family Agonidae

1. Monophyly of the family Agonidae

The family Agonidae is currently belonging to the suborder Cottoidei, order Scorpaeniformes. The monophyly of the family has been discussed only by Yabe (1985), in his study of the interfamilial relationships of the superfamily Cottoidea, on the basis of a few agonid species (*Hypagonus jordani*, *Podothecus sachi* and *Tilesina gibbosa*). And this family was defined as the sister group of Hemitripterae (Fig. 93). The monophyly of the family Agonidae is reexamined below.

Circumorbital bones: The agonid circumorbital bones are composed of four elements, the lachrymal, and the first, second and fifth infraorbitals. In scorpaeniform fishes, the lachrymal, and the first and second infraorbitals are always present, except in the Caracanthidae. The family Caracanthidae has a single enlarged infraorbital, which appears to be a fusion of the first and second infraorbitals. However, the condition of the third to fifth infraorbitals is variable in this order (Allis, 1909; Taranetz, 1941; Taliev, 1955; Matsubara and Ochiai, 1955; Watanabe, 1958; Quast, 1965; Yabe, 1981; Kido, 1988). In cottoid fishes, presence of the third, fourth and fifth infraorbitals is common. It is therefore considered that three infraorbitals in agonids are a derived condition.

Jaws, suspensorium and opercular apparatus: Meaningful patterns of interfamilial variations could not be determined.

Hyoid apparatus: The agonid hyoid apparatus is characterized by five or six branchiostegal rays, and has been described by some investigators (McAllister, 1968; Kusaka, 1974; Yabe, 1985; Leipertz, 1985 and 1988), who did not, however, refer to differences in these bones. Branchiostegal rays usually number seven in Scorpaenoidei, Platycephalidae, Hexagrammidae and Psychrolutidae, and six in Anoplomatidae, Cottoidea, Liparididae and Cyclopteridae (Matsubara, 1943; McAllister, 1968; Yabe, 1985; Kido, 1988). Thus, six or fewer branchiostegal rays are regarded as the derived condition.

Branchial apparatus: Among scorpaeniform fishes, the agonid branchial apparatus, including the basihyal, is characterized by the latter being tiny or absent, the absence of the suspensory pharyngeal and a tooth plate on the third epibranchial, and one upper pharyngeal only being present. In his study of the cottoid branchial apparatus, Yabe (1985) paid attention to the condition of four characters, suspensory pharyngeal, number of upper pharyngeals (pharyngobranchials in Yabe, 1985), tooth plate on the third epibranchial, and basihyal. Except for the basihyal, these characters as described by Yabe (1985) had a similar status in the agonids examined.

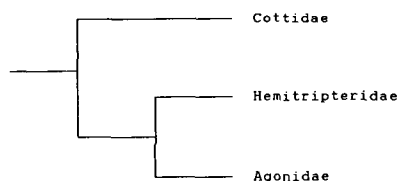

Fig. 93. Hypothetical branching pattern of the family Agonidae and its relatives.

As in agonids, the basihyal is present or absent in cottoid fishes. In most of the Scorpaenoidei, Platycephalidae and Hexagrammoidei, the basihyal, suspensory pharyngeal, three upper pharyngeals and the tooth plate on the third epibranchial are present (Matsubara and Ochiai, 1955; Quast, 1965). The majority of cottoid fishes have neither a basihyal, a suspensory pharyngeal nor a tooth plate on the third epibranchial (Yabe, 1985). Cottoid upper pharyngeals number one or two. Therefore, the selected characters for the agonid branchial apparatus are considered to be derived.

Cranium: Meaningful patterns of interfamilial variations could not be determined.

Pectoral girdle: The agonid pectoral girdle includes one or no tabular bones and plate-like actinosts. The agonid pectoral girdle has been examined by several investigators (Regan, 1913; Starks, 1930; Yabe, 1985; Leipertz, 1985), who found it to be characterized by enlarged quadrate actinosts, like those of cottoid and hexagrammoid fishes (Starks, 1930; Taliev, 1955; Watanabe, 1958; Quast, 1965; Yabe, 1985). The actinosts are stick-like in scorpaenoid and platycephaloid fishes (Matsubara, 1943; Matsubara and Ochiai, 1955). Most cottoid fishes have two tabular bones (Yabe, 1985). Thus, these two characters in agonids are judged to be derived.

Pelvic girdle: The agonid pelvic girdle is characterized by having only one spine and two rays. In most of the scorpaeniform fishes examined, the pelvic fin has one spine and five rays, but a spine and three to five rays in the majority of cottoids (Yabe, 1985). Therefore, the presence of a spine and two rays in the pelvic fin is considered to be a derived condition.

Vertebrae and pterygiophores: The agonid vertebrae and pterygiophores are characterized by having the pleural and epipleural ribs attached directly to the parapophysis, absence of the stay, one ray on the last pterygiophore of the dorsal and anal fins, and Baudelot's ligament attached to the first centrum. Most of the scorpaeniform fishes examined had the attachment of the pleural and epipleural ribs to the parapophysis, the stay, two rays on the last pterygiophore of the dorsal and anal fins, and Baudelot's ligament attached to the basioccipital. Thus, these states of the agonid vertebrae and pterygiophores are considered to be derived.

Caudal skeleton: The agonid caudal skeleton is characterized by one or two epurals, and the hypural plates fused with the first preural centrum and the parhypural. The majority of scorpaeniform fishes have autogenous hypural plates from the first preural centrum, and three epurals (Monod, 1967, 1968; Yabe, 1985; Kido, 1988). Therefore, these character states in agonids are regarded as derived.

Other characters: In addition to the above osteological characters, the family Agonidae is characterized in having bony plates on the body, and the absence of a swim bladder. Such bony plates are absent in most of the scorpaeniform fishes, whereas the swim bladder is present in the majority. Therefore, these two characters in agonid fishes are considered to be derived.

As a result, the family Agonidae is regarded as a monophyletic group, based on the combination of synapomorphies discussed above.

2. Characters and conditions

In the comparative anatomy of the family Agonidae, 42 phylogenetically useful characters were recognized. The polarity of each character is described as follows.

Characters	Polarity	
	Primitive	Derived
1. Articular facet of lachrymal	large	→ small
2. Lateral flange on lachrymal	absent	→ present
3. Attachment between lachrymal and nasal	absent	→ present → present with rostral plate
4. First infraorbital shelf	absent	→ present anteriorly → present posteriorly
5. Relationship between fifth and second infraorbitals	separate	→ attach
6. Cheek cover by infraorbitals	incomplete	→ complete
7. Ascending process of premaxillary	short	→ long
8. Position of mouth	terminal	→ inferior → superior
9. Attachment between entopterygoid and metapterygoid	present	→ absent
10. Attachment between entopterygoid and quadrate	present	→ absent
11. Ectopterygoid	large	→ small → absent
12. Interhyal	short	→ long
13. Branchiostegal rays	six	→ five
14. Ventral keel of urohyal	absent	→ present
15a. Second basibranchial	present	→ absent
15b. Third basibranchial	present	→ absent
16. Basihyal	present	→ absent
17. Rostral plate	absent	→ tiny → enlarged
18. Spine on rostral plate	absent	→ one → three
19. Attachment between nasals	absent	→ present → secondarily absent
20. Anterior free nasal margin	smooth	→ serrated → with a spine
21. Forward projection of nasal	absent	→ present
22. Attachment between prevomer and ethmoid	absent	→ present
23. Ethmoidal spine	absent	→ two → one
24. Anterior process on ethmoid	small	→ large
25. Articular facet of prefrontal	posterior	→ anterior
26. Attachment between frontal and parasphenoid	absent	→ present
27. Dorsal margin of orbit	concave	→ convex
28. Exposed exoccipital	absent	→ present

29. Bridge of trigeminal facialis chamber	present	→ absent
30. Actinosts of pectoral girdle	four	→ three
31. Pores between actinosts	present	→ absent
32. Tabular bone	one	→ absent
33. Postcleithrum	two	→ one
34. Postpelvic spine	absent	→ present
35. Inner pelvic keel	absent	→ present
36. Pleural ribs	present	→ absent
37. Insertion of first dorsal pterygiophores	anterior	→ posterior
38. Spines on dorsal pterygiophore	two	→ one → absent
39. Spinous dorsal pterygiophores	continuous	→ discontinuous
40. Interdorsal pterygiophores	continuous	→ discontinuous
41. Insertion of first anal pterygiophore	anterior	→ posterior
42. Epurals	two	→ one

Distribution of the above character conditions in agonid fishes is summarized in Fig. 94.

3. Interrelationships of agonid genera and species

In this section, branching patterns of the agonid fishes are reconstructed (Fig. 95), based on the 42 characters analyzed above (Fig. 94).

The family Agonidae can be divided into two main stems-A1 and A2, and three main substems-B1, B2 and B3 (Fig. 96).

Stem A1 (Figs. 96 and 97)

Stem A1 is characterized by three synapomorphies, absence of the basihyal (16), convex dorsal margin of the orbit (27), and discontinuous proximal pterygiophores of the spinous dorsal fin (39). This stem is the first derivative from the common ancestor of the family Agonidae, and is composed of two substems, *Hypsagonus*-substem and *Percis*-substem.

The *Hypsagonus*-substem is defined by two synapomorphies, long ascending process of the premaxillary (7) and long interhyal (12), and contains five species, *H. mozinoi*, *H. quadricornis*, *H. corniger*, *H. proboscidalis* and *H. jordani*. Firstly, *H. mozinoi* is derived from the common ancestor of this substem. *H. quadricornis* and *H. corniger* are the sister group of *H. proboscidalis* and *H. jordani*, the common ancestor of this substem having the shared derived character, an anterior attachment between the nasals (19). The common ancestor of *H. proboscidalis* and *H. jordani* is characterized by an attachment between the second and fifth infraorbitals (5) and a junction between the frontal and the parasphenoid (26). *H. jordani* possesses the most derived conditions in the *Hypsagonus*-substem, and is defined by the absence of the bridge of the trigeminal facialis chamber (29).

The *Percis*-substem consists of two species, *P. japonicus* and *P. matsuii*. The common ancestor of this substem is characterized by five derived characters, attach-

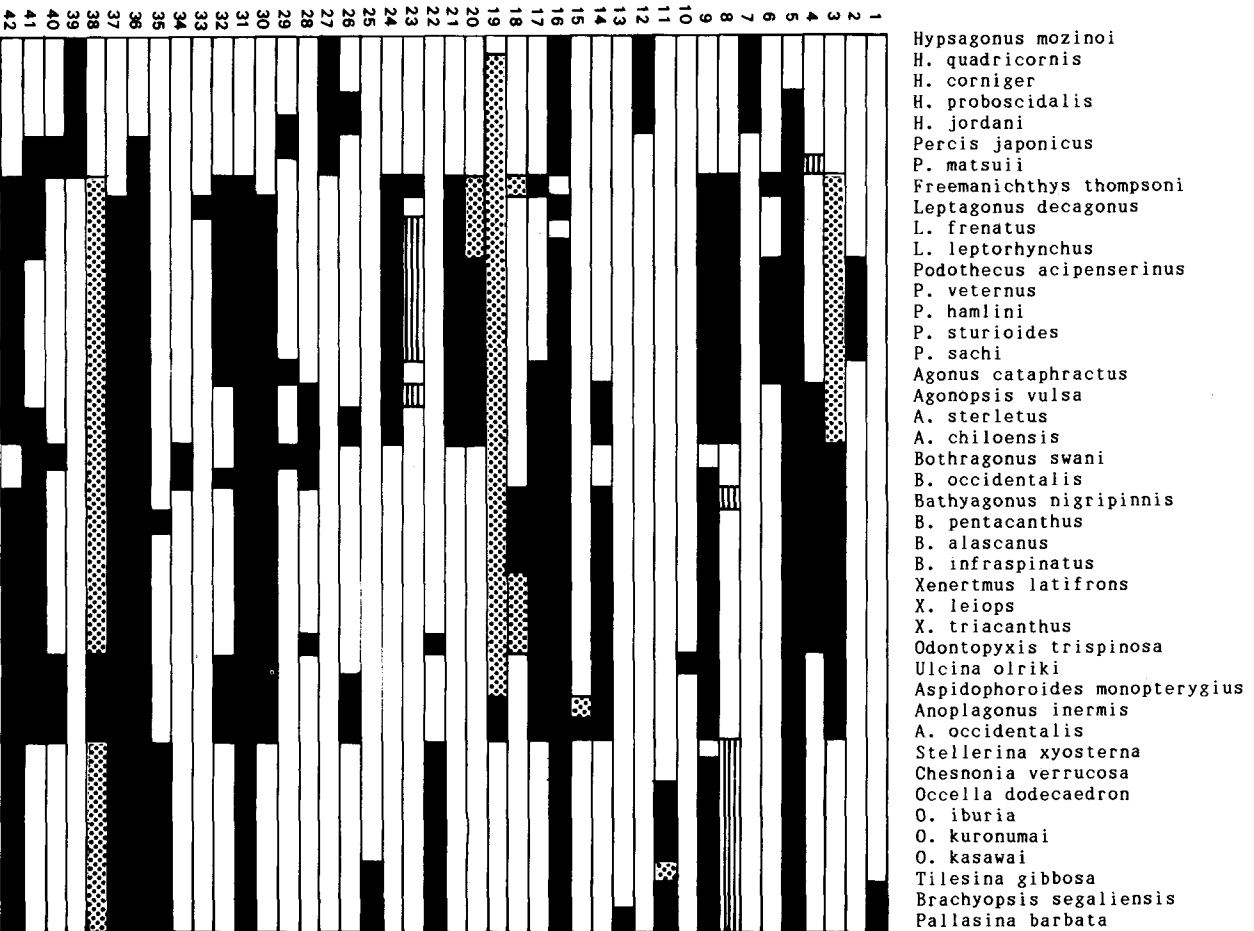

Fig. 94. Character conditions of 43 species in the family Agonidae. Solid, shaded and dotted squares indicate the derived condition. The open square indicates the primitive condition. For explanation of numerals, see text.

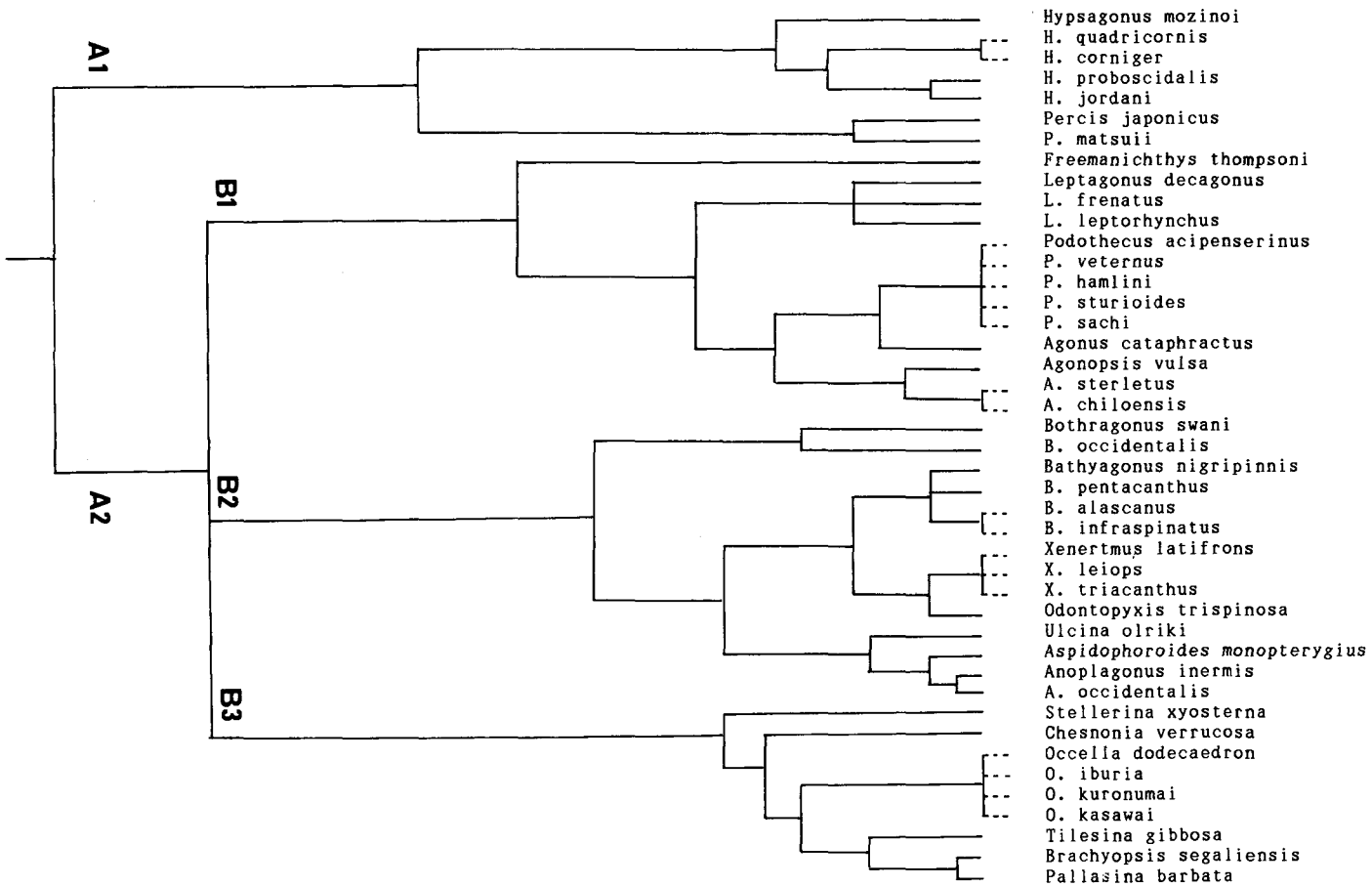

Fig. 95. Hypothetical branching pattern of 43 species in the family Agonidae.

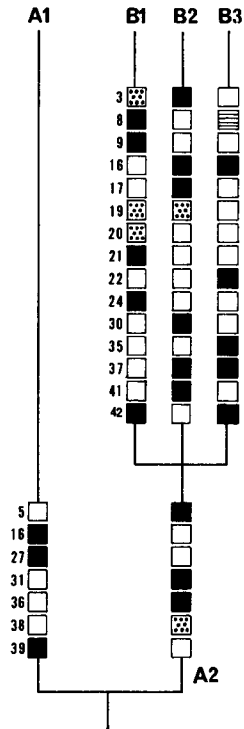

Fig. 96. Hypothetical branching pattern of stems A1 and A2, and substems B1, B2 and B3.

ment between the second and fifth infraorbitals (5), anterior attachment between the nasals (19), absence of pleural ribs (36) absence of interdorsal pterygiophores (40), and posterior insertion of the first anal pterygiophore (41).

Stem A2 (Fig. 96)

Stem A2 is characterized by four synapomorphies, attachment between the second and fifth infraorbitals (5), no pores between the actinosts (31), no pleural ribs (36), and one spine on the first dorsal pterygiophore (38). This stem is divided into three substems B1, B2 and B3.

Substem B1 (Figs. 96 and 98)

Substem B1 is characterized in having eight derived characters, attachment between the lachrymal and nasal (3), inferior mouth (8), absence of the entopterygoid-metapterygoid junction (9), anterior attachment between the nasals (19), serrated free nasal margin (20), forward projection of the nasal (21), large anterior process on ethmoid (24), and one epural (42). This substem includes the substems-*Freemanichthys*, *Leptagonus*, *Podothecus*, *Agonus*, and *Agonopsis*.

The *Freemanichthys*-substem, represented by the monotypic species, *F. thomp-*

contains three species, *L. decagonus*, *L. frenatus* and *L. leptorhynchus*. The branching pattern of these species is treated as a trichotomy, with the following derived characters; presence or absence of basihyal (16); two or no ethmoidal spines (23); one or two postcleithra (33).

At branching point "c," the *Podothecus-Agonus*-substem and the *Agonopsis*-substem are differentiated. The common ancestor of this substem is characterized by absence of a basihyal (16), and anterior free nasal margin with a spine (20).

The common ancestor of the *Podothecus-Agonus*-substem has two derived characters, complete cheek cover by infraorbitals (6), and absence of the tabular bone (32). The *Podothecus*-substem is defined by presence of a lateral flange on the lachrymal (2) and two ethmoidal spines (23), contains five species, *P. acipenserinus*, *P. veterinus*, *P. hamlini*, *P. sturioides* and *P. sachi*. The *Agonus*-substem is characterized by a rostral plate (17) and absence of the bridge of the trigeminal facialis chamber (29).

The ancestor of the *Agonopsis*-substem possesses the first infraorbital shelf (4), ventral keel of an urohyal (14), a rostral plate (17), and exposed exoccipital (28). From this ancestor, *Agonopsis vulsa* and the sister species, *A. sterletus* and *A. chiloensis*, evolved.

Substem B2 (Figs. 96 and 99)

Substem B2 is characterized by the following derived characters; attachment between the lachrymal and nasal (3); absence of the basihyal (16); enlarged rostral plate (17); attachment between the nasals (19); three actinosts (30); posterior insertion of the dorsal pterygiophores (37); and posterior insertion of the first anal pterygiophore (41). This substem is composed of six genera, *Bothragonus*, *Bathyagonus*, *Xenertmus*, *Odontopyxis*, *Ulcina*, *Aspidophoroides*, and *Anoplagonus*.

At branching point "a," the *Bothragonus*-substem is characterized by the first infraorbital shelf (4), exposed exoccipital (28), and a postpelvic spine (34). The ancestor of the genus *Bothragonus* is divided into *B. swani* and *B. occidentalis*, based on character conditions of the following, attachment between the entopterygoid and metapterygoid (9), bridge of the trigeminal facialis chamber (29), number of tabular bones (32), and insertion of interdorsal pterygiophores (40).

The other substem at branching point "a" is characterized in having three derived conditions, absence of the attachment between the entopterygoid and metapterygoid (9), ventral keel on the urohyal (14), and one epural (42). At branching point "b," this common ancestor is divided into two substems, the *Bathyagonus-Xenertmus-Odontopyxis*-substem and the *Ulcina-Aspidophoroides-Anoplagonus*-substem. The common ancestor of the former substem is characterized by derived conditions of the first infraorbital shelf (4) and a single spine on the rostral plate (18). The ancestor of the latter substem is characterized by the absence of the tabular bone (32), one spine on the dorsal pterygiophore (38), and discontinuous interdorsal pterygiophores (40).

The *Bathyagonus*-substem deviates from the *Xenertmus-Odontopyxis*-substem at branching point "c," and is defined by a single derived character, three spines on the rostral plate (18). This substem comprises four species, *B. nigripinnis*, *B. pentacanthus*, *B. alascanus* and *B. infraspinatus*.

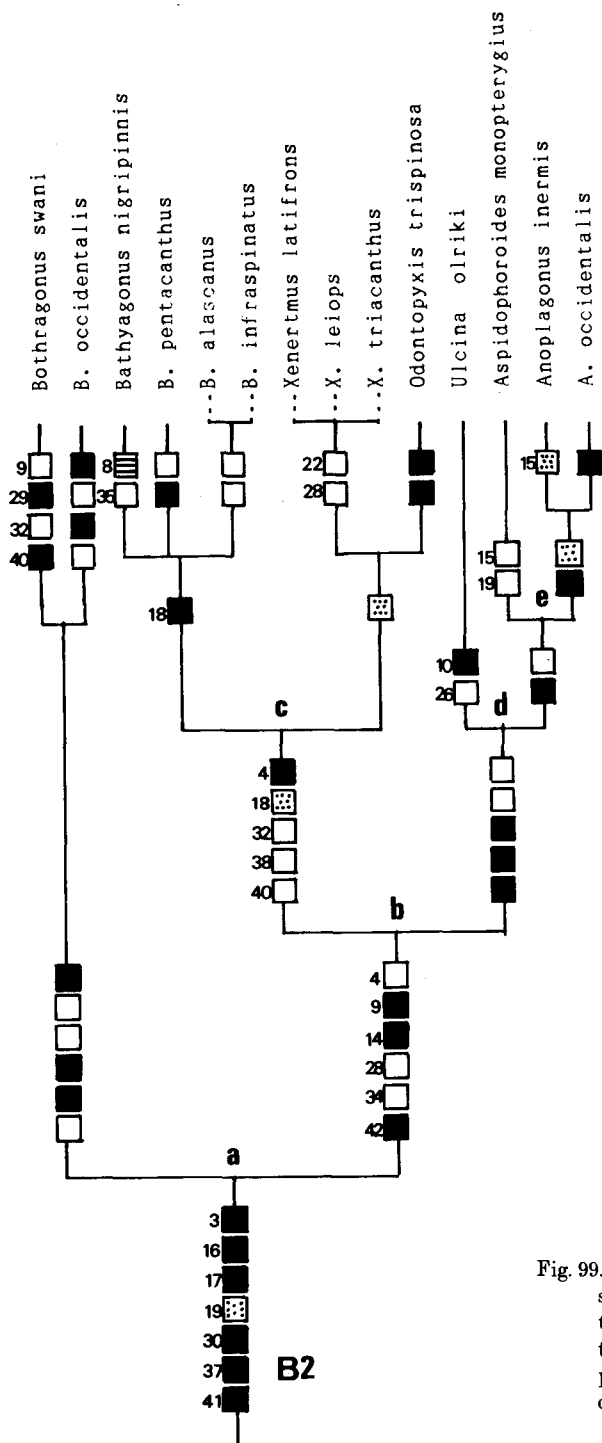

Fig. 99. Hypothetical branching pattern of substem B2. Solid, shaded and dotted squares indicate the derived condition. The open square indicates the primitive condition. For explanation of numerals, see text.

The *Xenertmus-Odontopyxis*-substem has a single derived condition, one spine on the rostral plate (18), and further branches into two substems. The *Odontopyxis*-substem is separated from the *Xenertmus*-substem by two derived characters, attachment between the prevomer and ethmoid (22) and an exposed exoccipital (28), and is represented by a single species, *O. trispinosa*. The *Xenertmus*-substem has no further apomorphies.

In the *Ulcina-Aspidophoroides-Anoplagonus*-substem, the *Ulcina*-substem is characterized by a single derived character, absence of an attachment between the entopterygoid and quadrate (10). This substem is composed of the monotypic species, *U. olriki*.

At the branching point "e," the *Aspidophoroides*-substem and *Anoplagonus*-substem are divided from the common ancestor with a single derived character, an attachment between the frontal and parasphenoid (26). The *Anoplagonus*-substem is subdivided into *A. inermis* and *A. occidentalis* by a single derived character, number of basibranchials (15). The *Aspidophoroides*-substem contains a monotypic species, *A. monopterygius*, and has no further apomorphies.

Substem B3 (Figs. 96 and 100)

The common ancestor of substem B3 is characterized by the following derived conditions: superior mouth (8); absence of the basihyal (16); attachment between the prevomer and ethmoid (22); an inner pelvic keel (35); posterior insertion of the first dorsal pterygiophore (37); and one epural (42). This main substem includes six substems—*Stellerina*, *Chesnonia*, *Ocella*, *Tilesina*, *Brachyopsis* and *Pallasina*.

From the common ancestor of substem B3, two substems, *Chesnonia-Ocella-Tilesina-Brachyopsis-Pallasina*-substem and *Stellerina*-substem, deviate at branching point "a." The former substem has a single derived condition, absence of an attachment between the entopterygoid and metapterygoid (9). The latter substem composed of a single species, *S. xyosterna*, has no further apomorphies.

At branching point "b," the *Ocella-Tilesina-Brachyopsis-Pallasina*-substem and *Chesnonia*-substem are branched. The former substem is characterized by a single synapomorphy, a small or absent ectopterygoid (11). The latter substem, including only *C. verrucosa*, has no further apomorphies. The *Ocella* and *Tilesina-Brachyopsis-Pallasina*-substems, at branching point "c," are separated by two synapomorphies, absence of the ectopterygoid (11) in the former, and anterior position of the prefrontal articular facet (25) in the latter.

The *Ocella*-substem includes four species, *O. dodecaedron*, *O. iburia*, *O. kuronumai* and *O. kasawai*.

In the *Tilesina-Brachyopsis-Pallasina*-substem, the common ancestor is characterized by a small ectopterygoid (11) and anterior position of the prefrontal articular facet (25). At the branching point "d," *Tilesina*-substem is deviated from the ancestor, and defined by a small ectopterygoid. This substem consists of a single species, *T. gibbosa*.

The *Brachyopsis-Pallasina*-substem has two derived characters, a small articular facet of the lachrymal (1) and absence of the ectopterygoid (11). It can be further subdivided on the basis of number of branchiostegal rays (13). The *Pallasina*-substem is defined by a single derived character, five branchiostegal rays,

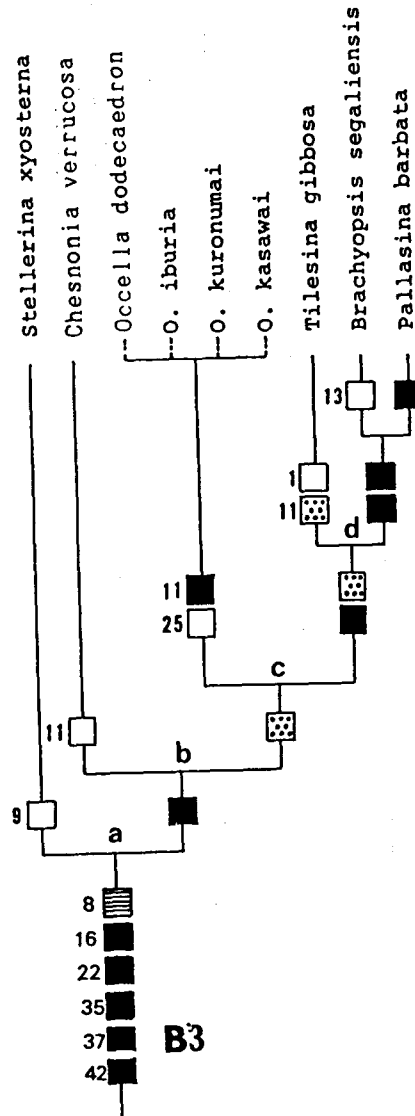

Fig. 100. Hypothetical branching pattern of substem B3. Solid, shaded and dotted squares indicate the derived condition. The open square indicates the primitive condition. For explanation of numerals, see text.

and is represented by *P. barbata*. The *Brachyopsis*-stem similarly includes a single species, *B. segaliensis*.

4. General consideration

In this study, based on osteological comparisons, a phylogenetic analysis of the

Agonidae was made. On the basis of the cladogram obtained, the monophyletic family Agonidae is composed of two stems (A1 and A2) and three substems (B1, B2 and B3). At the first branch, the common ancestor of the agonids was divided into stems A1 and A2. Stem A1 contained substems-*Hypsagonus* and *Percis*. Stem A2 was subdivided into substems B1, B2 and B3. Substem B1 comprised substems-*Freemanichthys*, *Leptagonus*, *Podothecus*, *Agonus* and *Agonopsis*. Substem B2 was composed of substems-*Bothragonus*, *Bathyagonus*, *Xenertmus*, *Odontopyxis*, *Ulcina*, *Aspidophoroides* and *Anoplagonus*. Substem B3 comprised substems-*Stellerina*, *Chesnonia*, *Ocella*, *Tilesina*, *Brachyopsis* and *Pallasina*.

In the past, a number of subfamilial groupings have been proposed (Gill, 1862d; Jordan and Evermann, 1898; Jordan and Starks, 1904; Freeman, 1951a; Matsubara, 1955; Lindberg, 1971; Nelson, 1976; Lindberg and Krasnyukova, 1987; Leipertz, 1988). Gill (1862d) recognized two subfamilies, Agoninae and Anoplagoninae, whereas Jordan and Evermann (1898) proposed four subfamilies, Percidinae, Brachyopsinae, Agoninae and Aspidophoroidinae. Jordan and Starks (1904) added the subfamily Tilesininae to the four subfamilies of Jordan and Evermann (1898). Matsubara (1955) elevated Aspidophoroidinae to the family Aspidophoridae. In his unpublished dissertation, Freeman (1951a) proposed four subfamilies, Percidinae, Xenertminae (=Anoplagoninae of Gill, 1862d), Brachyopsinae and Agoninae, based on a comparison of external characters. Leipertz (1985, 1988) later recognized Freeman's subfamilies on the basis of external and a few osteological features. However, previously Lindberg (1971) had proposed the subfamilies Bathyagoninae and Bothragoninae, in addition to the four subfamilies of Jordan and Evermann, 1898. For comparison of the cladogram obtained from the present study with the above subfamilies, each of stems-A1 and A2 is ranked as groups I and II. Substems-B1, B2 and B3 agree well with the ranking of agonid subfamilies by Leipertz (1988). However, the subfamily Xenertminae is preoccupied by the Anoplagoninae of Gill (1862d). Therefore, the ranking of these substems in the present study is considered as follows: substem B1, Agoninae; substem B2, Anoplagoninae; substem B3, Brachyopsinae. Furthermore, to minimize taxonomic confusion, stem A1 is ranked as the subfamily Percidinae. Thus, the validity of four subfamilies, Percidinae, Agoninae, Anoplagoninae (=Xenertminae of Leipertz, 1988) and Brachyopsinae, is confirmed from the cladogram, based on 42 shared, derived osteological characters.

In this study, the subfamily Percidinae is defined on the basis of three derived characters, viz., absence of the basihyal, convex dorsal margin of the orbit and discontinuous pterygiophores of the spinous dorsal fin, and consists of *Hypsagonus* and *Percis*. This subfamily has long been considered to be valid (Jordan and Evermann, 1898; Freeman, 1951a; Matsubara, 1955; Leipertz, 1988), and is here confirmed to be the most primitive assemblage in the family Agonidae.

Hypsagonus is a monophyletic group defined by two derived characters, a long ascending process of the premaxillary and a long interhyal, and includes five species, *H. mozinoi*, *H. quadricornis*, *H. corniger*, *H. proboscidalis* and *H. jordani*. In this lineage, two genera, *Hypsagonus* and *Agonomalus*, have been previously recognized (Guichenot, 1866; Jordan and Evermann, 1898; Soldatov and Lindberg, 1930; Matsubara, 1955; Wilimovsky and Wilson, 1978). The former contains *H. qua-*

dricornis and *H. corniger*, and the latter consists of other three species. The cladogram clearly shows *H. mozinoi* to separate from the common ancestor of this lineage at the first step (Fig. 97). At the second step, groups comprising *H. quadricornis* and *H. corniger*, and *H. proboscidalis* and *H. jordani* diverge. Thus, the former grouping of the genus *Agonomalus* is considered to be polyphyletic, and *Agonomalus* is hereby relegated to the synonymy of *Hypsagonus*.

In *Hypsagonus*, the two synapomorphies, long ascending process of the premaxillary and long interhyal, represent an important evolutionary trend. As a characteristics of fish evolution, improvements of the mouth structure are well known (Schaeffer and Rosen, 1961; Alexander, 1967; Gosline, 1972). The expansion of the mouth cavity is considered to be an adaptation for effective feeding in benthic waters. In *Hypsagonus*, such expansion is achieved by the long ascending process of the premaxillary and the long interhyal, and appears to enable stronger suction.

Percis, the sister group of *Hypsagonus*, consists of *P. japonicus* and *P. matsuii*. *P. matsuii* is characterized by the derived character, a shelf on the first infraorbital. This appears to play a roll in the lower support of a large eyeball, as Matsubara (1943) discussed for scorpaenids. The large eyeball and shelf of *P. matsuii* are considered to be adaptations to deep water, because fishes with a large eyeball, consistently live in deep water, for example, fishes in the genera *Xenertmus*, *Bathyagonus*, *Hozukius*, *Adelosebastes*, and others.

The subfamily Agoninae as established by Jordan and Evermann (1989), comprised *Leptagonus*, *Podothecus*, *Agonus*, *Agonopsis*, *Bathyagonus*, *Xenertmus*, *Odontopyxis*, and *Bothragonus*. Matsubara (1955) followed Jordan and Evermann (1989). Freeman (1951a) and Leipertz (1988), however, considered that Agoninae were composed of *Leptagonus* (including *Sarritor*), *Podothecus*, *Agonus*, and *Agonopsis*. Thus, the composition of this subfamily has been variable. In the present study, *Freemanichthys*, *Leptagonus*, *Podothecus*, *Agonus* and *Agonopsis* are shown to reasonably constitute the subfamily Agoninae, and are considered to be a monophyletic group.

In the cladogram of the subfamily Agoninae, the common ancestor of the subfamily divides into two substems, the Freemanichthys-substem and the remainder of the subfamily. Formerly, *F. thompsoni* had been included *Podothecus* (Jordan and Gilbert, 1898; Jordan et al., 1913; Soldatov and Lindberg, 1930; Taranetz, 1937; Matsubara, 1955; Ilina, 1978). According to the cladogram, *F. thompsoni* is far from the species of *Podothecus*, which is, in fact, the sister group of *Agonus*. Therefore, it is clearly appropriate to establish a new genus, *Freemanichthys*.

At the second branch of substem B1, the genus *Leptagonus* deviates, being supported by two derived characters, absence of the tabular bone and the posterior insertion of the first pterygiophore of the anal fin. Previously two genera, *Leptagonus* and *Sarritor*, had been recognized (Jordan and Evermann, 1898; Soldatov and Lindberg, 1930; Matsubara, 1955; Eschmeyer et al., 1983). *Leptagonus* has contained *L. decagonus*. *Sarritor* has been represented by *L. frenatus* and *L. leptorhynchus*. The character analysis reveals that these three species trichotomously occur from the common ancestor. Therefore, *Sarritor* is considered to be a synonym of *Leptagonus*.

In this lineage, an inferior mouth and supporting structures seem to be a feeding adaptation for obtaining benthic food. Concerning feeding adaptations in agonid fishes, there have been three main evolutionary developments. The first is the expansion of the gill cavity, as discussed in Percidinae. The second is the achievement of an inferior mouth, as observed in Agoninae. The third is the improvement of a superior mouth, as in Brachyopsinae. With regard to the inferior mouth in Agoninae, *Podothecus* is characterized by the most advanced condition, having the lower jaw never reaching the upper one, a lateral flange on the lachrymal, and a complete cheek cover. The most primitive condition of the mouth structure was observed in *Leptagonus* and *Agonopsis*, and is represented by having the jaws attached to one another, no lateral flange on the lachrymal, and an incomplete cheek cover. *Freemanichthys* and *Agonus* show an intermediate condition in mouth development. Progressive evolution of the mouth structure could be seen along two lines, viz. common ancestor-*Freemanichthys*, and common ancestor-*Leptagonus*-*Agonopsis*-*Agonus*-*Podothecus*.

The subfamily Anoplagoninae is a monophyletic assemblage defined by seven derived characters, and includes seven genera, *Bothragonus*, *Bathyagonus*, *Xenertmus*, *Odontopyxis*, *Ulcina*, *Aspidophoroides* and *Anoplagonus*, according to the present study.

Freeman (1951a) recognized the subfamily Xenertminae (= Anoplagoninae), composed of *Bothragonus*, *Bathyagonus* (including *Asterotheca*), *Xenertmus*, *Odontopyxis*, *Aspidophoroides* and *Anoplagonus*. He recognized two branches in this subfamily, on the basis of comparisons of external morphological characters, the *Bothragonus*-*Odontopyxis*-*Aspidophoroides*-*Anoplagonus* assemblage, and the *Xenertmus*-*Bathyagonus* assemblage. Leipertz (1985, 1988) reconstructed the relationships of the Xenertminae with related subfamilies by the Wagner analysis. He considered that the *Aspidophoroides*-*Anoplagonus* group was a sister group of *Bothragonus*, and that together, the two groups formed a sister group of *Odontopyxis*. In the present study, *Bothragonus* is considered to have deviated from the remaining genera in this subfamily at the first branching point, and is defined as a monophyletic group on the basis of three derived characters, presence of the first infraorbital shelf, exposed exoccipital and postpelvic spine.

At branching point "d" of substem B2 (Fig. 99), *Ulcina*-substem and *Aspidophoroides*-*Anoplagonus*-substem diverge. Up to now, *Ulcina* has been considered either as a synonym of *Aspidophoroides* (Vladykov, 1933; Backus, 1957; Leim and Scott, 1966; Gruchy, 1970), or as a valid genus (Andriashev 1937, 1954 and 1986; Taranetz, 1937; Okada and Kobayashi, 1968). In the present study, *Ulcina* is considered a valid genus, defined by the derived character, absence of an attachment between the entopterygoid and quadrate.

In the subfamily Anoplagoninae, evolutionary trends in feeding adaptations were not clear.

The subfamily Brachyopsinae is here characterized by six derived characters, and consists of *Stellerina*, *Chesnonia*, *Occella*, *Tilesina*, *Brachyopsis* and *Pallasina*. The subfamily Brachyopsinae was considered to consist of *Stellerina*, *Occella*, *Brachyopsis* and *Pallasina*, by Jordan and Starks (1904) and Matsubara (1955). Jordan and Starks elevated *Tilesina* to the subfamily Tilesininae, on the basis of its

numerous dorsal spines (17-21) and anal rays (23-27). Freeman (1951a), however, comprised *Tilesina* in Brachyopsinae, and was followed by Leipertz (1988). The present classification of Brachyopsinae, is consistent with Freeman's view. In his phylogenetic analysis of the subfamily, Freeman (1951a) presented two branches, the *Stellerina-Ocella* group and the *Tilesina-Brachyopsis-Pallasina* group. The present study reveals that branching in the subfamily gave in sequence, *Stellerina*, *Chesnonia*, *Ocella*, *Tilesina*, *Brachyopsis* and *Pallasina*. These are considered to have generic ranking, because the sister groups have equal rank.

At branching point "b" of stem B3 (Fig. 100), the *Chesnonia* and *Ocella-Tilesina-Brachyopsis-Pallasina*-substems diverge. Formerly, *C. verrucosa* had been included in the genus *Ocella* (Gruchy, 1970; Hart, 1973; Eschmeyer et al., 1983). According to the cladogram obtained, *C. verrucosa* is well separated from *Ocella*, and is therefore judged to be valid.

In the subfamily Brachyopsinae, an improvement in the structure of the superior mouth was observed. *Pallasina* and *Brachyopsis* had the most advanced structure, characterized by the absence of the ectopterygoid, and of any attachment between the entopterygoid and metapterygoid. *Stellerina* revealed the most primitive structure, represented by the ectopterygoid and an attachment between the entopterygoid and metapterygoid. *Tilesina* and *Ocella* showed an intermediate condition. In fact, progressive evolution of the mouth, i.e. elongation of the mouth cavity, could be seen in the lineage *Stellerina-Chesnonia-Ocella-Tilesina-Brachyopsis-Pallasina*, and conformed to the cladogram presented.

As a result, a new classification of the family Agonidae has been constructed, as shown below. The asterisked species were not examined in the present study.

Family Agonidae Swainson, 1839

Group I

Subfamily Percidinae Jordan et Evermann, 1898

Genus *Hypsagonus* Gill, 1862

H. mozinoi (Wilimovsky et Wilson, 1978)

H. quadricornis (Cuvier, 1829)

H. corniger Taranetz, 1933

H. proboscidalis (Valenciennes, 1858)

H. jordani (Schmidt, 1904)

Genus *Percis* Scopoli, 1777

P. japonicus (Pallas, 1772)

P. matsuii Matsubara, 1936

Group II

Subfamily Agoninae Gill, 1862

Genus *Freemanichthys* gen. nov.

F. thompsoni (Jordan et Gilbert, 1898)

Genus *Leptagonus* Gill, 1862

L. decagonus (Schneider, 1801)

L. frenatus (Gilbert, 1896)

L. leptorhynchus (Gilbert, 1896)

- Genus *Podothecus* Gill, 1862
P. acipenserinus (Tilesius, 1813)
P. veterinus Jordan et Starks, 1895
P. hamlini Jordan et Gilbert, 1898
P. sturioides (Guichenot, 1869)
P. sachi (Jordan et Snyder, 1901)
- Genus *Agonus* Bloch et Schneider, 1801
A. cataphractus (Linnaeus, 1758)
- Genus *Agonopsis* Gill, 1862
A. vulsa (Jordan et Gilbert, 1881)
A. sterletus (Gilbert, 1898)
A. chiloensis (Jenyns, 1842)
- Subfamily Anoplagoninae Gill, 1862
- Genus *Bothragonus* Gill, 1881
B. swani (Steindachner, 1877)
B. occidentalis Lindberg, 1935
- Genus *Bathyagonus* Gilbert, 1890
B. nigripinnis (Gilbert, 1890)
B. pentacanthus (Gilbert, 1890)
B. alascanus (Gilbert, 1896)
B. infraspinatus (Gilbert, 1904)
- Genus *Xenertmus* Gilbert, 1903
X. triacanthus (Gilbert, 1890)
X. latifrons (Gilbert, 1890)
X. leiops Gilbert, 1915
*X. ritteri** Gilbert, 1915
- Genus *Odontopyxis* Lockington, 1879
O. trispinosa Lockington, 1880
- Genus *Ulcina* Cramer, 1896
U. olriki (Lütken, 1876)
- Genus *Aspidophoroides* Lacépède, 1802
A. monopterygius (Bloch, 1787)
- Genus *Anoplagonus* Gill, 1862
A. inermis (Günther, 1860)
A. occidentalis Lindberg, 1950
- Subfamily Brachyopsinae Jordan et Evermann, 1898
- Genus *Stellerina* Cramer, 1896
S. xyosterna (Jordan et Gilbert, 1881)
- Genus *Chesnomia* Iredale et Whitley, 1969
C. verrucosa (Lockington, 1880)
- Genus *Ocella* Jordan et Hubbs, 1925
O. dodecaedron (Tilesius, 1813)
O. iburia (Jordan et Starks, 1904)
O. kuronumai (Freeman, 1951)
O. kasawai (Jordan et Hubbs, 1925)
*O. impi** Gruchy, 1970

- Genus *Tilesina* Schmidt, 1904
T. gibbosa Schmidt, 1904
- Genus *Brachyopsis* Gill, 1862
B. segaliensis (Tilesius, 1809)
- Genus *Pallasina* Cramer, 1895
P. barbata (Steindachner, 1877)

VIII. summary

The present study was intended to clarify the phylogeny of the family Agonidae, and to establish a taxonomy of agonid fishes, based on phylogenetic analysis. Specimens of 43 agonid species, excluding *Xenertmus ritteri* and *Ocella impi*, were used for the study. For comparative morphology, the following 12 skeletal parts for each species were examined: circumorbital bones; jaws; suspensorium and opercular apparatus; hyoid apparatus; branchial apparatus; cranium; pectoral girdle; pelvic girdle; vertebrae and pterygiophores; caudal skeleton. 42 characters were selected and used for reconstruction of relationships.

For the analysis of phylogenetic relationships, the cladistic approach was used. The sharing of derived characters was used to connect related groups, without using the principle of parsimony (Nelson, 1970). The polarity of each character was determined by examination of the character throughout both agonids and related groups.

The conclusions of the study are summarized as follows.

1. Taxonomy of the family Agonidae

- (1) The family Agonidae comprises 45 species, 20 genera, and 4 subfamilies.
- (2) The subfamily Percidinae comprises two genera, *Hypsagonus* (5 species) and *Percis* (2 species).
- (3) *Agonomalus* is regarded as a synonym of *Hypsagonus*. *Hypsagonus* includes 5 species; *H. mozinoi*, *H. quadricornis*, *H. corniger*, *H. proboscidalis*, and *H. jordani*.
- (4) The subfamily Agoninae is composed of 5 genera; *Freemanichthys* (1 species), *Leptagonus* (3 species), *Podothecus* (5 species), *Agonus* (1 species), and *Agonopsis* (3 species).
- (5) A new genus, *Freemanichthys*, is established on the basis of the following diagnostic characters; a rostral plate present on the ventral surface of the snout, a forwardly projecting nasal with a serrated free margin, a pair of barbel patches on the ventral surface of the snout, a single ethmoidal spine, and others.
- (6) *Sarritor* is considered to be a synonym of *Leptagonus*. *Leptagonus* comprises 3 species; *L. decagonus*, *L. frenatus*, and *L. leptorhynchus*.
- (7) *Podothecus gilberti* and *P. accipiter* are regarded as synonyms of *P. sturionoides*.
- (8) The subfamily Anoplagoninae consists of 7 genera; *Bothragonus* (2 species), *Bathyagonus* (4 species), *Xenertmus* (4 species), *Odontopyxis* (1 species), *Ulcina* (1 species), *Aspidophoroides* (1 species), and *Anoplagonus* (1 species).
- (9) *Aspidophoroides bartoni* is considered to be a synonym of *A. monoapter-*

ygius.

(10) The subfamily Branchyopsinae is composed of 6 genera; *Stellerina* (1 species), *Chesnonia* (1 species), *Ocella* (5 species), *Tilesina* (1 species), *Brachyopsis* (1 species), and *Pallasina* (1 species).

(11) *Chesnonia* is considered to be valid, and is distinguished from *Ocella*.

(12) *Tilesina hubbsi* is regarded as a synonym of *T. gibbosa*.

(13) *Brachyopsis rostratus* (= *rostrata*) is considered to be a synonym of *B. segaliensis*.

(14) *Pallasina eryngia* and *P. aix* are regarded as synonyms of *P. barbata*.

2. Phylogeny of the family Agonidae

(1) The monophyly of the family Agonidae is supported by the combination of 16 synapomorphies; three infraorbitals, six or fewer branchiostegal rays, presence or absence of a tiny basihyal, one upper pharyngeal, no tooth plate on the third epibranchial, one or no tabular bones, plate-like actinosts on the pectoral girdle, one spine and two pelvic fin rays, the first dorsal proximal pterygiophore inserted into the second or more posterior interneural space, four or fewer pleural ribs, no anal spine, Baudelot's ligament attached to the first centrum, completely fused hypural complex, unbranched fin rays, bony plates covering the body, and absence of a swim bladder.

(2) The monophyly of the subfamily Percidinae is supported by two synapomorphies; convex dorsal margin of the orbit, and discontinuous pterygiophores supporting the spinous dorsal fin. This subfamily is considered to be the most primitive assemblage in the family Agonidae. The lineage in *Hypsagonus* is regarded as the *mozinoi-quadricornis-jordani* line.

(3) The monophyly of the subfamily Agoninae is supported by 12 synapomorphies; presence of an attachment between the lachrymal and nasal, fifth infraorbital attached to the second, inferior mouth, absence of an attachment between the entopterygoid and metapterygoid, nasals attached to each other, spinous or serrated anterior free nasal margin, forwardly projecting nasal, large anterior process of the ethmoid, no pores between actinosts, no pleural ribs, and one spine on the first dorsal pterygiophore. *Freemanichthys* is the first derivative from the common ancestor of this subfamily. The lineage in Agoninae is considered to be the *Freemanichthys-Leptagonus-Podothecus-Agonus-Agonopsis* line.

(4) The monophyly of the subfamily Anoplagoninae is supported by 11 synapomorphies; presence of an attachment between the nasal, rostral plate and lachrymal, fifth infraorbital attached to second, no basihyal, enlarged rostral plate, nasals attached to each other, three actinosts on pectoral girdle, no pores between actinosts, no pleural ribs, posterior insertion of the first dorsal pterygiophore, one or no spines on first dorsal pterygiophore, and posterior insertion of the first anal pterygiophore. *Bothragonus* is regarded as the first derivative from the common ancestor of this subfamily. The lineage in Anoplagoninae is considered to be represented two lines, the *Bothragonus-Ulcina-Aspidophoroides-Anoplagonus* line and the *Bothragonus-Bathyagonus* line, including *Xenertmus* and *Odontopyxis*.

(5) The monophyly of the subfamily Brachyopsinae is supported by 9 synapomorphies; fifth infraorbital attached to second, superior mouth, no basihyal,

attachment between the prevomer and ethmoid, no pores between actinosts, presence of an inner pelvic keel, no pleural ribs, posterior insertion of the first dorsal pterygiophore, and one spine on the first dorsal pterygiophore. The lineage in Brachyopsinae is considered to be the *Stellerina-Chesnonia-Ocella-Tilesina-Brachyopsis-Pallasina* line. *Stellerina* is regarded as the first derivative from the common ancestor.

IX. Literature cited

- Alexander, R.M. 1967. The functions and mechanisms of the protrusible upper jaws of some acanthopterygian fish. *J. Zool., Lond.*, **151**: 43-64, figs. 1-9.
- Allis, E.P., Jr. 1909. The cranial anatomy of the mail cheeked fishes. *Zoologica*, **22**: 1-219, pls. 1-5.
- Andriashev, A.P. 1937. A contribution to the knowledge of the fishes from the Bering and Chukchi Seas. *Issled. Morei, Leningrad*, **25**: 292-355. (Transl. by Lanz, L. with N.J. Wilimovsky, 1955, U.S. Fish Wildl. Serv., Spec. Sci. Rep. Fish., **145**: 1-81, figs. 1-27.)
- Andriashev, A.P. 1954. *FISHES OF THE NORTHERN SEAS OF THE U.S.S.R.* *Zool. Inst. USSR Acad. Sci.*, (53): 1-544, figs. 1-308.
- Andriashev, A.P. 1986. Agonidae. Pages 1265-1268 in Whitehead, P.J.P., M.L. Bauchot, J.C. Hureau, J. Nielsen, and E. Tortonese, ed. *Fishes of the Northeastern Atlantic and the Mediterranean*, UNESCO, 1015-1426 pp.
- Backus, R.H. 1957. The fishes of Labrador. *Bull. Amer. Mus. Nat. Hist.*, **113**(4): 273-337.
- Bean, T.H. 1882. A preliminary catalogue of the fishes of Alaska and adjacent waters. *Proc. U.S. Natn. Mus.*, **4**: 237-272.
- Bean, T.H. 1885. Description of a new species of *Aspidophoroides* (*A. güntheri*), from Alaska. *Proc. U.S. Natn. Mus.*, **8**(5): 74-75.
- Birdsong, R.S. 1975. The osteology of *Microgobius signatus* Poey (Pisces: Gobiidae), with comments on other gobiid fishes. *Bull. Florida State Mus., Biol. Sci.*, **19**(3): 135-187, figs. 1-14.
- Bloch, M.E. 1787. *Ichthyologie, ou histoire naturelle, générale et particuliere des poissons*. Berlin, vol. 5, 130 pp., 145-180 pls.
- Bloch, M.E. and J.G. Schneider. 1801. *M.E. Blochii Systema Ichthyologiae iconibus ex illustratum. Post obitum auctoris opus inchoatum absolvit, correxit, interpolavit J.G. Schneider, Saxo*. Berlin, 584 pp., 110 pls.
- Bonaparte, C.L. 1846. Catalogo metodico dei pesci europei. *Atti Soc. Ital. Sci. Nat., Napoli*: 1-97.
- Bonnaterre, J.P. 1788. *Ichthyologie. Tableau encyclopédique et méthodique des trois règnes de la nature*. Paris, lvi+215 pp., A-B+100 pls.
- Clemens, W.A. and G.V. Wilby. 1946. Fishes of the Pacific coast of Canada. *Bull. Fish. Res. Bd. Can.*, **68**: 1-368.
- Collett, R. 1894. On a new agonid fish (*Agonus gilberti*) from Kamtschatka. *Proc. Zool. Soc., London*, **45**: 670-675, pl. 45.
- Cramer, F. 1894. Description of a little known agonid fish, *Hippocephalus japonicus*. *Proc. Calif. Acad. Sci.*, ser. 2, **4**: 148-153.
- Cuvier, G. 1829. *Le règne animal distribué d'après son organisation, pour servir de base à l'histoire naturelle des animaux et d'introduction à l'anatomie comparée*. Nouvelle édition, Paris, **2**, 122-406 pp.
- Cuvier, G. and A. Valenciennes. 1829. *Histoire naturelle des poissons*. Paris, vol. 4, 518 pp.
- Day, F. 1881. *The fishes of Great Britain and Ireland*. London-Edinburgh, vol. 1, cxii+336 pp., 92 pls.
- Deslongchamps, J.A.E. 1853. Note sur une nouvelle espèce de poisson du genre *Aspidophore*. *Mem. Soc. Linn. de Normandie*, **9**: 167-173.
- Eschmeyer, W.N., E.S. Herald, and H. Hamman. 1983. *A field guide to Pacific coast fishes of North America*. Houghton Mifflin Company, Boston, xii+312 pp., 44 figs., 48 pls.
- Evermann, B.W. and E.L. Goldsborough. 1907. The fishes of Alaska. *Bull. U.S. Bur. Fish., Wash.*,

- 26: 219-360, figs. 1-288, pls. 14-42.
- Fabricius, O. 1780. *Fauna Groenlandica systematice sistens, animalia Groenlandiae occidentalis*. Copenhagen and Leipzig, 452 pp.,
- Fitch, J.E. 1966. The poacher *Asterotheca infraspinata* (Gilbert) added to California's marine fauna, and a key to Californian Agonidae (Pisces). *Calif. Fish and Game*, **52**: 121-124.
- Fitch, J.E. 1973. The taxonomic status of genus *Asterotheca* and clarification of the distribution of *Bathyagonus pentacanthus* (Pisces: Agonidae). *Copeia*, **1973**(4): 815-817, fig. 1.
- Fleming, J. 1828. *A history of British animals exhibiting the descriptive characters and systematical arrangements of the genera and species of quadrupeds, birds, reptiles, fishes, mollusca and radiata of the U.K.; including the indigenous, extirpated and extinct kinds, together with periodical and occasional visitants*. Edinburg-London, xxiii+565 pp.
- Freeman, H.W. 1951a. *Contribution to the evolution and classification of the fishes of the family Agonidae*. Ph. D. dissert., Stanford Univ., Stanford, California, 288 pp. (unpublished.)
- Freeman, H.W. 1951b. Two new agonid fishes from the Sea of Japan. *Stanford Ichthyol. Bull.*, **4**(1): 22-26, figs. 1-2.
- Gilbert, C.H. 1890. A preliminary report on the fishes collected by the Steamer Albatross on the Pacific coast of North America during the year 1889, with descriptions of twelve new genera and ninety-two new species. *Proc. U.S. Natn. Mus.*, **13**: 49-126.
- Gilbert, C.H. 1896. The ichthyological collections of the steamer 'Albatross' during the years 1890 and 1891. *Rep. U.S. Comm. Fish.*, **19**(6): 393-476, pls. 20-35.
- Gilbert, C.H. 1904. Notes on fishes from the Pacific coast of North America. *Proc. Calif. Acad. Sci.*, Ser. 3, **3**(9): 255-271, pls. 25-29.
- Gilbert, C.H. 1915. Fishes collected by the United States fisheries steamer "Albatross" in southern California in 1904. *Proc. U.S. Natn. Mus.*, **48**: 305-380, pls. 14-22.
- Gill, T.N. 1862a. Catalogue of the fishes of the eastern coast of North America from Greenland to Georgia. *Proc. Acad. Nat. Sci., Philad.*, **13**(suppl.): 1-63.
- Gill, T.N. 1862b. On several new generic types of fishes. *Proc. Acad. Nat. Sci., Philad.*, **13**: 77-78.
- Gill, T.N. 1862c. Notes on some genera of fishes of the western coast of North America. *Proc. Acad. Nat. Sci. Philad.*, **13**: 164-168.
- Gill, T.N. 1862d. On the genus *Podothecus*. *Proc. Acad. Nat. Sci. Philad.*, **13**: 258-261.
- Goode, G.B. and T.H. Bean. 1896(1895). Oceanic Ichthyology, a treatise on the deep-sea and pelagic fishes of the world. *Spec. Bull. U.S. Natn. Mus.*, (35): i-xxxv+1-553, pls. 1-123.
- Gosline, W.A. 1972(1967). *Functional morphology and classification of teleostean fishes*. Hawaii Univ. Press, Honolulu, ix+208 pp., 29 figs.
- Gregory, W.K. 1933. Fish skulls, a study of the evolution of natural mechanisms. *Trans. Amer. Philosophical Soc.*, **23**(2): 75-481, figs. 1-302.
- Griffith, E. 1834. *The class Pisces, arranged by the Baron Cuvier, with supplementary additions by Edward Griffith*. Charles Hamilton Smith, London, 680 pp., 62 pls.
- Gruchy, C.G. 1969. Canadian records of the warty poacher, *Occa verrucosa*, with notes on the standardization of plate terminology in Agonidae. *J. Fish. Res. Bd. Can.*, **26**(6): 1467-1472, fig. 1.
- Gruchy, C.G. 1970. *Ocella impi*, a new species of sea poacher from British Columbia with notes on related species (Agonidae, Pisces). *J. Fish. Res. Bd. Can.*, **27**(6): 1109-1114, fig. 1.
- Guichenot, M. 1866. Notice sur un nouveau genre de poissons de la famille des Cottoides, du Muséum de Paris. *Mem. Soc. Imperiale Nat. Cerbourg*, **12**: 253-256.
- Guichenot, M. 1869. Notice sur quelque poissons inédite de Madagascar et de la Chine. *Nouv. Arch. Mus. Hist. Nat. Paris*, **5**: 193-206, pl. 12.
- Günther, A. 1860. *Catalogue of the fishes in the British Museum. II*. Brit. Mus. Natl. Hist., London, xxi+548 pp.
- Hart, J.L. 1973. Pacific fishes of Canada. *Bull. Fish. Res. Bd. Can.*, **180**: iv-ix+1-740, pls. 1-8.
- Hecht, M.K. and J.L. Edwards. 1977. The methodology of phylogenetic inference above the species level. Pages 3-51 in M.K. Hecht, P.C. Goody, and B.M. Hecht, ed. *Major patterns in vertebrate evolution*, Plenum, New York.
- Hennig, W. 1966. *Phylogenetic systematics*. Univ. Illinois Press, Urbana, 263 pp.
- Herzenstein, S. 1890. Ichthyologische Bemerkungen aus dem Zoologischen Museum der Kaiserlichen Akademie der Wissenschaften. *Melanges Biol. Bull. Acad. Imper. Sci. St. Petersbourg*, **13**:

- 113-126.
- Hubbs, C.L., W.I. Follett and L.J. Dempster. 1979. List of the fishes of California. *Occ. Pap. Calif. Acad. Sci.*, (133): 1-51.
- Irina, M.B. 1978. On the systematic status of the genus *Podothecus* Gill in the family Agonidae. Pages 13-24, figs. 1-9, in L.V. Shorenkova. *Morphology and Systematic of fishes*, Zool. Inst., Akad. Nauk. SSSR, Leningrad, 87 pp. (In Russian)
- Iredale, T. and G.P. Whitley. 1969. Chesnon's "Essai sur l'histoire Naturelle", 1835. *Proc. Roy. Soc. New South Wales*, 1967-68: 43-45.
- Ishikawa, C. 1904. Notes on some new or little known fishes of Japan. *Proc. Dept. Nat. Hist., Tokyo Imperi. Mus.*, 1: 1-17, pls. 1-7.
- Jenyns, L. 1842. Fish. In the zoology of the voyage of H.M.S. "Beagle", during the years 1832-1836 edited by Charles Darwin, London, Part 4, xvi+172 pp., 29 pls.
- Johnson, S.E. 1918. Osteology of the grunt fish, *Rhamphocottus richardsoni*. *J. Morph.*, 31(3): 461-487, pls. 1-4.
- Jordan, D.S. 1887. A catalogue of the fishes known to inhabit the water of North America, north of the Tropic of Cancer, with notes on the species discovered in 1883 and 1884. *Rep. U.S. Fish. Comm. for 1885*, part XIII: 789-973.
- Jordan, D.S. 1903. Correspondence to the editor of the American Naturalist. *Amer. Nat.*, 37: 360.
- Jordan, D.S. 1917. The genera of fishes, from Linnaeus to 1920, with the accepted type of each. A contribution to the stability of scientific nomenclature. *Stanford Univ. Publ., Univ. ser.*, part 1: 1-161.
- Jordan, D.S. 1920. The genera of fishes, from Linnaeus to 1920, with the accepted type of each. A contribution to the stability of scientific nomenclature. *Stanford Univ., Univ. ser.*, part 4: 411-576 + i-xviii.
- Jordan, D.S. and B.W. Evermann. 1896. A check-list of the fishes and fish-like vertebrates of North and Middle America. *Rep. U.S. Fish. Comm.*, for 1895: 207-584.
- Jordan, D.S. and B.W. Evermann. 1898a. The fishes of North and Middle America, a descriptive catalogue of the species of fish-like vertebrates found in the waters of North America, north of the isthmus of Panama. Part 2. *Bull. U.S. Natn. Mus.*, 47: i-xxx + 1241-2183.
- Jordan, D.S. and B.W. Evermann. 1898b. The fishes of North and Middle America, a descriptive catalogue of the species of fish-like vertebrates found in the waters of North America, north of the isthmus of Panama. Part 3. *Bull. U.S. Natn. Mus.*, 47: i-xxiv + 2184-3136.
- Jordan, D.S. and B.W. Evermann. 1900. The fishes of North and Middle America, a descriptive catalogue of the species of fish-like vertebrates found in the waters of North America, north of the isthmus of Panama. Part 4. *Bull. U.S. Natn. Mus.*, 47: i-ci + 3137-3313.
- Jordan, D.S., B.W. Evermann, and H.W. Clark. 1930. Check list of the fishes and fish-like vertebrates of North and Middle America north of the northern boundary of Venezuela and Columbia. *Rep. U.S. Fish. Comm.*, for 1928, part 2: 1-670.
- Jordan, D.S. and C.H. Gilbert. 1881a. Description of a new agonid fish (*Brachyopsis xyosterna*), from Monterey Bay, California. *Proc. U.S. Natn. Mus.*, 3: 152-154.
- Jordan, D.S. and C.H. Gilbert. 1881b. Description of a new agonid (*Agonus vulsus*), from the coast of California. *Proc. U.S. Natn. Mus.*, 3: 330-332.
- Jordan, D.S. and C.H. Gilbert. 1881c. List of the fishes of the Pacific coast of the United States, with a table showing the distribution of the species. *Proc. U.S. Natn. Mus.*, 3: 452-458.
- Jordan, D.S. and C.H. Gilbert. 1883. Synopsis of the fishes of North America. *Bull. U.S. Natn. Mus.*, (16): i-lvi + 1-1018.
- Jordan, D.S. and C.H. Gilbert. 1899. The fishes of Bering Sea. Pages 433-492, pls. 42-85, in D.S. Jordan, *Fur Seals and Fur-Seal Islands of the North Pacific Ocean*, part 3.
- Jordan, D.S. and C.L. Hubbs. 1925. Records of fishes obtained by David Star Jordan, 1922. *Mem. Carneg. Mus.*, 10(2): 93-346, pls. 5-12.
- Jordan, D.S. and J. Richardson. 1908. On a collection of fishes from Echigo, Japan. *Proc. U.S. Natn. Mus.*, 33, 1907: 263-266, figs. 1-3.
- Jordan, D.S. and J.O. Snyder. 1901. Descriptions of two new genera of fishes (*Ereunias* and *Draciscus*) from Japan. *Contribs. Biol. Hopkins Seaside Lab. Leland Stanford Junior Univ.*, (24): 377-380, pls. 18 and 19.
- Jordan, D.S. and E.C. Starks. 1895. The fishes of Puget Sound. *Proc. Calif. Acad. Sci.*, ser. 2, 5:

- 785-855, pls. 76-104.
- Jordan, D.S. and E.C. Starks. 1904. A review of the Japanese fishes of the family of Agonidae. *Proc. U.S. Natn. Mus.*, **27**: 575-599, figs. 1-13.
- Jordan, D.S., S. Tanaka, and J.O. Snyder. 1913. A catalogue of the fishes of Japan. *J. Coll. Sci., Tokyo Imp. Univ.*, **33**(1): 1-497, figs. 1-396.
- Kanayama, T. 1980. Intraspecific variation in the agonid fish, *Sarritor frenatus*. *Japan. J. Ichthyol.*, **26**(4): 364-366.
- Kanayama, T. 1983. Agonidae. Pages 290-291, 340 in Amaoka, K., K. Nakaya, H. Araya, and T. Yasui eds. *Fishes from the north-eastern Sea of Japan and the Okhotsk sea off Hokkaido*. Japan Fish. Res. Conserv. Associ., Tokyo.
- Kanayama, T. 1984. Family Agonidae. Pages 331-333, pls. 297-298 in Masuda, H., K. Amaoka, C. Araga, T. Uyeno and T. Yoshino eds. *The fishes of the Japanese Archipelago*, Tokai Univ. Press, Tokyo.
- Kanayama, T. 1991. Validity of the agonid fish, *Podothecus hamlini*, and the first confirmed record from Japanese waters. *Japan. J. Ichthyol.*, **38**(1): 77-79.
- Kanayama, T. and S. Maruyama. 1979. Agonid fishes, *Anoplagonus occidentalis* and *Bothragonus occidentalis*, from Japanese waters. *Japan. J. Ichthyol.*, **25**(4): 278-282.
- Katayama, M. 1940. A catalogue of the fishes of Toyama Bay. *Toyama Hakubutsu-gaku-kaishi*, (3): 1-28. (In Japanese).
- Kido, K. 1988. Phylogeny of the family Liparididae, with the taxonomy of the species found around Japan. *Mem. Fac. Fish., Hokkaido Univ.*, **35**(2): 125-256, figs 1-66.
- Kincaid, T. 1919. *An annotated list of Puget Sound fishes*. State of Wash. Dept. Fish., Olympia, 51 pp., 114 figs.
- Kröyer, H.N. 1845. *Aspidophorus spinosissimus*. *Naturh. Tidsskr.*, (n.s.), **1**: 250-253.
- Kuronuma, K. 1943. Fishes from Paramushiru I., northern Kuril Islands. *Bull. Biogeogr. Soc. Japan*, **13**(16): 101-124, fig. 1.
- Kusaka, T. 1974. *The urohyal of fishes*. Univ. Tokyo Press, Tokyo, xiv + 320 pp., 10 text-figs.
- Lacépède, B. 1801. *Histoire naturelle des Poissons. III*. Paris, 558 pp., 34 pls.
- Leim, A.H. and W.B. Scott. 1966. Fishes of the Atlantic coast of Canada. *Fish. Res. Bd. Canada, Bull.*, **155**: 1-459.
- Leipertz, S.L. 1985. A review of the fishes of the agonid genus *Xenertmus* Gilbert. *Proc. Calif. Acad. Sci.*, **44**(3): 17-40, figs. 1-18.
- Leipertz, S.L. 1988. The rockhead poacher, *Bothragonus swani* (Teleostei: Agonidae): Selected osteology, with comments on phylogeny. *Copeia*, **1988**(1): 64-71, figs. 1-6.
- Leviton, A.E., R.H. Gibbs, Jr., E. Heal and C.E. Dawson. 1985. Standards in herpetology and ichthyology: Part I. Standard Symbolic codes for institutional resource collections in herpetology and ichthyology. *Copeia*, **1985**(3): 802-832.
- Liem, K.F. 1970. Comparative functional anatomy of the Nandidae (Pisces: Teleostei). *Fieldiana Zool.*, **56**: 1-166.
- Lindberg, G.U. 1935. Description of a new species *Bothragonus occidentalis* (Agonidae: Pisces) from the Sea of Japan. *Bull. Acad. Sci. USSR, Classe Sci., mathema. nat.*: 1-5. (Transl. by L. Penny and edit. by B.B. Collette, Ichthyol. Lab., Bureau Comm. Fish. Wildlife Serv., U. S. Natn. Mus., Washington 25, D.C.)
- Lindberg, G.U. 1947. Preliminary list of fishes of the Sea of Japan. *Izv. Pac. Ocean Res. Inst. Fish. Oceanogr.*, **25**: 125-206 (In Russian).
- Lindberg, G.U. 1950. Description of a new species in the genus *Anoplagonus* Gill (Pisces, Agonidae) from the Sea of Japan. *Issled. Dal'nevost. Morei SSSR*, **2**: 303-304, figs. 1-2. (In Russian).
- Lindberg, G.U. 1959. A list of the fauna of southern Sakhalin and the southern Kuril Islands. *Issled. Dal'nevost. Morei SSSR*, **6**: 173-256. (In Russian).
- Lindberg, G.U. 1971. *Families of the fishes of the world; a checklist and a key*. Zool. Inst. Akad. Nauk SSSR, Leningrad, 472 pp. (In Russian).
(Transl. in English, *Fishes of the world: A key to families and a checklist*, Wiley, New York, 1974).
- Lindberg, G.U. and A.P. Andriashev. 1950. Survey of the genus *Sarritor* Cramer (Pisces, Agonidae) from the Far Eastern Seas. *Issled. Dal'nevost. Morei SSSR*, **2**: 293-302, figs. 1-3. (In Russian).

- Lindberg, G.U. and Z.V. Krasnyukova. 1987. *Fishes of the Sea of Japan and the adjacent areas of the Sea of Okhotsk and Yellow Sea*. Akad. Nauk. SSSR, Leningrad, part 4, 463 pp., 329 figs. (In Russian).
- Linnaeus, C. 1758. *Systema Naturae*, ed. X. Holmiae, vol. 1, 824 pp. (Nantes and Pisces: 230-338.)
- Lockington, W.N. 1880. Descriptions of new genera and species of fishes from the coast of California. *Proc. U.S. Natn. Mus.*, 2, 1879(1880): 326-332.
- Lockington, W.N. 1881. Description of a new species of Agonidae (*Brachyopsis verrucosus*) from the coast of California. *Proc. U.S. Natn. Mus.*, 3, 1880(1881): 60-63.
- Løvtrup, S. 1976. Phylogenetics: Some comments on cladistic theory and method. Pages 805-822. In Hecht, M.K., P.C. Goody, and B.M. Hecht, ed., *Major patterns in vertebrate evolution*, Plenum, New York.
- Lütken, C.F. 1876. Korte Bidrag til nordisk Ichthyographi. I. Foreløbige meddelelser om nordiske ulkefiske (Cottoidei). *Vidensk. Meddr dansk naturh. Foren., København.*: 355-388. Resume: 72-98.
- Lütken, C.F. 1886. Et Bidrag til Kundskab om Karahavets Fiske. In Dijnphna-Togtets *Zoologisk-botaniske Udbytte, København*: 1-40 (115-154), pls. 15-16.
- Lütken, C.F. 1898. The ichthyological results. *Dan. Ingolf Exped.*, 2(1): 1-38, 2 figs.
- Mabee, P.M. 1988. Supraneural and predorsal bones in fishes: Development and homologies. *Copeia*, 1988(4): 827-838, figs. 1-7.
- Matsubara, 1936. On the new species of fishes found in Japan. *Annot. Zool. Japan.*, 15(3): 355-360, figs. 1-3.
- Matsubara, K. 1943. Studies on the scorpaenoid fishes of Japan. Anatomy, phylogeny and taxonomy (I). *Trans. Sigenkagaku Kenkyusho*, (1): 1-170.
- Matsubara, K. 1955. *Fish morphology and hierarchy*. Part II. Ishizaki-shoten, Tokyo, i-v+791-1377 pp. (In Japanese).
- Matsubara, K. and A. Ochiai. 1955. A revision of the Japanese fishes of the family Platycephalidae (the flatheads). *Mem. Coll. Agri., Kyoto Univ.*, (68): 1-109.
- Mayr, E. 1969. *Principles of systematic zoology*. McGraw-Hill, New York, xi+428 pp., 65 figs.
- McAllister, D.E. 1968. Evolution of branchiostegals and classification of teleostome fishes. *Bull. Natn. Mus. Canada*, (221): i-xvi+1-239, pls. 1-19.
- Miller, D.J. and R.N. Lea. 1972. Guide to the coastal marine fishes of California. *Calif. Dep. Fish and Game, Fish. Bull.*, (157): 1-235.
- Monod, T. 1967. Le complexe urophore des Teleosteens: typologie et evolution (note preliminaire). *Colloques internationaux du centre national de la recherche scientifique*, 163: 111-131, figs. 1-16.
- Monod, T. 1968. Le complexe urophore des poissons teleosteens. *Mem. Inst. fr. Afr. noire*, 81: 1-705, figs. 1-989.
- Muus, B.J. and P. Dahlstrøm. 1974. *Collins guide to the sea fishes of Britain and North-western Europe*. Collins Sons and Co. Ltd., London, 244 pp.
- Nelson, G.J. 1969. Gill arches and phylogeny of fishes, with note on the classification of vertebrates. *Amer. Mus. Nat. Hist.*, 141(4): 477-552, figs. 1-26.
- Nelson, G.J. 1970. Outline of a theory of comparative biology. *Syst. Zool.*, 19(4): 373-384.
- Nelson, J.S. 1976. *Fishes of the world*. John Wiley and Sons, Inc., New York, xiii+373 pp.
- Nelson, J.S. 1984. *Fishes of the world*. 2nd ed. John Wiley and Sons, Inc., New York, xv+475 pp., 45 maps.
- Nishimura, S. 1974. *History of the Japan Sea*. Tsukiji-shokan, Tokyo, v+227 pp., 72 figs. (In Japanese).
- Okada, S. and K. Kobayashi. 1968. *Colored illustrations of pelagic and bottom fishes in the Bering Sea*. Hokuyo Sakemasu Shigenchosa-kenkyukai and Nippon Suisanshigen Hogokiyokai, Tokyo, x+179 pp., 48 figs., 24 pls. (In Japanese).
- Pallas, P. 1769. *Specilegia Zoologica*. I. Pisces, Berlin, 42 pp., 6 pls.
- Pavlenko, M.N. 1910. Fishes of Peter the Great Bay. *Trd. Obsc. Yest.*, 42(2): 1-95, pls. 1-10. (In Russian).
- Quast, J.C. 1965. Osteological characteristics and affinities of the hexagrammid fishes, with a synopsis. *Proc. Calif. Acad. Sci.*, 31(21): 563-600.
- Quast, J.C. and E.L. Hall. 1972. List of fishes of Alaska and adjacent waters with a guide to some

- of their literature. *NOAA Tech. Rep. NMFS SSRF-658, U.S. Dep. Com.* : i-iv+1-47.
- Regan, C.T. 1913. The osteology and classification of the teleostean fishes of the order Scleroparei. *Ann. Mag. Nat. Hist., ser. 8, 11* : 167-187.
- Rendahl, H. 1934. Studien über die Scleroparei. 1. Zur Kenntnis der Kranialen Anatomie der Agoniden. *Ark. Zool., 26A(13)* : 1-106, figs. 1-28.
- Ribeiro, A.M. 1918. Dous generos e tres especies novan de peixes brasileiros determinados nas colleções do Museu Paulista. *Revista Mus. Paulista, Sao Paulo, 10* : 787-791, pl. 1.
- Richardson, J. 1836. The fish. part III. Pages i-xv+1-327, pls. 74-96 in *Fauna Boreali Americana, or the zoology of the northern parts of British America, containing descriptions of the objects of natural history collected on the late northern land expeditions, under the command of Sir John Franklin R.N.* 4 vols., London and Norwich, 1831-37.
- Sasaki, T. 1972. Demersal fishes collected in the southeastern shelf waters of Alaska. *Bull. Fac. Fish., Hokkaido Univ., 22(4)* : 281-289, fig. 1.
- Schaeffer, B. and D.E. Rosen. 1961. Major adaptive levels in the evolution of the actinopterygian feeding mechanism. *Amer. Zool., 1* : 187-204, figs. 1-7.
- Schmidt, P.J. 1904. *Pisces marium orientaliuum Imperii Rossici.* St.-Petersburg, xi+466 pp., 31 figs., 6 pls. (In Russian).
- Schmidt, P.J. 1936. On the systematics and distribution of the genus *Agonus* Bloch and Schneider. *Copeia, 1936(1)* : 58-59.
- Schmidt, P.J. 1950. Fishes of the Sea of Okhotsk. *Trudy Tikhookean. Kom., 6* : 1-370, pls. 1-20. (In Russian).
- Schultz, L.P. 1936. Key to the fishes of Washington, Oregon and closely adjoining regions. *Univ. Wash. Publ. Biol., 2(4)* : 103-228.
- Scopoli, I.A. 1777. *Introductio ad historiam sistens genera lapidum, plantarum, at animalium hactenus detecta, caracteribus essentialibus donata, in tribus divisa, subinde ad leges naturae.* Pages 445-495. Prague, x+506 pp.
- Sneath, P.H.A. and R.R. Sokal. 1973. *Numerical taxonomy. The principles and practice of numerical classification.* W.H. Freeman and Company, San Francisco, xv+573 pp., 81 figs.
- Snyder, J.O. 1911. Description of new genera and species of fishes from Japan and the Riu Kiu Islands. *Proc. U.S. Natn. Mus., 40(1836)* : 525-549.
- Soldatov, V.K. and G.J. Lindberg. 1930. A review of the fishes of the seas of the Far East. *Bull. Pacific Sci. Fish. Inst., 5* : i-xlvi+1-549, figs. 1-76.
- Starks, E.C. 1896. List of fishes collected at Port Ludlow, Washington. *Proc. Calif. Acad. Sci., ser. 2, 6* : 549-562, pls. 74-75.
- Starks, E.C. 1926. Bones of the ethmoid region of the fish skull. *Stanford Univ. Publ. Univ. Ser., Biol. Sci., 4(3)* : 139-338.
- Starks, E.C. 1930. The primary shoulder girdle of the bony fishes. *Stanford Univ. Publ., Univ. Ser., Biol. Sci., 6(2)* : 149-239.
- Steindachner, F. 1877. Über einige seltene oder neue Fischarten von der Westküste der nordlichen Theile Nordamerika's. *Sitzb. K. Akad. Wiss., Wien, 74(1)* : 176-202, pls. 4, 5, 14.
- Steindachner, F. 1881. Über zwei neue Agonus-Arten aus California. *Sitzb. K. Akad. Wiss., Wien, 82(1)* : 253-255, pls. 5, 6.
- Swainson, W. 1839. *On the natural history and, classification of fishes, amphibians, and reptiles, or monocardian animals.* London, vol. 2, 448 pp., 135 figs.
- Taliev, D.N. 1955. *Sculpins of Baikal (Cottoidei).* Akad. Nauk, SSSR, East Siberia Branch, Moscow, 603 pp., 179 figs. (In Russian).
- Tanaka, S. 1931. On the distribution of fishes in Japanese waters. *J. Fac. Sci. Imp. Univ. Tokyo, 3(1)* : 1-90.
- Taranetz, A.Y. 1933. New data on ichthyofauna of the Bering Sea. *Bull. Far-East Branch Acad. Sci. USSR, (1-3)* : 67-78, figs. 1-4. (In Russian).
- Taranetz, A.Y. 1935. Some changes in the classification of fishes of the Soviet Far East with notes on their distribution. *Bull. Far-East Branch, Akad. Nauk. USSR, (13)* : 99-102.
- Taranetz, A.Y. 1937. Handbook for identification of fishes of Soviet Far East and adjacent waters. *Bull. Pacific Sci. Inst. Fish. Oceanogr., 2* : 1-200. (In Russian).
- Taranetz, A.Y. 1941. On the classification and origin of the family Cottidae. *Izv. Imp. Akad. Nauk., Biol., 3* : 429-447, 4 figs. (In Russian with English summary).

- Thompson, W.F. 1916. Fishes collected by the united states bureau of fisheries steamer "Albatross" during 1888, between Montevideo, Uruguay, and Tome, Chile, on the voyage through the straits of Magellan. *Proc. U.S. Natn. Mus.*, **50**(2133): 401-476, pls. 1-6.
- Tilesius, W.G. 1809. Description de quelques poissons observés pendant son voyage autour du monde. *Mém. Soc. Imp. Nat., Moscou*, **2**: 212-268, pls. 13-17.
- Tilesius, W.G. 1813. Iconum et descriptionum Piscium Camtschaticorum continuatio tertia, tentamen monographiae generis Agoni blochiani sistens. *Mém. Acad. Imp. Sci., St. Pétersburg*, 1811, **4**: 406-478, pls. 11-16.
- Tilesius. 1814. Animalia monocardia seu frigidi sanguinis imperii Rosso-Asiatici... Supplendis quibusdam ranarum descriptionibus et iconibus inprimis piscium Kamtschaticorum auxit, et locupletavit G.T. Tilesius In Pallas, P.S., *Zoographia Rosso-Asiatica...* vol. 3, 428 pp.
- Ueno, T. 1967. Fishes of the adjacent waters of Hokkaido. 25. Agonid fishes. *Hokusuishigepo, Rep. Hokkaido. Fish. St.*, **24**(2): 10-28, figs. 1-5. (In Japanese).
- Ueno, T. 1970. *Fauna Japonica: Cyclopteridae (Pisces)*. Acad. Press Japan, Tokyo, 233 pp., 13 pls.
- Valenciennes, A. 1858. Description d' une nouvelle espece d' *Aspidophore* pêché dans l' une des anses du port del' empereur Nicholas (Manch de Tartarie), et rapporté par Barthe, chirugien du bord de la frégate la Sibgile, Commandée par M. Simonet de Maisonneuve, capitaine de vaisseau. *Compt. Rend. Séances Acad. Sci. Paris*, **47**: 1-4.
- Vladykov, V.D. 1933. Biological and oceanographic conditions in Hudson Bay. 9. Fishes from the Hudson Bay region (except the Coregonidae). *Contribs. Canad. Biol. Fish.*, ser. A, **8**(2): 1-49.
- Watanabe, M. 1958. *Studies on the sculpin of Japan and its adjacent waters*. Kadokawa-shoten, Tokyo, 416 pp., 123 pls. (In Japanese).
- Whitley, G.P. 1950. New fish names. *Proc. Royal Zool. Soc., New South Wales*, **1948-49**: 1-44.
- Wilimovsky, N.J. 1954. List of the fishes of Alaska. *Stanford Ichthyol. Bull.*, **4**(5): 279-294, fig. 1.
- Wilimovsky, N.J. and D.E. Wilson. 1978. A new species of Agonidae, *Agonomalus mozinoi*, from the west coast of North America. *Syesis*, **11**: 73-79, fig. 1.
- Yabe, M. 1981. Osteological review of the family Icelidae Berg, 1940 (Pisces; Scorpaeniformes), with comment on the validity of this family. *Bull. Fac. Fish. Hokkaido Univ.*, **32**(4): 293-315.
- Yabe, M. 1985. Comparative osteology and myology of the superfamily Cottoidea (Pisces: Scorpaeniformes), and its phylogenetic classification. *Mem. Fac. Fish., Hokkaido Univ.*, **32**(1): 1-130, figs. 1-62.
- Yabe, M., D.M. Cohen, K. Wakabayashi and T. Iwamoto. 1981. Fishes new to the eastern Bering Sea. *Fish. Bull.*, **79**(2): 353-356, fig. 1.