



Title	ON THE MEASUREMENT OF OCEAN WAVES : . A Telemetering System for the Measurement of Ocean Waves by Means of the Use of a Bamboo Stick Wave Pole
Author(s)	KAWASHIMA, Rihei
Citation	北海道大學水産學部研究彙報, 14(1), 7-21
Issue Date	1963-05
Doc URL	<a href="http://hdl.handle.net/2115/23169">http://hdl.handle.net/2115/23169</a>
Type	bulletin (article)
File Information	14(1)_P7-21.pdf



[Instructions for use](#)

# ON THE MEASUREMENT OF OCEAN WAVES

## I. A Telemetering System for the Measurement of Ocean Waves by Means of the Use of a Bamboo Stick Wave Pole

Rihei KAWASHIMA

*Faculty of Fisheries, Hokkaido University*

### Abstract

General descriptions of a bamboo wave pole and of a measuring and telemetering system of ocean waves are presented. The mechanism and circuitry in the radio telemetering system which is designed by the author are detailed.

### I. Introduction

On the studies of the ship's motions in a seaway, especially on the frequency response characteristic of the ship's motions induced by ocean waves, it is no wonder that the measurement and analysis of ocean waves are important problems as the waves represent the input forces to the dynamical system of the ship's motions. As described in the former paper, let consider action be given to the system of the ship's motions having an impulsive response  $k(t)$  and transfer function  $\Phi(j\omega)$ , in which the ship's motions are assumed to be a linear dynamical system and it is supposed that the stationary random signal  $m(t)$ , which corresponds to the ocean waves in this case, has spectral density  $S_m(\omega)$  as the input to this system.

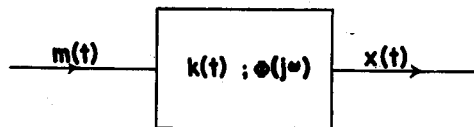

Fig. 1. A linear dynamic system

When the output signal  $x(t)$  which corresponds to the ship's motions induced by ocean waves has a spectral density  $S_x(\omega)$ , one can find the following relations by the theory of linear dynamical system:

$$x(t) = \int_{-\infty}^{\infty} m(t-\lambda)k(\lambda)d\lambda \quad (1)$$

$$S_x(\omega) = |\Phi(j\omega)|^2 S_m(\omega) \quad (2)$$

As a matter of fact, ocean waves are quite irregular phenomena. According to W. J. Pierson's theory in the power spectrum analysis of ocean waves, presuming that the wave train passing a stable point on sea surface is considered as a

stationary random process, the power spectrum is calculated on the time series which is sampled from the record of the wave pressure or wave heights at an observation point. As for the calculations, the length of sampling record is required to be for 20 minutes for the spectrum.

In recent years, the measurement of ocean waves in the near shore zone has been performed by an instrument which is placed on the bottom or attached to a permanent structure, by which means the fairly good results have been obtained. But, concerning the measurement of ocean waves in the deep water zone, there are still several difficulties, that is: i) to get a stable point from which the vertical distance to sea surface should be measured, ii) reading and recording the value of the vertical distance continuously over a long time.

In this paper, the author presents a general description of the measurement of ocean waves which up to the present he has been studying with reference to the method of recording and telemetering for the measurement of ocean waves using a bamboo stick wave pole.

## II. The measurement of ocean waves

*Ocean waves in deep water:* According to the theory of waves in classical hydrodynamics, the wave has been defined as the wave in deep water, such as to satisfy the following relation:

$$h > \frac{1}{2}L \quad (3)$$

Where,  $h$ : Depth of sea bottom;  $L$ : Wave length

As for the wave motion in deep water, the wave length, period and velocity are interrelated as follows:

$$C = \frac{g}{2\pi} \quad (4)$$

$$L = \frac{g}{2\pi} T^2 \quad (5)$$

$$T = \frac{2\pi}{g} C \quad (6)$$

Where,  $T$ : Wave period;  $C$ : Wave velocity

However, for the actual sea surface, for example, though the wave period defined as the time interval between two successive crests, that might be the period in the loose popular sense. It certainly is not the period in the exact mathematical sense of the word. In the same meanings, the other wave properties which are defined in the above theory are seldom applicable to actual sea surface.

In several papers, the wave properties in actual sea are treated statistically

on the wave motions, for example, the relation between the average time interval between successive crests  $\tilde{T}$  to the average distance between the successive crests  $\tilde{L}$  at a fixed point are given as follows:

$$\tilde{L} = \frac{2}{3} \cdot \frac{g}{2\pi} \tilde{T}^2 \quad (7)$$

In the spectrum theory of ocean waves in actual sea, proposed by G. Neumann and others, the sea surface is the superposition of an infinite sum of infinitesimally high simple sinusoidal waves combined at random phase and travelling in different directions. As the purpose of this paper is to discuss the measurement of ocean waves in the deep water zone in actual sea, it is required that the meaning of measurement of ocean waves be made clear.

*Measurement of ocean waves:* In actual sea, the sea surface is so confused that the information which one can get from it is restricted for various reasons. In such condition, the measurement of ocean waves which is expected to be done is to measure and record the vertical distance from a fixed point to sea surface, continuously. In principle, the procedures for the measurement of ocean waves are as follows:

- i) To consider a standard stable fixed point on the sea surface which may be taken as the layer of still water
- ii) To measure and record the vertical distance from this fixed point to the actual sea surface

The characteristic of ocean waves which might be taken as the statistical properties such as the average wave height and average period should be found by analysis of the above record. From the view point of the time series analysis of ocean waves, the length of record for the vertical distance should extend for at least 30 minutes continuously, such is accepted as the reasonable length of record for calculation in the theory.

As for the actual method of measurement of ocean waves, the wave pole has been used in deep water zone. There are two ways of thinking about the wave pole as follows:

- 1) Froude wave pole

This is the best known method for the measurement of ocean waves in deep water. Fig. 2 shows a diagram illustrating its principle. In a former paper; the author made use of this method, in which the bamboo stick pole was used as the wave pole. This bamboo stick wave pole which consists of a bamboo stick, rope canvas and weight are rigged as follows:

1. Length of the pole above still water surface—a half length of the maximum wave heights to be measured

2. Length of rope connecting the pole and canvas—to be longer than a half of the wave length to be measured

3. Marks for reading wave heights—Marked white and red every 20 cm apart

The principle of the wave pole:

The relation between the amplitude of surface wave and that of sub-surface wave is given as the theory of wave motion by the following equation.

$$h = h' e^{-2\pi z/L} \quad (8)$$

Where:  $h$ : the amplitude of surface wave;  $h'$ : the amplitude of sub-surface wave. When the wave pole is rigged as above prescribed, the amplitude of vertical movement of sub-surface near the canvas is about  $\frac{1}{23}$  of that of the surface movement. Setting the wave pole in an observation point, though vertical motion will be induced by the surface waves, of which the directions of movement are upward to the crest coming and downward to the trough coming, the canvas which has the damping effect upon movement, affords resistance against this movement and keeps the wave pole stable to the motions, as if the pole were set up perpendicularly to the sea bottom. Consequently, as a fixed point can be set on the wave pole, the measurement of ocean waves is to record the relative vertical distance which is defined as from the fixed point which is taken from the still water surface line on this pole to sea surface.

2) The wave pole as a freely floating buoy

When the bamboo stick pole stands freely on the sea surface like a floating buoy, the pole should respond to the forces due to ocean waves acting on it. Provided the pole keep as shown in Fig. 3(a), it is necessary to consider the vertical movement of the pole for the measurement of wave heights the other motions may be neglected because of smallness in this case. Assuming that the vertical motions of the pole is linear vibration having restoring force due to buoyancy, the wave pole is designed with the suitable frequency characteristic against the frequency range of ocean waves to be measured.

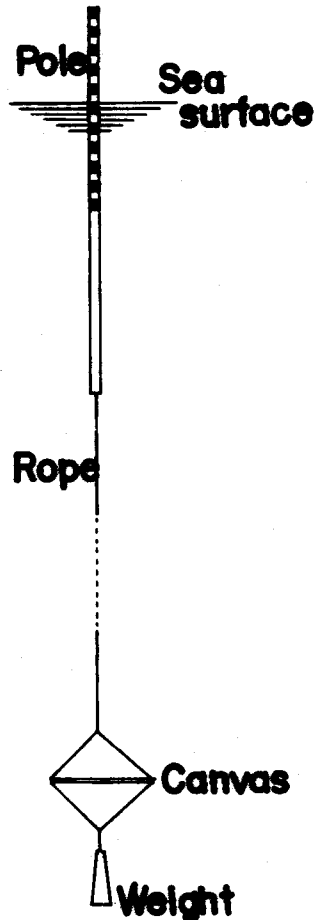

Fig. 2. Schematic diagram of Froude wave pole

Therefore, the ocean waves can be measured and recorded as the vertical distance from the fixed point on the pole to the sea surface by this method of the floating pole.

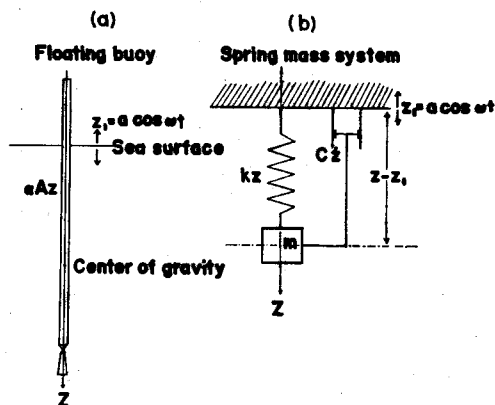

Fig. 3. Equivalent system of forces for floating wave pole

For the illustrating of the principle, let the equivalent system of forces for the floating pole be considered. As shown in Fig. 3(b), according to the theory of vibration in the linear dynamical system, presumed that ocean waves consist of the superposition of many component regular sinusoidal waves, the relation between the relative wave heights and actual input wave heights in this system are given as follows:

$$h = 2a \frac{\lambda^2}{\sqrt{(1-\lambda^2)^2 + (2\gamma\lambda^2)^2}} \quad (9)$$

$$\lambda = T_0/T, \quad T_0 = 2\pi\sqrt{m/k}, \quad \gamma = C'/C_c, \quad C_c = 2\sqrt{mk}$$

Where:  $h$ : Wave height which is defined as the vertical distance from trough of the wave to its crest

$T_0$ : Undamped natural period of the vertical motion of the pole ( $=2\pi/\omega_0$ )

$T$ : Period of exciting forces (wave period)

$m$ : Mass of the wave pole system

$k$ : Spring constant ( $=\alpha A$ )

$\alpha$ : Unit weight of the sea water

$A$ : Cross sectional area of the wave pole

$\omega_0$ : Angular frequency of the natural vertical motion

$\omega$ : Angular frequency of the input wave ( $=2\pi/T$ )

$a$ : Amplitude of the input wave to be measured

$\lambda$ : Tuning factor

$C'$ : Damping coefficient

$C_c$ : Critical damping coefficient

Concerning equation (9), as measurement can be made of the vertical distance  $h$  which is defined in the above section, it may safely said that the more accurately for the measurement of ocean waves, the larger the value of  $\lambda$  should be taken, which has the same meaning as that the natural period of the vertical motion of the pole should be taken longer comparing to the period of ocean waves to be measured. As an example of this kind of wave pole, WHOI wave pole is shown in Fig. 4. The slender part of the pole in this figure is the sensing element by which the vertical distances are converted to electrical analog signals. This pole is devised not only that it may be very stable against pitching and rolling motions, but also the natural period of vertical oscillation is made large by keeping the cross sectional area of the portion of the wave pole piercing the sea surface as small as practical and by keeping the whole mass of the set-up large.

*Reading and recording of the vertical movement of the sea surface*

The concept of measurement of ocean waves has already been stated, let consider the method of reading and recording of this movement. From the view point of analysis of ocean waves, it is obvious that the longer the recording the better. For the purpose of recording as long as possible, the author has used an 8 mm cine camera for measuring of ocean waves, in which devised a sampling mechanism with the cine camera having a specially designed shutter as shown in Photo 1. This mechanism consists of a spring driving 8 mm cine camera 'YASHIKA' an electrical timing watch, a shutter with electrical driving part and battery supply 6v. Describing the device of the mechanism, the average film length driven by a full wound spring for 8 mm cine camera numbered about 540 frames corresponding to about 3 minutes 20 seconds, 16 frames per second of film moving speed. Therefore, when the film driving speed is controlled by the shutter devised to expose one frame per second using the electrical timing watch, the time for the above mentioned average film length is extended to about 9 minutes. An example of this record is shown in Photo 2, this system being used for recording of the

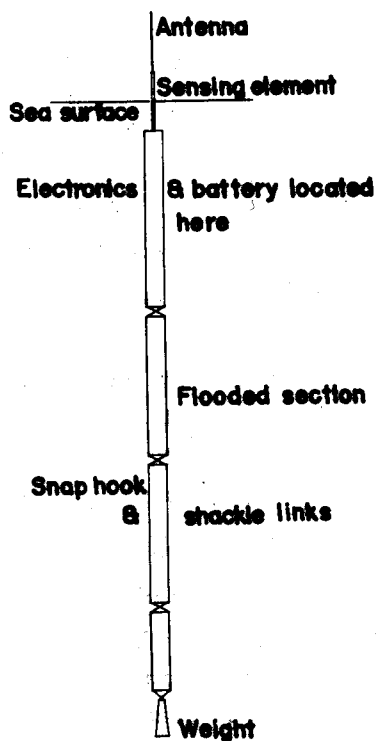

Fig. 4. Schematic diagram of WHOI wave pole

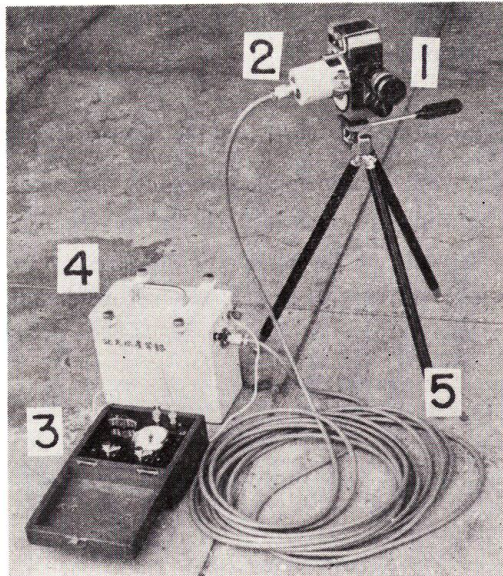

Photo 1. Specially designed shutter for 8 mm cine camera

1. 8 mm cine camera, 2. Shutter devised to expose one frame per second,
3. Deck watch which contain the electrical contact switch,
4. Battery supply 6 v, 5. Electric cord

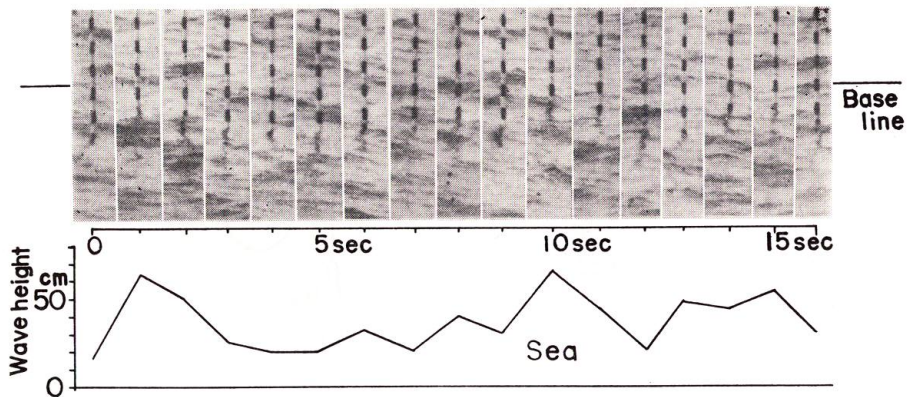

Photo 2. Sample wave record obtained with 8 mm cine camera

vertical movement of sea surface. However, there are some defects in this method as follows:

- i) General defects in photographic method in this kind of observation
- ii) Difficulty in using cine camera on the deck of a ship which is pitching and rolling due to ocean waves
- iii) Difficulty for keeping the cine camera stable directed to an object for a long time



Thereupon, it was concluded that a radio telemetering method should be used for the measurement of ocean waves.

### III. On the design of an instrument for the measurement of ocean waves

In the design of a wave measuring instrument, the radio telemetering system was employed for recording of measured ocean waves; it was designed by the present author. The purpose of the section of this paper is to describe the method. The essential parts are 1) wave pole and 2) telemetering apparatus.

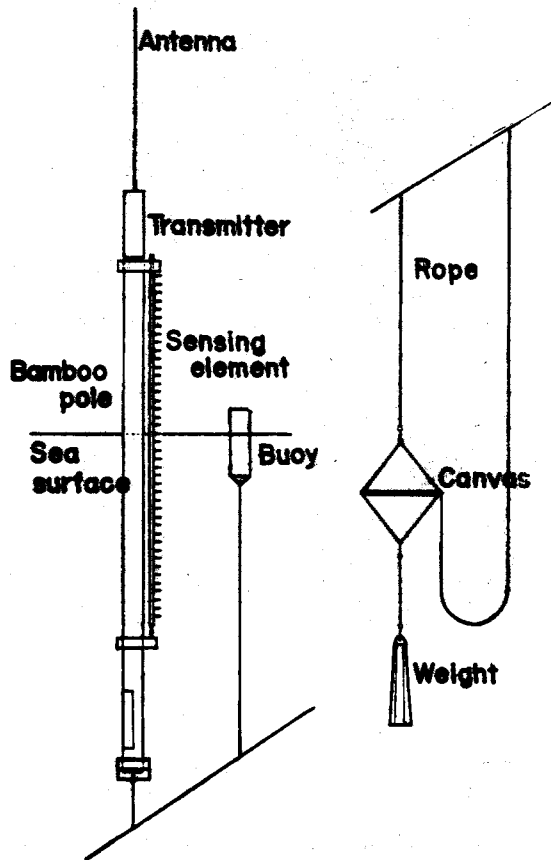

Fig. 5. Schematic diagram for the wave pole rigging telemetering apparatus

Fig. 5 illustrates the general arrangement of the wave pole, and Fig. 6 illustrates the radio telemetering system, respectively. The outline of this method is described as follows:

In order to make conversion from the above defined vertical distance to an

electrical value, the sensing element which has a lot of electrical contact points in which electrical resistances are settled between them is attached to the bamboo stick pole as illustrated in Figs. 5 and 7.

Assuming the sea water is to be an electric conductor, when the vertical distance has changed due to the movement of sea surface, so as to change the number of contact points in the sea water, consequently the electrical resistance has changed in correspondence to the number. In this manner, the change of resistance of the sensing element causes the frequency of audio multivibrator to vary. This audio frequency multivibrator amplitude modulates the RF amplifier of the transmitter which is crystal-controlled and operates on 27.13 megacycles.

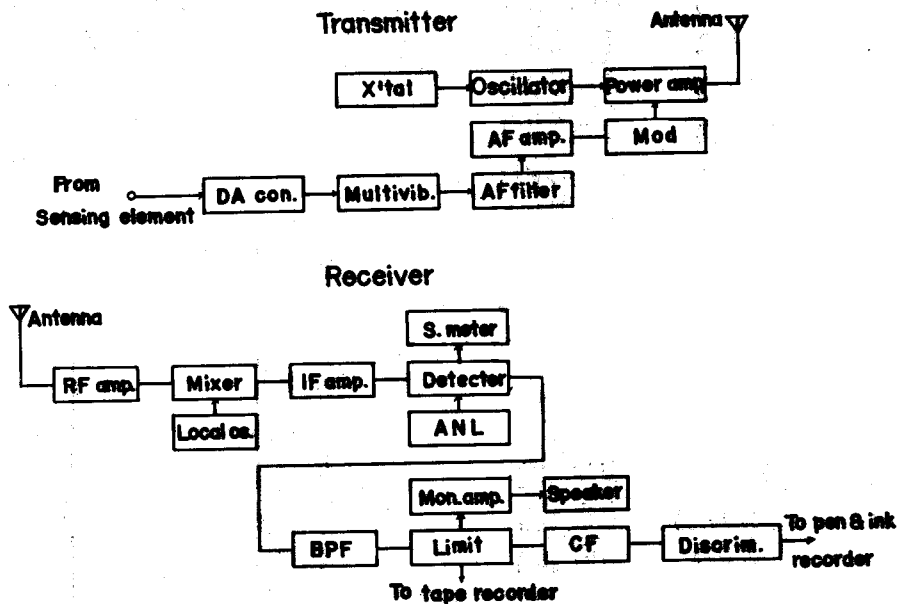

Fig. 6. Schematic diagram for telemetering system

The range of the telemeter is approximately above 2 km. The receiving and recording apparatus are located on a ship standing by the wave pole. The audio output from the receiver can be recorded on a magnetic tape or put on a pen and ink recorder using a frequency discriminator. The latter procedure give a direct graphic representation of the sea surface. Schematic diagram for the whole telemetering system is shown in Fig. 6. Now, let the electric design of the instrument be detailed as follows:

(1) *Transducer*: The sensing element is attached to the wave pole, the case of the electric unit in which is included the battery supply, is placed on the top of the wave pole. The structure of the sensing element is shown in Fig. 8. The

pole is vinyl pipe of 2 cm diameter, 4 m long which has 40 pieces of electrical contact pick-up steps at every 10 cm distance as shown in figure. The electrical resistance between the steps respectively is settled as shown in Fig. 7.

(2) *Transmitter*: The electrical circuit for the wave pole, a radio transmitter audio frequency multivibrator and battery supply are contained in the transmitter.

Block diagram and circuit of transmitter are shown in Figs. 6 and 9, respectively. The center frequency of multivibrator is about 550 c/s. The range of frequency against that of resistance change from 8 kΩ to 202 kΩ in the transducer corresponds to that from 700 c/s to 400 c/s which in turn corresponds to 4 m wave height in full scale. The frequency change per 10 cm of immersion is about 7.5 c/s.

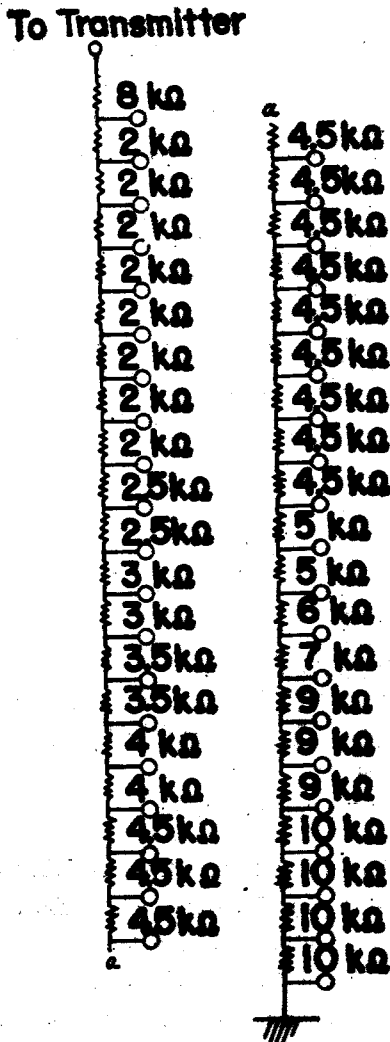

Fig. 7. Electronics for sensing element

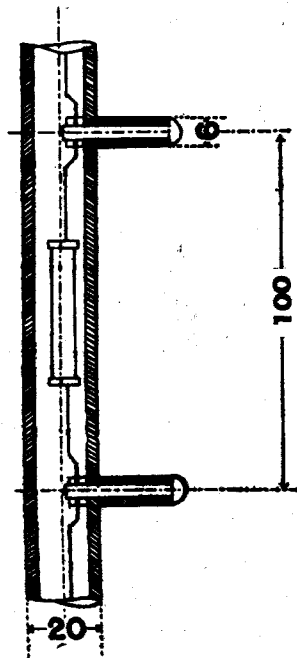

Fig. 8. Drawing of diagram for sensing element

The stability of audio frequency modulator is below 1%. The specified items for transmitter are as follows:



The bamboo stick wave pole rigged with the sensing element, transmitter and battery supply was tested as follows:

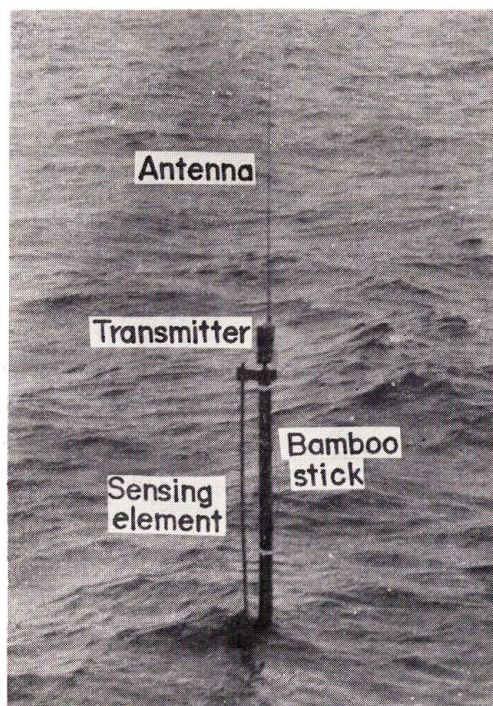

Photo 3. Bamboo stick wave pole with telemetering apparatus

Table I. Dimensions of Bamboo pole

Weight	13.0 kg
Length	7.80 m
Diameter in upper cut end	6.20 cm
lower cut end	8.80 cm
Distance from center of gravity to lower end	3.37 m
Total buoyancy in water	34.46 kg
Total buoyancy in sea water	35.32 kg
Buoyancy assumed in operation (2 m above the sea surface)	26.27 kg

Table II. Weight list Telemetering apparatus

Transmitter	1.6 kg
Sensing element	1.5 kg
Rope and shackles	1.5 kg
Total weight	4.6 kg

1) Sinking of the bamboo stick pole: On account of the change of humidity of bamboo stick pole, the wave pole has a tendency to sink gradually in sea water. Keeping the pole in still water area about 3 hours, recording the above mentioned vertical distance on recorder chart, it was found that the pole was sinking at the rate of 10 cm per hour.

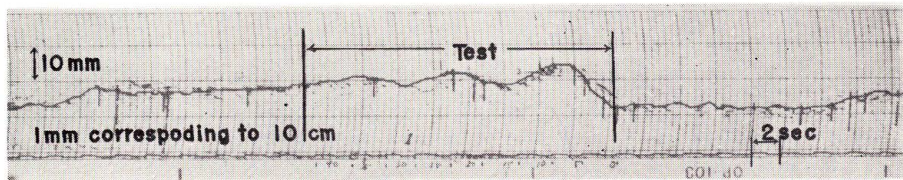

Fig. 10. Sample for the recording chart in test 1

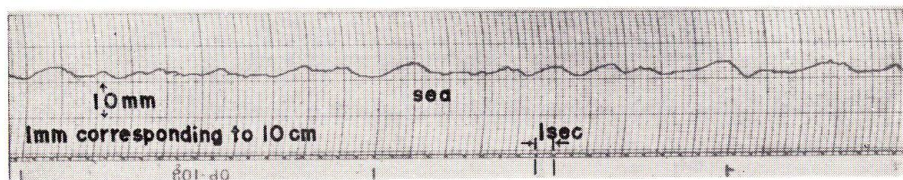

Fig. 11. Sample for recording chart of measuring ocean waves

2) Frequency characteristics: In order to get the frequency characteristic of the wave pole, under the same conditions as those of the above test, the damping curve for the vertical motion of the wave pole was taken in the next stated way. At first, force the wave pole by hand into the water to a depth of 2 m from the equilibrium condition on still water surface, then let the wave pole float free.

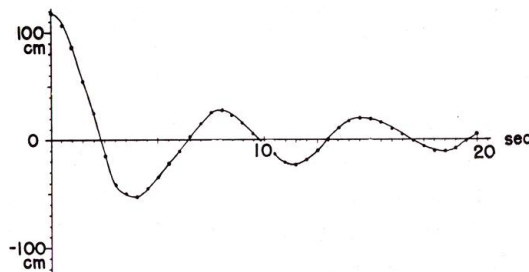

Fig. 12. Impulsive response for test 1

Consequently, by recording the vertical movement of the pole, the damping curve of vertical oscillation of the pole was obtained. The frequency response was calculated by the theory of linear vibration system on this damping curve. These curves are shown in Figs. 12 and 13, respectively.

*Experiment for the measurement of ocean waves off the port of TOMAKOMAI*

On August 17th 1962, the experiment was performed from the patrol boat *MRYOCHIDORI* at a position 10,000 meters off TOMAKOMAI to the south (Appx. Lat.  $42^{\circ}-32'.4$  N,  $141^{\circ}-39'.5$  E), depth of water being about 45 meters. The wind condition was Beaufort 2 from the south. The experiment was started at 1100 and the vertical movement recorded for about 1 hour three times.

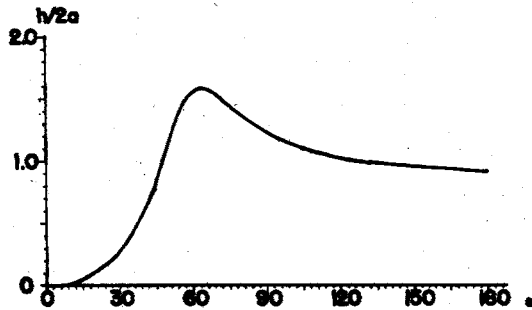

Fig. 13. Theoretical response of the wave pole to a sinusoidal sea surface

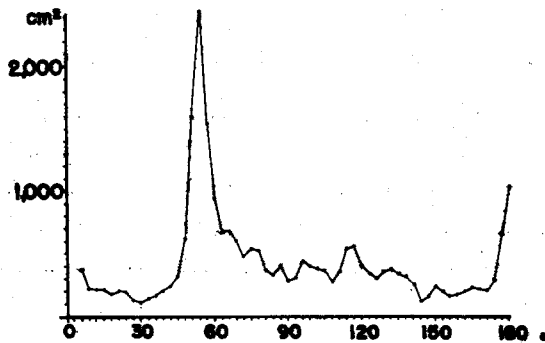

Fig. 14. Spectrum for measuring ocean waves

At the observation point, setting the wave pole in the sea water, the ship was allowed to drift near the wave pole. Passing 30 minutes after starting all elements of the apparatus, the measurement was commenced and continued about 1 hour continuously, at every observation. The ship was keeping her position within the range of about 2 km from the wave pole. The sensibility of receiving was fairly good. The sample of this recording and its spectrum are shown in Figs. 11 and 14.

#### V. Discussion

Considering the results of the experiment, it can be said that as for the telemetering system in the measurement of ocean waves, the instrument above described satisfied its aim according to the author's expectation. But, as a matter

of the design of a wave measuring instrument, several basic problems still remain as follows:

1) Improvement of the wave pole, especially on the frequency response

According to the theory of floating buoy for the wave pole, the natural period of the vertical motion of the wave pole should be large compared with the period of ocean waves to be measured. The improvement of the wave pole should be made from this point of view.

2) Improvement of telemetering apparatus

As shown in the oscillograph recorded chart, when the water surfaces is coming down against the sensing element does not show clear step type function. This is due to the electrical properties of sea water. The improvement of this point has already been made in the measurement of coastal waves where the step type wave pole is used, but in this case, there are several difficulties in the realization of improvement.

3) Concerning the above betterment, the mechanical design of the wave pole needs to be changed, and the weight of the sensing element should be lightened.

As to these improvements, the present author has designed a new floating buoy type wave pole which will discussed in succeeding paper.

#### VI. Acknowledgment

In conclusion, the author wishes to express his thanks to Professor Y. Hattanda for his kind advice, to Assistant Professor O. Sato and Leturer Y. Inaba for their kindly help in the experiment off the port TOMAKOMAI.

Lastly, particular thanks are due to Dr. Yamanouchi Chief of the Division of Ship Sea Qualities in the Transportation Technical Research Institute, who gave the author kindly help for the experiment in Tokyo Bay.

#### Literature cited

- Yamanouchi, Y. (1962). On the analysis of ship oscillation among waves. *Soc. Nav. Arch. Japan*, 111, 139-151
- Pierson, W. J. (1954). An electronic wave spectrum analyser and its use in engineering problems. *Beach Erosion Board Tech. Memo.* 56, 91
- Neumann, G. (1953). On ocean wave spectra and a new method for forecasting wind generated sea. *Beach Erosion Board Tech. Memo.* 43, 42
- Willard, J. (1954). An interpretation of the observable properties of 'sea' waves in terms of the energy spectrum or the gaussian record. *Trans. Amer. Geophy. Union* 35(5), 747-757.
- Johnson, J. W. (1954). *Ships and waves*. 509 p. California; Concl Wave Research and Soc. Nav. Arch. Mar. Eng.