



Title	Configuration of Migmatite Dome Comparative Tectonics of Migmatite in the Hidaka Metamorphic Belt
Author(s)	Kizaki, Koshiro
Citation	Journal of the Faculty of Science, Hokkaido University. Series 4, Geology and mineralogy, 15(1-2), 157-172
Issue Date	1972-03
Doc URL	http://hdl.handle.net/2115/36009
Type	bulletin (article)
File Information	15(1-2)_157-172.pdf



[Instructions for use](#)

CONFIGURATION OF MIGMATITE DOME
COMPARATIVE TECTONICS OF MIGMATITE IN
THE HIDAKA METAMORPHIC BELT

by

Koshiro KIZAKI

(with 16 Text-Figures)

(Contribution from the Department of Geology and Mineralogy,
Faculty of Science, Hokkaido University, No. 1227)

Introduction

The Hidaka metamorphic belt which represents the geological backbone of the Hokkaido island in northern Japan, is composed of various metamorphics and migmatites of pelitic and psamitic origin and also is characterized by thick sheets of basic intrusives which were metamorphosed to various amphibolites. Basic and ultrabasic plutonics as olivine gabbro, norite, gabbro and periodotite are significant in the belt. The core portion of the belt is occupied by the migmatites which are classified to biotite migmatite, cordierite migmatite and granitic migmatite of agmatitic, schollen, nebulitic and anatexitic natures, while sometimes of massive kind (Fig. 1). The radiometric age of these migmatites indicates 30 – 40 my by K–A method (Kawano et al, 1967). So that with other geological informations, the age of the metamorphism and migmatization should be around from Cretaceous to Tertiary. The petrography of the metamorphic rocks and migmatites of the belt has been published by several authors (HIROTA, 1963, HUNAHASHI, et al, 1956, KIZAKI, 1964, TONOZAKI, 1965, etc.). The general picture on the Hidaka orogeny in the Alpine period has been presented by HUNAHASHI, and KIZAKI, (HUNAHASHI, 1957, KIZAKI, 1964).

The migmatite forming dome and arch along the core zone are divided into several tectonic units throughout the belt though some of the units are not clear yet. The major units, however, have been investigated to classify from the tectonic facies view points. The conception of tectonic facies which is provided by the scale, shape and composition of the structure, has been originally defined by HARLAND (HARLAND, 1956). The synclinal structure of the Pipairo complex and the Oshirabetsu dome dealt with in the present paper, reveal to be the identical tectonic facies nevertheless they might be seemed to be different in structure, because it shows that the synclinal structure of the Pipairo complex and dome of the Oshirabetsu body represent the different level of a

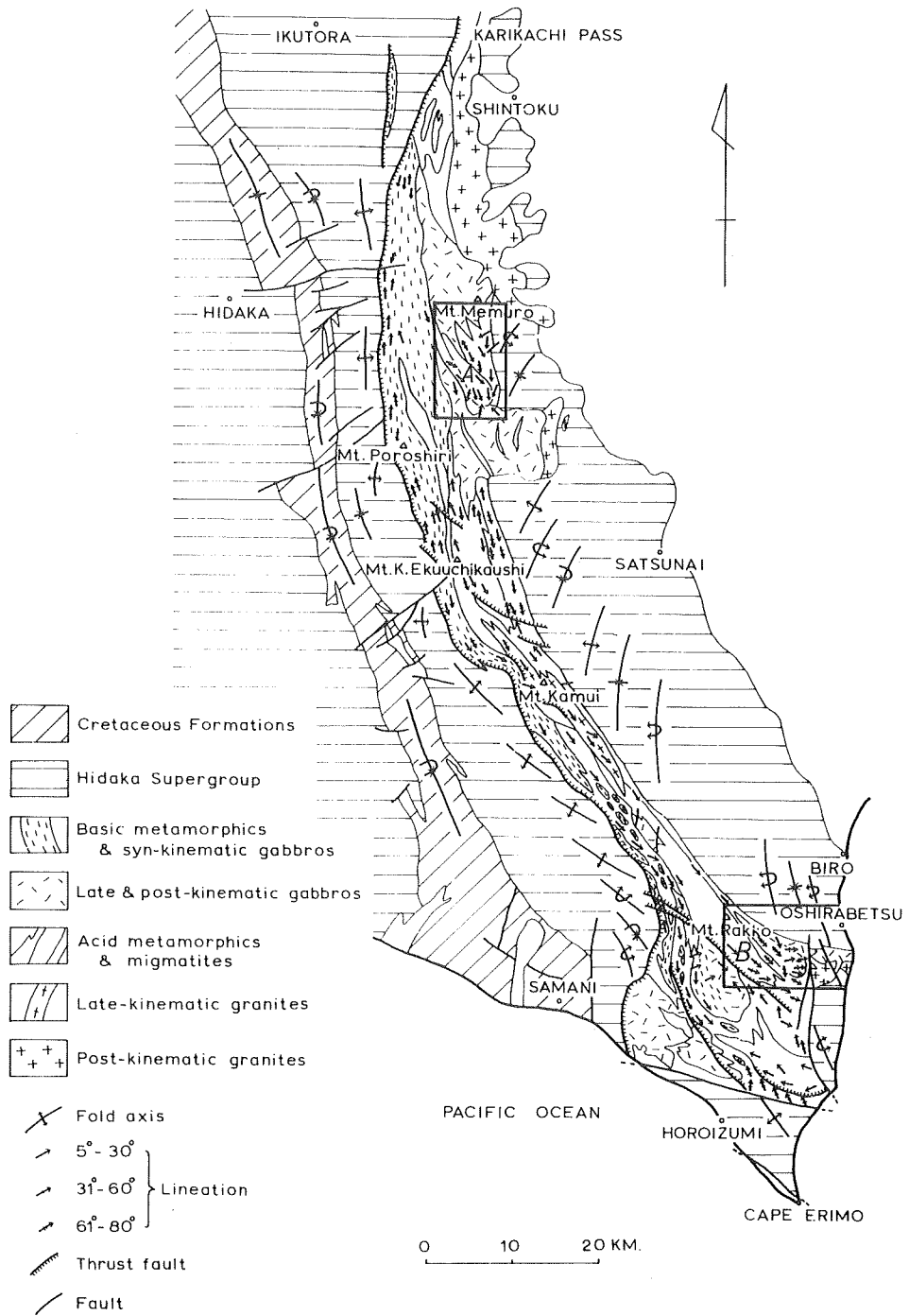

Fig. 1 Tectonic map of the Hidaka metamorphic belt, A: Pipairo complex, B: Oshirabetsu dome.

structure of the same tectonic facies. Furthermore, the direction of the tectonic transport of the structures is also identical toward south that is of the same tectonic style (HARLAND, 1956). Therefore, the tectonic configuration of the structure from the view point of structural level is quite probable to be a sort of diapir of the migmatite in the metamorphic belt.

Pipairo Complex (Fig. 2 and 3)

The Pipairo complex has been seemed simply to be a mass of gneissose granite called the Pipairo gneissose granite. The complex is, however, composed of the biotite gneiss and biotite migmatite which form a synclinal basin structure of 9 km long and 3 km wide at the center and the coarse granitic migmatite of anatexitic nature revealing three sheet structures or steeply inclined phacoliths at the eastern side.

The complex situated at the north-eastern part of the Hidaka metamorphic belt, contacts to the schistose biotite hornfels with faults or sheared zone in between. Further east, it transits to the slates and sandstones of the Hidaka supergroup, presumably of the lower Mesozoic in age. It is surrounded by the gabbros to north, west and south.

The eastern side of the Hidaka metamorphic belt generally represents a series of progressive metamorphism of the high temperature and low pressure type from the sediments of the Hidaka supergroup to be various types of migmatites via biotite hornfels, schistose biotite hornfels and banded biotite gneiss. In the area in question, the zone of the banded biotite gneiss is missing and also the most granitized portions, i.e. anatexites of the granitic migmatites, occur on the eastern side. A number of gabbro sheet in the migmatite aureole separates the structural subunits which are the synclinal basin and phacolith structures. The gabbros are acidified to be dioritic, granodioritic rocks by migmatization and are scattered in the migmatites as paleosomes. The gabbros at the northern portion interfinger and contaminate with the migmatites so that the boundary between them is obscured. The schistose biotite hornfels and banded biotite gneiss on the western side of the synclinal structure are the continuation of the septum between gabbro masses from the north and envelope the synclinal structure at the southern end. A small sheet of granite is observed on the eastern flank of the syncline and its petrographic nature is quite similar to that of the postkinematic granites which are seen at the northern region of the belt (Fig. 1).

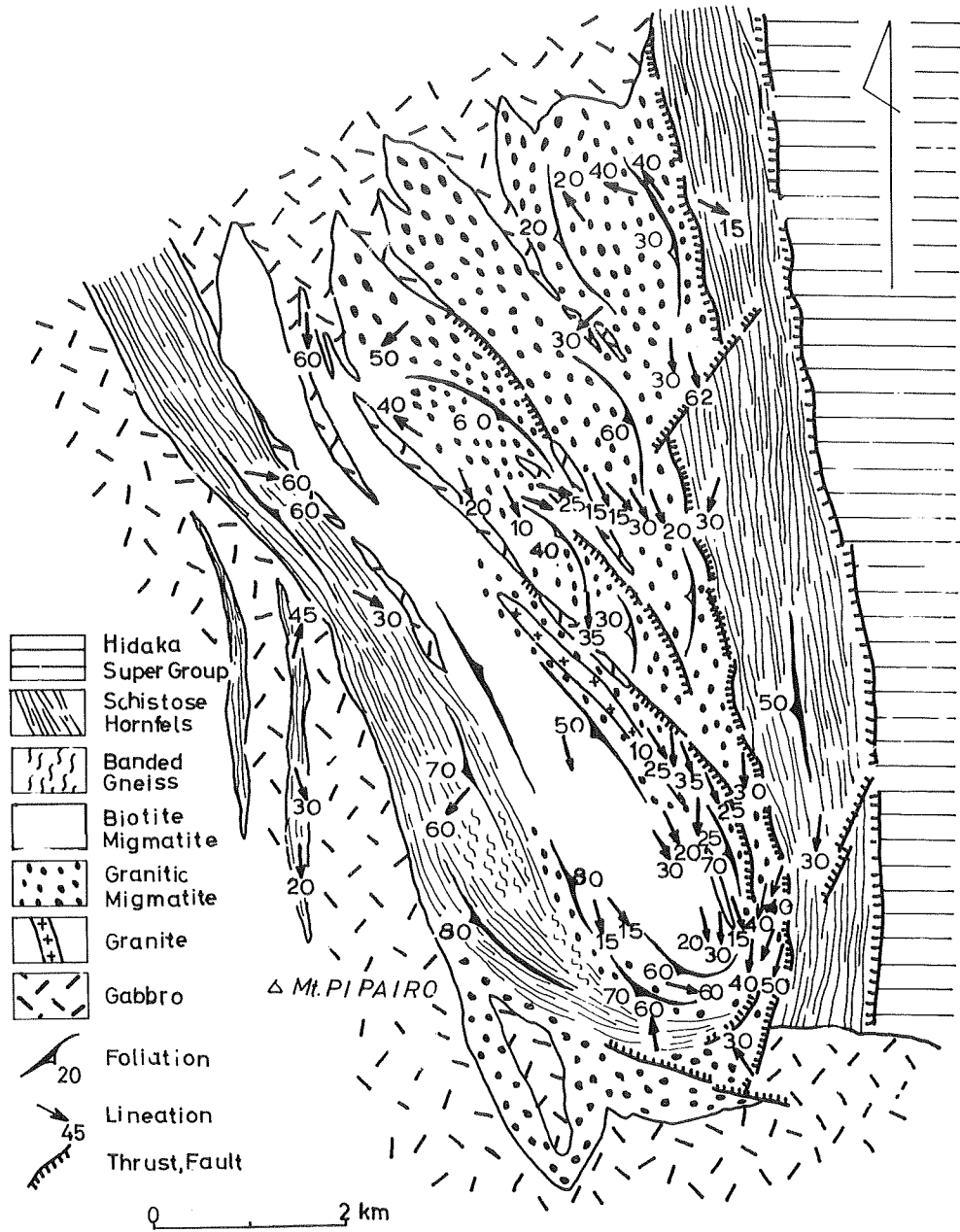

Fig. 2 Tectonic map of Pipairo complex.

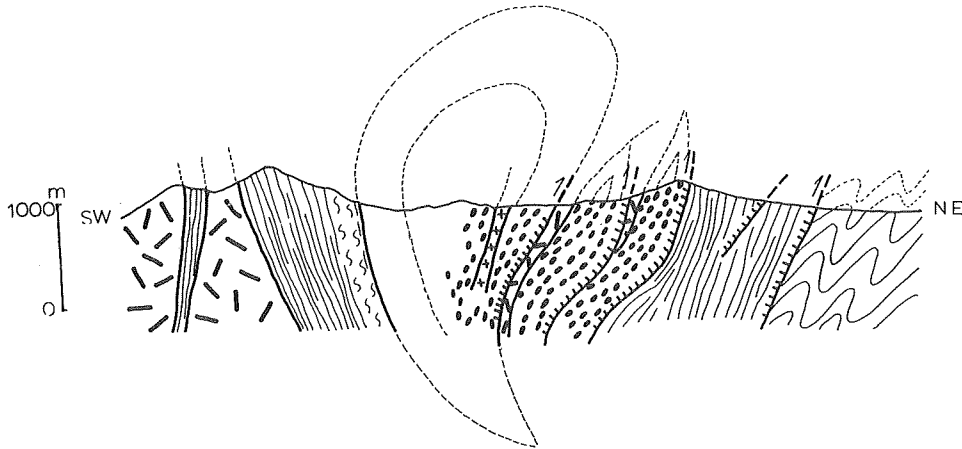

Fig. 3 Cross section of Pipiro complex.

Structures

Foliation: Foliation is signified by the planar arrangement of biotite flakes and the compositional alternation of biotite-rich layers and quartz – feldspathic layers emphasizes the foliation. The foliation is weakened in the migmatized portion and then the massive migmatites are observed in some locations. The general trend of the foliation indicates the direction of $N 20^{\circ} W$ though the local variation is significant because of the complexed structure.

The inclination of the schistose biotite hornfels and banded biotite gneiss on the western side changes from east on the north vertical to south-west on the southern end where the strike turns toward east-west enveloping the migmatite core. The migmatite core indicates a syncline at the central portion, while a monoclinic structure inclined to west suggests a dome structure at the southern portion. The β diagram in Figure 4 shows an incomplete synclinal structure with monoclinic tendency. The β maximum coincides to the maximum in the orientation pattern of the lineation of the structure (Fig. 5), therefore, the lineation signifies the b-lineation. This structural pattern attributes to the same tectonic facies as that of the Oshirabetsu dome of the southern extreme region of the belt.

Three phacolith structures occupy the eastern side of the synclinal one which are separated by the narrow gabbro sheets. The phacolith sheets of granitic migmatite are overlapping one another dipping gently toward west at the inside, while steeply at the outside and bounded by thrust faults associated with occasional gabbro sheets. These phacolith sheets, therefore, are seemed to be thrusting up toward east resulting in the structure above mentioned. A granitic migmatite arch is found on the north-eastern side of the complex

where the foliation inclines gently to west with monoclinic tendency but the distribution of the lineation indicates the arch structure. The β diagram of these phacolith structures (Fig. 6) shows the monoclinic and the presence of two maxima suggests that these sheet structures should be arches basically as shown by the north-eastern arch (Fig. 2).

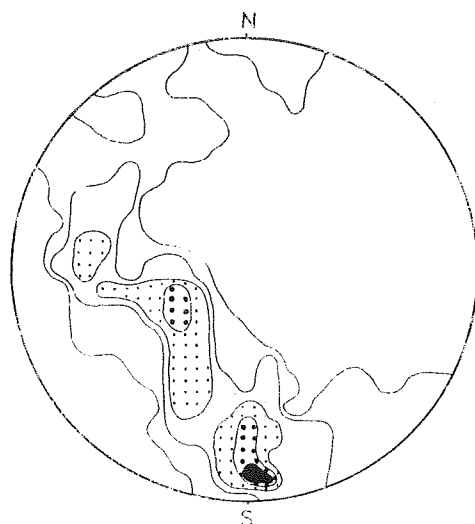

Fig. 4 β diagram of the synclinal structure of Pipairo complex.

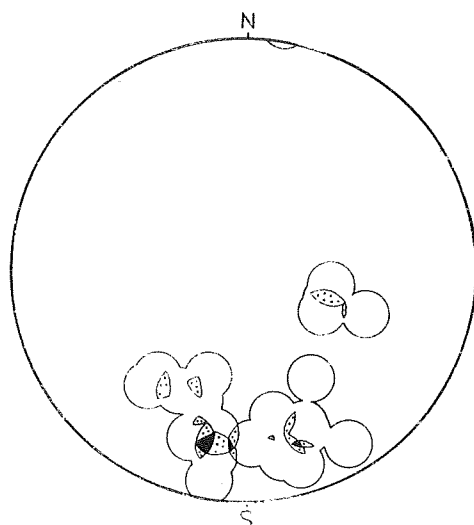

Fig. 5 Lineation diagram of the synclinal structure of Pipairo complex.

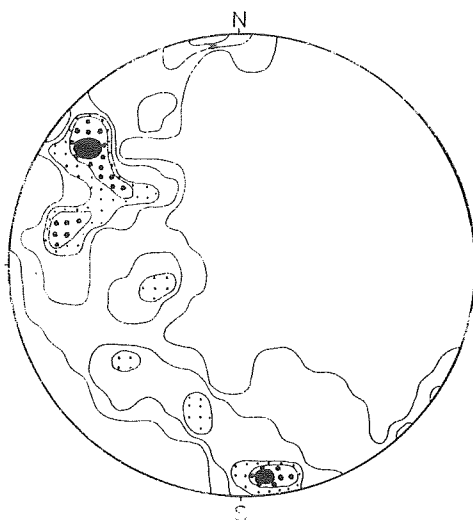

Fig. 6 β diagram of the phacolithic structure of Pipairo complex.

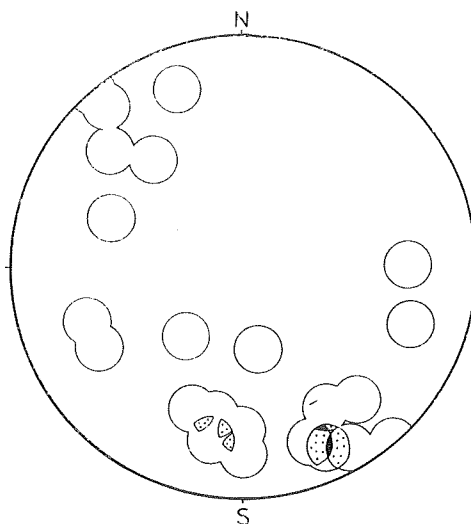

Fig. 7 Lineation diagram of the phacolithic structure of Pipairo complex.

Lineation: Lineation is represented by the linear arrangement of biotite flakes on the foliation and the axis of micro-undulation of the foliation both of which are generally parallel each other. It is clear that the lineation is the b-lineation from the β diagram as well as field observations (Fig. 5 and 7). The lineation inclines generally to south although some to north in the arches. The principal direction of tectonic transport of the complex particularly on the synclinal structure, should be toward south upward. This movement picture due to the lineation shows a good accordance with that by the pattern from the

foliation.

Marked overthrust round the southern end of the synclinal structure where the migmatites are crushed to reveal mylonitic texture under the microscope. This should be another evidence for the movement direction of the structure toward south. However, the direction of the tectonic transport of the phacoliths are generally toward east upward accompanied with southward element. It is suggested by the β and lineation diagrams that the β maxima and lineation of the sheets indicate the cooperation with the synclinal structure moving toward south, while they move up toward east associated with overthrusting.

The Pipairo complex hence seems to show two sorts of different tectonic facies but the deformation history is more complicated in detail.

The trend of N 20° W with the inclination to eastward which is the general trend of the metamorphic belt, is observed at the northern portion of the synclinal structure that forms "Falling star". Then, the acute syncline appears in the central portion and the monoclinic structure inclined toward west occupies the head of the "Falling star". The sequence of the deformations of the complex is divided into three stages as follows;

- 1) Synkinematic stage I. The general trend of the structure of N 20° W with eastward dipping.
- 2) Synkinematic stage II. The southward flow forming "Falling star".
- 3) Latekinematic stage I. The eastward upthrusting phacolithic sheets of granitic migmatite and its anatexites.

Oshirabetsu Dome (Fig. 8 and 9)

The Oshirabetsu dome locates the eastern part of the southern extreme region of the Hidaka metamorphic belt and show a characteristic shape like "Falling star" on the surface plane which indicates quite resemblance to the surface pattern of the synclinal structure of the Pipairo complex in shape and scale.

The core portion of the dome composed mainly of cordierite migmatite and is surrounded by the banded biotite gneiss. The dome with 3 km wide at the main portion, extends to north-west forming the trail of the "Falling star" which reduces the width out within 10 km with monoclinic inclination to east.

The structural study of the Oshirabetsu dome with special references to petrofabric analysis has been carried out by the present author (KIZAKI, 1956). The rearrangement of the data with new informations having obtained since then, is performed for the present study on the problem of the migmatite tectonics.

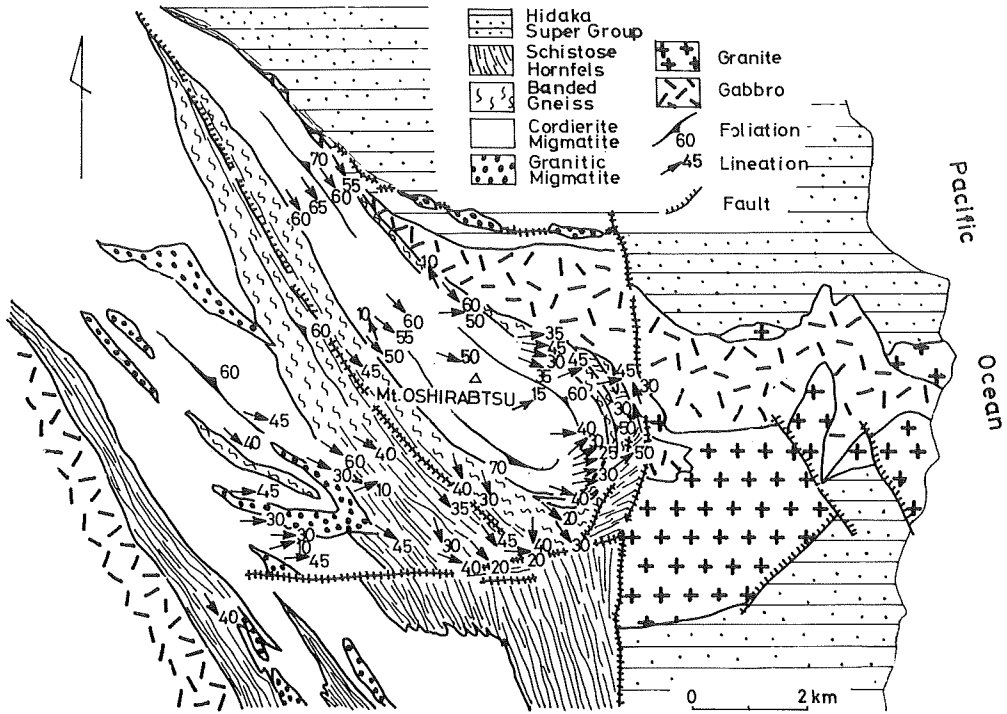

Fig. 8 Tectonic map of Oshirabetsu dome.

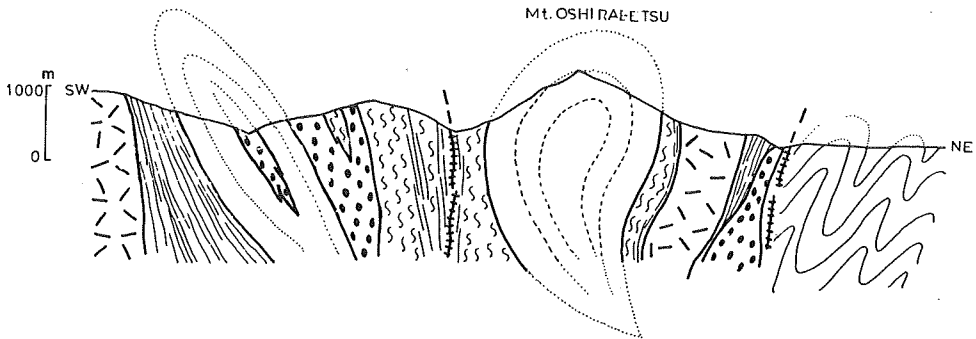

Fig. 9 Cross section of Oshirabetsu dome.

A gabbro body on the north-eastern side of the dome, separates the biotite hornfels zone distributed outside. The linear arrangement of small granitic migmatite sheet occurs along the sheared zone in the hornfels aureole. On the eastern side of the dome, the gabbro and granite bodies are separated by schistose biotite hornfels accompanied with sheared zone and thrust fault. The schistose biotite hornfels, banded biotite gneiss and cordierite migmatite which

are separated by sheared zone are among the other tectonic units of the core of the belt on the south-western side.

Structure

Foliation: The foliation is defined in the above chapter. The π diagram in Figure 10 shows one single maximum S_1 and great circle girdle including submaximum S_d . These signify that two sorts of structure are involved: S_1 indicates the general trend of the metamorphic belt while the great circle girdle represents the foliation of the main portion of the dome on the south-eastern part. It is further clear in the β diagram that a later deformation is superimposed on the "Falling star" structure because two great circle girdles are crossed each other in Figure 11. The great circle girdle which includes the maximum β_1 corresponds to S_1 while the girdle with β_d to S_d in which the latter concerns the movement of the main dome formation in the later stage than the former which is the movement associated with the formation of the general trend of the belt.

The superimposed deformation of the Oshirabetsu dome can be separated from the earlier deformations of which the original monoclinic structure and southward flow parallel to the general trend of the belt: the synkinematic stage I and II, is succeeded by the up-doming toward east-south east at the main portion: the latekinematic stage. The discrimination of the latekinematic stage from the synkinematic one is more certain in the Oshirabetsu dome area than in the Pipairo synclinal structure because of the shallower level of the tectonics.

Lineation: The distribution of the lineation reveals the coincidence to the β_d girdle though there is an indication to the β_1 girdle. It suggests that the majority of the lineation could be oriented due to the doming that is at the latekinematic stage (Fig. 12).

Deformation of paleosomes: Many paleosomes in the cordierite migmatite which shows the agmatic and schollen structures are scattered having the banded biotite gneiss and schistose biotite hornfels in composition. Many of them show various grade of rotational patterns in shape (KIZAKI, 1956), which suggest that the migmatite flows under the elasto-plastic conditions of the almandine amphibolite facies so that the paleosomes rotate as the result of the differential flow of the migmatite. The rotational pattern of each paleosome, therefore, should represent the direction of the partial movement on the point where the paleosome rotates and then the sum total of the partial movement, would configure the movement picture of the dome.

Actually, most of the paleosomes rotate on the plane normal to the lineation i.e. (ac) plane, while some do on the plane (bc) parallel to the

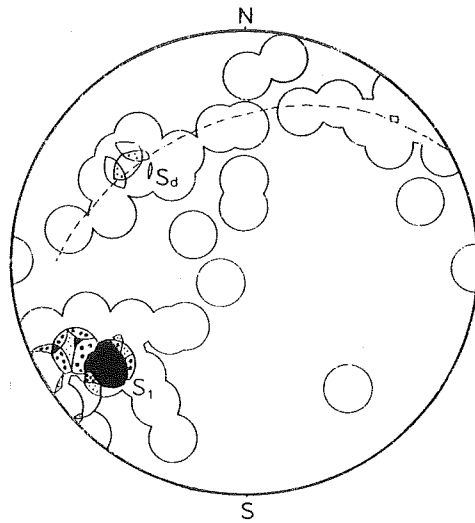

Fig. 10 π diagram of Oshirabetsu dome. S_1 indicates the foliation pole of the general trend of the belt and S_d shows the foliation of the dome.

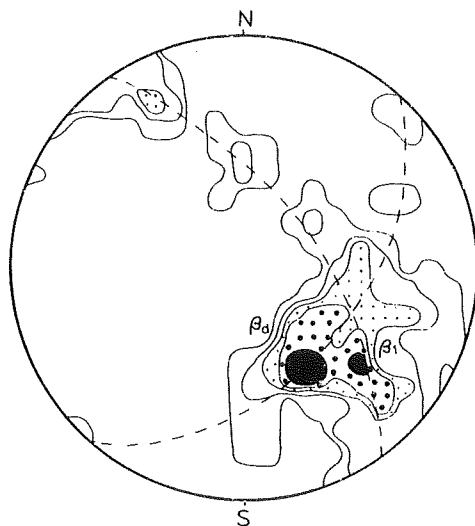

Fig. 11 β diagram of Oshirabetsu dome. β pole signifies the general trend while β_d does the dome.

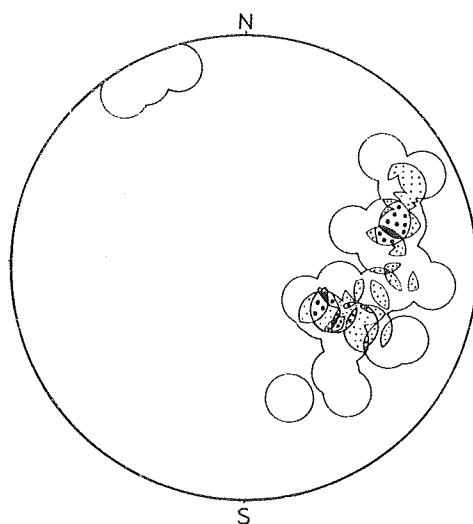

Fig. 12 Lineation diagram of Oshirabetsu dome.

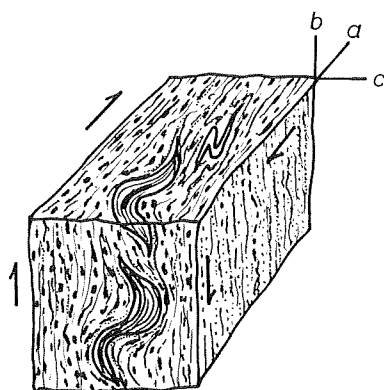

Fig. 13 Triclinic deformation of paleosome.

lineation. It is sometimes observed that the rotations both on the (ac) and (bc) planes occur on one specimen (Fig. 13). This is clearly superimposed structure which is also revealed by the petrofabric analysis (op. cit.). The distribution of quartz axes shows mainly (ac) girdle with symmetry to the b-axis but some tendency toward (bc) girdle which is believed to be a relict fabric because the movement symmetry to the b-axis should be the result of the later and main doming upward. Therefore, the sequence of deformation can be clarified as to the earlier monoclinic structure from the later dome structure.

Now, when every rotational direction of each paleosome is compiled on the map of its location, it is then found that the direction of the rotation on each

side is reverse (Fig. 14). It is therefore, evident that the center of the dome moves differentially up faster than the outer portion of it resulting in the rotation of the paleosomes. The direction of the tectonic transport of the dome is then to be normal to the b-axis, being about 40 degrees upward to east-south east.

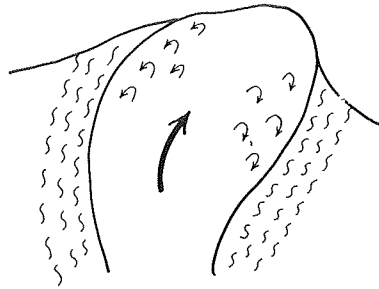

Fig. 14 Differential upward movement of Oshirabetsu dome due to the rotation of paleosomes.

Configuration of Diapir

It is now evident that the synclinal structure of the Pipairo complex and Oshirabetsu dome attribute to the same tectonic facies and style of which the reasons are as follows;

- 1) Shape is similar like "Falling star"
- 2) Scale is just identical each other: 3 km wide at the main portion and 10 km long.
- 3) Composition is migmatites of agmatic, schollen and nebulitic nature.
- 4) Direction of tectonic transport is toward south upward at the synkinematic stage II and afterward turns toward east at the latekinematic stage.
- 5) Granitic migmatites occur on the eastern outside of the dome more or less.
- 6) Both are related to gabbro and granite.
- 7) Southern end of the dome is bounded by overthrusting fault.

Therefore, the structure can be comprized as a diapir of which the synclinal structure of the Pipairo complex should be the lower level and the Oshirabetsu dome the upper level. The geological and structural environments indicate the good accordance with it when the configuration is carried out as shown in the vertical section (Fig. 15). The structure is not the diapir *sensu stricto* but the embrionic stage of it, advanced pillow structure by TRUSHEIM (TRUSHEIM, 1960), evidenced by the latekinematic up-doming of the Oshirabetsu dome. As analysed in the above chapter, the south-east south movement of the synkinematic stage have turned upward in the direction of east-south east at

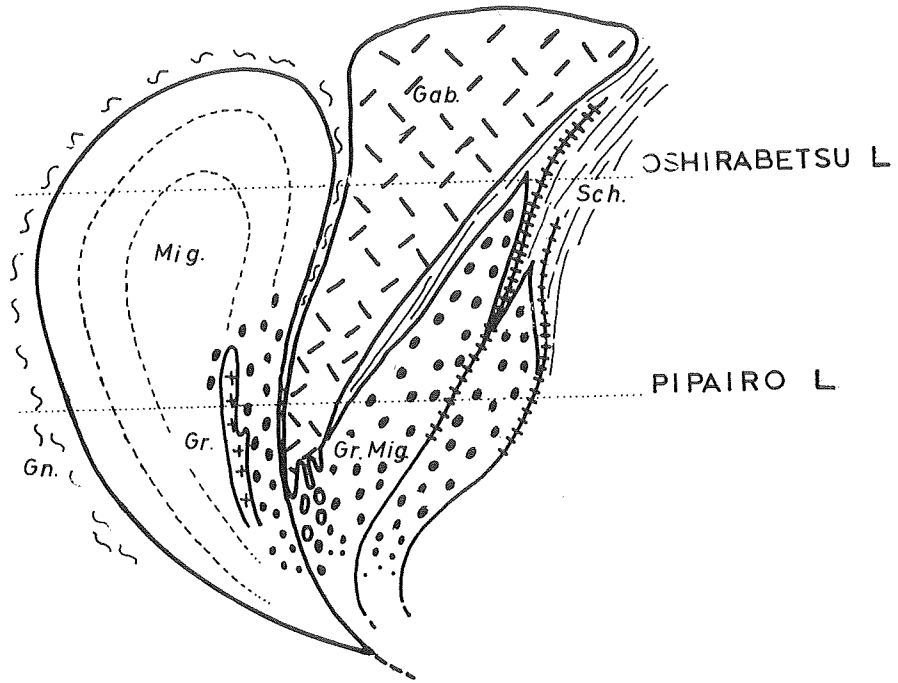

Fig. 15 Configuration of the dome in the vertical section.

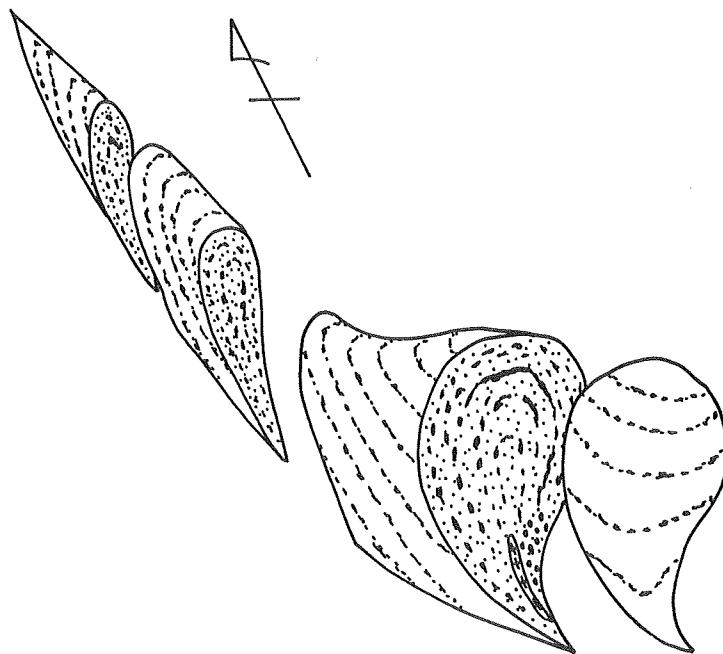

Fig. 16 Three dimensional form of the dome.

the latekinematic stage. It signifies that the tangential stress had been predominant at the synkinematic stage and then the up-doming process would have been succeeded at the latekinematic stage. Thus, it should be noticeable that the southward flow of the migmatites on the eastern side of the metamorphic belt had occurred at the synkinematic stage II equivalent to that of the Pipairo complex from the tectonic view point.

It could suggest particularly to be involved in a wrench fault tectonics in the deeper level because the migmatite bodies on the western side moved northward against the structures in question though it is not sharp as on the eastern side (KIZAKI, 1964a).

Appendix

The configuration produces the three dimensional picture of the structure of "Falling star" that has 10 km long and 3 km wide at the main portion with 4 km deep. Therefore, the volume of the "Falling star" is to be calculated approximately as 43.4 km³.

The upward velocity of the "Falling star" or dome should be calculated by using the STOKES' LAW without considering any other functions.

$$V = \frac{2}{9} \cdot \frac{g \cdot r (d' - d)}{\eta}$$

$d' = 2.80$: the average density of the sediments of the Hidaka supergroup, $d = 2.73$: the average density of the cordierite migmatite, r is the radius of the dome. η is the viscosity of cordierite migmatite that is the problem to be remained. If the $\eta = 10^{21}$ is taken, the upward velocity of the dome should be $V = 0.23 \text{ mm yr}^{-1}$. The figure corresponds to the velocity of the epeirogenetic movement as well as the velocity of the diapir movement of salt mass by TRUSHEIM (op. cit.). Therefore, it might be reasonable so far as it is concerned.

The upward velocity of the migmatite dome, however, should be more than that figure because the value of it should be smaller than 10^{21} due to the higher temperature of the core of the metamorphic belt and also the tectonic force should be another function to be considered.

Acknowledgement

The author is grateful to Professor T. ISHIKAWA for his encouragement and helping throughout the various stages of this study. Thanks are due particularly to his colleagues of Messrs H. TANAKA, K. NIIDA and T. UDA for helping the preparation of the manuscript.

References Cited

- HARLAND, W.B. (1956): Tectonic Facies, Orientation Sequence, Style and Date, *Geol. Mag.* **93**, 111 – 120.
- HIROTA, S. (1963): Granitization in the Horoman District, Southern Part of the Hidaka Metamorphic Zone (1), *Jour. Geol. Soc. Japan*, **69**, 82 – 98.
- HUNAHASHI, M., HASHIMOTO, S., ASAI, H., IGI, S., SOTOZAKI, Y., KIZAKI, K., HIROTA, S. and KASUGAI, A., (1956): Gneisses and Migmatites in the Southern Extreme Region of the Hidaka Metamorphic Zone, Hokkaido, *Jour. Geol. Soc. Japan*, **62**, I, 401 – 408, II, 464 – 471, III, 541 – 549.
- HUNAHASHI, M., (1957): Alpine Orogenic Movement in Hokkaido, Japan, *Jour. Fac. Sci. Hokkaido Univ.* **6**, 415 – 464.
- KAWANO, Y. and UEDA, Y. (1967): K – Ar dating on the Igneous Rocks in Japan (VI) – Granitic Rocks, Summary –, *Jour. Petrogr. Miner. Econom. Geol.*, **57**, 177 – 187.
- KIZAKI, K. (1956): Petrofabrics of the Oshirabetsu Dome in the Southern Hidaka Metamorphic Zone, Hokkaido, Japan, *Jour. Fac. Sci. Hokkaido Univ.* **9**, 289 – 317.
- KIZAKI, K. (1964a): Hidaka Orogeny – A Type of Alpine Orogeny – *Proc. Int. Geol. Congress, India, Section 11*, 1 – 16.
- KIZAKI, K. (1964b): On Migmatites of the Hidaka Metamorphic Belt, *Jour. Fac. Sci. Hokkaido Univ.* **12**, 111 – 169.
- TONOZAKI, Y. (1965): Studies on the Hidaka Metamorphic Belt of the Southern Hidaka Mountains, Hokkaido, *Bull. Hokkaido Univ. Education*, **13**, 1 – 98.
- TRUSHEIM, F. (1968): Mechanism of Salt Migration in Northern Germany, *Bull. Am. Assoc. Petrol. Geol.*, **44**, 1915 – 1940.

(Manuscript received August 31, 1971)