



Title	Experimental Studies on Some Combustion Problems of Diesel Engines by the Method of Analysing Indicator Diagrams
Author(s)	Kuroiwa, Tamotsu
Citation	Memoirs of the Faculty of Engineering, Hokkaido University, 10(3), 383-451
Issue Date	1957-09-30
Doc URL	http://hdl.handle.net/2115/37804
Type	bulletin (article)
File Information	10(3)_383-452.pdf



[Instructions for use](#)

Experimental Studies on Some Combustion Problems
of Diesel Engines by
the Method of Analysing Indicator Diagrams

By

Tamotsu KUROIWA

(Received June 30, 1957)

CONTENTS

	Page
Introduction	384
Experimental Apparatus and Fuels	384
1. Experimental engine	384
2. Indicator	385
3. Fuels	388
The Method of Analysing Indicator Diagrams	388
1. The case of an engine with single combustion chamber	388
2. The case of an engine with pre-combustion chamber	389
Experimental Results and Discussion	393
I. Influence of Cetane Value of Fuel on Diesel Engine Performace . .	393
1. Preface	393
2. Performance tests on several types of combustion chamber . . .	395
(i) Description of experiments	395
(ii) Discussion of the experimental results	399
3. Cases when the timing of ignition is changed	402
(i) The case of heavy load	403
(ii) The case of light load	409
4. Conclusions	412
II. Combustion Progress when Pilot Injection is Employed	414
1. Preface	414
2. Experimental method	414
3. Experimental results and discussions	416
4. Conclusions	422
III. Combustion and Performance of a Diesel Engine with	
Pre-Combustion Chamber	424
1. Preface	424
2. Test engine and experimental method	425
3. Experimental results and discussions	426
(i) Influence of the timing of fuel injection	427

(A) Performance curves (comparison to an engine of direct injection type)	427
(B) General discussion of indicator diagrams	430
(ii) Effect of cetane value of a fuel	435
(iii) Throttle valve and pintle valve	441
(iv) Combustion progress in each combustion chamber	444
4. Conclusions	447
Closures	451

Introduction

The most important thing in improving the thermal efficiency of a Diesel engine is to make sure that combustion is completed quickly. In other words, the after-burning should be reduced as far as possible. In Diesel engines, some combustion problems regarding the improvement of their performances can be usually analysed as problems of the degree of this after-burning. The problems regarding the combustion of a Diesel engine are so complicated owing to the problems of fuel injection and the mixing of air and fuel, that they can hardly be analysed by means of only usual fundamental researches. Therefore, this paper is intended to present some solutions, and descriptions which were derived from analysing the process of combustion as recorded on indicator diagrams obtained under operating conditions of a practical engine, concerning the following three subjects.

- I. Influence of Cetane Value of Fuel on Diesel Engine Performance.
- II. Combustion Progress when a Pilot Injection is Employed.
- III. Combustion and Performance of a Diesel Engine with Pre-combustion Chamber.

Experimental Apparatus and Fuels

1. Experimental Engine.

Single cylinder test engine (Fig. 1).

bore : 110 mm, stroke : 140 mm,

rated horse power : 10 BHP at 1400~1500 r.p.m.

This engine is convertible into engines with various combustion chambers by changing its cylinder head and piston.

Cylinder head for direct injection combustion chamber :

4 valves, (2 masked inlets, 2 exhausts).

Cylinder head for pre-combustion chamber :
2 valves.

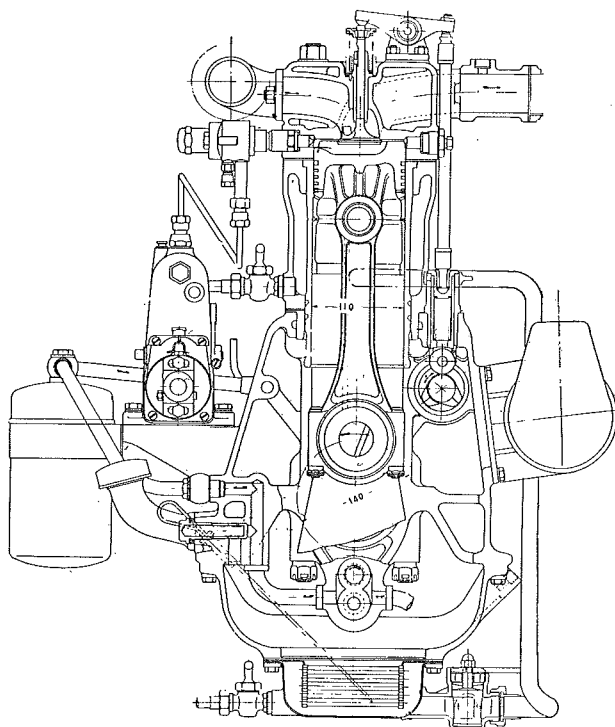

Fig. 1. Experimental Engine.

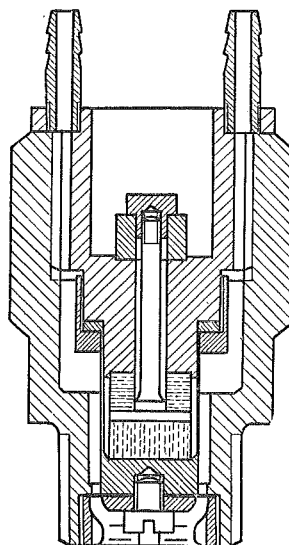

Fig. 2.

Pick-up for Piezo-electric
Indicator.

2. Indicator.

A piezo-electric indicator was employed. A electromagnetic oscillograph was used for the recordings and a cathode ray oscillograph was also used for observations. The structure of the pick-up was of a shell type as shown in Fig. 2. The pressure diaphragm in contact with high temperature gas was made of a thin sheet of phosphor bronze, and any influence of the cyclic change of gas temperature in the cylinder was avoided.

The change of temperature in the inner part of the pick-up containing crystals, however, could not be avoided, since the diaphragm was directly connected with the inner part and its cooling was not sufficient. Accordingly, the disadvantage of changing the sensitivity of the indicator resulted. Therefore, the pressure under any given

operating conditions was first measured by using a Farnborough indicator, and then the sensitivity of the piezoelectric indicator was adjusted by comparing with the readings of the Farnborough indicator.

In the case of an engine with a pre-combustion chamber, pressure indicators were equipped in both chambers, respectively. Since an accurate value of pressure difference between the two combustion chambers was required especially in this case, a device of adjusting the sensitivities of indicators was employed so that they would always coincide each other while the engine was operated.

Besides, the pressure difference between the two combustion chambers was also recorded. As is shown in Fig. 3, the amplifiers of the

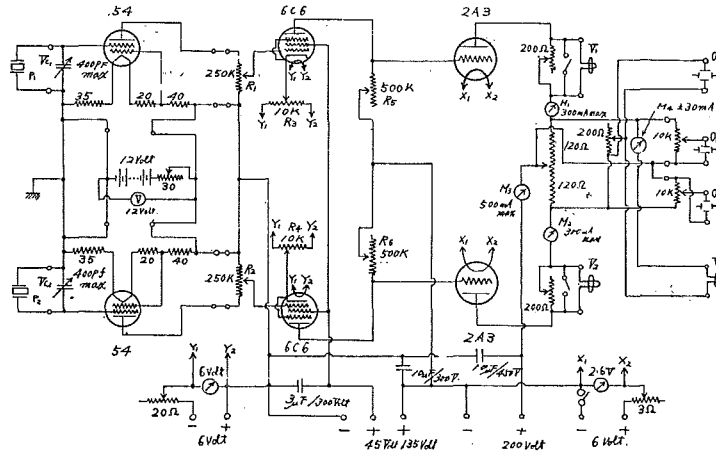

Fig. 3. Diagram of Amplifier for the Measurement of Pressure Difference.

two indicators were put in a cabinet, and the same electrical source was used. A bridge circuit was arranged at the output ends of the two amplifiers so that the difference of the current at their output would be obtained. At first, the amplifiers were adjusted so that the readings of ammeter would be always zero, when the same change of pressure was given at the pick-up. The pressure difference during the operation of an engine, converted into current, was indicated on a Braun-tube, and the sensitivities of indicators were adjusted by changing the capacities of variable condensers set parallel with the pick-up, when ever the image on the tube was judged to be unreasonable. Furthermore, the coincidence of the sensitivities of indicators was

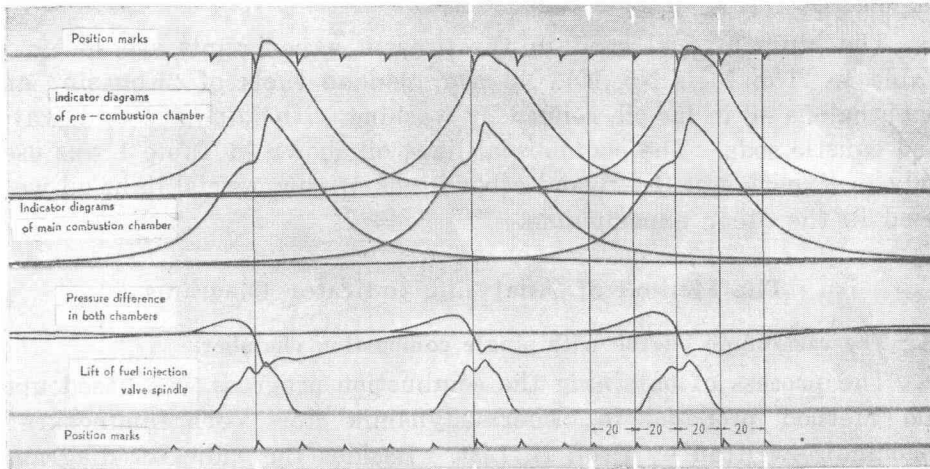

Fig 4. Indicator Diagrams of Experiment (IX)-D in Study III.

sometimes assured by checking if the image of pressure difference on the Braun tube deviated from a straight line or not after the engine was warmed up, since the pressure difference between the two chambers must be approximately zero when the engine is operated at about 200 r.p.m. An example of the oscillogram of an engine with pre-combustion chambers is shown in Fig. 4.

Table I Properties of Fuels

FUELS	Kogasin	N 4	N 5	N 3	Commercial Light Oil	Secondary Reference Fuel S.R.F. 60	Secondary Reference Fuel S.R.F. 30
Specific Gravity 15/4°C	0.763	0.901	0.881	0.938	0.846	0.800	0.855
Viscosity 30°C	31.6s	31.0	30.8	33.0	—	32.0	33.0
R.W. 50°C	29.8s	29.0	29.0	—	—	—	—
Freezing Point °C	-7.5	-16.5	-17.5	-18	—	-23	-31
Flash Point °C	71.5	76	75	79	—	68	525
Aniline Point °C	86.3	38.8	47.2	28	—	86.1	60.1
Residual Carbon %	trace	0.03	0.03	—	—	—	—
Sulphur Content %	trace	0.36	0.30	0.40	—	0.05	0.05
Higher Calorific Value Hz %	11350	10350	10560	9800	10200	11000	10700
	14.7	9.5	10.5	9.2	(14)	(14)	128.2
Initial Boiling Point °C	190	190	192	189	139	176	159
Dry Point °C	324	321	328	320	302	304	295
Index of Boiling Point °C	242	239	240	237	220	248	246
Cetane Number	82	42	48	28		60	30

3. Fuels.

The kinds of fuel used in the present experiments are shown in Table 1. The fuels N5, N4, N3 are blended fuels of "Kogasin" and naphthalene oil in tar oil, refined by washing with sulphuric acid, water and caustic soda. The commercial light oil shown in Table 1 was used only in Experiment (I-2), and other kinds of commercial light oil were used in the other experiments.

The Method of Analysing Indicator Diagrams

1. The case of an engine with single combustion chamber.

The process of obtaining the combustion progress was based upon the method proposed in "Thermodynamik der Verbrennungskraftmaschinen" written by Prof. H. List. Besides the indicator diagrams, the volume of suction air was measured, and it was assumed that the volume of residual gas was $1/2r$ of the volume of suction air, (taking r as the compression ratio).

The energy equation in respect to 1 Mol of working medium in a compression stroke is as follows, between a certain point before the beginning of combustion and an arbitrary point during the combustion period:

$$(\delta_\alpha \cdot u_\alpha - u_0) + AL_{0-\alpha} + Q_{w_{0-\alpha}} = H_\alpha$$

where,

- H_α = Heat generated by combustion
- $AL_{0-\alpha}$ = External work done
- δ_α = Change of number of Mols before and after the combustion
- u_α = Internal energy of working medium in combustion period
- u_0 = Internal energy of working medium before combustion
- $Q_{w_{0-\alpha}}$ = Cooling loss.

Each of these terms can be obtained in the following manner from the indicator diagram and the weight of working medium:

	known value	measured value	
--	-------------	----------------	--

$$\begin{array}{l}
 V_0 \qquad p_0, G \qquad \longrightarrow \qquad T_0 = \frac{p_0 V_0}{R_{\text{air}} G} \qquad \longrightarrow \qquad u_0 \\
 \\
 V_\alpha \qquad p_\alpha, G_{g\alpha} = G + G_{f\alpha} \longrightarrow T_\alpha = \frac{p_\alpha V_\alpha}{R_{g\alpha} G_{g\alpha}} = \frac{p_\alpha V_\alpha}{\delta_\alpha R_{\text{air}} G} \longrightarrow u_\alpha
 \end{array}$$

where,

$$\begin{aligned} G &= \text{Weight of working medium in compression period} \\ G_{g\alpha} &= \text{Weight of working medium in combustion period} \\ G_{f\alpha} &= \text{Weight of injected fuel.} \end{aligned}$$

δ_α is unknown until the computation is completed. Therefore, the cases of assuming air and complete combustion gas as the working medium were calculated respectively at first, and the values of δ_α were interpolated.

That is to say, when it is assumed that the working gas is air,

$$T_{\alpha_{\text{air}}} = \frac{p_\alpha V_\alpha}{R_{\text{air}} G} \longrightarrow u_{\alpha_{\text{air}}}$$

Further, when it is assumed that the working medium is complete combustion gas,

$$T_{\alpha_{\text{gas}}} = \frac{p_\alpha V_\alpha}{\delta R_{\text{air}} G} \longrightarrow u_{\alpha_{\text{gas}}}$$

δ = Change of number of Mols before and after the combustion of all injected fuel.

External work is

$$L_{0-\alpha} = \sum L_{1-2} = \sum \left[\frac{p_1 V_1 - p_2 V_2}{n-1} \right] \quad \text{or} \quad \sum \frac{p_1 + p_2}{2} (V_2 - V_1)$$

n = Index of polytropic change between 1 and 2 obtained from indicator diagram.

The numerical computations of the above integration were performed at the interval of $1^\circ \sim 2^\circ$ in crank angle for the main combustion period, and at the interval of $2^\circ \sim 5^\circ$ for the after-burning period.

Since the estimation of cooling loss is difficult, it was not taken into consideration in the present paper. Accordingly, the amount of cooling loss is not included in the generated heat calculated.

2. The case of an engine with pre-combustion chamber.

When the combustion chamber is divided into two chambers connected by narrow passages, there exists a considerable pressure difference between the two chambers. Accordingly, the progress of combustion in each combustion chamber can be obtained from the respective indicator diagrams in the same manner as the case of single

combustion chamber, when the amount of working medium moving between the two chambers is obtained with the aid of this pressure difference.

The state (temperature) of the working medium in both chambers before the beginning of combustion and the degree of transformation of the kinetic energy of flow into heat must first be obtained for the computations of the each progress of combustion. The former may be assumed as will be described below, and the latter was assumed on the basis that the energy of flow during the combustion period changes into heat at the instant of entrance. Under these assumptions, if the cooling loss could be left out of consideration, one can obtain the following energy equation between two points of combustion :

pre-combustion chamber ;

$$\begin{aligned} p_z > p_v & \quad G_{v_1} \cdot u_{v_1} + \Delta G_{1-2} \cdot i_{z_{1-2}} + H_{v_{1-2}} = G_{v_2} \cdot u_{v_2} \\ & \quad H_{v_{1-2}} = (G_{v_2} \cdot u_{v_2} - G_{v_1} \cdot u_{v_1}) - \Delta G_{1-2} \cdot i_{z_{1-2}} \\ p_z < p_v & \quad G_{v_1} \cdot u_{v_1} - \Delta G_{1-2} \cdot i_{v_{1-2}} + H_{v_{1-2}} = G_{v_2} \cdot u_{v_2} \\ & \quad H_{v_{1-2}} = (G_{v_2} \cdot u_{v_2} - G_{v_1} \cdot u_{v_1}) + \Delta G_{1-2} \cdot i_{v_{1-2}} \end{aligned}$$

main combustion chamber ;

$$\begin{aligned} p_z > p_v & \quad G_{z_1} \cdot u_{z_1} - \Delta G_{1-2} \cdot i_{z_{1-2}} - AL_{1-2} + H_{z_{1-2}} = G_{z_2} \cdot u_{z_2} \\ & \quad H_{z_{1-2}} = (G_{z_2} \cdot u_{z_2} - G_{z_1} \cdot u_{z_1}) + \Delta G_{1-2} \cdot i_{z_{1-2}} + AL_{1-2} \\ p_z < p_v & \quad G_{z_1} \cdot u_{z_1} + \Delta G_{1-2} \cdot i_{v_{1-2}} - AL_{1-2} + H_{z_{1-2}} = G_{z_2} \cdot u_{z_2} \\ & \quad H_{z_{1-2}} = (G_{z_1} \cdot u_{z_1} - G_{z_2} \cdot u_{z_2}) - \Delta G_{1-2} \cdot i_{v_{1-2}} + AL_{1-2} \end{aligned}$$

where,

suffix z = Notation of main combustion chamber

suffix v = Notation of pre-combustion chamber

p = Pressure in combustion chamber

u = Internal energy

i = Enthalpy

G = Weight of working medium in each combustion chamber

ΔG_{1-2} = Weight of working medium which was moved between two points 1 and 2

AL_{1-2} = External work done by piston

H_{1-2} = Heat generated by combustion.

- (i) Assumption of temperature of working medium before the beginning of combustion in both combustion chambers.

The change of state of working medium in main combustion chamber can be expressed as $pv^n = \text{const.}$ in compression stroke. In the pre-combustion chamber, however, this equation can not be exactly applied because the kinetic energy transformed into heat by friction is irreversible. However, the amount of heat generated may be very small, and the change of state in pre-combustion chamber is assumed to be reversible. Then,

$$p_z v_z^{n'} = \text{const.}, \quad T_z = T_{z_0} \left(\frac{p_z}{p_{z_0}} \right)^{\frac{n'-1}{n'}}$$

$$p_v v_v^{n''} = \text{const.}, \quad T_v = T_{v_0} \left(\frac{p_v}{p_{v_0}} \right)^{\frac{n''-1}{n''}}$$

If it is assumed that the conditions at the beginning of compression are $p_{z_0} = p_{v_0}$, $T_{z_0} = T_{v_0}$, and that $n' = n'' = n$,

$$\frac{T_v}{T_z} = \left(\frac{p_v}{p_z} \right)^{\frac{n-1}{n}} \equiv \alpha$$

From the condition that the sum of the quantities of the working medium in both chambers is constant, one has

$$G = \frac{p_z V_z}{RT_z} + \frac{p_v V_v}{RT_v} = \frac{p_z V_z + \frac{1}{\alpha} p_v V_v}{RT_z}$$

Accordingly

$$T_z = \frac{p_z V_z + \frac{1}{\alpha} p_v V_v}{RG}$$

$$T_v = \alpha T_z$$

The mean value of the index n , between the two points at the beginning of compression and just at the beginning of combustion, was found from the mean compression-pressure line $\left(p_m = \frac{p_z V_z + p_v V_v}{V_z + V_v} \right)$ obtained on the indicator diagrams of both combustion chambers. The value of n was 1.32~1.33 when the beginning point of combustion was $5^\circ \sim 10^\circ$ before the top dead center; $n = 1.325$ was used in all cases of computations.

(ii) Steps of computation.

The starting point of computation was selected at a certain point

before the beginning of combustion and the state at that point was first assumed. Regarding the second point to be determined, the temperature at the side of higher pressure was assumed and $\Delta G_{z_1-z_2}$ or $\Delta G_{v_1-v_2}$ was found. The deduction of $\Delta G_{z_1-z_2}$ or $\Delta G_{v_1-v_2}$ from G_{z_1} or G_{v_1} then gave G_{z_2} or G_{v_2} , and T_{z_2} or T_{v_2} can be obtained with the aid of the equation of perfect gas. When this result does not coincide with the initial assumption, the same process must be repeated. However, two times of trials were sufficient to obtain accuracy within 1°C.

The details of computation are as follows for the case of $p_z > p_v$:
 known quantities. calculated quantities.

$$(1) \left. \begin{matrix} p_{z_1}, p_{v_1} \\ V_{z_1}, V_{v_1} \\ T_{z_1}, T_{v_1} \end{matrix} \right\} \rightarrow \begin{matrix} G_{z_1} = \frac{p_{z_1} V_{z_1}}{RT_{z_1}} \\ G_{v_1} = \frac{p_{v_1} V_{v_1}}{RT_{v_1}} \end{matrix} \text{ and } \left(\frac{dG}{d\alpha} \right)_1$$

$$(2) \left. \begin{matrix} p_{z_2}, p_{v_2} \\ V_{z_2}, V_{v_2} \\ T_{z_2} \text{ assumed} \end{matrix} \right\} \dots \dots \dots \rightarrow \left(\frac{dG}{d\alpha} \right)_2$$

$$\downarrow$$

$$\Delta G_{z_1-z_2} = \frac{1}{2} \left\{ \left(\frac{dG}{d\alpha} \right)_1 + \left(\frac{dG}{d\alpha} \right)_2 \right\} \Delta\alpha$$

$$\downarrow$$

$$G_{z_2} = G_{z_1} - \Delta G_{z_1-z_2}, \quad G_{v_2} = G_{v_1} + \Delta G_{z_1-z_2}$$

$$\downarrow \qquad \qquad \qquad \downarrow$$

$$T_{z_2} = \frac{p_{z_2} \cdot V_{z_2}}{R \cdot G_{z_2}}, \quad T_{v_2} = \frac{p_{v_2} V_{v_2}}{R \cdot G_{v_2}}$$

(iii) Quantity flowing through the connecting passage.

When $p_z > p_v$ and $\frac{p_v}{p_z} > \left(\frac{2}{k+1} \right)^{\frac{k}{k-1}}$,

$$\frac{dG}{d\alpha} = \frac{\rho f}{6n} \frac{p}{\sqrt{RT_z}} \sqrt{2g \frac{k}{k-1} \left\{ \left(\frac{p_v}{p_z} \right)^{\frac{2}{k}} - \left(\frac{p_v}{p_z} \right)^{\frac{k+1}{k}} \right\}}$$

putting

$$\frac{\rho f}{6n} \frac{1}{\sqrt{R}} \sqrt{2g \frac{k}{k-1}} \equiv C$$

one has

$$\frac{dG}{d\alpha} = C \frac{p_z}{\sqrt{T_z}} \sqrt{\left(\frac{p_v}{p_z} \right)^{\frac{2}{k}} - \left(\frac{p_v}{p_z} \right)^{\frac{k+1}{k}}}$$

- f = Sectional area of the connecting passage = 0.000431 m²
 n = r.p.m. of the engine = 1390 (constant)
 μ = Coefficient of discharge = 0.92
 R = Gas constant of the working medium = δR_{air}
 $\quad = 1.039 \times 29.27 = 30.41 \text{ m kg/}^\circ\text{C kg}$ for $\lambda = 1.8$ (full load),
 $\quad \quad 1.021 \times 29.27 = 29.83 \text{ m kg/}^\circ\text{C kg}$ for $\lambda = 3.3$ (4/10 load),
 δ = volume change before and after the combustion
 $\quad = 1.039$ for $\lambda = 1.8$, 1.021 for $\lambda = 3.3$
 k = Specific heat ratio
 $\quad = 1.304 \sim 1.331$ at $t = 1500 \sim 1000^\circ\text{C}$ for $\lambda = 1.8$
 $\quad \quad k = 1.32$ (assumed for all cases of full load)
 $\quad = 1.314 \sim 1.342$ at $t = 1500 \sim 1000^\circ\text{C}$ for $\lambda = 3.3$
 $\quad \quad k = 1.33$ (assumed for all cases of 4/10 load)

Then,

$$\frac{dG}{d\alpha} = C \cdot \frac{p_z}{\sqrt{T_z}} f \left(\frac{p_v}{p_z} \right)$$

$$C = 0.7756 \quad \text{for } \lambda = 1.8 \text{ (full load)}$$

$$= 0.7741 \quad \text{for } \lambda = 3.3 \text{ (4/10 load)}$$

This computation can be performed easily, if the relation between $\left(\frac{p_v}{p_z}\right)$ and $f\left(\frac{p_v}{p_z}\right)$ is previously prepared.

$\Delta G_{z_1-z_2}$, the quantity flowing at the interval between two adjacent points on the indicator diagram, was determined by the arithmetic mean of the instantaneous flow at these two points. The numerical computations were under-taken at intervals of $1^\circ \sim 2^\circ$ for the main combustion period and of $2^\circ \sim 5^\circ$ for the after-burning period.

Experimental Results and Discussion

I. Influence of Cetane Value of Fuel on Diesel Engine Performance.

1. Preface.

During World War II, synthetic fuel of high cetane value was manufactured by the Hokkaido Artificial Gasoline Company. Since a remarkable increase in fuel consumption and a noticeable decrease in the maximum smokeless-power unexpectedly resulted from the use of this synthetic fuel in a Diesel engine of direct injection type, a series of experiments were undertaken for the purpose of determining their causes.

The problem of cetane value in a Diesel engine began to be discussed after that of the octane value in a gasoline engine. The increase of octane value of fuel was inevitable in a gasoline engine, and an improvement of performance in a Diesel engine was also expected by the increase of cetane value. Even though a fuel of high cetane value was realized later and many experimental results were reported, definite conclusion about the influence upon engine performance has not been reached.

According to the experimental results in the present paper, it may be said that these various discussions originated from the differences among the types of test engine and the operating conditions—viz., type

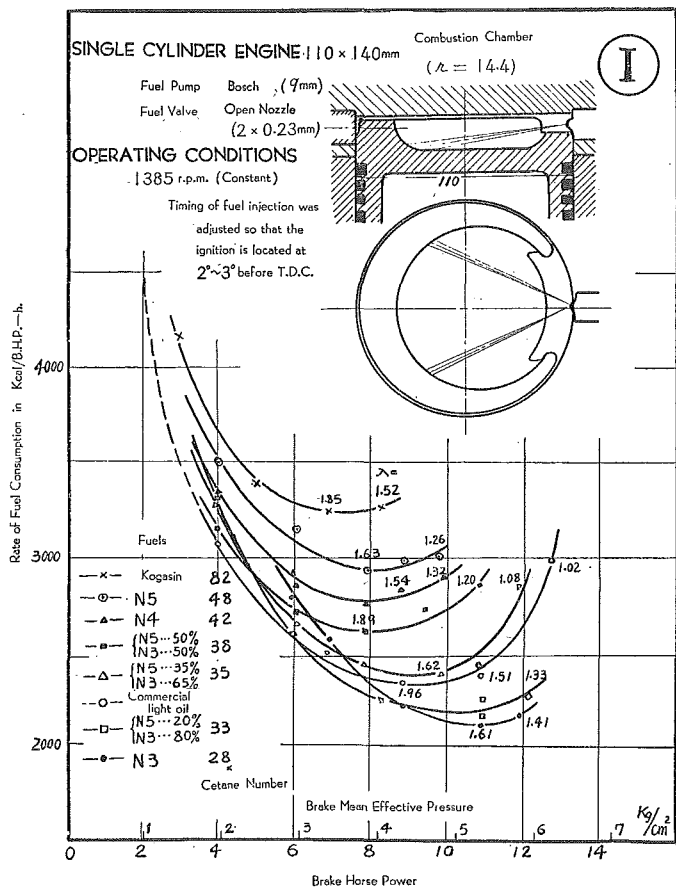

Fig. 5. Rate of Fuel Consumption-Brake Horse Power Curves for Experiment (I).

of combustion chamber, fuel injection system, timing of fuel injection, compression ratio, r. p. m., and load etc.

2. Performance tests on several types of combustion chamber.

(i) Description of experiments.

The types of combustion chamber employed in the present experiments and the experimental results are shown in Figs. 5~9—Experiment (I), (II), (III), (IV) and (V). The engine revolutions were kept at 1400 r.p.m., and the timing of fuel injection was adjusted so that the ignition point was always located at $2^{\circ}\sim 3^{\circ}$ before the T.D.C.

The case of a combustion chamber of horizontal injection is shown in Fig. 5—Experiment (I), and an open nozzle was employed for the fuel valve. As will be seen in this figure, it is a remarkable fact

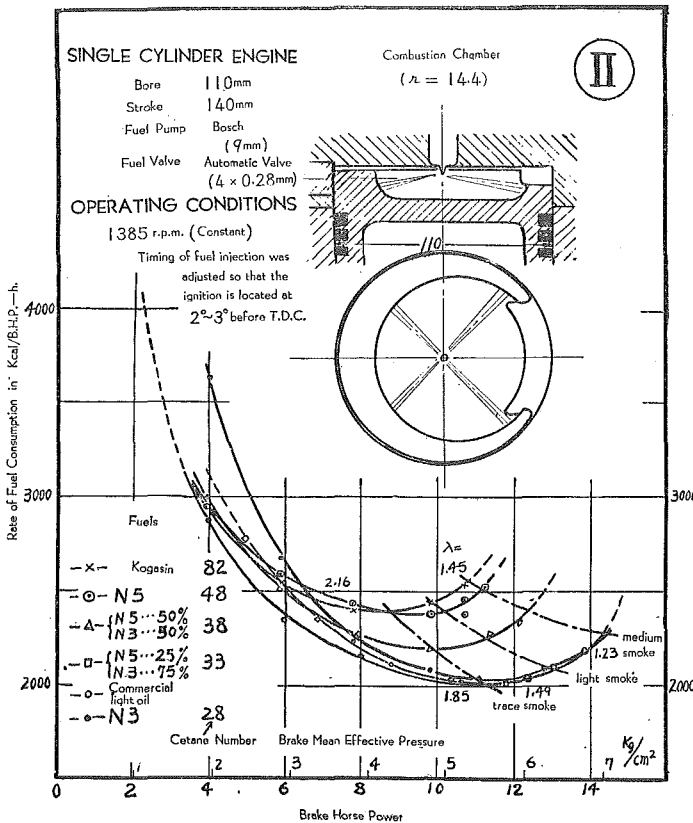

Fig. 6. Rate of Fuel Consumption-Brake Horse Power Curves for Experiment (II).

that the rate of fuel consumption increased very much and the maximum smokeless-power decreased extremely, when a fuel of high cetane value was used. This fact must be caused by the after-burning. In other words, the thermal efficiency becomes poor because of a violent after-burning and a larger amount of fuel is required for the same output so that smoke appears earlier. Since one of the reasons for such a large difference in engine performance was understood to be in the use of an open nozzle and a long period of fuel injection, and since the pulverization of fuel was not favorable, the open nozzle was replaced by an automatic valve. The results obtained are shown in Fig. 6—Experiment (II). The difference of performance due to the variation of cetane value is not so large as was found in the previous experiment. However, this figure also shows that the fuel of high

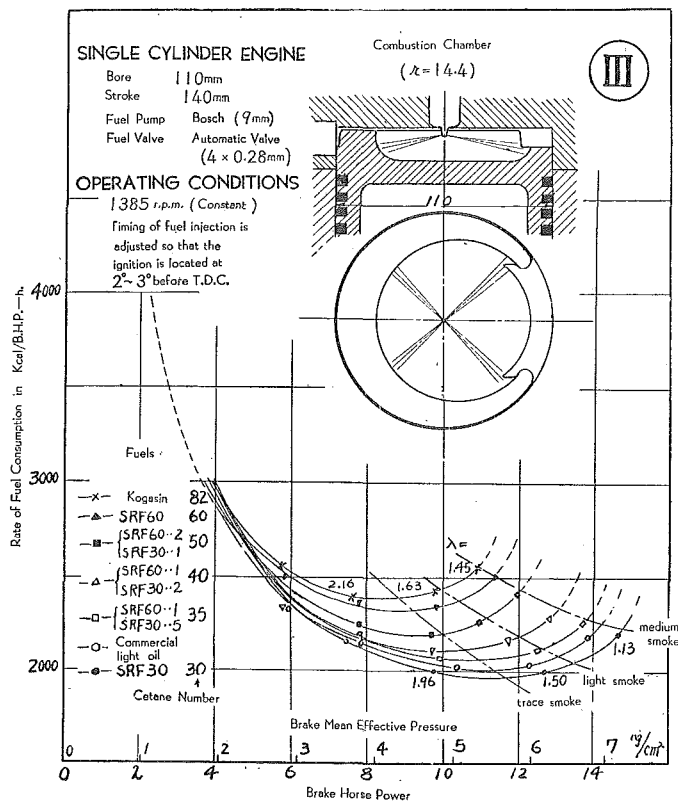

Fig. 7. Rate of Fuel Consumption-Brake Horse Power Curves for Experiment (III).

cetane value causes an increase of fuel consumption and a decrease of output. Besides, the fact, as one can see in this figure, that the fuel consumption increases in the range of light load, when a fuel of N3 or one containing a considerable amount of N3 is used, was caused by a large amount of tar oil content in the fuel. The combustion of tar oil is understood to be poor when the temperature of combustion becomes lower than a certain value. This kind of problem is entirely independent of cetane value. Accordingly, a similar experiment was repeated by using secondary reference fuels for the measurement of cetane value, under the same conditions as in the case of Experiment (II). Their result are shown in Fig. 7—Experiment (III). The tendency in these results is quite similar to the one shown in Figs. 5 and 6.

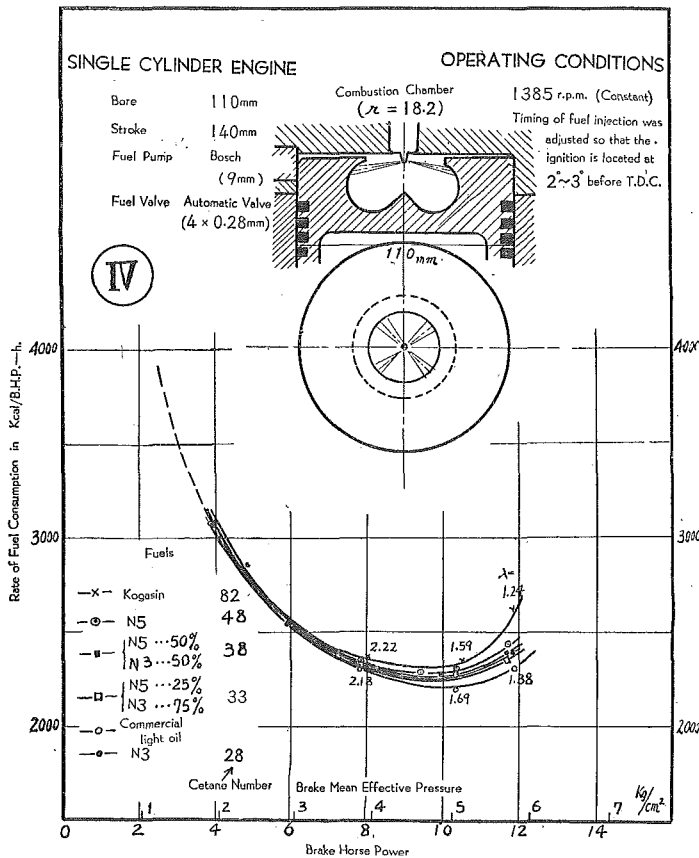

Fig. 8. Rate of Fuel Consumption-Brake Horse Power Curves for Experiment (IV).

Furthermore, the particular aspect of poor combustion was not noticed for fuels of low cetane value even in the range of light load, and the fuel consumption curves are regular. As will be seen in the figure, the influence of cetane value can not be noticed up to the load of about 1/2. When the load is larger than this value, the after-burning tends to be considerable as the cetane value becomes higher, and therefore the fuel consumption increases. As a result, smoke appears earlier in exhaust and the maximum smokeless-power lowers. The values of the excess air factor λ are also indicated in this figure. Judging from this figure, one may see that smoke started at around $\lambda=1.5\sim 1.6$ in this case.

Fig. 8—Experiment (IV) shows the case of a Saurer combustion chamber, the compression ratio of which is 18.2. In this case, the same

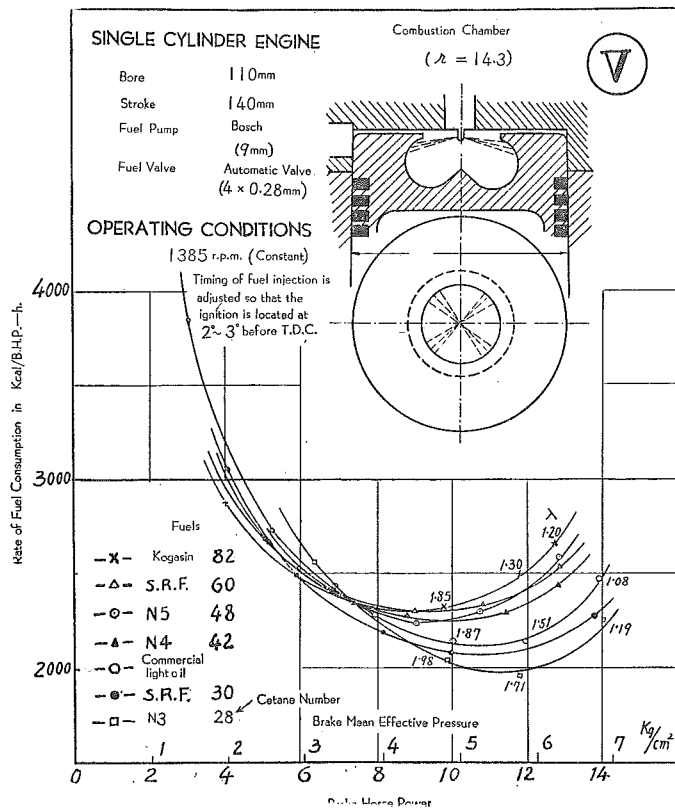

Fig. 9. Rate of Fuel Consumption-Brake Horse Power Curves for Experiment (V).

kind of influence of cetane value noted in the previous cases was hardly seen and it can be said that there is no effect of cetane value on fuel consumption curves. However, when the compression ratio was decreased to 14.3, as is shown in Fig. 9—Experiment (V), the influence of cetane value became noticeable once again.

(ii) Discussion of the experimental results.

By the experimental results described above, the increase of cetane value lowers the performance of an engine when the ignition point is adjusted to be at 2° – 3° before the T.D.C. which point is usually accepted to be proper. For the purpose of clarifying this matter, data on the periods of fuel injection employed for the loads at around the minimum fuel consumption rates are all collated in Fig. 10. The periods of fuel injection for automatic valves and the one open nozzle were measured on the basis of the movement of the valve spindles and on the oscillogram of pressure taken near the nozzle, respectively.

First of all, when the open nozzle is employed, as is indicated by (I) (Fig. 5), the ignition lag is extremely large perhaps because the pulverization was not good, and further, variation of the ignition lag caused by the difference of cetane value is also quite large. An automatic valve was employed in Experiments (II), (III), (IV) and (V). In (II), (III) and (V) the compression ratio was $r=14.4$ or approximately so and the ignition lags become almost the same. Experiment (IV) is the case when the compression ratio was increased to 18.2 in a Saurer combustion chamber. The ignition lag became smaller in this case, and its variation caused by the change of cetane value became extremely small.

From the comparison of the influence of cetane value on the fuel consumption rate explained above and the change of period of fuel injection, the following relations can be derived. The reason for high rate of fuel consumption for higher cetane value is in the shortening of the ignition lag. It results that the cut-off point of fuel injection

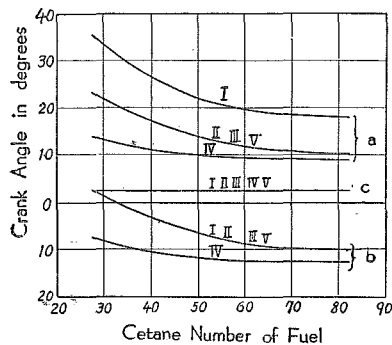

Fig. 10. Timing of Fuel Injection for Each Experiment at the Point of Minimum Fuel Consumption Rate.

- a. Beginning Point of Fuel Injection.
- b. End Point of Fuel Injection.
- c. Ignition Point.

becomes late because of the late beginning of injection, and the most part of the fuel is injected after the ignition point. First of all, in the case when the compression ratio is the same as is shown in (I), (II), (III) and (V) (Figs. 5~7 and 9), the fuel injection is completed before the T.D.C. when the cetane number of fuel is 30~35 and the most part of fuel is injected after the T.D.C. in the case of Kogasin fuel. This kind of late cut-off of fuel naturally becomes one of the reasons of lowering the efficiency. The rather large difference of fuel consumption rate in this experiment seems not to be attributed only to these reasons. One can naturally conclude that there is a considerably large difference in the after-burning after the cut-off of fuel itself. In the case of a fuel of low cetane value, the vaporization, the dispersion and mixing of fuel into air before the ignition must be considerably well completed, since the ignition lag is large and the most part of fuel is injected before the ignition, and the other part of fuel would also burn completely rather quickly. In the case of a fuel of high cetane value, however, one can understand that the after-burning becomes severe, since the most part of the fuel is injected after ignition and its combustion would be disturbed by the combustion gas burned previously. The temperature of combustion gas is high and that temperature promotes the combustion, but the most important thing for the combustion of a Diesel engine is a good contact of fuel with air.

In Experiment (IV) a Saurer combustion chamber of 18.2 in compression ratio was used. In this case, the difference of ignition lag due to the difference of cetane value decreases extremely, and the fuel which will be injected after ignition can make a good contact with air, since the combustion chamber is a type which promotes high turbulence. As the result, the after-burning could be understood to be almost the same for all fuels; any considerable difference in fuel consumption rate was not detected. The difference in fuel consumption rate was so slight that it could be attributed to the difference of the cut-off of fuel injection.

In order to clarify more precisely the reasons discussed above, the comparison between SRF 30 and Kogasin 82 shown in Experiment (III) (Fig. 7) will be explained as an example. The variations of the maximum pressure p_3 , excess air factor λ' , theoretical thermal efficiency η_{th} , and indicated thermal efficiency η_i graphed against the output are shown in Fig. 11. p_3 and λ' are experimental values, and η_{th} was calculated with p_3 and λ' as a Sabathe cycle with the initial conditions

of $p_1 = 0.95$ at. and $T_1 = 350$ K. The curve of η_i is the value computed from the fuel consumption with the friction power of 5 HP actually measured.

First of all, the curve of η_{th} for Kogasin 82 is lower than that of SRF 30, since p_3 and λ' are both smaller. However, the reason of lowering λ' in this case is that the thermal efficiency was decreased due to the increase of after-burning. And so, when η_{th} is computed with the same value of λ' as possessed by SRF 30 for the purpose of obtaining only the effect of the maximum pressure, the results become as shown by the chain line. The difference between this chain line and the curve of η_{th} for SRF30 can be understood to represent the magnitude of decreasing in thermal efficiency due to the difference of the maximum pressure. When the difference between these two curves is compared with the difference in η_i , one can see that about 1/3 of the difference in fuel consumption rate originates in the difference of the maximum pressure due to the variation of cetane value, and that the other 2/3 comes from the degree of after-burning.

Next, in order to ascertain the degree of after-burning, the progress

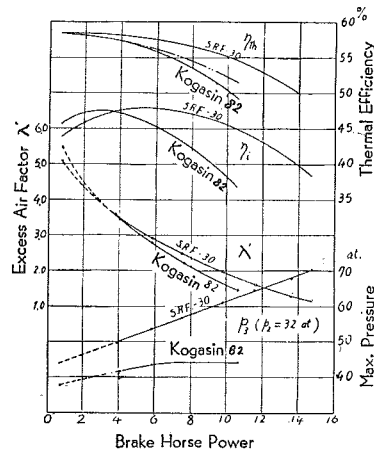

Fig. 11. Comparison between the Fuels of S.R.F. 30 and Kogasin 82.

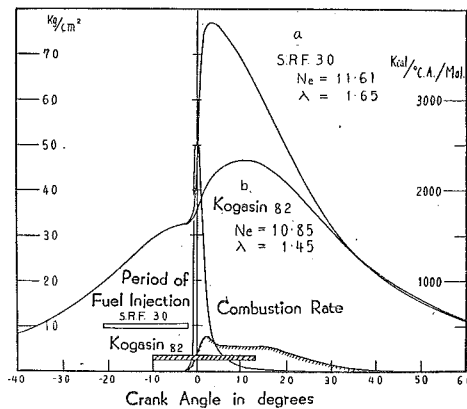

Fig. 12. Comparison of Indicator Diagram and that of Combustion Rate for the Fuels of S.R.F. 30 and Kogasin 82.

of combustion was calculated on the basis of indicator diagrams. Fig. 12 shows also the cases of SRF 30 and Kogasin 82 in Experiment (III). One can clearly see the reason for decrease in thermal efficiency when a fuel of high cetane value was used. In the case of SRF 30, the most part of fuel burns at the time of initial rapid combustion and the other part also finishes burning quickly. On the other hand, when Kogasin 82 is used, the initial combustion is quite slow and the period of after-burning elongates. Consequently, also the whole period of combustion for Kogasin 82 becomes longer.

3. Cases when the timing of ignition is changed.

As the timing of fuel injection for a Diesel engine is commonly regulated so that the ignition starts at about 2° – 3° before the T.D.C., the experiments described in the preceding chapter were performed with the ignition point fixed there. However, this point of timing is too late for a fuel of high cetane value as will be seen on the indicator diagram and the line of combustion rate shown in Fig. 12. Therefore, it was undertaken to find the timing of fuel injection for the minimum fuel consumption rate by changing the ignition point. Of course, if the timing of fuel injection is advanced, both the maximum pressure and the rate of pressure rise are increased even for a fuel of high cetane value, and the anti-knock property must be sacrificed to some extent. So, it is practically rather difficult to determine a proper timing of fuel injection.

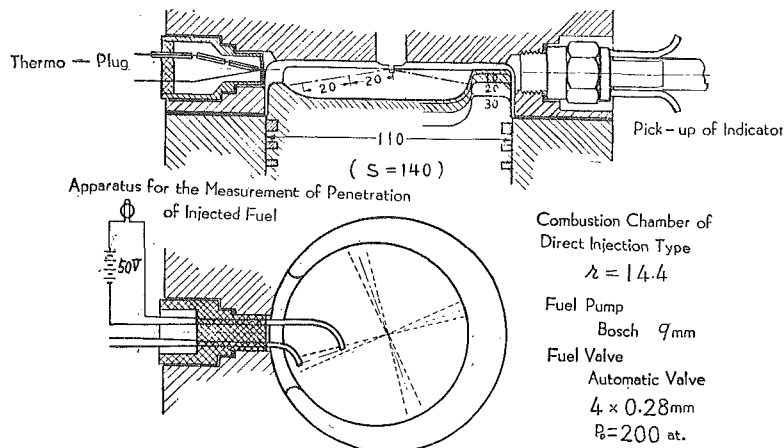

Fig. 13. Details of Combustion Chamber, Thermo-Plug and Device of Measuring Penetration of Fuel.

The experimental engine and the experimental methods were same as those employed in the preceding chapter; the experiment was undertaken only for the combustion chamber used in Experiment (III) described in the previous chapter. Details of the combustion chamber are shown in Fig. 13. The temperature was measured by the thermo-plug inserted through the horizontal hole made for the open nozzle, since a vertical automatic injection valve was employed. The records made by this thermo-plug may represent the temperature of the cylinder wall.

(i) The case of heavy load.

The performance of the engine when the timing of fuel injection is changed for a constant load of 10 HP at 1400 r.p.m. is shown in Fig. 14. The right- and left-side of this figure are the performances against the timing of ignition and the beginning of injection, respectively.

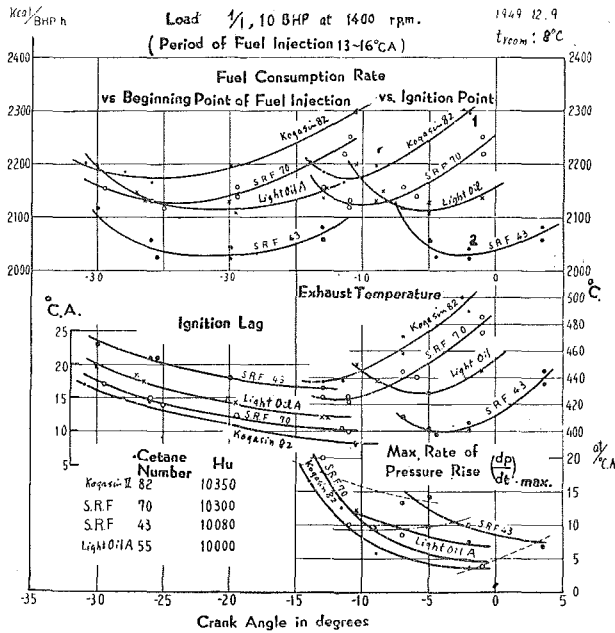

Fig. 14. Performance Curves. Full load of 10 BHP at 1400 r. p. m. (Period of Fuel Injection : 13°~16° C. A.)

First of all, one may see that the minimum fuel consumption rate is found for considerably earlier timing of ignition with an increase of cetane value. At the same time, the earlier timing of fuel injection

is desirable. Even though the difference in fuel consumption is quite large when the timing of ignition is at $2^{\circ}\sim 3^{\circ}$ before the T.D.C. as in the cases previously described, that difference decreases with the advancement of ignition point. Even at the points of minimum fuel consumption rate, the tendency of showing a higher fuel consumption still remains with an increase of cetane number.

In order to find a clue for the explanation of these facts, it was undertaken to find the combustion progress from indicator diagrams. Some of the examples are shown in Figs. 15, 16, 17 and 18. It must be noted here that the part of cooling loss is not taken into consideration. The constant-volume degree of combustion was also obtained

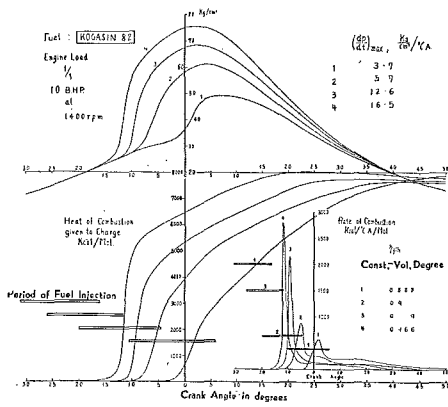

Fig. 15.

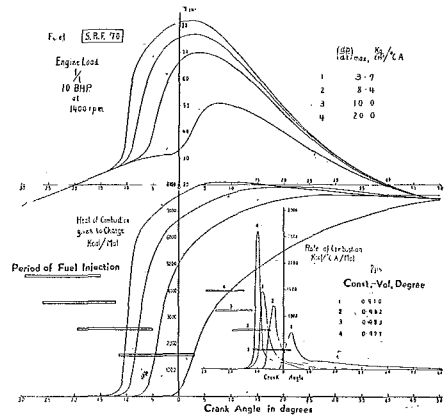

Fig. 16.

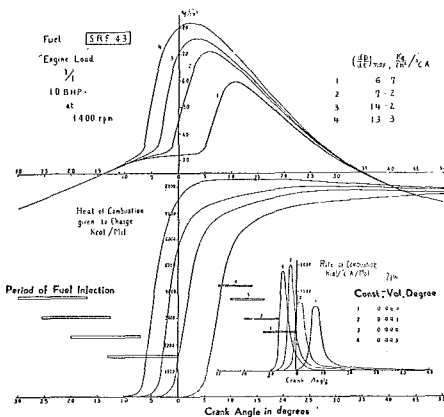

Fig. 17.

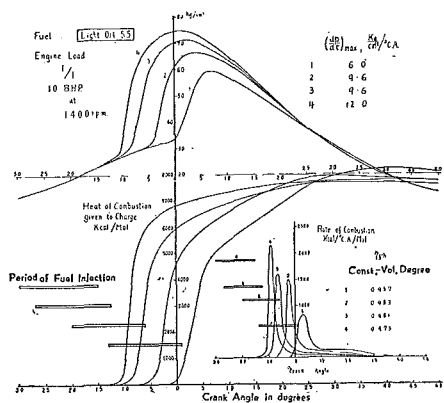

Fig. 18.

Figs. 15-18. Indicator Diagram and Combustion Progress.

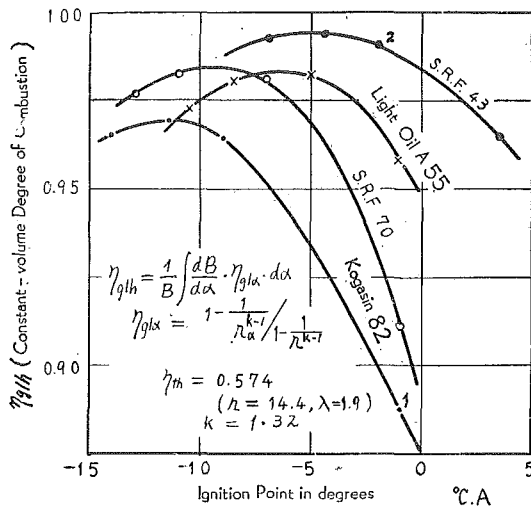

Fig. 19. Constant Volume Degree of Combustion Computed from Combustion Progress.

with the equation shown in Fig. 19, taking the combustion at the T.D.C. as unity. The tendency of the curves of η_{gth} and fuel consumption rate shown in Figs. 19, 14 respectively agreed unexpectedly well. Furthermore, the comparison between Kogasin 82 of $\eta_{gth}=0.888$ and SRF 42 of $\eta_{gth}=0.991$ at the points 1 and 2, respectively, in Fig. 19, for example, must give the difference of $2030 \times \frac{0.991 - 0.888}{0.888} = 232$ Kcal/BHP-h in the fuel consumption rate. This value coincides fairly well with the one obtainable from the fuel consumption curves in Fig. 14. Accordingly, it can be understood that the change of fuel consumption rate with cetane value exists in the difference of the progress of combustion. Of course, the imperfectness of combustion, cooling loss, and friction loss are also factors that have some influence upon the fuel consumption rate, but they would almost be independent of cetane value.

The advancement of the ignition point to the point of maximum thermal efficiency means a device to make the combustion occur in the neighborhood of T.D.C. as nearly as possible. In other words, the combustion process (after η_{gth} is taken into consideration) should be made to occur equally on the two sides of the T.D.C. Of course, since a larger cooling loss accompanies at the earlier combustion, the timing of the actual combustion process should deviate more or less toward the side after the T.D.C. Consequently, if the timing of

ignition for the maximum thermal efficiency is located at an earlier point, the combustion should also finish later, with the result that the constant-volume degree of combustion and the thermal efficiency must decrease. Further, it can be said that the thermal efficiency becomes lower when a fuel of high cetane value is used, because the part of fuel which burns at the instant of ignition is small and the total period of combustion elongates, for the lag of ignition is small even at the point of minimum fuel consumption. In the case of this kind of combustion chamber, which is characterized by a considerable change of ignition lag with cetane value, there is a very large difference in the progress of combustion, which results in a large influence upon the fuel consumption rate, so far as the same fuel injection apparatus is employed. It can also be seen that the temperature of exhaust gas becomes higher with the increase of the fuel consumption rate.

For the purpose of further examination of the progress of combustion, Fig. 20 is prepared from data graphed in Figs. 15~18. One can attain the following conclusions with the aid of this figure:

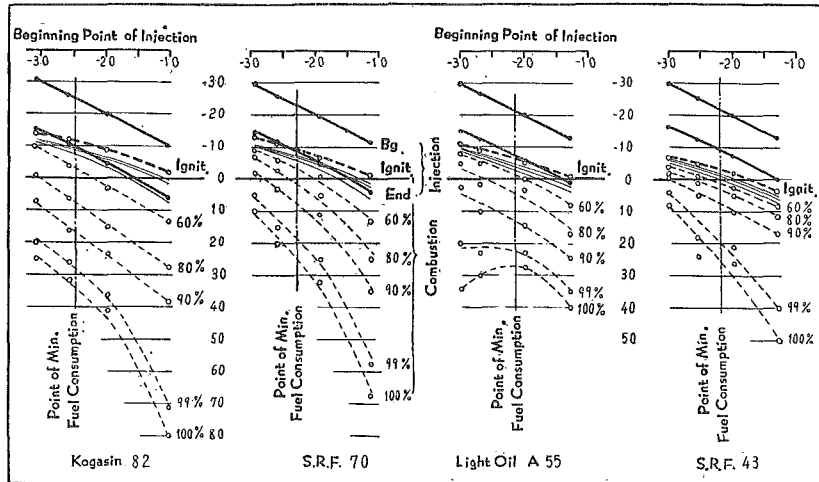

Fig. 20. Combustion Progress transferred from Figs. 15-18 (Full Load).

(a) Curves of 60~80% combustion lines show that the duration of time required for each combustion is approximately inversely proportional to the period of ignition lag. It can also be seen that the period of combustion becomes long when the fuel injection continues until after the beginning of ignition. The reasons are in the different

preparation for combustion resulting from the magnitude of ignition lag and in the degree of disturbance of mixing and contact with air of the fuel injected after the ignition. These are the main reasons that caused the difference in constant-volume degree of combustion explained above. If the attainment of minimum fuel consumption rate is intended to be realized, the timing of fuel injection must be adjusted so that about 60~70% of fuel would burn before the T.D.C.

(b) The duration of combustion from 80% to 90% does not differ much as before with the timing of injection and the cetane value of fuel. It may be understood that the influence of the ignition lag gradually diminishes at this period.

(c) The duration of combustion for the last 10% of fuel which remained becomes exceedingly long, if the period of its combustion is located far after the T.D.C. This fact may be understood to mean that the contact and the reaction between fuel and air become poor with the decrease of pressure and temperature by expansion. In the case of light oil A, however, the after-burning becomes large for early timing of injection. The result seems to be inherent only to this fuel; the other light oils of the same cetane value did not show such a nature.

The rate of maximum pressure rise $\left(\frac{dp}{dt}\right)_{\max}$ measured on indicator diagrams is shown in Fig. 14 against the timing of ignition. The value $\left(\frac{dp}{dt}\right)_{\max}$ for fuels becomes large with the advancement of the timing of fuel injection, since the ignition lag increases. When $\left(\frac{dp}{dt}\right)_{\max}$ is compared at the same timing of ignition, it becomes smaller with the increase of cetane value, since the ignition lag becomes smaller. These facts can be naturally expected, but it may be worth-while to examine the values of $\left(\frac{dp}{dt}\right)_{\max}$ for the minimum fuel consumption rate shown with a chain line in Fig. 14. The values of $\left(\frac{dp}{dt}\right)_{\max}$ are almost the same for all cetane values of fuels. Accordingly, if the timing of fuel injection is selected at the point of minimum fuel consumption rate, the advantage of the antiknock property of high cetane fuel must be sacrificed. Even at the point of minimum fuel consumption rate, the amount of fuel injected before ignition point must be smaller for the fuel of comparatively higher cetane value, since the ignition lag is

smaller. However, the fact that values of $\left(\frac{dp}{dt}\right)_{\max}$ are almost the same for all cetane values may merely signify that the inherent combustibility of the fuel is higher for higher cetane value. The values of $\left(\frac{dp}{dt}\right)_{\max}$ for a constant beginning point of fuel injection are given by two broken lines in Fig. 14. When the timing of fuel injection is late, the influence of ignition lag becomes large and $\left(\frac{dp}{dt}\right)_{\max}$ becomes smaller for higher cetane value, since the amount of fuel injected before the ignition is small. On the other hand, when a considerable early timing of fuel injection is employed, the injection finishes before ignition for all fuels and $\left(\frac{dp}{dt}\right)_{\max}$ increases with the higher cetane value. Accordingly, these facts also indicate that the fuel of higher cetane value has a higher inherent combustibility.

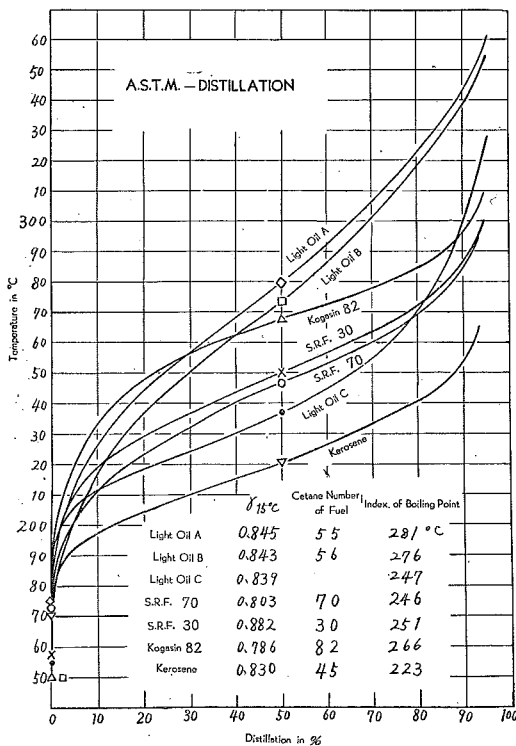

Fig. 21. A.S.T.M. Distillation Curves of Fuels.

It is generally said from the experimental result of one drop of fuel that its combustion velocity is proportional to the "evaporation ability" and is independent of the cetane value. In the case of actual combustion in a Diesel engine, however, most of the fuel droplets are crowded and the combustion of each droplet usually occurs under the condition of air shortage. In such case, the chemical structure of the fuel itself may also be understood to have some relation with the combustion speed. In this meaning, the inherent combustibility of a fuel one is concerned signifies the combustibility under a condition of actual combustion in a Diesel engine. Fig. 21

shows the A.S.T.M.-distillation curves of the fuels used in the present investigation.

(ii) The case of light load.

The performance curves shown in Fig. 7 show that the fuel consumption rates almost coincide at about 4 BHP. This result comes from the fact that the influence of the timing of fuel injection decreases, since the fuel injection finishes before the ignition at that load. As

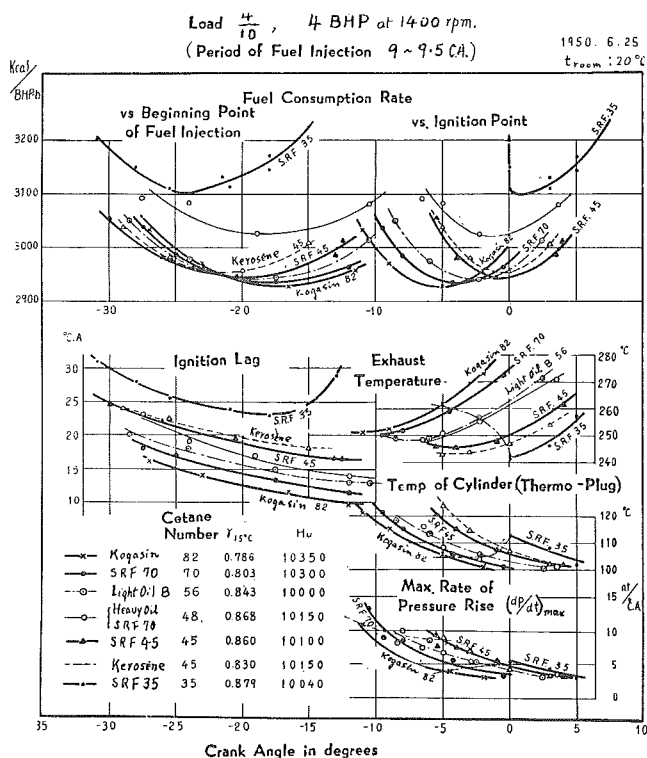

Fig. 22. Performance Curves. 4/10 Load of 4 BHP at 1400 r.p.m. (Period of Injection: 9°~9.5° C. A.)

it was judged that the difference of the inherent combustibility would evidently appear in the range of such a load where the influence of the injection timing is small, careful experiments were performed at a constant load of 4 BHP for various kinds of fuel. Since the results of several experiments gave the same tendency, only one example is shown in Fig. 22.

First of all, the comparison of the fuel consumption rate between

4 BHP and full load reveals several differences. At first the timing of ignition for the minimum consumption rate tends to be closer together than in the case of full power, and the beginning point of injection for the minimum consumption rate is retarded with the higher cetane value. Secondly, the minimum fuel consumption rate is lowered with the higher cetane value, even though the magnitude is small. The first difference resulted because the difference in the combustion progress was not so large as before, for the fuel injection finishes before the ignition at this load. The reason for the second difference can not be explained from the combustion progress. One can merely understand from the combustion progress that the duration of combustion should elongate with the higher cetane value and that the thermal efficiency should decrease. Especially, the temperature of exhaust gas for SRF 35 is low in spite of an extremely large fuel consumption rate. What is the reason for this contradiction between the fuel consumption rate and the exhaust gas temperature? Since incomplete combustion was judged to be the only reason for this contradiction, the analysis of exhaust gas and the measurement of penetration of the injected fuel were performed.

Analysis of exhaust gas.

The analysis of exhaust gas was undertaken by changing the timing of fuel injection under the condition of 4 BHP and a constant speed of 1400 r.p.m. The analysis was made with an improved Orsat apparatus. Since the content of CO in the exhaust gas very slight and H_2 , CH_4 , C_mH_n were scarcely detected in several samples, this method was judged to be satisfactory. In the combustion in an Diesel engine it was assumed that a part of C changes into CO_2 and CO, and that the other part of C becomes a soot; the quantity of soot was computed by means of the volume of suction air and the results of exhaust gas analysis. The results of this computation are shown in Fig. 23.

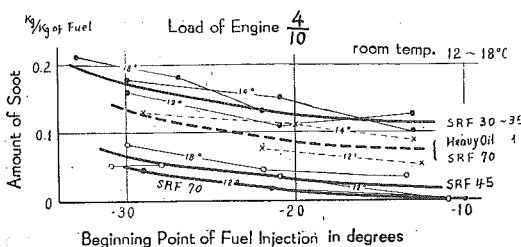

Fig. 23. Calculated Value of Soot in Exhaust.

Fuels	C	h	S
SRF 70	85.8	14.2	(S=0.05)
SRF 30	87.5	12.5	(S=0.06)
Heavy oil	87.0	12.5	

The colour of exhaust gas was almost so-called smokeless, and the reliability of the absolute value of this soot is small. However, it would not be unreasonable to understand that this value of soot would fairly represent the degree of incompleteness of combustion. It can be seen in Fig. 23 that the quantity of soot increases for the lower cetane value. The quantity of soot is extremely large for SRF 30~35, because these fuels are of so low cetane value that the ignition point could not be advanced by the advancement of fuel injection for the compression ratio of this engine. In these cases, the combustion may be imperfect. The quantity of soot is also large in the case of the blended fuel of Mili heavy oil and SRF 70 in spite of its considerably high cetane value. Actually, the amount of accumulated carbon on the surface of the combustion chamber was large. Judging as a whole, one may be able to understand that the reasons for contradiction between the fuel consumption rate and exhaust gas temperature and of fuel consumption rate at the point of the minimum fuel consumption rate for high cetane value exist in the difference of this incompleteness of combustion, since the fuel consumption rate and the amount of soot are approximately proportional.

Measurement of penetration of injected fuel.

The influence of the timing of fuel injection given in Fig. 23 shows that the amount of soot increases by the earlier timing injection. This result was understood to have been caused by the worse conditions of temperature and pulverization of fuel as well as by the combustion of a part of fuel after having adhered once to the piston surface, since the amount of soot increases with the advancement of fuel injection. Accordingly, the penetration of injected fuel was measured as the next step of investigation.

The measurement was performed by using water in place of fuel. Two electrodes with a gap about 0.1 mm were placed in the path of the injected fuel as is shown in Fig. 13 and the arrival of pulverized water was recorded. The results of measurement are shown in Fig. 24. When the injection is early, the penetrating speed of the injected fuel is fast, because the density of air in the cylinder is small. As the result, the pulverized fuel would reach the piston surface rather earlier, and it is possible that a considerable amount of fuel burns after once adhering to the surface. This kind of combustion mechanism may probably be one of the reasons for the incomplete combustion

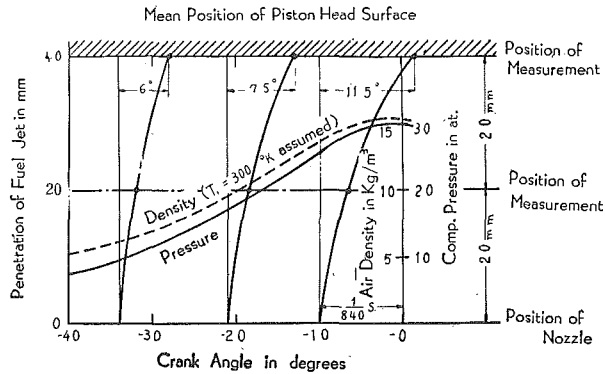

Fig. 24. Penetration of Fuels Jet Tested with Water.

Pump : Bosch 9 mm, r.p.m. of Engine 1400.

Nozzle: 4×0.28 mm, Injection Period 17°C.A.

p_0 : 200 at.

which occurred when the timing was early. It may also be possible that there are some differences in the incompleteness of combustion due to the structure of hydrocarbon, when this kind of combustion on the surface occurs.

The maximum rate of pressure rise for the minimum fuel consumption rate becomes as shown by the fine line in Fig. 22. It becomes a little lower for the fuel of high cetane value. Under the condition of less influence of the timing of fuel injection by advancing its timing so that the ignition lag would be rather large, the rate of maximum pressure rise becomes larger for the fuel of higher cetane value as is shown by the broken line in the same figure.

The measurement of temperature was also performed in this case with a thermo-plug as shown in Fig. 13. The results of measurement are also graphed in Fig. 22, which shows that the temperature is approximately proportional to the rate of pressure rise by combustion.

4. Conclusions.

In the case of a combustion chamber of direct injection type, the difference of the ignition-lag angle due to the difference of fuel cetane value is large, and cetane value of fuel exerts a large influence upon the performance of an engine. If the cetane value of a fuel is high, the amount that burns at first is not so large, because the amount of fuel injected before the ignition is small and the duration of preparation for combustion is also short. Consequently, the most part of

the fuel will burn gradually after the first rapid combustion. In this case, even if the fuel would be exposed to the high temperature of combustion gas, the combustion will be disturbed by the gas already burnt, and the elongation of the combustion period must accompany. As a result, the thermal efficiency itself must also be lowered. Even if the comparison of the points of minimum fuel consumption rate is the intended purpose of the experiment, it is found that the ignition lag is small for higher cetane value, and the effect of cetane value is still left.

It can be said in general that the combustibility of a fuel in a combustion chamber is good and incomplete combustion occurs in small degree when the cetane value is high.

In the case of a light load, the fuel injection will be finished before the ignition, because the period of fuel injection becomes shorter and the ignition lag becomes larger. This means that the effect of the timing of injection becomes less, and the lowering of thermal efficiency decreases. On the other hand, it sometimes happens that the thermal efficiency improves when a fuel of high cetane value is used for a load less than a certain value, because the difference in combustibility and incomplete combustion can not be avoided.

Concerning the relation between cetane value and knocking, the phenomenon of knocking in a Diesel engine is different from that caused by the abnormal rapid combustion in a gasoline engine. The knocking in a Diesel engine indicates a difference of combustion velocity that will be governed by the amount of fuel at the point of ignition, and can be changed for any operating condition. However, if a device for decreasing knocking is employed, the thermal efficiency will generally be lowered, and a device of preventing the lowering of thermal efficiency must be expected to result in a severe knocking. Some devices for decreasing the initial combustion velocity and finishing the combustion as quick as possible is preferable, but it would practically not be easy. For instance, the employment of a pilot injection or a fuel nozzle of throttle type is simple and effective for the purpose of restricting the knocking when a fuel of low cetane value is used, but it is still doubtful if the combustion is quickly and perfectly completed.

Although the above discussions are based upon the results of measurements on an engine with a combustion chamber of direct injection type for a certain constant speed, the effect of cetane value upon a higher speed must be larger and it must be smaller for a lower

speed, as far as the effects of cetane value exist in the difference of ignition lag and combustion progress. Concerning the effect of compression ratio, the difference in ignition lag will be decreased by increasing the compression ratio and the effect of cetane value must be reduced. Moreover, the combustion chamber and the fuel injection system with less difference in ignition lag depending upon the kind of fuel must be less effected by cetane value. With regard to the turbulence of air, the larger turbulence will give the better contact between air and fuel, and the effect of cetane value will also be reduced.

II. Combustion Progress when Pilot Injection is Employed.

1. Preface.

Pilot injection is a device for reducing the knocking in a Diesel engine of direct injection type and is practically applied mainly in England. Since the use of pilot injection results in the decrease of the ignition lag of the fuel of the main injection, a reduction of knocking can be naturally expected. However, the rise of a problem whether

the use of a pilot injection would make the latter half of combustion slow resulting in severer after-burning accompanied by a reduction of thermal efficiency must be expected from the results obtained in Study I. Therefore, some experiments were undertaken in order to clarify these points.

2. Experimental method.

The experimental engine is a single cylinder type with 110 mm × 140 mm cylinder dimensions; it is an engine of direct injection type as shown in Fig. 25. Two perfectly independent injection pumps and nozzles are employed. The horizontal and

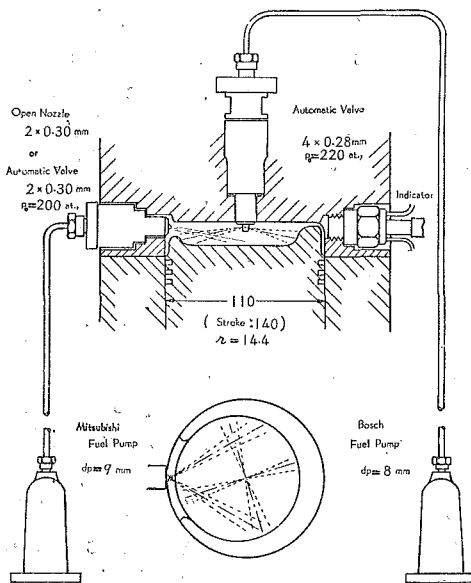

Fig. 25. Arrangement of Fuel Valve for Pilot Injection.

vertical fuel injection valves were mainly used for pilot and main injections, respectively, but the reverse arrangement was also tested. Although an open nozzle originally attached to this engine was first used as the horizontal pilot injection valve, it did not give good results. Therefore, it was replaced by an automatic valve with the same diameters of nozzles except in the first experiment designated by (A).

All the experiments were performed with a commercial light oil of cetane value 55 as the main injecting fuel and with the same light oil or Kogasin II of cetane value 82 as the fuel for pilot injection. Since the pilot injection of a commercial light oil did not give an effective pilot combustion when the load was light or when an open nozzle was used, Kogasin II was used for the purpose of giving an effective pilot combustion, and its effect was investigated.

The amount of fuel and the timing of pilot injection were adjusted to any time so that they would give a proper pilot combustion and a preferable effect on indicator diagram by judging the indicator diagram obtained on a Braun tube. Since the injection became irregular when the amount of injection was quite small, the amount of pilot injection could not be decreased beyond a certain point. However, the purpose of these experiments was not disturbed, for an effective pilot combustion did not occur if the amount of injection was below that limitation.

Concerning the experimental method, the test was continuously performed with and without pilot injection in turn after obtaining a stable running condition under the speed of 1400 r.p.m. and 4 BHP or 7 BHP; the fuel consumption and indicator diagrams were obtained. The indicator diagrams explained by the phrase "pilot injection only" in Figs. 26~34 were taken from the tests with pilot injection at the instant of cutting the main injection.

The cooling loss was taken into account in all the computations of the progress of combustion in this section, because the amount of heat generated by combustion is small when only the pilot injection is employed and judgement of the progress of combustion becomes difficult without taking the cooling loss into account. However, since the measurement of cooling loss under an actual running condition is very difficult, the cooling loss for the state of self-running obtainable just after cutting all the fuel was assumed as the value of cooling loss. The cooling loss assumed in this manner can easily be computed as the difference between the work done given by compression and the

increase of internal energy of the air in cylinder by analysing the indicator diagram taken just at the moment of cutting all the fuel.

3. Experimental results and discussion.

The experiments were undertaken for the following three cases, and three records of each case are shown in Figs. 26~34. The indicator diagrams, the diagrams of combustion progress computed from the indicator diagrams, fuel consumption rate, and the temperature of exhaust gas are also shown in these figures.

- | | | | | |
|-----|-----------------|--|--|-------------------------------------|
| (A) | Pilot injection | Horizontal open nozzle | Kogasin | — 4 B.H.P. ... { Fig. 26
Fig. 27 |
| | | (2×0.25 mm, d_p : 8 mm) | | |
| | Main injection | Vertical automatic valve | ... Light oil | — 7 B.H.P. ... Fig. 28 |
| | | (4×0.28 mm, p_0 : 200 at., d_p : 9 mm) | | |
| (B) | Pilot injection | Horizontal automatic valve | { Kogasin — 4 B.H.P. ... Fig. 29
Light oil — 4 B.H.P. ... Fig. 30 | |
| | | (2×0.25 mm, p_0 : 200 at., d_p : 9 mm) | | |
| | Main injection | Vertical automatic valve | ... Light oil | — 7 B.H.P. ... Fig. 31 |
| (C) | Pilot injection | Horizontal automatic valve | { Kogasin — 4 B.H.P. ... Fig. 32
Light oil — 4 B.H.P. ... Fig. 33 | |
| | Main injection | Vertical automatic valve | | ... Light oil |

The indicator diagram *C* in Fig. 26 was obtained for the same beginning point of main injection as in the case of diagram *A* by applying a pilot injection and by decreasing the amount of the main injection so that the output would always be constant. One can see that the combustion velocity of the main injection fuel is obviously very slow. The curve *C—C'* represents the difference between the total combustion progress *C* and the combustion progress of the fuel injected by pilot injection *C'* and it represents the combustion progress of the main injection fuel. The indicator diagrams for an earlier timing of the main injection than before are shown in Fig. 27. It may also be clearly seen that the combustion velocity with a pilot injection is slow.

Fig. 28 is the case of 7 BHP output. Though an effective pilot combustion could not be obtained unless a quite early pilot injection was applied in the previous case of 4 BHP, a effective pilot combustion was obtained even for a late pilot injection in this case. In the case with a pilot injection indicated as *D*, the combustion velocity of the main injection fuel is a little slower than in the case without pilot injection *A*, but there was almost no difference between the cases

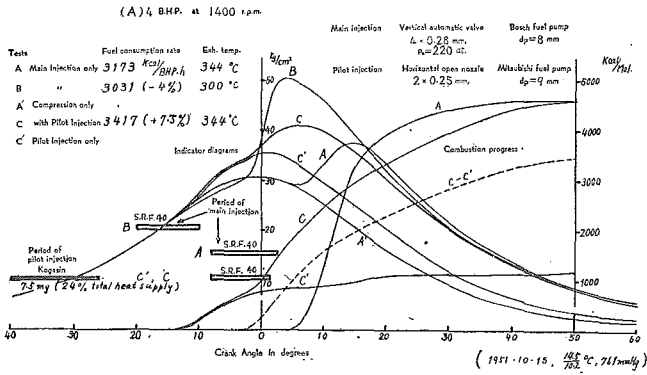

Fig. 26.

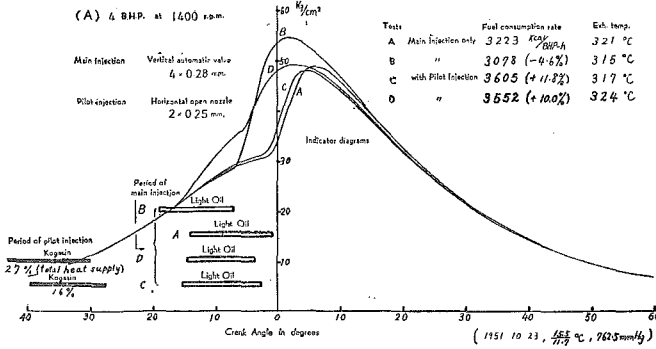

Fig. 27.

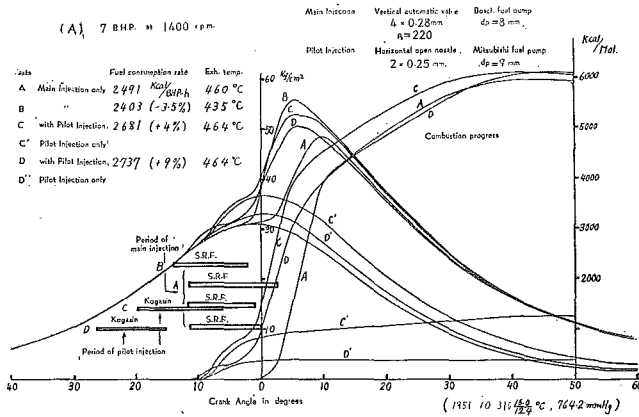

Fig. 28.

Figs. 26-28. Indicator Diagram and Combustion Progress in the case (A).

of *C* and *A*. Since the combustion of the main injection fuel begins after the end of main injection in case *C*, the effect of a pilot injection would scarcely appear.

In Experiment (A), the fuel consumption rate was considerably increased when a pilot injection was employed. The slow combustion of the main injection fuel is of course one of the reasons for the increase in the fuel consumption rate, but its main reason exists in the facts that the pulverization by the horizontal open nozzle which was used for the pilot injection was not good and the combustion of the pilot injection fuel itself was quite bad.

Experiment (B) is the case when the open nozzle was replaced by an automatic valve with the same size of nozzles for the purpose of improving the pulverization of the pilot injection fuel. Fig. 29 *B* shows the result of experiment when the timing of pilot injection was comparatively advanced so that its effect could be obtained as clearly as possible. The comparison between the indicator diagrams *A* & *B* shows that the rate of pressure rise is very small and the after-burning increases in diagram *B*. The increase of fuel consumption rate in diagram *B* is comparatively small as a figure of 1.2%, because the timing of fuel injection in the case *A*, which was taken as the object of comparison, was a little retarded. Fig. 29 *C* is the case when the timing of fuel injection was selected with an intention of obtaining the most favorable indicator diagram. When this diagram is compared to *A*, it can be seen that the pressure rise is slow and the after-burning is not so bad. Three percents of decrease in fuel consumption rate compared to *A* resulted because the constant-volume degree for *A* taken as the base of comparison was not so good.

Fig. 30 shows the case when a commercial light oil, the same as the main injection fuel, was used for the pilot injection. An effective pilot combustion is rather difficult of attainment when a commercial light oil is used. In the cases of *C* and *D* the pilot injection and the main injection were continuously made and the results are similar to the case of single injection with an early timing of injection. In the present case, however, the fuel injection was made by two valves. Therefore, a comparatively unfavourable pulverization of fuel at the beginning and the end of injection was doubly superposed, and a small decrease of fuel consumption rate was obtained in spite of the advanced timing of fuel injection. *B* represents the case of a larger amount and an advanced timing of pilot injection. Since a pilot combustion

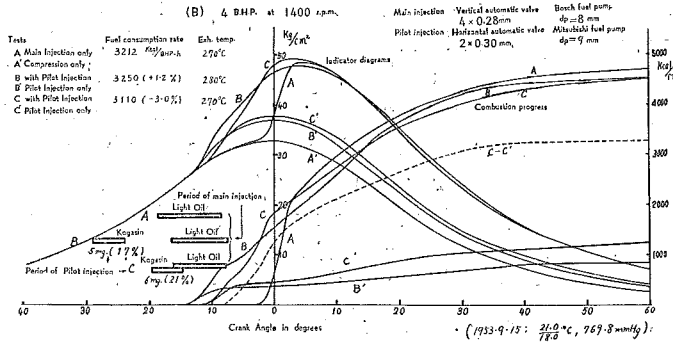

Fig. 29.

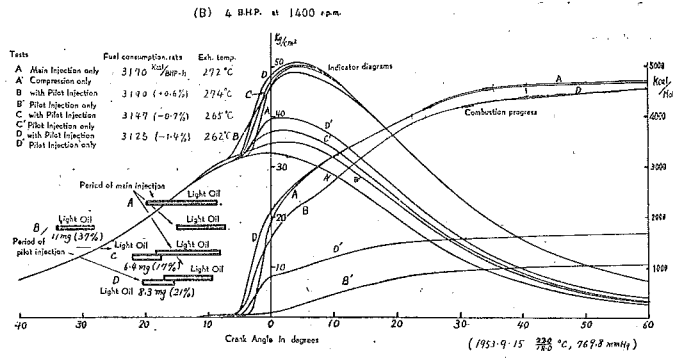

Fig. 30.

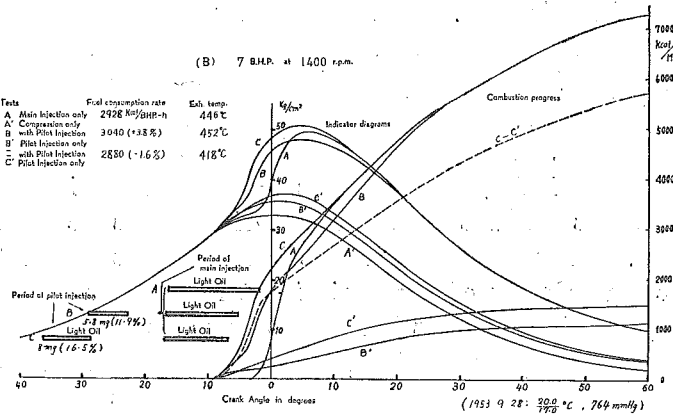

Fig. 31.

Figs 29-31. Indicator Diagram and Combustion Progress in the case (B).

occurs in this case, an early ignition of main injection fuel, a small rate of pressure rise and an effect of the pilot injection result and the after-burning becomes severer.

In the case of 7 BHP as shown in Fig. 31, a clearer pilot combustion can be obtained. Curve *B* is the case of the smallest amount of pilot injection, and the results show that a clear pilot combustion is caused to occur to a considerable extent and a decrease of combustion velocity of the injected fuel can obviously be seen. The rate of pressure rise, the value of the maximum pressure, and knocking are decreased, but the after-burning becomes severer and an increase of 3.8% in fuel consumption rate is concomitant. Curve *C* is the case of an increased amount and an advanced timing of pilot injection. There is not a large difference in the amount and timing of pilot combustion compared to the previous case perhaps because of an earlier timing of the injection. However, since the timing of fuel injection is advanced as a whole, the effect of pilot injection is not so clear compared to the case of *A*. A decrease of 1.6% in fuel consumption rate is obtained, because the whole timing of fuel injection is advanced and the constant-volume degree of combustion is increased.

Experiment (C) is the case when the two injection valves in Experiment (B) were exchanged each other. Since the sectional area of the nozzle of the horizontal automatic valve is small, the period of main injection becomes longer. Therefore, the pilot combustion occurs in the initial stage of main injection and the effect of pilot injection is more clear in this case. Furthermore, since the sectional area of the pilot injection valve is large, the amount of fuel injection becomes irregular when it is throttled to less than 8~9 mg per cycle. As a result, an amount of pilot injection less than that value not be used in this experiment. The fuel injection pump used for the main injection is a Mitsubishi type which has a fixed end of injection period.

Fig. 32 shows the result when Kogasin II was used as the pilot injection fuel. A large pilot combustion can be seen in this result. The combustion velocity of the main injection fuel is quite small, because the large pilot combustion occurs with the beginning of main injection. The fuel consumption rate is extremely increased in case *B*, since the nozzle area of the injection valve was too large to give a small amount of pilot injection and the pulverization of fuel was not good.

In the experiment shown in Fig. 33, a commercial light oil was

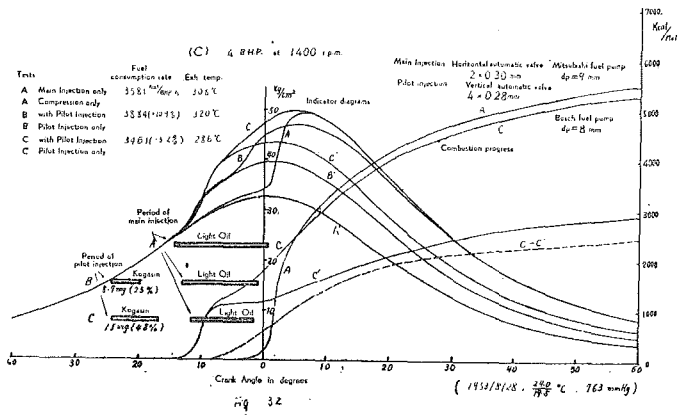

Fig. 32.

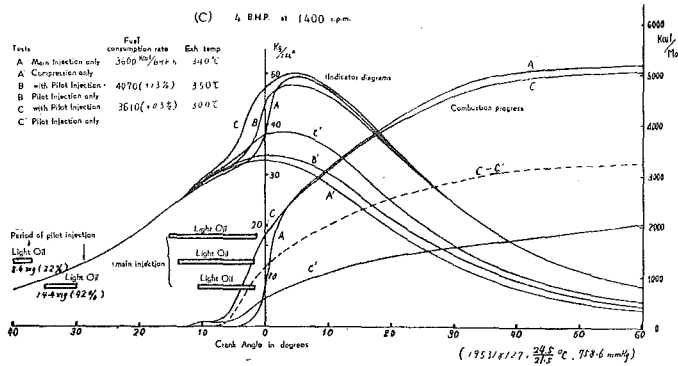

Fig. 33.

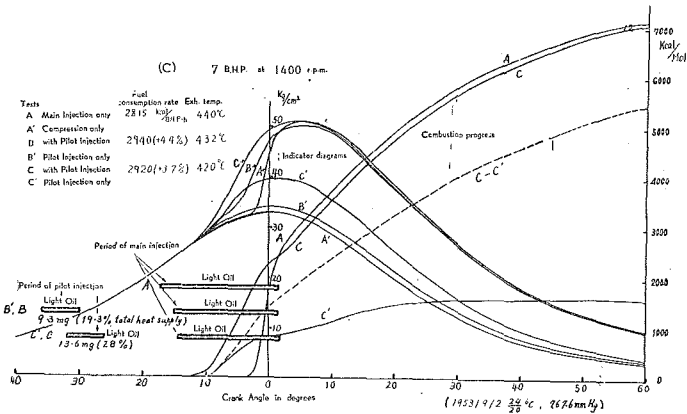

Fig. 34.

Figs. 32-34. Indicator Diagram and Combustion Progress in the case (C).

used for the pilot injection. A clear effect of pilot injection can be seen in this case, too. In case *B* an effective pilot combustion did not occur and the combustion is also quite bad as will be seen on curve *B'*, because the amount of pilot injection was too small for the injection valve used and an effective pilot combustion did not occur.

In Fig. 34, the timing of fuel injection in case *A*, which was used as the base of comparison, was selected at about the point of best thermal efficiency and the timing of injection in cases *B* and *C* is taken so that the constant-volume degree of combustion will also be favourable. Consequently, the comparison between these two cases can be said to present the best explanation of the effect of a pilot injection. As will be seen, an application of pilot injection obviously resulted in decreases of the rate of pressure rise and knocking. However, an increase of about 3% in fuel consumption rate occurs even in the case of the same maximum combustion pressure. When the maximum pressure is lower in the case with pilot injection, the increase of fuel consumption rate becomes of course larger. The reason for that exists in the lowering of combustion velocities of the main injection and the pilot injection fuels, which lowering prolongs the duration of combustion and decreases the thermal efficiency.

4. Conclusions.

(i) The employment of a pilot injection decreases the ignition lag of the main injection fuel, and the initial combustion velocity or the initial rate of pressure rise and knocking also decrease. In this case, the decrease of the initial combustion velocity is related to the degree of decrease of the ignition lag. It is necessary to make the ignition of the main injection occur at least before the end of injection in order to get an effective pilot injection.

(ii) Since the decrease of knocking by use of a pilot injection is related to the ignition lag of the main injection fuel, the combustion of that main injection fuel is also effected by the decrease of ignition lag in a similar manner to that explained in Study I in this paper. Namely, as the amount of fuel to be burnt at the initial stage of rapid combustion is decreased, the amount of fuel to be burnt later increases and the duration of combustion is prolonged. Looking more deeply, one can see that the fuel injection into the combustion gas of pilot injection and the shortening of ignition lag of the main injection fuel etc. result in a disturbance of mixing of the main injection fuel with

air because of the existence of a combustion gas and that of giving a preparation period to burn. As a result the duration of combustion is elongated. This fact that the duration of combustion is elongated fundamentally means a decrease of constant-volume degree of combustion and is necessarily accompanied by a lowering of thermal efficiency. To state it briefly, the ignition can be advanced but the whole combustion can not be promoted by injecting a fuel into the high temperature of the pilot combustion gas.

(iii) There is another reason for the decrease of thermal efficiency which accompanies by an application of pilot injection. When a small pilot injection is used, the combustion of the pilot injection fuel itself becomes very slow and an imperfect combustion sometimes follows, because the pulverization of the fuel is generally unfavourable. The degree of pulverization of the pilot injection fuel is appreciably related to the fuel consumption rate. Generally speaking, the less the amount of injection and the earlier the timing of injection, the worse the pulverization of fuel.

(iv) When the case with and without pilot injection are compared at their points of maximum thermal efficiency, the former is found to be superior in the points of a smaller rate of pressure rise and a lower maximum pressure, and the latter is better in the points of a shorter duration of combustion and a higher thermal efficiency. In the case without pilot injection, however, a retarded timing of fuel injection is practically used at the sacrifice of thermal efficiency for the purpose of decreasing the value of the maximum pressure. On the other hand, the timing of fuel injection for the maximum constant-volume degree of combustion can used in the case with a pilot injection, because the rate of pressure rise is small. Therefore, as a matter of practice, the comparison of thermal efficiencies is quite difficult. The comparison under the condition of the same maximum pressure, however, shows that a decrease of about 3% in thermal efficiency seems to be unavoidable when a pilot injection is used. The employment of pilot injection of course results in a smaller rate of pressure rise and a lower knocking, even if the maximum pressure is the same.

(v) As a matter of practice, a device of giving the pilot and main injections with one injection valve must be perfected, since the use of two injection valves is impractical. In this case, it is also quite a difficult problem to get a good pulverization of pilot injection for such a small amount of fuel. It may be concluded that the degree

of pulverization of the small pilot injection fuel is the key to the fuel consumption rate in a practical engine.

III. Combustion and Performance of a Diesel Engine with Pre-Combustion Chamber.

1. Preface.

It is generally said that a Diesel engine with pre-combustion chamber is insensitive to the timing of fuel injection. Practically, a certain amount of retardation of fuel injection does not yield a large effect on the fuel consumption rate. The indicator diagrams of the main combustion chamber of an engine with pre-combustion chamber already published also show that the timing of fuel injection is usually adjusted so that the pressure rise caused by combustion starts at around the T.D.C. The point, why the timing of injection is not selected so that the combustion starts early before the T.D.C. in order to attain a higher thermal efficiency by increasing the constant-volume degree of combustion, has attracted the present author's attention for a long time. It is also said that a reverse flow from the main combustion chamber to the pre-combustion chamber during the period of combustion occurs in an engine with pre-combustion chamber. The points—when this kind of reverse flow occurs and what kind of effect will result—have not been clarified.

Consequently, some experimental studies were undertaken at first in the study of these problems.

In former days, a pintle valve was used as the fuel injection valve, but it has been replaced by a throttle valve since about 1940. The advantage of using the latter is in the possibility of reducing the knocking by throttling the initial amount of injection. This advantage can naturally be expected in the case of an engine of direct injection type. However, exactly how is the throttle valve, and how is the combustion proceeding? These points are the second item to be studied.

Above in the section of Study I, the influence of cetane value upon engine performance was discussed in detail by using the experimental results obtained by operation of an engine of direct injection type. The influence of cetane value upon the combustion and the performance of an engine with pre-combustion chamber will also be explained.

2. Test engine and experimental method.

The engine employed for the experiment was of a single cylinder type as is shown in Fig. 35, where the dimensions of its combustion chamber are also given. The dimensions of the pre-combustion chamber and the connecting passage are almost the same as are usually found in ordinary automobile engines. The fuel injection pump and the fuel nozzle also have the same dimensions as are used for automobile engines of the same cylinder volume—the diameters of the plunger and the nozzle are 7 mm and 1 mm, respectively, and the cone angle of the nozzle is 4 degrees. These dimensions were employed in order to obtain the practical conditions of an actual engine.

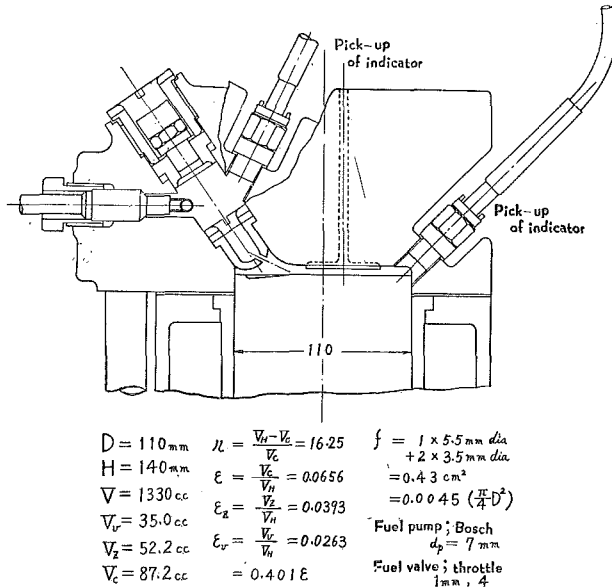

Fig. 35. Dimensions of the Combustion Chamber.

The experiments were undertaken at a constant speed of 1400 r.p.m. for two kinds of constant load of 10 BHP and 4 BHP by changing the timing of fuel injection. The indicator diagrams of both combustion chambers and the pressure difference between the chambers were recorded by electromagnetic oscillographs.

A commercial light oil of cetane value 53 was at first used in order to investigate the general items, and the influence of cetane value was studied by using secondary reference fuels in the next step. Finally, a number of experiments were performed to compare the effects of

a throttle valve and a pintle valve. The range of experiments is as follows:

Fuel valve	Load	Fuel	Test number	Indicator diagrams
Throttle valve	4	Light oil	(V)	Fig. 37 a
"	10	"	(VI), (XII)	Fig. 36 a, 36 b
"	"	SRF 50	(VII)	Fig. 38 b
"	"	SRF 70	(VIII)	Fig. 36 c
"	"	SRF 40	(XI)	Fig. 38 c
"	"	SRF 30	(IX)	Fig. 38 d
Pintle valve	4	Light oil	(XV)	Fig. 37 b
"	10	"	(XIII), (XVI)	Fig. 36 c, 36 d

A series of test number is assigned for convenience in explanation.

3. Experimental results and discussion.

The curves of fuel consumption rate for different timings of injection and ignition were obtained for each experiment, and a comparison of the performance was undertaken. Further, the apparent combustion progress was computed from the indicator diagrams of main combustion chamber, and the origin and the process of making a difference in performance were clarified. Some of the indicator diagrams of both combustion chambers were analysed to obtain the combustion progress in each chamber, and a detailed combustion progress was obtained.

Performance curves	Indicator diagrams and curves of combustion progress	Curves for explanation																		
Fig. 36 10 BHP Light oil	<table border="0"> <tr> <td rowspan="2">{</td> <td>Throttle valve</td> <td>VI</td> <td>.....</td> <td>1</td> </tr> <tr> <td></td> <td>XII*</td> <td></td> <td></td> </tr> <tr> <td rowspan="2">{</td> <td>Pintle valve</td> <td>XIII</td> <td>.....</td> <td>2</td> </tr> <tr> <td></td> <td>XVI*</td> <td></td> <td></td> </tr> </table>	{	Throttle valve	VI	1		XII*			{	Pintle valve	XIII	2		XVI*			Fig. 36'
{	Throttle valve		VI	1															
		XII*																		
{	Pintle valve	XIII	2																
		XVI*																		
Fig. 38 10 BHP Throttle valve	<table border="0"> <tr> <td rowspan="4">{</td> <td>SRF 70</td> <td>VIII*</td> <td>.....</td> <td>1</td> </tr> <tr> <td>" 50</td> <td>VII</td> <td>.....</td> <td>2</td> </tr> <tr> <td>" 40</td> <td>XI</td> <td>.....</td> <td>3</td> </tr> <tr> <td>" 35</td> <td>IX*</td> <td>.....</td> <td>4</td> </tr> </table>	{	SRF 70	VIII*	1	" 50	VII	2	" 40	XI	3	" 35	IX*	4	Fig. 38'	
{	SRF 70		VIII*	1															
	" 50		VII	2															
	" 40		XI	3															
	" 35	IX*	4																
Fig. 37 4 BHP Light oil	<table border="0"> <tr> <td rowspan="2">{</td> <td>Throttle valve</td> <td>V*</td> <td>.....</td> <td>1</td> </tr> <tr> <td>Pintle valve</td> <td>XV*</td> <td>.....</td> <td>2</td> </tr> </table>	{	Throttle valve	V*	1	Pintle valve	XV*	2	Fig. 37'									
{	Throttle valve		V*	1															
	Pintle valve	XV*	2																

* indicates the curves of combustion progress in each combustion chamber.

Besides, for the purpose of convenience in comparing the indicator diagrams and the combustion progress, figures of explanation are presented for the maximum pressure difference between the two combustion chambers, the period of reverse flow, the maximum combustion pressure, and the constant-volume degree.

The explanation of the results will be given by following the group headings shown below.

(i) Influence of the timing of fuel injection.

(A) Performance curves (comparison to an engine of direct injection type).

The curves of fuel consumption rate, exhaust gas temperature and the angle of ignition lag for various timings of fuel injection are shown in Figs. 36, 37 and 38. When these results are compared with those of an engine of direct injection type (Study I, in Fig. 14) with the same cylinder, revolution, and load, the following discussions can be derived:

(a) The ignition point (of the main combustion chamber) for the minimum fuel consumption rate is considerably retarded in comparison with that of an engine of direct injection type, and it is located at about $1^{\circ}\sim 4^{\circ}$ before the T.D.C. Detailed discussion will be given later. Since the angle of ignition lag is usually almost the same or slightly less than that of an engine of direct injection type, the timing of fuel injection for the minimum fuel consumption rate is also retarded.

(b) The influence of the timing of fuel injection upon the fuel consumption rate is seen to be rather larger than in the case of an engine of direct injection type when the performance curves of the two types are compared. Therefore, the possible range of the timing of fuel injection seems to be narrower for an engine with pre-combustion chamber, but a detailed study will prove that this is not really true. In the case of an engine of direct injection type, the point of ignition for the minimum fuel consumption rate is located considerably ahead of the T.D.C., and the gradient of the fuel consumption curve increases rapidly after around the T.D.C.

Since the pressure rise becomes steep and the knocking becomes severe when the timing of fuel injection is set for about selected at around the point of minimum consumption rate, the timing of injection is usually regulated so that the ignition occurs at around $2^{\circ}\sim 3^{\circ}$ before

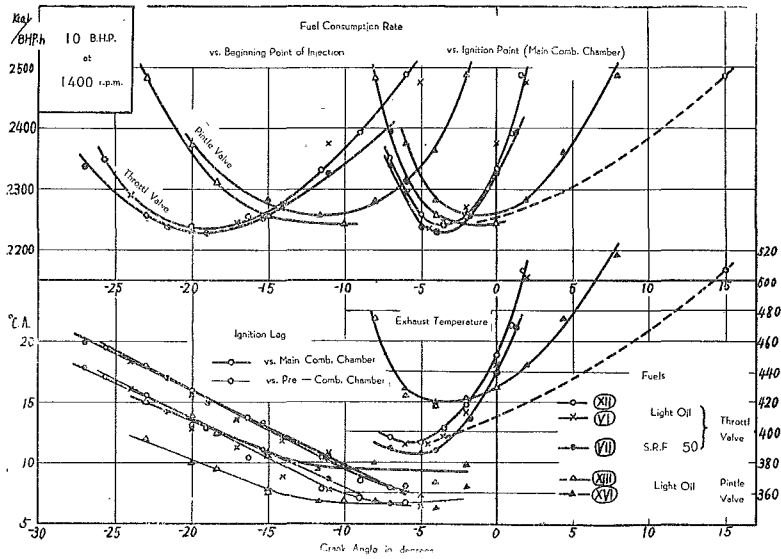

Fig. 36. Fuel Consumption Rate, Exhaust Temperature, and Ignition Lag.

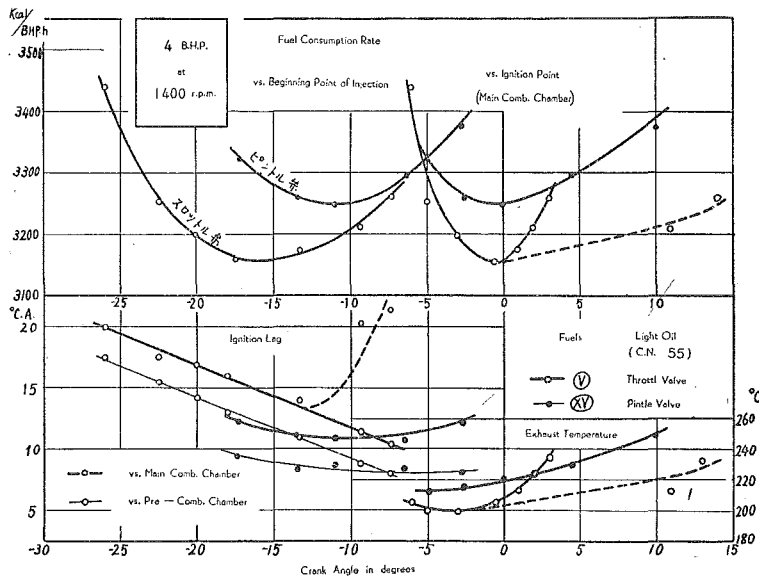

Fig. 37. Fuel Consumption Rate, Exhaust Temperature, and Ignition Lag.

the T.D.C. Therefore, the fuel consumption rate increases rapidly, if the timing of fuel injection is retarded from that position even a little. On the other hand, in the case of an engine with pre-combustion chamber, the point of ignition for the minimum fuel consumption rate is placed at around $1^{\circ}\sim 4^{\circ}$ before the T.D.C., and the pressure rise around that point is not very steep as will be seen on the indicator diagrams. Therefore, the timing of fuel injection for the sake of attaining the minimum fuel consumption rate is usually used for the practical purposes. Since the fuel consumption curve is almost flat around the point of the minimum fuel consumption rate, a small deviation of the timing of injection does not affect it. In this respect, the author believes that an engine with pre-combustion chamber is usually considered to be rather insensitive to the timing of fuel injection.

One can see on the curves of fuel consumption rate against the ignition point of an engine with pre-combustion chamber that they are rather steep in cases of both early and late timings of ignition. A rapid increase of fuel consumption rate for an early timing is caused by a rapid increase of cooling loss and a reverse flow from the main combustion chamber to the pre-combustion chamber. The detail of this reverse flow will later be further explained. Since the point of ignition is rather difficult to be exactly determined on the indicator diagrams of an engine with pre-combustion chamber, the curves of fuel consumption rate against various ignition points were obtained by determining the beginning of combustion from the computed result of combustion progress. The results obtained in this manner gave a steep slope at the side of retarded timing of ignition. In cases of retarded timing of fuel injection, however, there should be a period when a very small amount of fuel burns gradually at first, and a clear rapid combustion follows after that as will be seen on indicator diagrams or curves of combustion progress. Therefore, it might be reasonable to take the point of ignition as the beginning point of this main rapid combustion. The curves of fuel consumption rate obtained in this manner are indicated by broken lines.

(c) The angle of ignition lag for a pre-combustion chamber is smaller than for an engine of direct injection type, when it is compared with respect to the same timing of fuel injection, because the compression ratio is high. The angle of ignition lag for main combustion chamber is almost same as that of an engine of direct injection type when the timing of injection is early, but it becomes smaller when

that timing is retarded. There is a difference of about 2° in crank angle between the ignition points for main and pre-combustion chambers, even if that difference varies slightly with the kinds of fuel.

The significant point of the ignition lag for an engine with pre-combustion chamber exists in a larger variation of ignition lag against the timing of fuel injection than in the case of an engine of direct injection type. This is a result of the increases of pressure and temperature in the pre-combustion chamber at around the point of fuel injection which are larger than in the case of an engine with single combustion chamber. These increases of pressure and temperature are caused by the severe inflow of the working medium into the pre-combustion chamber.

In the cases of pintle valves, the angle of ignition lag considerably decreases compared to the cases of throttle valves and the variation of ignition lag against the timing of fuel injection also decreases appreciably, because the ignition lag is related to the amount of fuel initially injected.

(B) General discussion of indicator diagrams.

A series of indicator diagrams obtained by changing the timing of fuel injection for each experiment is shown in Figs. 36 a, b, c, d, 37 a, b and 38 a, b, c, d. A remarkable variation of the forms of indicator diagram can be seen in these figures as a result of slight changing of the timing of fuel injection. In the case of an engine of direct injection type, a rapid pressure rise appears even for a considerably retarded timing of fuel injection, but in an engine with pre-combustion chamber a slight retardation of fuel injection causes a rapid decrease of the maximum combustion pressure and finally it becomes not to exceed the compression pressure. Even in this case, there is not a remarkable increase of fuel consumption rate. This kind of matter can not be experienced for an engine of direct injection type, and the present author was rather surprised to notice that the fuel consumption rate was not so bad even under the condition of such a strange indicator diagram. Therefore, an investigation of the origin of this phenomenon was first undertaken.

As the first step, a number of apparent combustion progresses were computed from the indicator diagrams of main combustion chamber, and the general aspects of this phenomenon became almost clear. Therefore, the conclusions obtained by looking over these series

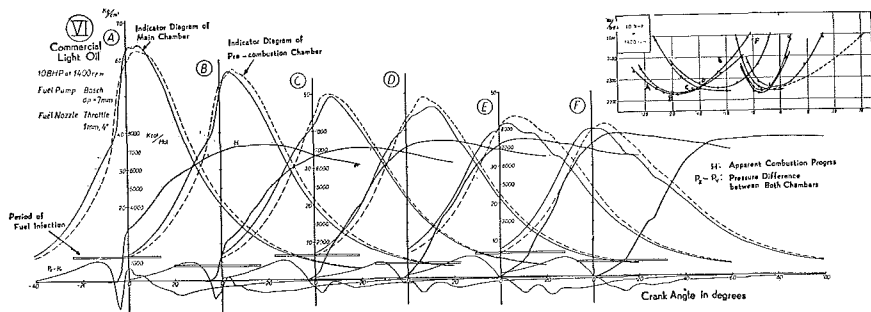

Fig. 36 a.

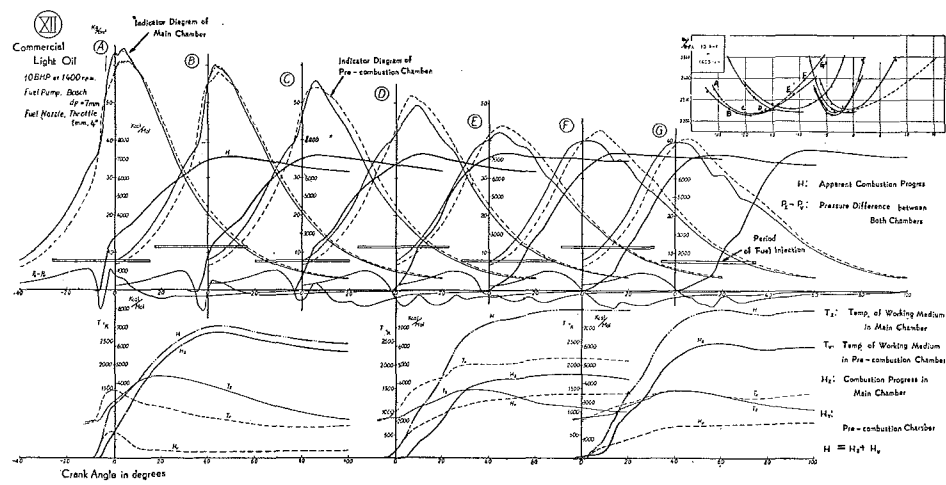

Fig. 36 b.

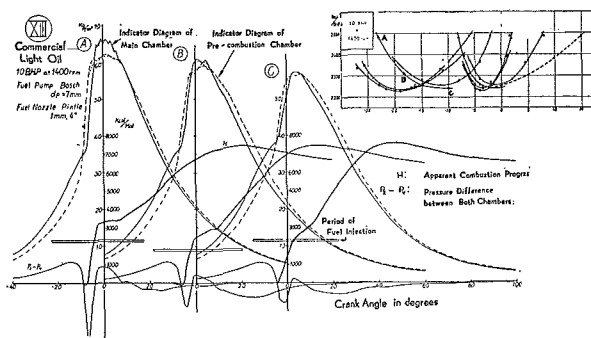

Fig. 36 c.

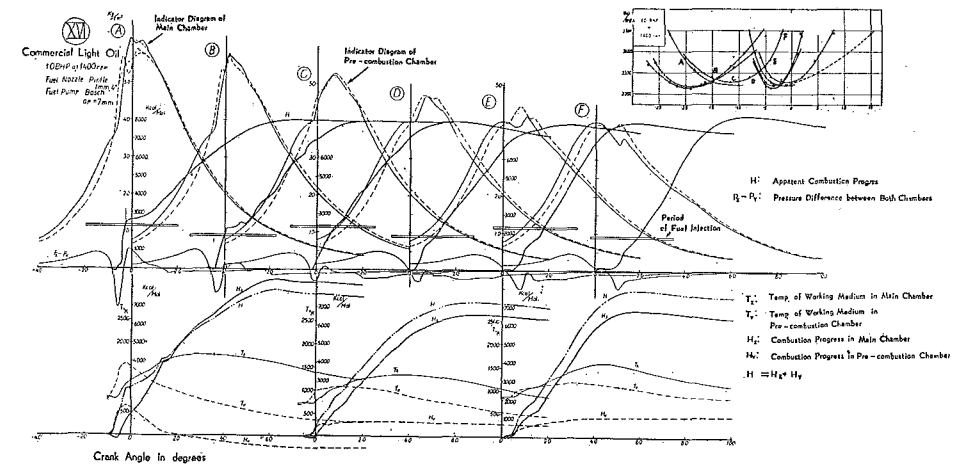

Fig. 36 d.

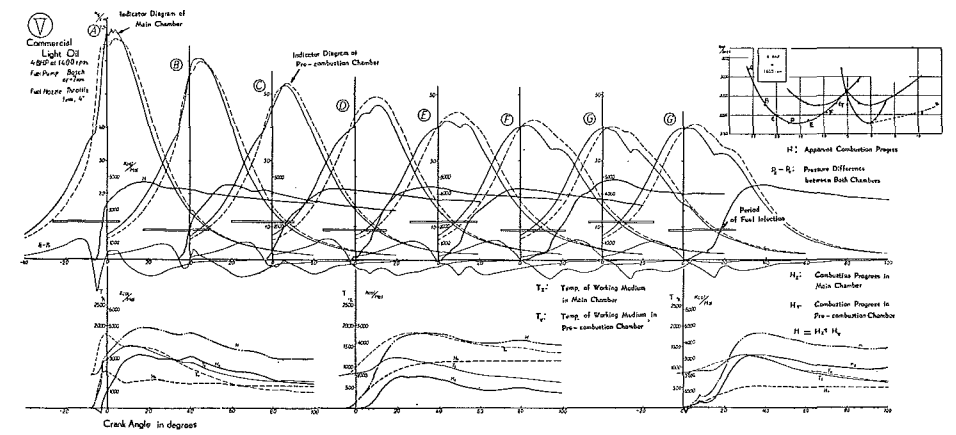

Fig. 37 a.

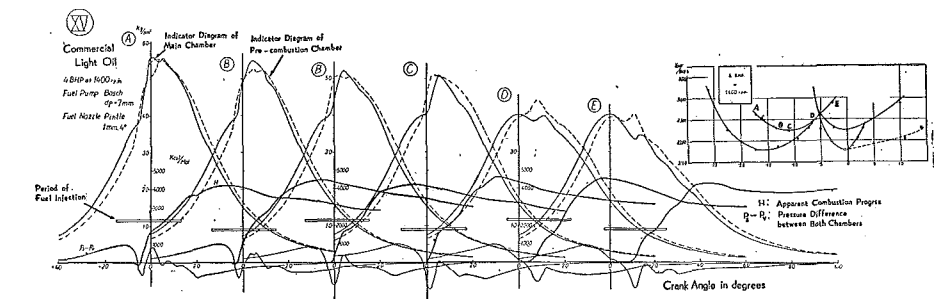

Fig. 37 b.

Figs. 36 a-36 d. Indicator Diagram and Combustion Progress.

Figs. 37 a-37 d. Indicator Diagram and Combustion Progress.

of indicator diagrams and apparent combustion progresses will be described at first without going into the detailed explanation about each of them.

(a) Pressure difference between the two combustion chambers.

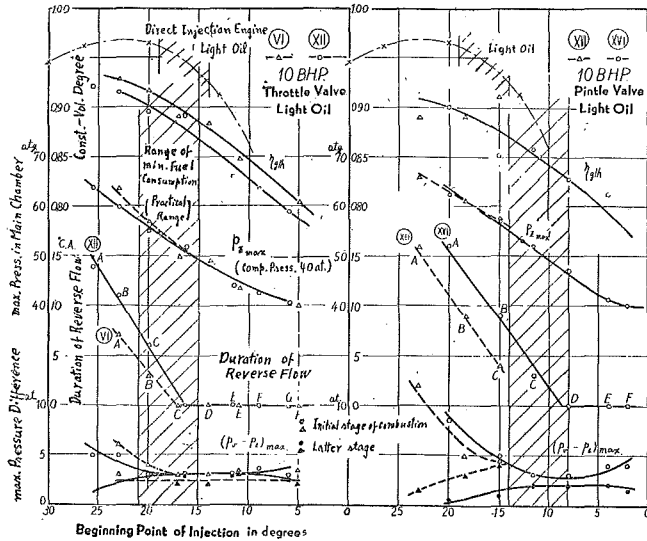

Fig. 36'. Curves for Explanation.

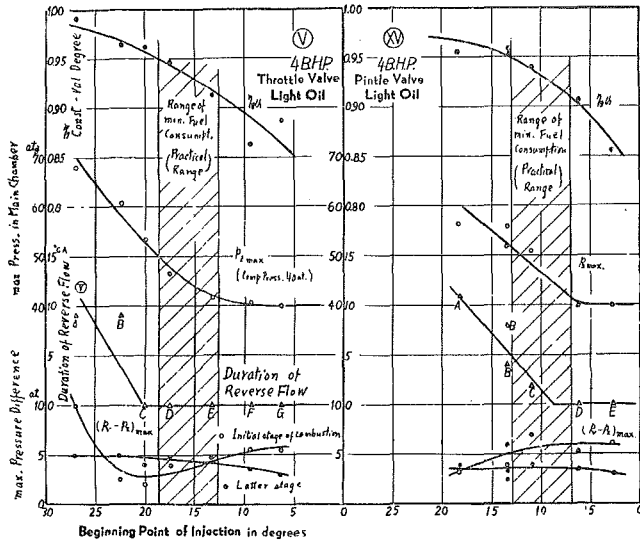

Fig. 37'. Curves for Explanation.

The pressure difference between main and pre-combustion chambers during the combustion period can not become very large when the ordinary dimensions of connecting passage and the fuel injection system are employed.

The maximum pressure differences are shown in Figs. 36', 37' and 38', dividing the period of combustion into two parts, initial and later. It sometimes happens that the pressure difference of about 6~10 at. appears just for a short time at the initial part of combustion when the timing of injection is willfully advanced. However, the maximum pressure difference that appears between the two chambers is almost the same or less than the one that occurs during the compression stroke, when the timing of fuel injection is selected in the range usually used. Therefore, when a usual timing is used, the kinetic energy of the inflow from the pre-combustion chamber into the main chamber is not very large, and the distribution of the fuel would not be very good in a flat type of main combustion chamber. This fact was already proved by Schnickich⁽¹⁾ after his analysis of the gases taken from various parts of the main combustion chamber. The thermal efficiency and output of an engine have been improved in Japan since several years ago by changing the shape of main chamber into a type constructed around the connecting passages. The fundamental reason of these improvements exists in the supplement of small kinetic energy by the change of combustion chamber.

(b) Combustion velocity.

Looking at the diagrams of combustion progress obtained from the indicator diagrams of the main combustion chamber, one can see that there is almost no difference in the combustion velocity of the main part of the combustion process even in the cases of strange indicator diagrams. There is also no difference in the after-burning. Accordingly, there was not an extreme increase in fuel consumption rate, even if the timing of fuel injection were retarded so that the main part of combustion would begin as late as 15° ~ 20° after the T.D.C. Of course, a decrease of constant-volume degree by the shift of the period of combustion to the side after the T.D.C. as a whole and a little increase of the fuel consumption rate would accompany. Still, such a decrease of constant-volume degree were comparatively small as will be seen on the curves of $\eta_{q_{th}}$ in Figs. 36', 37' and 38'. These

(1) "Die Verbrennung im Vorkammermotor" A.T.Z., Jg 34, Ht 25/4/1940.

kinds of phenomena can not be seen in an engine of direct injection type. These results may be brought about originated by the inflow of very unstable activated fuel into the main chamber, because the fuel is thermally cracked by the high temperature in pre-combustion chamber.

The above results are noteworthy features of an engine with pre-combustion chamber from the standpoint of the combustion process, and they also account partially for the insensitiveness of this type of engine to the kind of fuels. Since the injection of the unburnt fuel into the main combustion chamber in an engine with pre-combustion chamber is similar to the air injection of fuel in an air injection Diesel engine, the purposes have been forwarded only to the point of obtaining a good distribution of fuel. However, a design of combustion chamber must be perfected hereafter which will make use of the characteristics described above.

(c) Point of minimum fuel consumption and reverse-flow phenomena.

It has already been clarified that the ignition point for the minimum fuel consumption rate exists at a point far later than in the case of an engine of direct injection type, and that it is located at about $1^{\circ}\sim 4^{\circ}$ before the T.D.C. However, that the fuel consumption rate would become minimum under this condition can not be expected from the standpoint of constant-volume degree of combustion. For the purpose of investigating the origins of this peculiar result, the timing of fuel injection was advanced. When the timing of fuel injection was forced to advance, a severe noise naturally accompanied, but the most troublesome points encountered were the high temperature of the combustion gas that flows out from the pre-combustion chamber and repeated failures in respect of valve leakage caused by a thermal deformation at the exhaust valve part, where the gas of high temperature hits directly. Another difficulty in the continuation of the experiment was that the same fuel consumption rate could not be obtained so easily as before when the timing was once advanced in this manner. This all means that the engine was overheated to a considerable extent. Therefore, the main part of the reason that a decrease of thermal efficiency originated against the intention of improving the constant-volume degree seems to be a large amount of cooling loss. This is an acceptable matter in an engine with pre-combustion chamber which is accompanied by a violent flow of gas.

A reverse flow into the pre-combustion chamber caused by the high pressure produced in the main combustion chamber during the period of combustion is also a matter to be considered. The reverse flow occurs only at the time when the timing of injection is advanced and it becomes severer with the degree of advancement of the timing of fuel injection. The reverse flow does not occur at all when the timing of fuel injection is late. The point of the minimum fuel consumption rate is located at around the border where the reverse flow begins to occur as will be seen from Figs. 36', 37' and 38'. The loss of the reverse flow is composed from the throttling loss and cooling loss that occur when the combustion gas ready to work in the main combustion chamber flows back into the pre-combustion chamber. While the reverse flow is occurring the outflow of fuel from the pre-combustion chamber stops, and the object of increasing the constant-volume degree must necessarily be sacrificed.

Looking at the diagrams of combustion progress, one can see that just after the reverse flow it becomes usually slow, and that the end of combustion is also retarded in some diagrams. The temperature of exhaust gas also presents evidence for this fact by showing a tendency to increase when the timing of fuel injection is extremely advanced.

(d) Constant-volume degree of combustion.

The constant-volume degree of combustion was computed upon the basis of the following equation by using the diagrams of the apparent combustion progress that were derived from the indicator diagrams of main combustion chamber. The results are shown in Figs. 36', 37' and 38'.

Constant-volume degree of combustion:

$$\eta_{oth} = \frac{1}{H} \int \frac{dH}{d\alpha} \eta_{oi\alpha} \cdot d\alpha$$

where

H = total amount of combustion heat

α = crank angle

$\eta_{oi\alpha}$ = rate of lowering of thermal efficiency at an arbitrary position of combustion,

$$= 1 - \frac{1}{r_{\alpha}^{k-1}} \bigg/ 1 - \frac{1}{r^{k-1}}$$

r_{α} = compression ratio at an arbitrary position of combustion

$$\begin{aligned}\eta_{th} &= \text{theoretical thermal efficiency} \\ &= 0.580 \text{ (for } r = 16.25, \lambda = 1.8) \rightarrow k = 1.311.\end{aligned}$$

For reference, the values of constant-volume degree obtained in the section of Study I for an engine of direct injection type under the conditions of the same output and fuel are transferred to these figures.

Comparing these two curves of constant-volume degree, one can see that the gradient of the curve is not steeper for an engine with pre-combustion chamber than in the case of an engine of direct injection type, when the timing of fuel injection is retarded from the position practically and usually used. This is also one of the reasons that an engine with pre-combustion chamber is insensitive for the timing of fuel injection.

The comparison between these two types of engines at the position of fuel injection practically used also shows that the constant-volume degree of an engine with pre-combustion chamber is considerably lower than that of an engine of direct injection type. The thermal efficiency of an engine with pre-combustion chamber is worse than that of an engine of direct injection type because of the losses of throttling and cooling as well as the lowering of the constant-volume degree of combustion. However, the lowering of constant-volume degree should not be understood as an unfavorable result, since it was caused by retarding the beginning point of combustion but not by the increase of after-burning. Looking at the series of the diagrams of combustion progress, one can see that a rapid pressure rise appears at the initial stage of combustion and the cooling loss increases, when the timing of fuel injection is early, and that a worthless lowering of constant-volume degree occurs as there is a part of very slow combustion at the initial stage of combustion, when the timing of injection is retarded. It is also obvious that the combustion proceeds at a uniform velocity from the beginning to the end in the neighborhood of the point for the minimum fuel consumption rate. This kind of combustion may be deemed as preferable for an internal combustion engine. The problem of advancing the period of combustion without failing to maintain this sort of good progress of combustion is still remains to be settled.

(ii) Effect of cetane value of fuel.

The experimental results for various cetane values of fuel are shown in Figs. 38, 38', and 38a, b, c, d. From these results, the fol-

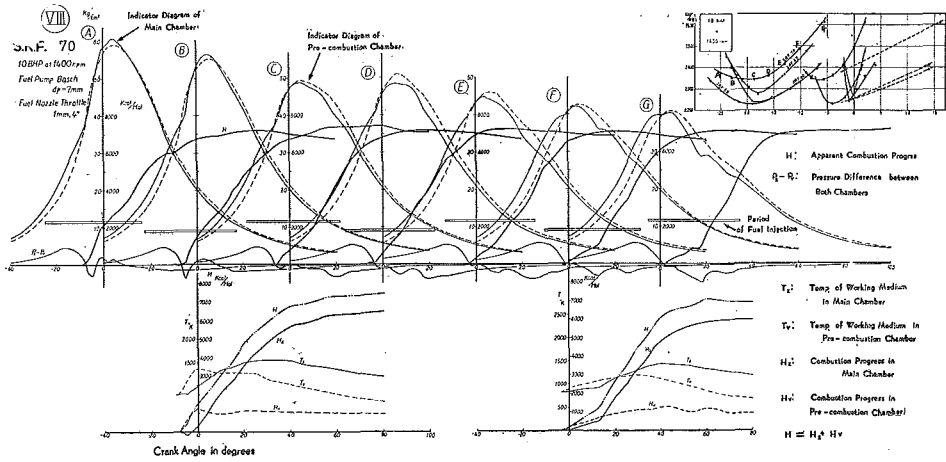

Fig. 38 a.

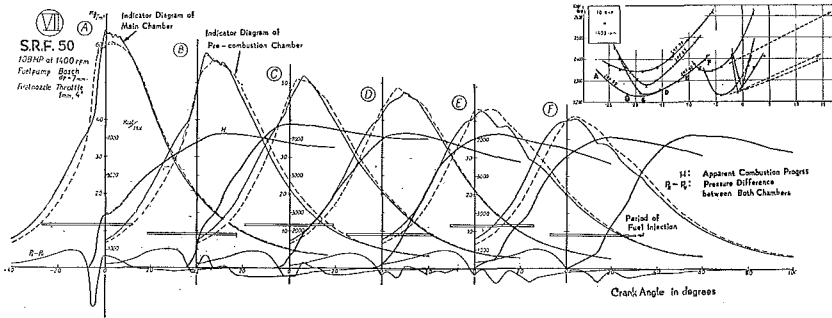

Fig. 38 b.

lowing discussions can be derived as to the effects of cetane value.

(a) Indicator diagrams and the pressure difference between the two combustion chambers.

The lines of pressure rise caused by combustion in both combustion chambers approach very near in the case when a fuel of high cetane value is used, and the two lines are somewhat apart when the cetane value of fuel is low. Therefore, the pressure difference between the two chambers is comparatively small in the former case, and it is comparatively large for the latter.

In the case of a high cetane value, the initial rate of pressure rise in the pre-combustion chamber is slight, since the ignition lag is small. If the pressure rise in pre-combustion chamber is gradual, the pressure

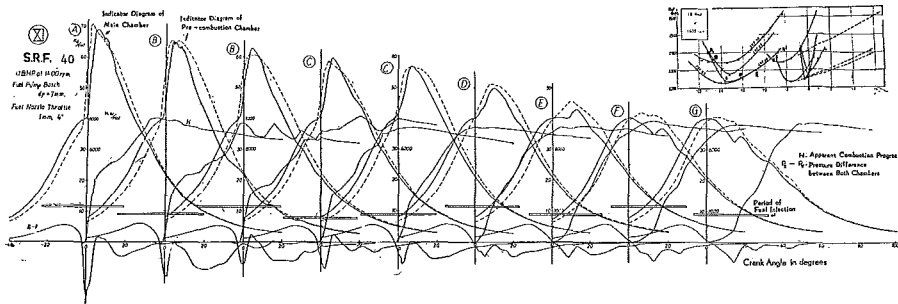

Fig. 38 c.

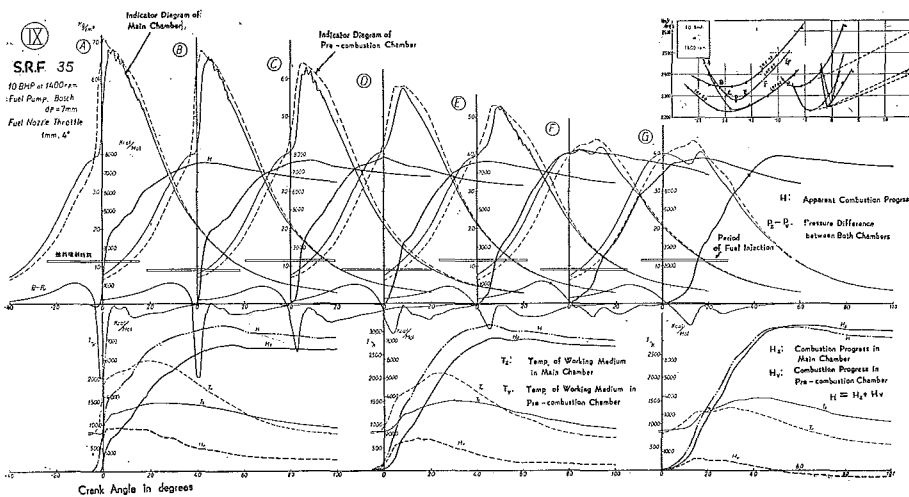

Fig. 38 d.

difference between the two chambers must be small. Furthermore, if the cetane value of a fuel is high, its ignition property and combustibility may be good even at the time when it flows into the main combustion chamber and the combustion will proceed continuously. Consequently, the indicator diagrams for these two chambers naturally have a tendency to approach each other, and the pressure difference between the two chambers becomes small.

On the contrary, in the case of a low cetane value fuel, the pressure rise in the pre-combustion chamber is quite rapid and the pressure difference becomes comparatively large.

The initial rate of pressure rise in the main combustion chamber becomes almost the same as that in pre-combustion chamber, when

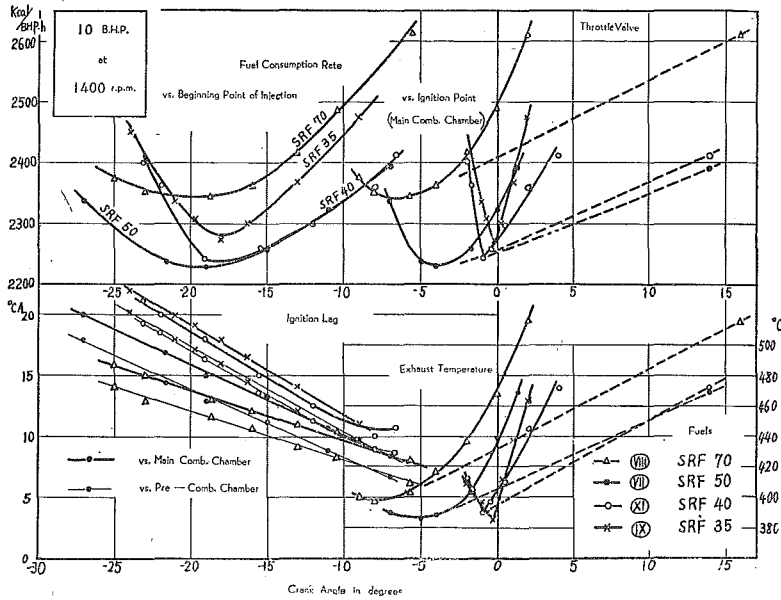

Fig. 38. Fuel Consumption Rate, Exhaust Temperature, and Ignition Lag.

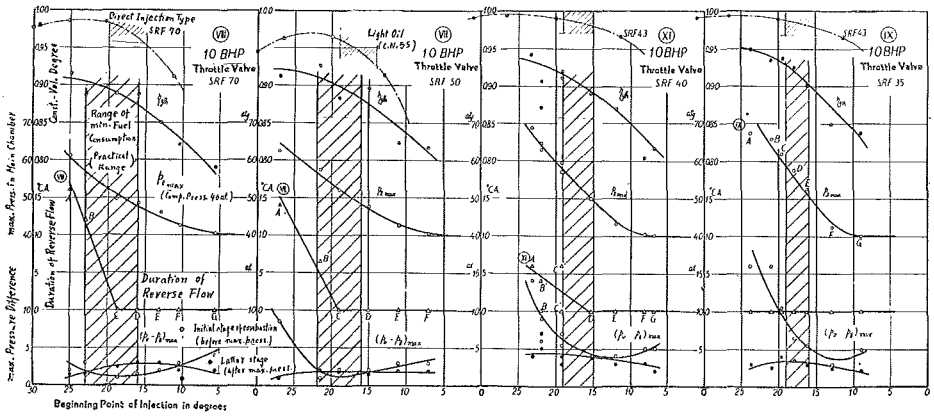

Fig. 38'. Curves for Explanation.

the connecting passage between the two chambers is comparatively large as is the usual case. The latter part of pressure rise in main combustion chamber differs by the progress of combustion, and the maximum pressure sometimes exceeds the maximum value of the pressure in pre-combustion chamber in certain cases of fuel and injection timing.

(b) Reverse flow.

The change of the duration of reverse flow in correspondence to various timings of fuel injection is shown in Fig. 38'. A reverse flow does not occur in the case of a late timing of fuel injection. In the case of an advanced timing of injection, the duration of reverse flow rapidly increases for a fuel of high cetane value; its increase is not so large for a fuel of low cetane value. When a fuel of SRF 35 is used, the reverse flow did not occur even if the timing of injection was considerably advanced. As will be seen on indicator diagrams, in the case of high cetane value, the pressure rise in pre-combustion chamber and the pressure difference between the two chambers are comparatively small and the pressure resulting from combustion in main chamber easily exceeds the pressure in pre-combustion chamber. For a fuel of low cetane value, on the other hand, the pressure in main chamber can hardly exceed the pressure in pre-combustion chamber, since the pressure rise in the latter is very large and the combustibility of the unburnt fuel in the former is not very good.

(c) Apparent combustion progress.

The comparison of the diagrams of combustion progress for fuels of various cetane values shows that the combustion velocity of the main part of combustion, after the initial rapid one, is large and that the combustion finishes early, when the cetane value of fuel is low. These results may seem to be against the ignition property and the combustibility. However, the combustion velocity was promoted because of the large pressure difference between the chambers, which resulted in an increase of fuel inflow into main chamber and of the possibility of distributing the fuel into air. Also, the duration of reverse flow governs the combustion velocity of the main part of combustion when the timing of fuel injection is early. In the case of a fuel of SRF 35, for example, the combustion velocity at the main combustion is appreciably large and the combustion finishes early, since the pressure difference between the two chambers is large and since there is no reverse flow. However, in the case of SRF 70, the combustion is slow and the constant-volume degree is also small.

(d) Performance curves.

The comparison of performance curves is shown in Fig. 38.

The main reasons for the higher fuel consumption rate in the use

of a fuel of high cetane value exist in an insufficient distribution of fuel into air due to the small pressure difference between the two chambers, a low combustion velocity, and a low constant-volume degree.

In the case of low cetane value fuels, the pressure difference between the chambers is large, and the distribution of the fuel is good. Also, there is not a large reverse flow in this case. Consequently the constant-volume degree of combustion is high, but the flow of gas becomes severe, and the cooling loss increases. Thus a tendency of increasing the fuel consumption rate results. Especially when the timing of fuel injection is early, the combustion becomes very rapid, and a vibration of gas in the combustion chambers appears (especially in the main chamber) and the cooling loss extremely increases. Therefore, the fuel consumption rate increases very rapidly.

A fuel of about 50 cetane value is the case between these extreme cases, and it gives the best fuel consumption rate. The reasons may be that the size and the form of the pre-combustion chamber and the size of the connecting passage employed in practical engines were determined by testing with a commercial light oil of about 50 cetane value.

In the case when a fuel of high cetane value is used, it is necessary to make the connecting passage small and the pressure difference between both chambers must be large. The distribution of fuel in main combustion chamber must also be good in this case. When a fuel of low cetane value is used, on the other hand, the connecting passage must be large and the pressure difference between the two chambers must be small so that an extreme increase of cooling loss would be prevented.

(e) Comparison of the point of minimum fuel consumption rate.

As was described above in the section of "Influence of the timing of fuel injection", a late timing of fuel injection lowers the constant-volume degree. If the timing of injection is advanced in order to increase the constant-volume degree, an extremely large cooling loss and a reverse flow occur, and the purpose of improving the constant-volume degree can not be effectively attained. Therefore, the timing of injection for the minimum rate of fuel consumption is not located at the position of the maximum constant-volume degree, but it is placed near the position where a reverse flow begins to start. Furthermore, the pressure rise resulting from combustion is not so severe for this

timing of injection, so it can be used for a practical operation. This best timing of injection is almost the same for all cetane value, and the same timing of injection can be used even if that value of fuel is changed.

(iii) Throttle valve and pintle valve.

The rate of injection by the fuel injection valve was as shown in Fig. 39 at the fuel pump revolution of 700 r.p.m. for the amount of injection equivalent to 10 HP output, when the valve was tested by injecting a fuel into open air. The measurement was performed by receiving the injected fuel in a number of thin cells arranged around a disc running with a high speed.

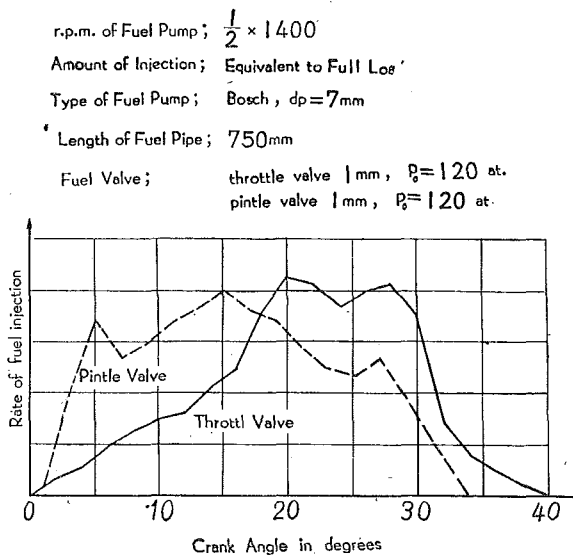

Fig. 39. Measurement of Fuel Injection Rate.
(Injected into Open Air)

The comparisons of performances of an engine with throttle valve or pintle valve are shown in Figs. 36, 36', 37 and 37'. From these experimental results, the following conclusions can be derived.

- (a) Initial stage of combustion (rate of pressure rise and maximum pressure on indicator diagrams).

The effects of a throttle valve evidently appear at the initial stage of combustion in a pre-combustion chamber; both the rate of pressure

rise and the maximum pressure are low. However, since the period of fuel injection is usually longer ($35^{\circ}\sim 40^{\circ}$ crank angle for the full load) in the case of an engine with pre-combustion chamber compared to an engine of direct injection type, the pressure rise at the initial stage of combustion is originally not so large.

In Fig. 40, the points of ignition in pre-combustion chamber with a throttle valve in Experiment (XII) and those with a pintle valve in

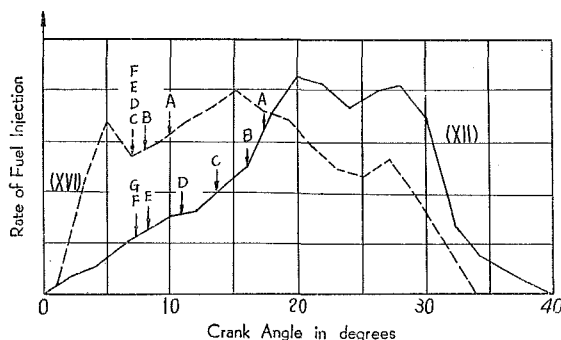

Fig. 40. Ignition Point noted on the Fuel Injection Curve in the Cases of Experiment (XII), (XVI).

Experiment (XVI) are indicated on the curves of fuel injection rate. One can see, in this figure, that the amount of fuel injected before the ignition is about $1/5\sim 1/3$ of the total fuel to be injected, which is not very large. It may be worth-while to note that the amount of fuel to be injected before the ignition is almost the same in both cases at point *C* where the fuel consumption rate is minimum. This unreasonable result was obtained perhaps because the test was carried out by injecting the fuel into open air. In the case of a practical injection into a cylinder, the effect of throttling of a throttle valve would appear.

Since the sectional area of the connecting passage between the two chambers is comparatively large and the pressure rise in pre-combustion chamber promptly appears also in the main chamber, the pressure rise in the latter is rapid when a pintle valve is used. However, the initial rate of combustion in the main chamber does not differ in cases of both a throttle valve and a pintle valve as will be seen in the diagrams of combustion progress in each chamber.

(b) Latter stage of combustion.

When a throttle valve is used, the combustion after reaching the

point of maximum pressure, which occupies more than $2/3$ of the total fuel, gives a larger pressure difference between the two chambers, a larger rate of combustion, an earlier end of combustion, a higher constant-volume degree, and a better thermal efficiency. (ref. the apparent combustion progress in Figs. 36 a, b, c, d, 37 a, b, and Figs. 36', 37').

- (c) Comparison at the point of the minimum rate of fuel consumption.

The point of the minimum rate of fuel consumption represents a good measure for the comparison between the two cases, since the pressure rise at this point is not so rapid and the timing of injection for the minimum fuel consumption rate can be practically employed.

The ignition points for the minimum fuel consumption rate at full load are about 4° and $1^\circ\sim 2^\circ$ before the T.D.C. when a throttle valve and a pintle valve are used, respectively. As the pressure rise is rapid and the cooling loss is large when a pintle valve is used, the point of ignition must be retarded. In the case of a light load, the cooling loss does not change very much even if the amount of fuel is decreased. Therefore, the point of ignition for the minimum rate of fuel consumption was retarded in comparison to that of full load, and the ignition points for a light load of 4 BHP were found at about 1° before the T.D.C. for both types of fuel valves.

A pintle valve gives a worse fuel consumption rate, which comes from a large cooling loss and a lower constant-volume degree of combustion.

Fig. 41 is given for the purpose of comparing the fuel injections with the two valves by arranging the diagram of injecting rate of

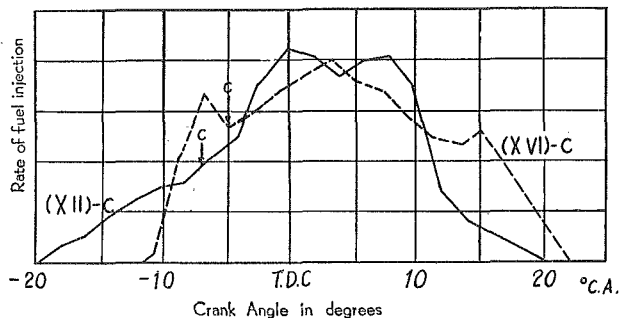

Fig. 41. Period of Fuel Injection and Ignition Point of Min. Fuel Consumption in Experiment (XII), (XVI).

the two types of valves so that the beginning points of fuel injection and ignition would coincide with those for minimum fuel consumption rate. One can see, in this figure, that the end of fuel injection of a pintle valve is later than the one of a throttle valve. As a result, the constant-volume degree and the thermal efficiency may have lowered, when a pintle valve was used.

As will be seen from Indicator Diagrams (V)—*D* in Fig. 37 a and (XV)—*C* in Fig. 37 b, the point of cut-off of fuel injection for a pintle valve is also later than that for a throttle valve, when the output is 4 BHP.

Furthermore, the difference of fuel consumption rates for these two cases becomes larger when the output is small, because the percentage of cooling loss becomes large.

(iv) Combustions progress in each combustion chamber.

The combustion progress in each combustion chamber was computed for each three representative indicator diagrams with regard to the following experiments.

Fig. 36 b (XII)	10 BHP,	throttle valve,	commercial light oil
Fig. 36 d (XVI)	" ,	pintle valve,	"
Fig. 38 a (VIII)	" ,	throttle valve,	SRF 70
Fig. 38 d (IX)	" ,	" ,	SRF 35
Fig. 37 a (V)	4 BHP,	" ,	commercial light oil

It is rather difficult to reach detailed conclusions out of this limited number of experiments. Still, the following points at least were clarified:

(A) Combustion in pre-combustion chamber.

(a) The volume of the pre-combustion chamber occupies 40% of the total clearance volume, and the amount of air contained is sufficient to burn about 70% of the fuel for full load ($1.8 \times 0.4 = 0.72$ with $\lambda = 1.8$). However, only about 20~30% of the fuel for the full load is burnt in the pre-combustion chamber. The absolute amount of fuel to be burnt in that chamber was almost constant without regarding to the magnitude of load. However, a detailed comparison of combustion progress will show that the amount of fuel burnt seems to have a tendency to increase when the output is small because of a large ignition lag. (cf. Indicator Diagram (V) in Fig. 37 a).

(b) The combustion in the pre-combustion chamber is governed mainly by the ignition lag.

In the case of an early timing of fuel injection, a rapid combustion at first occurs because of the large ignition lag, and the fuel injected thereafter into the pre-combustion chamber flows into the main chamber with the lowering of pressure in the main chamber without undergoing a significant combustion.

In the case of a retarded timing of fuel injection, the initial combustion is less rapid because of a small ignition lag, and the amount of the total combustion in the pre-combustion chamber usually becomes small by a gradual progress of combustion.

When the timing of fuel injection is properly selected, the combustion rate is also proper and the total amount of combustion in pre-combustion chamber is usually large.

In the case of an extremely advanced timing of injection, however, a severe reverse flow usually occurs at the same time and a decrease of total amount of combustion in pre-combustion chamber is generally noticed. The reverse flow seems to have a trend to restrict the combustion in pre-combustion chamber.

(B) Combustion in main combustion chamber.

(a) The beginning point of combustion in main chamber appears about 2° in crank angle after the ignition point in pre-combustion chamber. There should not be an ignition lag as large as 2° , because the working medium with unburnt fuel flows into the main chamber as a flame so that the combustion would proceed continuously. This discrepancy should perhaps be attributed to the position of the pick-up of indicator. The pick-up arranged for the main chamber was placed at the side opposite to the connecting passage. If the sound velocity of 750 m/s is assumed for the propagation of pressure wave in the gas in cylinder, the duration of traversing the cylinder should be 1.22° in crank angle at the engine speed of 1400 r.p.m.

(b) There are two clearly different stages: initial (period until the maximum pressure is attained) and later (period after the maximum pressure) in the diagrams of apparent combustion progress computed from the indicator diagrams of main combustion chamber. When the timing of fuel injection is early, the initial stage of combustion is quite rapid, contrariwise it is very slow when the timing is retarded. In the case of properly selected timing of fuel injection, there is no

difference in the rate of combustion in these two stages and the combustion progresses uniformly at a proper rate.

An apparent combustion progress includes the combustion in pre-combustion chamber indirectly as well as the combustion in main chamber. The actual combustion progresses which proceed in the main chamber are shown on the diagrams of combustion progress in each chamber. It can also be seen, in these diagrams, that the rate of combustion is almost the same in these two stages of combustion and that the combustion is proceeding at almost the same rate from the beginning to the end of combustion. Also, this combustion progress is almost independent of the timing of fuel injection and the cetane value. (When the timing of fuel injection is late, there is a period of very slow combustion at the initial stage of the combustion progress in main chamber. As will be judged from the location of the ignition point indicated on the diagram of fuel injection rate already shown in Fig. 40, this period of gradual combustion must result, because the ignition occurs mid-way of the throttling of the throttle valve and the rate of injection is quite small for a little while. After the period of throttling, a similar combustion of high velocity also appears).

The fact that the combustion rate in main chamber is always almost uniform without regard to the timing of fuel injection is an important feature of an engine with pre-combustion chamber. In the case of an engine of direct injection type, the combustion becomes very slow and the after-burning becomes severe when the fuel injection is retarded, because the combustion occurs at a comparatively late stage of expansion stroke where the temperature and pressure are low. However, the fact that the combustion rate is almost the same even for a retarded timing of injection in an engine with pre-combustion may mean that the fuel enters into the main combustion chamber at such an activated state that a certain lowering of pressure and temperature can be neglected. It can also be understood that the fuel gathered at the narrow top of pre-combustion chamber is thermally cracked by a high temperature under the condition of insufficient air, and it becomes to be in an unstable and activated state.

The distribution of fuel into air is also deeply influences the combustion rate. The good distribution of fuel in main combustion by the large mixing ability of gas entering into the main chamber can also be one of the reasons for the preferable combustion described above. Also, the combustion progress in main chamber must be related

to the amount of fuel flowing into the chamber.

The velocity of fuel inflow into the main combustion chamber is primarily governed by the velocity of injection from the fuel valve, even in the case of an engine with pre-combustion chamber. Therefore, the combustion rate had to be almost the same when the same injecting apparatus was used. However, the amount of fuel is also governed to some extent by the injecting velocity of gas from the pre-combustion chamber. At the same time, the ability of mixing with air is entirely dependent upon the injecting velocity of gas. Therefore, the combustion in main combustion chamber must be related to the pressure difference between both chambers. The pressure difference between the two chambers in the latter stage of combustion, where the main part of combustion occurred, was almost the same, but it became a little larger when a fuel of low cetane value was used. As a result, the rate of combustion was slightly increased by this effect of a little larger pressure difference in this case.

4. Conclusions.

As answers to the problems proposed in the preface to this chapter, the following conclusions can be derived from the above discussions:

(i) In the case of an engine with pre-combustion chamber, the ignition point for the minimum fuel consumption rate is considerably late compared to that of an engine of direct injection type. It is nearby at the T.D.C. The constant-volume degree of combustion is bad for this timing of ignition. Even if the ignition point is further advanced, however, an extremely large cooling loss resulting from a rapid pressure rise, a severe reverse flow, and an increasing fuel consumption rate can not be avoided.

(ii) An engine with pre-combustion chamber is insensitive to the timing of fuel injection, because the timing for the minimum fuel consumption rate is practically used as the pressure rise by combustion for this timing is not rapid.

The combustion velocity in main combustion chamber is almost constant, because the fuel flows into the main chamber in an activated state, cracked in the pre-combustion chamber and the unburnt fuel is well distributed by the gas injected from the pre-combustion chamber so that the combustion would easily be advanced even if the timing of injection is retarded.

Consequently, the fuel consumption rate should not change very

much for any timing of fuel injection and an engine with pre-combustion chamber is also comparatively insensitive to the kinds of fuel.

(iii) The pressure difference between the two chambers during the period of combustion becomes large when the timing of fuel injection is quite advanced, so far as the sectional area of the connecting passage is large enough as is usually employed. However, the pressure difference is unexpectedly small when the timing of injection is selected at the point for the minimum fuel consumption rate or at a point later than that, and it is almost the same or smaller than the maximum value of the pressure difference during the compression stroke. Consequently, in the case of an engine with a flat type main combustion chamber, the distribution of fuel in air is not perfect and the magnitude of pressure difference exerts some influence on the combustion rate in the main chamber.

(iv) Even though an engine with pre-combustion chamber is said to be comparatively insensitive to the kinds of fuel, some difference in the performances was noticed in a flat type of main combustion chamber as the cetane value of fuel was changed.

Concerning the effects of cetane value, the fuel consumption rate was best for a fuel of 50~55 cetane value and it became worse in both cases of higher and lower cetane values. This fact seems to result because a group of combustion devices such as the sectional area of connecting passage, the shape and the volume of pre-combustion chamber and the fuel injection system, etc. were determined by the use of usual commercial light oil for many years. In the case of high cetane value fuels, the pressure difference between the chambers during the combustion period is small and the combustion velocity in main chamber becomes a little slower because of an imperfect distribution of fuel. When the cetane value is low, on the other hand, the pressure difference becomes large and the combustion velocity becomes high, but the cooling loss increases because of a severe flow of gas at the initial stage of combustion and the fuel consumption rate increases.

(v) With regard to the difference of using a pintle valve or a throttle valve the rate of pressure rise and the maximum pressure were both low in the pre-combustion chamber as well as in the main chamber and the knocking was small as was expected, when a throttle valve was used. This resulted because the pressure in both chambers

easily balances and the pressure difference between the chambers is small, when the sectional area of connecting passage has a usual dimension of 0.4~0.45% of the piston area.

Since the degree of pressure rise at the initial stage of combustion is closely related to the thermal efficiency of an engine with pre-combustion chamber of large cooling loss, the use of a pintle valve which is accompanied by a rapid pressure rise is required in order to retard the timing of fuel injection and the end of fuel injection must be late so that the whole period of combustion will be retarded. Therefore, the use of a pintle valve also gave the worse result in fuel consumption rate.

In view of these considerations, a throttle valve must be recommended for the purpose of giving the ignition in the middle way of throttling of a throttle valve so that the rate of pressure rise at the initial stage of combustion will be reduced, for the sake of controlling the knocking and the fuel consumption rate.

Furthermore, one can also summarize the following characteristics of combustion in a Diesel engine with pre-combustion chamber from the above discussion:

(a) Since the fuel flows into the main chamber after being activated in the pre-combustion chamber, the combustion in main chamber does not depend upon any slight difference of pressure and temperature in the combustion chamber.

(b) The injection of combustion gas from the pre-combustion chamber is very effective for the distribution of unburnt fuel in the main chamber, and it is also helpful to promote earlier completion of combustion.

The characteristics of combustion in (a) and (b) are the main reasons of the insensitiveness of an engine with pre-combustion chamber in respect to the timing of fuel injection and kinds of fuel.

(c) Since the percentage of cooling loss is comparatively large in an engine with pre-combustion chamber, it is better to make the reduction of the rate of pressure rise at the initial stage of combustion for the purpose of decreasing the fuel consumption rate, too.

(d) As the amount of fuel to be burnt at the initial stage of combustion is small in order to restrict the rate of pressure rise and the maximum pressure, the most part of combustion occurs in the later stage of combustion after reaching the maximum pressure. Even if the combustion progress in this later stage is generally good owing

to the characteristics explained in (a) and (b) without regard to the timing of fuel injection and the kinds of fuel, even a small change of pressure difference between the two chambers also influences the combustion velocity, because the usual sectional area of connecting passage gives originally a small pressure difference and the distribution of fuel into air is also imperfect.

The characteristics for combustion described above may permit to derive the following suggestions for the design of combustion chambers:

(a) So far as one of the characteristics of combustion in an engine with pre-combustion chamber exists in the facts that the fuel is activated by passing through the pre-combustion chamber and the combustion in main chamber occurs quite rapidly, the large throttling loss and cooling loss which are the weak points of an engine with pre-combustion chamber may be able to be reduced by enlarging the sectional area of the connecting passage. The reduction of pressure difference between the two chambers by enlarging the sectional area of connecting passage can be faced by constructing a compact main combustion chamber around the passage.

(b) When the cetane value of fuel is largely changed, attention must be paid in designing the combustion chambers. When the fuel is of a low cetane value, the sectional area of the connecting passage must be enlarged, so that a large cooling loss can be avoided as far as possible by reducing the initial injecting velocity of combustion gas from the pre-combustion chamber.

In the case of a fuel of high cetane value, the main combustion chamber must be constructed compactly around the connection passage, because the pressure difference between the chambers becomes small and the distribution of fuel in the main chamber becomes naturally worse. The devices of shortening the period of fuel injection and enlarging the rate of injection will also be a recommendable method for mastering of the problem of increasing the pressure difference between the combustion chambers.

Closures

A treatment of combustion problems in an actual Diesel engine was undertaken in the present paper based upon the analysis of indicator diagrams. Such analysis includes a tedious procedure of computation but stands on a simple principle. Some actual problems on combustion and performance which are unable to be solved by a fundamental study were clarified. The computation of combustion progress obtainable from indicator diagrams can be performed in comparatively short time when a well prepared calculation plan is established. This kind of procedure may be one of the most effective devices in investigation the combustion problems and judging the performances of an actual engine in the manufacturing factories. The most important thing in applying this method is to have as reliable indicator diagrams as possible. The possibility of obtaining valuable information is wholly dependent on the accuracy of indicator diagrams. The author before concluding this paper would like to stress the vital necessity of the improvements of the indicator for the further development of the studies in this field.