



# HOKKAIDO UNIVERSITY

Title	TAXONOMIC STUDY ON LARVAE AND JUVENILES OF AGONID FISHES IN JAPAN
Author(s)	Maeda, Keiji; Amaoka, Kunio
Citation	MEMOIRS OF THE FACULTY OF FISHERIES HOKKAIDO UNIVERSITY, 35(1), 47-124
Issue Date	1988-03
Doc URL	<a href="https://hdl.handle.net/2115/21883">https://hdl.handle.net/2115/21883</a>
Type	departmental bulletin paper
File Information	35(1)_P47-124.pdf



TAXONOMIC STUDY ON LARVAE AND JUVENILES  
OF AGONID FISHES IN JAPAN

By

Keiji MAEDA and Kunio AMAOKA

*Laboratory of Marine Zoology, Faculty of Fisheries,  
Hokkaido University, Hakodate, Hokkaido 041, Japan*

Contents

	Page
I. Introduction .....	47
II. Acknowledgments .....	48
III. Materials and methods .....	48
IV. Descriptions .....	58
Percidinae	
<i>Percis japonicus</i> .....	58
<i>Hypsagonus</i> sp. ....	60
<i>Agonomalus proboscidalis</i> .....	62
<i>Agonomalus jordani</i> .....	65
Tilesininae and Brachyopsinae	
<i>Tilesina gibbosa</i> .....	71
<i>Ocella dodecaedron</i> .....	73
<i>Ocella</i> sp. ....	76
<i>Brachyopsis rostratus</i> .....	77
<i>Pallasina</i> sp. ....	80
Agoninae	
<i>Podothecus sachi</i> .....	86
<i>Podothecus gilberti</i> .....	90
<i>Podothecus thompsoni</i> .....	95
<i>Podothecus</i> sp. ....	98
<i>Sarritor leptorhynchus</i> .....	100
<i>Bothragonus occidentalis</i> .....	104
Aspidophoroidinae	
<i>Aspidophoroides bartoni</i> .....	112
<i>Anoplagonus occidentalis</i> .....	117
V. Discussion .....	120
VI. Summary .....	122
VII. Literature cited .....	123

I. Introduction

Fishes of the family Agonidae are common bottom fishes of the North Pacific Ocean and the Bering Sea, although very few agonids are distributed in other waters; three species occur in the North Atlantic Ocean and only one species occurs

off South America in the Southern Hemisphere (Freeman, 1951). Nelson (1984) recognized approximately 20 genera and 50 species in this family. Agonids are characterized by a body completely covered with rows of bony plates modified from scales, pelvic fins reduced to one spine and two soft rays, absence of anal fin spines and absence of branched rays in all fins (Freeman, 1951; Hart, 1973).

The larvae and juveniles of the Agonidae have not been sufficiently studied, although adults of this family have been studied taxonomically by a number of the investigators (Jordan and Evermann, 1898; Jordan and Starks, 1904; Freeman, 1951; Matsubara, 1955; Miller and Lea, 1972; Kanayama, 1984; Leipertz, 1985). The larvae and juveniles of this family have been reported by several researchers, since M'Intosh and Prince (1890) first described the larvae of *Agonus cataphractus*. Ehrenbaum (1905) described and illustrated the larvae of *Agonus cataphractus* and *A. decagonus*. The larval stages of *Aspidophoroides obriki* and *A. monopterygius*, were described by Dunbar (1947) and by Bigelow and Schroeder (1953). Marliave (1978) reported on the yolk-sac larvae of *Agonomalus mozinoi* hatched in the aquarium. Recently Washington *et al.* (1984) summarized information on the early life histories of agonids and provided original illustrations for three species, *Hypsagonus quadricornis*, *Stellerina xyosterna* and *Ocella verrucosa*. To date, the early life history stages are known for only 13 species in the world. We describe and illustrate the early life history stages of 17 species collected from the waters around Japan, give useful characters for their identification, and discuss the validity of subfamilies based on larval characters.

## II. Acknowledgments

We wish to express sincere gratitude to Dr. H. Geoffrey Moser of National Marine Fisheries Service, Southwest Fisheries Center for his critical reading of the manuscript. Also, we wish to thank associate professor Kazuhiro Nakaya of the Hokkaido University for useful advice and to thank Dr. Mamoru Yabe, Mr. Tsutomu Kanayama and Dr. Dannie A. Hensley for their helpful suggestions.

We are deeply indebted to the following persons for the loan or gift of valuable materials: Mr. Shin-ichi Kanamaru of the Hokkaido Regional Fisheries Research Laboratory, Mr. Shuka Maruyama of the Hokkaido Fisheries Experimental Station at Wakkanai, Mr. Shoi Kohno of the Nemuro Regional Fisheries Technical Extension Station of Hokkaido Prefecture.

Finally, we dedicate special thanks to the late Dr. Takao Igarashi, the former professor of Hokkaido University, for his encouragement.

## III. Materials and methods

Most specimens used in this study were collected by the Hokkaido Regional Fisheries Research Laboratory on biological research cruises off northern Japan in 1984 and 1985. Other specimens were obtained from a variety of sources. Information on localities, methods and dates of collection are given in Tables 1, 2 and Fig. 1.

In this study, classification of Agonidae follows Jordan and Starks (1904).

Larvae were identified by tracing characters backward from large specimens identified on the basis of meristic characters. We referred to Kanayama (1984) for most information on the meristic characters of adults.

Definition of the boundary between larval and juvenile periods was various and ambiguous in previous works. Recently, Ahlstrom *et al.* (1976) defined the larval period explicitly as the interval from hatching to attainment of complete fin ray counts and initial development of scales. In this study, however, the larval period is defined as the interval from hatching to the entire disappearance of the median finfold, because bony plates (scales) appear before the beginning of notochord flexion in most agonids. The larval period is separated into three phases, *i.e.* preflexion, flexion and postflexion phases, according to Ahlstrom *et al.* (1976).

Terminology of bony plates mostly follows Gruchy (1969) (Fig. 2). The exact separation of MDR from DLR (or MVR from VLR) is impossible, because MDR (or MVR) are single rows of bony plates in adults (Fig. 3A) but double rows in larvae and early juveniles (Fig. 3B). Consequently, we count these bony plates altogether

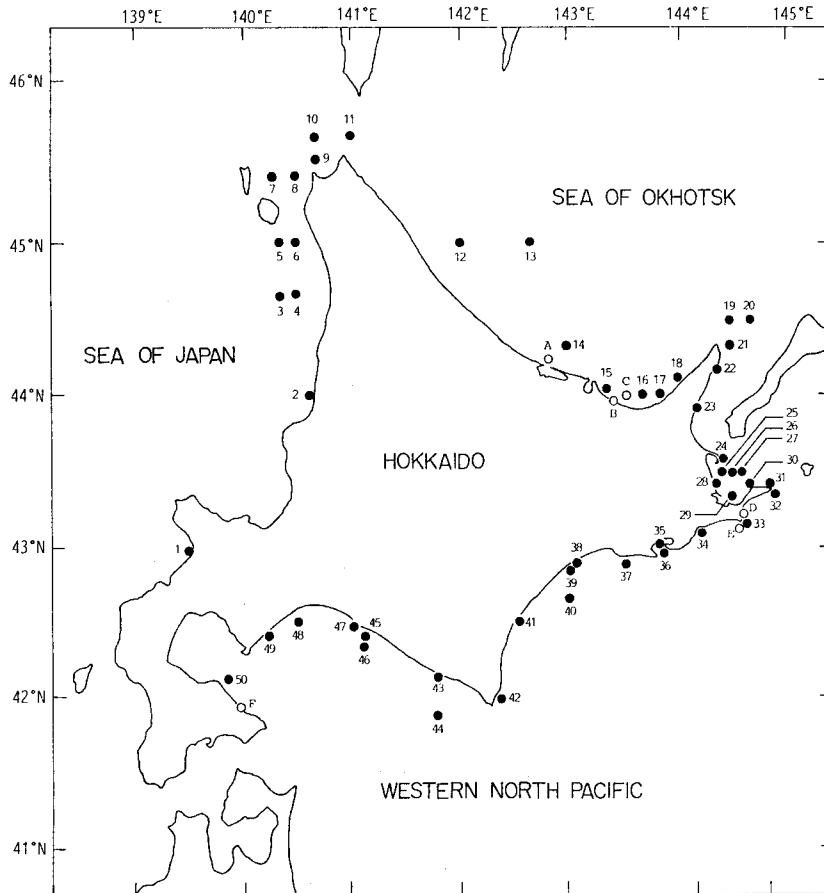

Fig. 1. Map showing sampling stations of the present study.

Table 1. Localities of sampling stations.

Station Code	Latitude North	Longitude East	Station Code	Latitude North	Longitude East
1	42°59.5'	140°30'	29	43°20'	145°30'
2	44°00'	141°38'	30	43°25'	145°40'
3	44°40'	141°20'	31	43°24.6'	145°49.5'
4	44°40'	141°30'	32	43°21.2'	145°51.2'
5	45°00'	141°20'	33	43°10'	145°35'
6	45°00'	141°30'	34	43°06.5'	145°10.5'
7	45°36'	141°28'	35	43°00'-01.2'	144°48.8'-49.5'
8	45°20'	141°30'	36	43°57'-57.4'	144°50.5'-51'
9	45°30'	141°10'	37	42°53'	144°30'
10	45°40'	141°40'	38	42°55'	144°06'
11	45°40'	142°00'	39	42°50'	144°00'
12	45°00'	143°00'	40	42°40'	144°00'
13	45°00'	143°40'	41	42°30'	143°30'
14	44°20'	144°00'	42	42°00'	143°20'
15	44°02'	144°18'	43	42°08.8'	142°45.3'
16	44°00'	144°40'	44	41°52.6'	143°15'
17	44°00'	144°50'	45	42°25.5'	142°06.6'
18	44°06'	145°00'	46	42°21.2'	142°03'
19	44°30'	145°30'	47	42°27'	142°00'
20	44°30'	145°37'	48	42°30'	141°51.3'
21	44°20'	145°30'	49	42°26.2'	141°12.7'-12.8'
22	44°10'	145°20.4'	50	42°09.2'	140°49.5'
23	43°55.5'	145°09'	A	Off Lake Saroma, Hokkaido, Okhotsk Sea.	
24	43°36.9'	145°24.6'	B	Masuura, Hokkaido, Okhotsk Sea.	
25	43°30'	145°25'	C	Off Shibetsu, Hokkaido, Okhotsk Sea.	
26	43°30'	145°30'	D	Ochiishi, Hokkaido, Pacific Ocean.	
27	43°30'	145°35'	E	Off Cape Ochiishi, Hokkaido, Pacific Ocean.	
28	43°25'	145°20'	F	Usujiri, Hokkaido, Pacific Ocean.	

Table 2. Sampling data of specimens. L.N. : Larval Net; N.L. : Night Lamp; B.T. : Beam-trawl; UK. : Unknown.

Specimen Number	Station Code	Date	Method	Net Diam. (cm)
101	22	May 17, 1985	L.N.	250
201	12	Jun. 19, 1985	L.N.	UK.
202	11	Jun. 03, 1984	L.N.	250
203	11	Jun. 03, 1984	L.N.	250
204	11	Jun. 03, 1984	L.N.	250
205	11	Jun. 03, 1984	L.N.	250
206	42	Jun. 03, 1984	L.N.	250
207	11	Jun. 03, 1984	L.N.	250
208	11	Jun. 03, 1984	L.N.	250
209	11	Jun. 03, 1984	L.N.	250
210	11	Jun. 03, 1984	L.N.	250
211	11	Jun. 03, 1984	L.N.	250
212	11	Jun. 03, 1984	L.N.	250
213	11	Jun. 03, 1984	L.N.	250
214	11	Jun. 03, 1984	L.N.	250
301	49	May 14, 1984	L.N.	130
302	49	May 14, 1984	L.N.	130
303	32	May 30, 1984	L.N.	130
304	25	May 30, 1984	L.N.	130
305	34	May 29, 1984	L.N.	130
306	26	May 30, 1984	L.N.	130
307	35	May 29, 1984	L.N.	130
308	31	Jun. 03, 1985	L.N.	UK.
309	24	Jun. 24, 1984	L.N.	250
310	F	May 20, 1985	N.L.	—
311	43	Jun. 14, 1984	L.N.	250
312	45	Jun. 14, 1984	L.N.	250
401	A	May 10, 1979	B.T.	—
501	35	May 29, 1984	L.N.	130
502	36	Apr. 29, 1984	L.N.	250
503	36	Apr. 29, 1984	L.N.	250
504	27	May 30, 1984	L.N.	130
505	46	May 10, 1985	L.N.	UK.
506	26	May 15, 1985	L.N.	UK.
507	29	May 30, 1984	L.N.	130
508	30	May 30, 1984	L.N.	130
509	F	May 16, 1982	N.L.	—
510	43	Jun. 14, 1984	L.N.	250
511	F	May 21, 1983	N.L.	—
512	25	May 15, 1985	L.N.	250
513	25	May 15, 1985	L.N.	130
514	25	May 15, 1985	L.N.	130
601	35	Jun. 25, 1984	L.N.	130
602	35	Jun. 25, 1984	L.N.	130
603	B	Jun. 24, 1980	B.T.	—
604	B	Jul. 11, 1980	B.T.	—
605	B	Jul. 11, 1980	B.T.	—
606	B	Jul. 11, 1980	B.T.	—

Table 2. (Continued)

Specimen Number	Station Code	Date	Method	Net Diam. (cm)
607	B	Jul. 11, 1980	B.T.	—
608	B	Jul. 11, 1980	B.T.	—
701	35	Jun. 25, 1984	L.N.	130
801	43	May 13, 1984	L.N.	250
802	43	May 13, 1984	L.N.	250
803	F	Apr. 25, 1982	N.L.	250
804	41	May 25, 1984	L.N.	250
805	F	Apr. 26, 1984	N.L.	130
806	41	May 25, 1984	L.N.	130
807	F	May 25, 1984	N.L.	—
808	F	Apr. 25, 1982	N.L.	—
809	F	May 07, 1982	N.L.	—
810	F	May 01, 1982	N.L.	—
811	F	May 25, 1979	N.L.	—
812	F	May 14, 1980	N.L.	—
813	F	May 19, 1983	N.L.	—
901	35	Apr. 29, 1984	L.N.	130
902	34	May 29, 1984	L.N.	130
903	31	Jun. 02, 1985	L.N.	UK.
904	38	May 25, 1984	L.N.	130
905	F	May 01, 1982	N.L.	—
906	34	May 29, 1984	L.N.	250
907	35	May 28, 1984	N.L.	—
908	34	May 29, 1984	L.N.	250
909	F	May 14, 1980	N.L.	—
910	F	May 21, 1983	N.L.	—
911	F	May 21, 1983	N.L.	—
1001	4	Apr. 25, 1984	L.N.	130
1002	45	May 13, 1984	L.N.	130
1003	49	May 14, 1984	L.N.	250
1004	15	May 18, 1985	L.N.	UK.
1005	49	May 14, 1984	L.N.	250
1006	1	Apr. 23, 1984	L.N.	250
1007	2	Apr. 23, 1984	L.N.	250
1008	49	May 14, 1984	L.N.	130
1009	8	Apr. 25, 1984	L.N.	250
1010	4	Apr. 25, 1984	L.N.	130
1011	15	May 18, 1985	L.N.	UK.
1012	23	May 30, 1984	L.N.	130
1013	1	Apr. 23, 1984	L.N.	250
1014	4	Apr. 24, 1984	L.N.	250
1015	50	May 15, 1984	L.N.	250
1016	15	May 18, 1985	L.N.	UK.
1017	23	May 30, 1984	L.N.	130
1018	15	May 18, 1985	L.N.	UK.
1019	18	May 17, 1985	L.N.	UK.
1020	18	May 17, 1985	L.N.	UK.
1021	16	May 18, 1985	L.N.	UK.

Table 2. (Continued)

Specimen Number	Station Code	Date	Method	Net Diam. (cm)
1022	39	Jun. 22, 1985	L.N.	UK.
1023	46	Jun. 14, 1984	L.N.	250
1024	48	Jun. 14, 1984	L.N.	250
1025	23	May 30, 1984	L.N.	130
1026	C	Jun. 26, 1979	B.T.	—
1027	9	Jun. 03, 1984	L.N.	250
1028	48	Jun. 14, 1984	L.N.	250
1029	9	Jun. 03, 1984	L.N.	250
1030	49	Jun. 14, 1984	L.N.	250
1031	6	Jun. 03, 1984	L.N.	130
1032	2	Apr. 23, 1984	L.N.	250
1101	38	May 25, 1984	L.N.	130
1102	43	May 10, 1984	L.N.	130
1103	38	May 25, 1984	L.N.	130
1104	43	May 13, 1984	L.N.	250
1105	23	May 30, 1984	L.N.	130
1106	E	Jun. 10, 1984	L.N.	UK.
1107	40	Jun. 22, 1985	L.N.	UK.
1108	39	Jun. 22, 1985	L.N.	UK.
1109	48	Jun. 14, 1984	L.N.	250
1110	39	Jun. 22, 1985	L.N.	UK.
1111	48	Jun. 14, 1984	L.N.	250
1112	46	Jun. 14, 1984	L.N.	250
1113	39	Jun. 22, 1985	L.N.	UK.
1114	48	Jun. 14, 1984	L.N.	250
1115	49	Jun. 14, 1984	L.N.	250
1116	40	Jun. 22, 1985	L.N.	UK.
1201	23	May 30, 1984	L.N.	130
1202	15	May 18, 1985	L.N.	UK.
1203	15	May 18, 1985	L.N.	UK.
1204	15	May 18, 1985	L.N.	UK.
1205	15	May 18, 1985	L.N.	UK.
1206	15	May 18, 1985	L.N.	UK.
1207	5	May 23, 1985	L.N.	UK.
1208	39	Jun. 22, 1985	L.N.	UK.
1301	22	May 17, 1985	L.N.	250
1302	11	Jun. 06, 1984	L.N.	250
1303	11	Jun. 06, 1984	L.N.	250
1304	11	Jun. 06, 1984	L.N.	250
1305	20	May 17, 1985	L.N.	UK.
1306	11	Jun. 05, 1984	L.N.	250
1307	23	May 30, 1984	L.N.	130
1308	19	May 31, 1984	L.N.	250
1309	11	Jun. 06, 1984	L.N.	250
1310	11	Jun. 05, 1984	L.N.	250
1311	11	Jun. 06, 1984	L.N.	250
1312	11	Jun. 06, 1984	L.N.	250
1313	11	Jun. 05, 1984	L.N.	250
1314	11	Jun. 05, 1984	L.N.	250
1315	11	Jun. 06, 1984	L.N.	250

Table 2. (Continued)

Specimen Number	Station Code	Date	Method	Net Diam. (cm)
1316	11	Jun. 05, 1984	L.N.	250
1317	17	Jun. 07, 1984	L.N.	130
1401	35	Apr. 29, 1984	L.N.	130
1402	35	Apr. 29, 1984	L.N.	130
1403	32	May 30, 1984	L.N.	250
1404	33	May 30, 1984	L.N.	130
1405	13	May 18, 1985	L.N.	UK.
1406	42	May 11, 1985	L.N.	130
1407	22	May 17, 1985	L.N.	250
1408	33	May 30, 1984	L.N.	130
1409	21	May 17, 1985	L.N.	UK.
1410	3	May 23, 1985	L.N.	UK.
1411	11	Jun. 06, 1984	L.N.	250
1412	11	Jun. 06, 1984	L.N.	250
1413	11	Jun. 06, 1984	L.N.	250
1414	7	May 22, 1985	L.N.	UK.
1415	11	Jun. 06, 1984	L.N.	250
1416	10	May 20, 1985	L.N.	UK.
1417	11	Jun. 06, 1984	L.N.	250
1418	41	Jun. 22, 1985	L.N.	250
1419	11	Jun. 06, 1984	L.N.	250
1420	7	May 22, 1985	L.N.	UK.
1421	42	May 11, 1985	L.N.	250
1501	F	Apr. 12, 1985	N.L.	—
1502	F	Apr. 26, 1984	N.L.	—
1503	F	Apr. 26, 1984	N.L.	—
1504	F	Apr. 12, 1985	N.L.	—
1505	F	May 09, 1984	N.L.	—
1506	F	May 24, 1985	N.L.	—
1507	F	May 19, 1983	N.L.	—
1508	34	May 29, 1985	L.N.	130
1509	F	May 19, 1983	N.L.	—
1510	F	May 17, 1984	N.L.	—
1511	D	Jun. 18, 1984	L.L.	—
1512	F	May 08, 1979	N.L.	—
1513	F	May 25, 1979	N.L.	—
1514	F	Aug. 09, 1984	N.L.	—
1515	F	Aug. 09, 1984	N.L.	—
1601	36	May 28, 1984	L.N.	130
1602	36	May 28, 1984	L.N.	130
1603	36	May 28, 1984	L.N.	130
1604	37	May 28, 1984	L.N.	130
1605	E	Jun. 25, 1985	L.L.	UK.
1606	14	May 18, 1985	L.N.	UK.
1607	17	Jun. 07, 1984	L.N.	250
1608	39	Jun. 22, 1985	L.N.	UK.
1609	39	Jun. 22, 1985	L.N.	UK.
1610	49	Jun. 14, 1984	L.N.	250
1701	23	May 30, 1984	L.N.	130

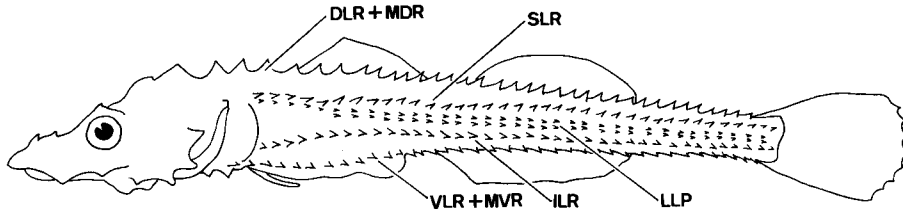

Fig. 2. Terminology of bony plates in agonid larvae: DLR, dorsolateral plates; MDR, mid-dorsal plates; SLR, supralateral plates; ILR, infralateral plates; VLR, ventrolateral plates; MVR, mid-ventral plates; LLP, lateral line plates.

Fig. 3. Comparison of DLR and MDR between adult condition and larval condition. A, adult condition; B, larval condition.

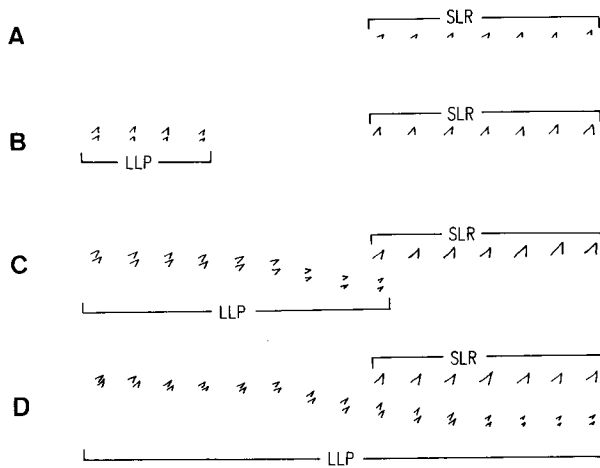
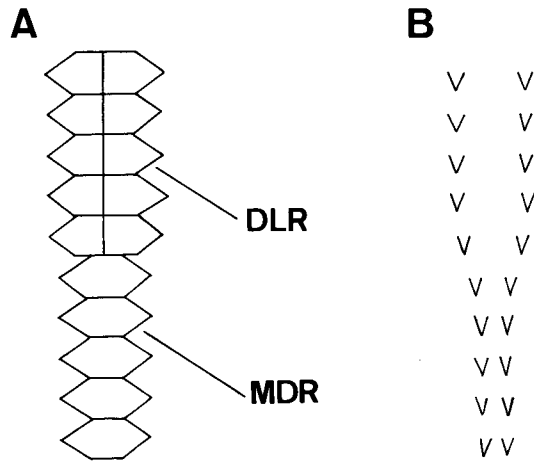

Fig. 4. Process of formation in LLP. Pattern I.

in a total number as DLR+MDR (VLR+MVR).

LLP must be defined in relation to the following three formation patterns, since the row is formed peculiarly.

Formation pattern I: (1) In the early larval period, SLR is formed (Fig. 4A). (2) In the late larval period, a double row of bony plates extends backward from the anterior bony plates (Fig. 4B-D). In this formation pattern, LLP is defined as the double row extending backward from the region above the pectoral fin.

Formation pattern II: (1) In the early larval period, a single row of bony plates extends forward in the early larval period (Fig. 5A-C). (2) In the late larval period, a tiny bony plate appears at the base of the each anterior bony plate to form a double row (Fig. 5D). The addition of the tiny bony plates extends backward to a certain point (Fig. 5E). (3) Posterior to this point, a double row of tiny bony plates is formed below the single row (Fig. 5F, G). In this formation pattern, the double row is LLP and the single row is SLR. LLP anterior to the origin of SLR is defined as ALLP (anterior LLP) and LLP posterior to the origin of SLR is defined

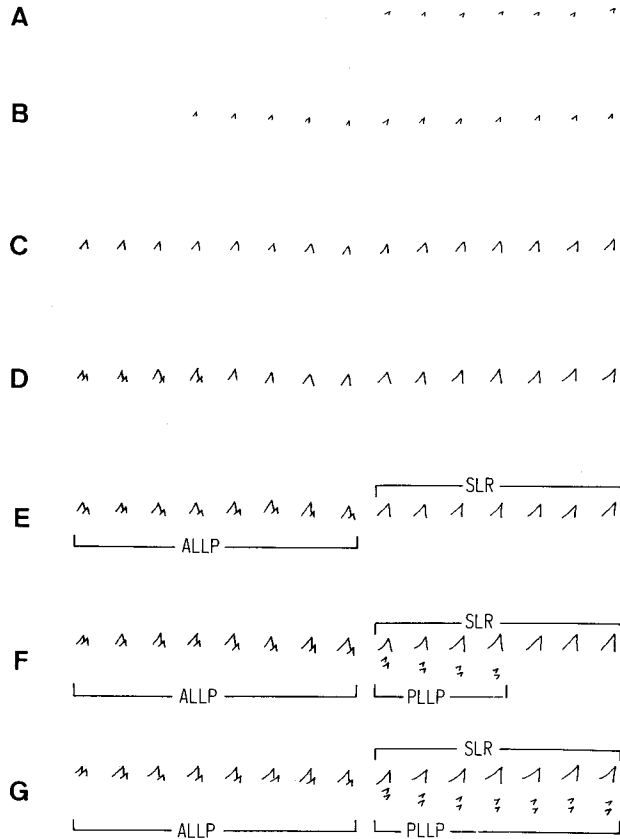

Fig. 5. Process of formation in LLP. Pattern II. ALLP, anterior part of LLP; PLLP, posterior part of LLP.

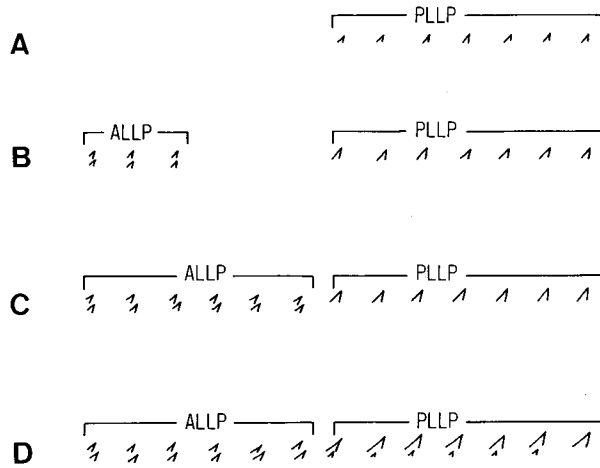

Fig. 6. Process of formation in LLP. Pattern III. ALLP, anterior part of LLP; PLLP, posterior part of LLP.

as PLLP (posterior LLP).

Formation pattern III: (1) In the early larval period, a single row of bony plates is formed from the middle of the trunk to the caudal peduncle (Fig. 6A). (2) In the late larval period, a double row of bony plates is formed anterior to the single row (Fig. 6B, C). (3) A tiny bony plate appears at the base of each plate in the PLLP series to form a double row (Fig. 6D). In this formation pattern, LLP is defined as the entire double row. The single row of bony plates formed in the early larval period (Fig. 6A) and the additional single row of tiny bony plates below it (Fig. 6D) are defined as PLLP altogether, and the double row of bony plates anterior to PLLP is defined as ALLP.

Morphometrics are defined as follows (Fig. 7):

Standard length (SL): Horizontal distance from tip of snout to tip of notochord, before formation of hypural elements, and to posterior margin of hypural elements after formation of hypural elements.

Snout to anus length: Horizontal distance from tip of snout to posterior margin

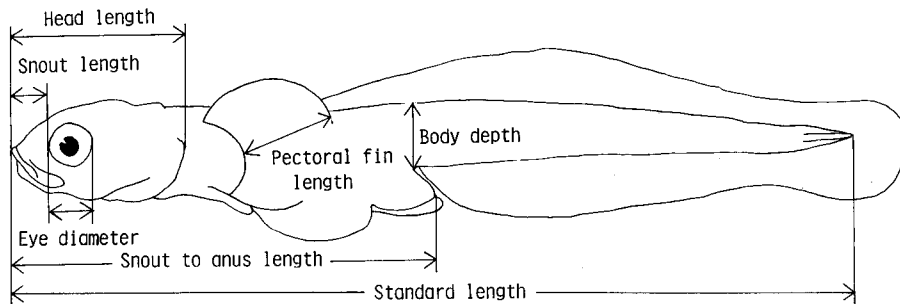

Fig. 7. Terminology of morphometrics.

of anus.

Body depth : Vertical distance through the most constricted point just behind anus.

Head length (HL) : Horizontal distance from tip of snout to posterior margin of gill opening.

Eye diameter : Maximum distance across the center of pigmented area of eye.

Pectoral fin length : Distance from middle part of fin blade to posterior margin of fin blade or length of longest fin ray after fin rays reach posterior margin of the larval fin blade.

#### IV. Descriptions

##### 1. Subfamily Percidinae

##### *Percis japonicus* (Pallas)

Japanese name : Inugochi (Fig. 8, Table 3)

##### 1) Specimen examined

Number of specimen, length of specimen and its developmental stage are shown in Table 3.

##### 2) Morphology

Meristic counts are shown in Table 3.

Body stout, its depth 26.8% of SL ; trunk slightly elevated below origin of first dorsal fin ; snout to anus length 62.3% of SL ; head length 29.7% of SL ; snout length 26.8% of HL ; eye diameter 29.3% of HL ; tip of snout blunt ; profile of abdomen slightly bulged ; gill membranes united and free from isthmus ; jaws about level ; nostril divided into two ; notochord flexing.

Nasal and supraocular spines not present ; fronto-parietal ridge faint and without spine ; three preopercular spines present ; faint hump present on post-temporal region ; no postocular spines anterior to hump ; each branchiostegal ray lacks process near proximal tip (Fig. 30A).

Bony plates of DLR and MDR not yet formed ; bony plates of SLR and ILR not yet formed in anterior and posterior parts, and each row has 31 bony plates respectively ; VLR has 15 bony plates, but plates not present in part anterior to

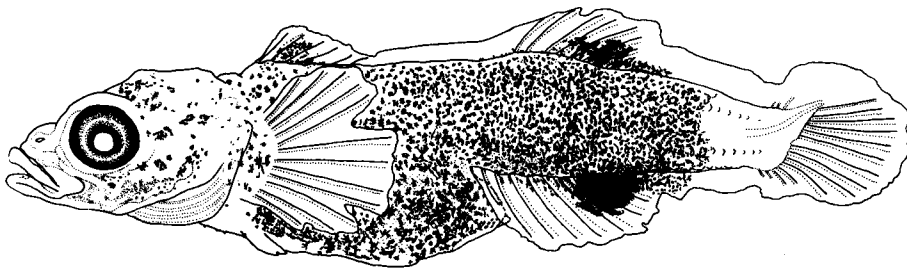

Fig. 8. Larva of *Percis japonicus*. 13.8 mm. Scale indicates 5 mm.

Table 3. Meristic structures in *Percis japonicus*.

Spec. No.	SL (mm)	Developmental stage	Dorsal fin		Anal fin rays	Pectoral fin rays	Pelvic fin rays	Bony plates				
			spines	rays				DLR+MDR	SLR	ILR	VLR+MVR	LLP
101	13.8	Flexion	6	7	8	12	Buds	0	31	31	15	0

Table 4. Development of meristic structures in *Hypsagonus* sp.

Spec. No.	SL (mm)	Developmental stage	Dorsal fin		Anal fin rays	Pectoral fin rays	Pelvic fin rays	Bony plates				
			spines	rays				DLR+MDR	SLR	ILR	VLR+MVR	LLP
201	11.1	Flexion	9	6	9	13	3	0	23	26	0	2
202	12.1	Postflexion	9	6	10	12	I, 2	36	24	28	33	2
203	12.3	Postflexion	8	6	10	13	I, 2	34	25	29	34	2
204	12.6	Postflexion	10	7	10	13	I, 2	36	27	29	35	5
205	12.7	Postflexion	9	6	10	13	I, 2	35	28	29	33	7
206	12.7	Postflexion	7	6	10	12	I, 2	32	27	30	31	4
207	12.8	Postflexion	9	7	10	13	I, 2	34	25	29	33	3
208	13.0	Postflexion	8	7	10	12	I, 2	38	27	30	35	7
209	13.1	Postflexion	9	7	10	12	I, 2	34	26	29	33	5
210	13.6	Postflexion	9	7	10	13	I, 2	36	27	29	34	5
211	13.8	Postflexion	9	6	9	13	I, 2	38	27	30	32	7
212	14.0	Postflexion	9	6	10	13	I, 2	37	26	29	33	7
213	14.0	Postflexion	9	7	10	13	I, 2	38	25	31	34	8
214	14.8	Postflexion	8	7	10	13	I, 2	38	29	32	32	8

seventh anal fin ray; no bony plates on ventral surface of abdomen.

Full complements of all fins formed except for pelvic fin; first dorsal fin starts just behind nape and ends somewhat anterior to level of posterior end of pectoral fin; second dorsal fin starts at level of third anal fin ray and extends one-third of distance to end of body; anal fin starts just behind anal median finfold and ends at level of end of dorsal fin; median finfolds present between first and second dorsal fins, between second dorsal and caudal fins, and between anal and caudal fins; small preanal finfold present; no barbels on tip of snout.

### 3) Pigmentation

Lateral surface of body heavily pigmented, unpigmented area on dorsolateral hindgut and posterior part of body; latter unpigmented area situated on last three myomeres and hypurals, and bears six bony plates on SLR and ILR respectively; ventral surface of abdomen wholly pigmented (Fig. 30A); fore-, mid- and hindbrain wholly covered with many melanophores; their superficial regions also covered with melanophores; gular region heavily pigmented (Fig. 30A); gill membranes unpigmented.

Dorsal median finfold has two heavily pigmented blotches on anterior half of first dorsal fin and posterior half of second dorsal fin, and blotch on latter expanded at base anteriorly and posteriorly; anal fin has heavily pigmented blotch on posterior part, and blotch expanded at base anteriorly and posteriorly; caudal, pectoral and pelvic fins unpigmented.

## *Hypsagonus* sp.

(Fig. 9, Table 4)

### 1) Specimens examined

Number of specimens, length of specimens and their developmental stages are shown in Table 4.

### 2) Morphology

Meristic counts are shown in Table 4.

Body stout, its depth 13.2% to 15.7% of SL; trunk not elevated at origin of first dorsal fin; snout to anus length decreases proportionally from 58.7% of SL in flexion phase to 51.4-53.4% of SL in late postflexion phase; head length 26.1% to 33.1% of SL; snout length 19.6% to 22.4% of HL; eye diameter decreases proportionally from 34.5% of HL in flexion phase to 24.4-31.4% of HL in postflexion phase; profile of abdomen slightly bulged in flexion phase, gradually flattens during postflexion phase; gill membranes united and free from isthmus; upper jaw slightly protruded beyond lower jaw; nostril separates into two at 12.1 mm; notochord flexing in smallest specimen examined (11.1 mm SL); notochord flexion completes at 12.1 mm.

Smallest specimen already has faint nasal spine; supraocular ridge with spine appears at 12.1 mm; dull projection present on parietal region in smallest specimen examined; another dull projection appears on frontal region at 12.1 mm, and connected with projection on parietal region to form deeply concave fronto-parietal ridge; three preopercular spines present in smallest specimen examined and four

preopercular spines complete at 12.1 mm; hump on posttemporal region and two pairs of postocular spines appear at 12.1 mm; each pair of postocular spines fuses at 12.3 mm; posttemporal hump and postocular spines fuse to form ridge with canal during postflexion phase; each branchiostegal ray lacks process near proximal tip (Fig. 30B).

Full complements of bony plates formed in DLR, MDR, SLR, ILR, VLR and MVR at 12.1 mm and in LLP at 12.7-13.8 mm; LLP extends backward as double row; first and second LLP large and strong; bony plates in all rows except for LLP formed initially as humped projections, then gradually become spiny.

Full complements of all fins already acquired in smallest specimen examined; median finfold gradually degenerates, but persists in largest specimen examined; preanal finfold disappears at 12.3 mm; first dorsal fin starts over first to third DLR and ends over ninth to middle of 12th-13th; second dorsal fin starts over 17th to middle of 21st-22nd DLR and ends over 24th to 28th; anal fin starts under 13th to 15th VLR and ends under middle of 21st-22nd to 24th-25th; lower pectoral fin rays free from membrane in postflexion phase; pectoral fin length 18.0% of SL (11.1 mm SL) to 25.4% of SL (13.8 mm SL); posterior end of pectoral fin does not reach level of anus in largest specimen examined; small barbel appears on tip of snout at 12.1 mm, and does not increase markedly in length with development.

### 3) Pigmentation

Lateral surface of body heavily pigmented with narrow unpigmented area on posterior part of hypurals; unpigmented area bears 0-2 bony plates on SLR and 0-1 bony plate on ILR; triangular unpigmented area on ventral surface of abdomen

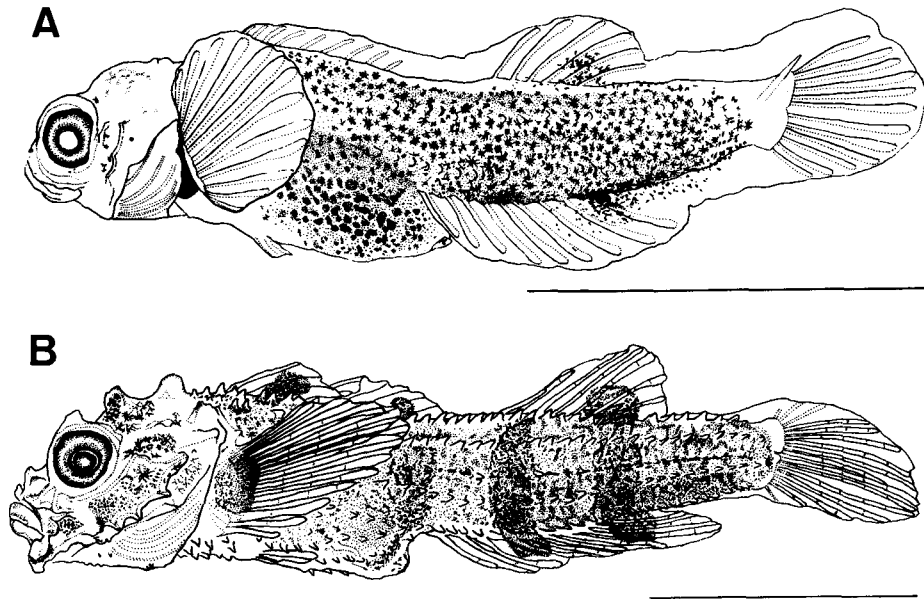

Fig. 9. Larvae of *Hypsagonus* sp. A, 11.1 mm; B, 14.0 mm. Each scale indicates 5 mm.

(Fig. 30B); fore-, mid- and hindbrain wholly covered with many melanophores; their superficial regions also covered with melanophores; gular region unpigmented or faintly pigmented (Fig. 30B); a few melanophores present on gill membranes basally between 4th-6th branchiostegal rays, but not arranged regularly along branchiostegal rays.

Smallest specimen examined has heavily pigmented blotch on anterior parts of first dorsal fin and on posterior parts of second dorsal and anal fins; additional heavily pigmented blotch appears on posterior part of first dorsal fin and on anterior parts of second dorsal and anal fins respectively during postflexion phase; caudal fin unpigmented throughout development; pectoral fin unpigmented in flexion and early postflexion phases; large blotch appears on base of pectoral fin in specimens more than 13.6 mm; pelvic fin unpigmented.

***Agonomalus proboscidalis* (Valenciennes)**

Japanese name: Atsumori-uo (Fig. 10, Table 5)

1) Specimens examined

Number of specimens, length of specimens and their developmental stages are shown in Table 5.

2) Morphology

Meristic counts are shown in Table 5.

Body stout, its depth increases slightly from 9.1-10.1% of SL in preflexion phase to 12.3-15.4% of SL in postflexion phase; trunk not elevated below origin of first dorsal fin in preflexion phase, but gradually becomes highly elevated during postflexion phase and juvenile period; snout to anal length decreases proportionally from 55.0-55.7% of SL in preflexion phase to 48.6% of SL in juvenile period; head length increases from 23.0-25.8% of SL in preflexion phase to 28.1-31.6% of SL in postflexion phase; snout length increases from 11.8-15.0% of HL in preflexion phase to 38.5% of HL in juvenile period; eye diameter decreases proportionally from 57.1% of HL in smallest specimen examined (6.1 mm SL) to 38.5% of HL in largest specimen examined (14.2 mm SL); profile of abdomen slightly constricted into three parts in preflexion phase; and gradually flattens during flexion phase; gill membranes united and free from isthmus; nostril separates into two at 11.2 mm; upper jaw slightly protruded beyond lower jaw; notochord flexion starts at 9.3 mm and completes at 11.2 mm.

A pair of nasal spines appears at 10.2 mm and fuses at 11.2 mm; supraocular ridge appears at 10.2 mm and another spine appears on mesial side of supraocular ridge at 11.2 mm; four preopercular spines present at 10.2 mm; fronto-parietal ridge appears at 10.2 mm; it becomes deeply concave in postflexion phase; a pair of posttemporal spines appears at 9.8 mm and fuses to form hump at 10.2-11.2 mm; another small spine appears at base of posttemporal hump; two postocular spines appear at 11.2 mm; posttemporal hump fuses with postocular spines to form ridge with canal during postflexion phase; each branchiostegal ray lacks process near proximal tip (Fig. 30C).

Full complements of bony plates appear in SLR and ILR at 11.2 mm; LLP not

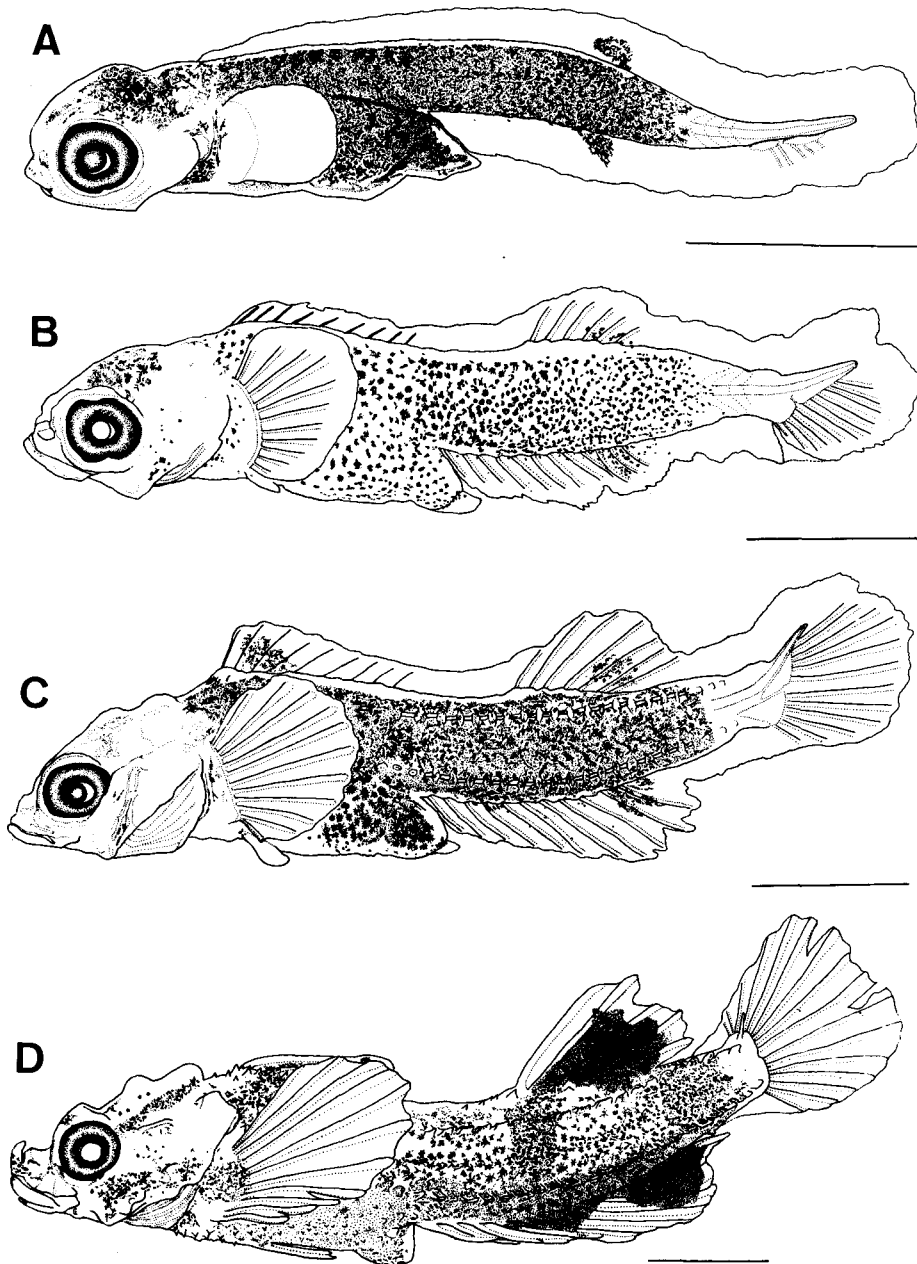

Fig. 10. Larvae of *Agonomalus proboscidalis*. A, 6.1 mm ; B, 9.3 mm ; C, 10.6 mm ; D, 12.4 mm. Each scale indicates 2 mm.

Table 5. Development of meristic structures in *Agonomalus proboscidalis*.

Spec. No.	SL (mm)	Developmental stage	Dorsal fin		Anal fin rays	Pectoral fin rays	Pelvic fin rays	Bony plates				
			spines	rays				DLR+MDR	SLR	ILR	VLR+MVR	LLP
301	6.1	Preflexion	0	0	0	0	Buds	0	0	0	0	0
302	6.6	Preflexion	0	4	7	8, 10*	Buds	0	0	0	0	0
303	7.9	Preflexion	9	6	12	11	Buds	0	12	19	0	0
304	9.3	Flexion	9	6	12	11	Buds	0	15	18	0	0
305	9.8	Flexion	9	7	12	11	Buds	0	22	23	0	0
306	10.2	Flexion	9	7	11	11	Buds	0	23	25	0	0
307	10.6	Flexion	10	7	12	11	Buds	0	23	27	0	0
308	11.2	Postflexion	10	6	12	11	I, 2	16	27	29	5**	0
309	11.7	Postflexion	10	6	12	11	I, 2	16	22	30	4**	5
310	12.2	Postflexion	9	7	12	11	I, 2	15	27	30	5**	0
311	12.4	Postflexion	8	5	11	11	I, 2	18	25	30	6**	19
312	14.2	Juvenile	9	6	12	11	I, 2	25	25	31	6**	22

\* Right side.

\*\* The anterior part of VLR can not be counted, because many small bony plates are scattered on the ventrolateral surface of the abdomen.

Table 6. Meristic structures in *Agonomalus jordani*.

Spec. No.	SL (mm)	Developmental stage	Dorsal fin		Anal fin rays	Pectoral fin rays	Pelvic fin rays	Bony plates				
			spines	rays				DLR+MDR	SLR	ILR	VLR+MVR	LLP
401	13.8	Juvenile	9	8	14	11	I, 2	24	26	29	12	26

completed in largest specimen examined; LLP extends backward as double row; bony plates in DLR uneven in spacing and extend from origin of dorsal fin to middle of second dorsal fin; many small bony plates scattered on ventrolateral surface of abdomen in postflexion phase; all bony plates formed initially as dull projection, then gradually become spiny.

Full complements of all fins appear at 7.9 mm; median finfold gradually degenerates and disappears entirely between first and second dorsal fins at 12.4 mm, between second dorsal and caudal fins at 12.4 mm, and between anal and caudal fins at 14.2 mm; preflexion and flexion larvae have small preanal finfold, which disappears at 11.7 mm; first dorsal fin starts just behind nape and ends at level anterior to origin of anal fin; second dorsal fin starts at middle of tail and ends at level of end of anal fin; anal fin starts just behind anal finfold and extends to two-thirds of body; pectoral fin length increases from 9.5–13.1% of SL in preflexion phase to 19.7–26.5% of SL in postflexion phase; posterior end of pectoral fin reaches level of anus at 11.7–14.2 mm; small barbel appears on tip of snout at 11.2 mm; it increases in length and gradually becomes compressed.

### 3) Pigmentation

Lateral surface of body heavily pigmented with unpigmented area on dorsal margin, dorsolateral surface of hindgut and posterior part of body; last unpigmented area situated on last two or three myomeres and hypurals in preflexion and flexion phases, and bears 0–3 bony plates in SLR and 0–2 bony plates in ILR in postflexion phase; barbel on tip of snout pigmented at basal and middle portions; ventral surface of abdomen wholly pigmented (Fig. 30A); gill membranes unpigmented in preflexion and flexion phases; a few melanophores appear on anterior part of gill membranes in postflexion phase and on posterior and outer part in juvenile period; gular region unpigmented in early preflexion larvae; melanophores appear on gular region at 7.9 mm and increase in number during flexion phase (Fig. 30C).

Smallest specimen already has two heavily pigmented blotches on median finfold; after completion of fins, both blotches situated in posterior parts of second dorsal and anal fins; heavily pigmented blotch appears on anterior part of first dorsal fin at 10.2 mm and on middle of anal fin at 11.2 mm; largest specimen examined has one additional small blotch on anterior part of anal fin; in late postflexion phase, caudal fin becomes pigmented at base; largest specimen examined has large blotch on base of caudal fin and a few small blotches on middle and posterior parts; pectoral fin unpigmented throughout preflexion and flexion phases; it starts to be pigmented basally at 11.7 mm and pigmented area gradually expands to form large blotch; pelvic fin lacks melanophores in preflexion phase and faintly pigmented at base in flexion phase.

### *Agonomalus jordani* Schmidt

Japanese name: Kumagai-uo (Fig. 11, Table 6)

#### 1) Specimen examined

Number of specimen, length of specimen and its developmental stage are shown in Table 6.

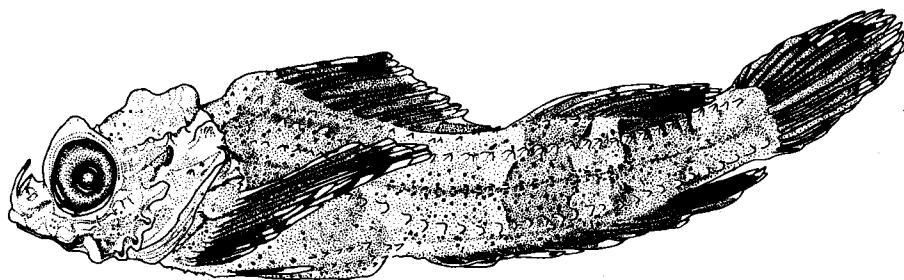

Fig. 11. Juvenile of *Agonomalus jordani*. 13.8 mm. Scale indicates 5 mm.

## 2) Morphology

Meristic counts are shown in Table 6.

Body stout, its depth 16.7% of SL; trunk highly elevated at origin of first dorsal fin; snout to anus length 44.9% of SL; head length 29.0% of SL; snout length 22.5% of HL; tip of snout blunt; eye diameter 29.3% of HL; profile of abdomen flat; gill membranes united and free from isthmus; upper jaw slightly protruded beyond lower jaw; nostril divided into two; notochord flexion completed.

Nasal spine well developed; supraocular ridge highly elevated anteriorly; fronto-parietal ridge somewhat concave at middle; four preopercular spines with ridges present; large hump present on posttemporal region; postocular ridge has three projections; each branchiostegal ray lacks process near proximal tip.

Full complements of bony plates already acquired in all rows except for LLP; number of bony plates 24 in DLR, 26 in SLR, 29 in ILR, 12 in VLR and 26 in LLP; bony plates in DLR uneven in spacing, and extend from origin of first dorsal fin to middle of second dorsal fin; LLP composed of double row; many small bony plates scattered on ventrolateral surface of abdomen.

Full complements of fins already acquired; first dorsal fin starts just behind nape and ends at level slightly posterior to anus; second dorsal fin starts at about middle of body and extends to three-fourths of body; anal fin starts at level somewhat posterior to anus and ends at level slightly anterior to end of dorsal fin; median finfolds lost; long filamentous barbel on tip of snout.

## 3) Pigmentation

Lateral surface of body wholly pigmented with three vertical bands; first situated below first dorsal fin, second and third below second dorsal fin; fore-, mid- and hindbrain wholly covered with many melanophores; their superficial regions also covered with melanophores; gular region heavily pigmented; numerous small melanophores scattered on gill membranes.

First and second dorsal fins and anal fin pigmented wholly except for their margins; caudal and pectoral fins heavily pigmented with a few unpigmented areas posteriorly; pelvic fin pigmented from base to two-thirds of length.

### Summary and comparison of Percidinae

#### 1) Identification

Four percidine developmental series are recognized by pigment patterns and meristic structures (fin rays and bony plates). Each series is recognized as belonging to Percidinae by three characters: (1) gill membranes united and free from isthmus, (2) lower jaw not protruding beyond upper jaw, and (3) first dorsal fin origin at nape (Jordan and Starks, 1904; Matsubara, 1955). Meristic comparison of adults and developmental series (Table 7) also aids in identification.

Diagnostic characters for *Percis japonicus* are six spines on the first dorsal fin and eight rays on the anal fin. The genus *Hypsagonus* is recognized by having lower pectoral fin rays free from the membrane (Matsubara, 1955). In this genus, one species, *Hypsagonus quadricornis* is recorded from Japan. There is, however, a possibility of distribution of another species, *Hypsagonus corniger*, because it is recorded from Peter the Great Bay in the Sea of Japan (Taranetz, 1933). Our series is similar to *H. quadricornis* in having 8-10 spines in the first dorsal fin, but is also similar to *H. corniger* in having 9-10 rays on the anal fin and 29-32 bony plates on ILR. Consequently, our series cannot be identified as *H. quadricornis* or *H. corniger*, and is referred to *Hypsagonus* sp. *Agonomalus proboscidalis* is recognized by having five to seven rays on the second dorsal fin, 11-12 rays on the anal fin and 11 rays on the pectoral fin. *Agonomalus jordani* is identified by having eight rays on the second dorsal fin and 14 rays on the anal fin.

#### 2) Comparison of other useful characters for identification

*Snout to anus length.* — Snout to anus length is proportionally longer in *Percis japonicus* (62.3% of SL in 13.8 mm SL) than in *Hypsagonus* sp. (51.4-55.9% of SL in 13.6-14.2 mm SL), *Agonomalus proboscidalis* (48.6-52.4% of SL in 12.4-14.2 mm SL) and *A. jordani* (44.9% of SL in 13.8 mm SL).

*Notochord flexion.* — Notochord flexion is completed at 11.2 mm in *A. proboscidalis* (Table 5), at 12.1 mm in *Hypsagonus* sp. (Table 4), and is already completed in *Agonomalus jordani* at 13.8 mm. *Percis japonicus* is still undergoing flexion at 13.8 mm.

*Spine on mesial side of end of supraocular ridge.* — The members of *Agonomalus* have a small spine on the mesial side of the posterior end of the supraocular ridge, but *Hypsagonus* sp. and *Percis japonicus* lack the spine.

*Barbel on tip of snout.* — The barbel is lacking in *Percis japonicus*, short in *Hypsagonus* sp., compressed in *Agonomalus proboscidalis* (Fig. 12A) and filamentous in *A. jordani* (Fig. 12B).

*Fronto-parietal ridge.* — At about 14 mm, the fronto-parietal ridge is faint in *Percis japonicus* (Fig. 8), deeply concave in *Hypsagonus* sp. and *Agonomalus proboscidalis* (Figs. 9B and 10D) and slightly concave in *A. jordani* (Fig. 11).

*First and second LLP.* — First and second LLP are large and strong in *Hypsagonus* sp., but are small in *Agonomalus proboscidalis* and *A. jordani*.

*Gular region.* — The gular region is not pigmented or faintly pigmented in *Hypsagonus* sp. (Fig. 30B), but is heavily pigmented in the other three species at about 14 mm (Fig. 30A, C).

Table 7. Comparison of meristic counts between present larvae and juveniles, and adults

	Larvae and juveniles			
	<i>Percis japonicus</i>	<i>Hypsagonus</i> sp.	<i>Agonomalus proboscidalis</i>	<i>Agonomalus jordani</i>
First dorsal spines	6	8-10	8-9	9
Second dorsal rays	7	6-7	5-7	8
Anal fin rays	8	9-10	11-12	14
Pectoral fin rays	12	12-13	11	11
DLR+MDR	0	36-38	12-25	24
SLR	31**	25-29	25-27	26
ILR	31**	29-32	29-31	29
VLR+MVR	15**	32-37	***	12

\* Data from Taranetz (1933).

\*\* Incomplete.

\*\*\* Uncountable.

*Barbel on tip of snout.* — The barbel on the tip of the snout is not pigmented in *Hypsagonus* sp., pigmented only at its base in *Agonomalus proboscidalis* (Fig. 12A) and pigmented only on its tip in *A. jordani* (Fig. 12B).

*Ventral surface of abdomen.* — *Percis japonicus* is pigmented wholly on the ventral surface of the abdomen (Fig. 30A). *Hypsagonus* sp. has a triangular unpigmented area on the ventral surface of the abdomen (Fig. 30B). An unpigmented area is present or absent on the ventral surface of the abdomen in *Agonomalus proboscidalis* (Fig. 30C), but is never triangular if present. *Agonomalus jordani* has an indistinct small unpigmented area around the anus.

*Posterior part of body.* — *Percis japonicus* has a wide unpigmented area on the last three myomeres and hypural area, which bears six bony plates in the SLR and ILR series (Fig. 8). *Hypsagonus* sp. has a narrow unpigmented region on the hypurals, which bears 0-2 bony plates in the SLR series and 0-2 bony plates in the DLR series (Fig. 9B). *Agonomalus proboscidalis* has an unpigmented area on the

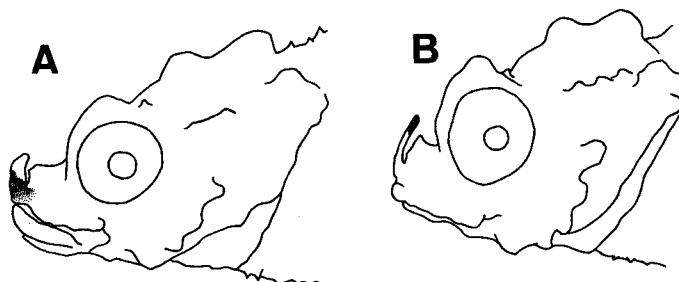

Fig. 12. Comparison of barbel on tip of snout. A, *Agonomalus proboscidalis*; B, *A. jordani*.

of six species of Percinae in Japan. Adult's data are from Kanayama (1984) unless noted.

Adults					
<i>Percis japonicus</i>	<i>Percis matsuii</i>	<i>Hypsagonus quadricornis</i>	<i>Hypsagonus corniger</i>	<i>Agonomalus proboscidalis</i>	<i>Agonomalus jordani</i>
5-6	4-5	8-9	7-8*	9	7-9
6-8	5	5-7	7*	5-7	6-8
7-9	5-6	10-11	9-10*	11-13	13-14
12-13	11	12-14	12*	10-11	10-11
34-41	37-42	25-37	—	0-5	0
36-40	35-39	25-30	26-27*	24-29	22-29
36-40	35-39	25-30	30-31*	24-29	22-29
30-38	27-38	23-35	—	5-19	6-13

last two or three myomeres and hypural area in preflexion and flexion phases and bears 0-3 bony plates in the SLR series and 0-2 bony plates in the ILR series in the late flexion and postflexion phases (Fig. 10C). *Agonomalus jordani* lacks unpigmented area on the posterior part of the body (Fig. 11).

### 3) Comparison with other percine species and other similar species

Marliave (1978) described and illustrated the yolk-sac larvae of the eastern Pacific species, *Agonomalus mozinoi* (5.5, 6.0 mm SL). *Agonomalus proboscidalis* differs from *A. mozinoi* in the pigmentation of the lateral surface of the body and median finfold. In the former species, the lateral surface of the body is heavily pigmented except for the caudal peduncle region (Fig. 10A); in the latter species, the lateral surface of the body is heavily pigmented except for its posterior third. The blotches on the dorsal and anal median finfolds are situated at the middle of the tail in *A. proboscidalis* (Fig. 10A), but are at the anterior half of the tail in *A. mozinoi*.

Before the bony plates are formed, percine agonids are similar to cottid larvae of the *Myoxocephalus* and *Hemitripteris* groups (Washington *et al.*, 1984) in having heavily pigmented bodies except for their posterior ends. Percine agonids differ from the members of their cottid groups in the abdominal pigment pattern. The abdomen is heavily pigmented wholly or lacks pigment only along its midline in Percinae, whereas *Myoxocephalus* and *Hemitripteris* groups have pigments only dorsolaterally.

Table 8. Development of meristic structures in *Tilesina gibbosa*.

Spec. No.	SL (mm)	Developmental stage	Dorsal fin		Anal fin rays	Pectoral fin rays	Pelvic fin rays	Bony plates				
			spines	rays				DLR+MDR	SLR	ILR	VLR+MVR	LLP
501	13.4	Flexion	0	9	23	14	Buds	4	47	46	10	0
502	13.9	Flexion	0	7	27	14	Buds	5	46	46	11	0
503	15.6	Flexion	0	9	26	15	Buds	31	46	48	40	0
504	16.6	Postflexion	10	8	26	16	Buds	25	46	48	40	0
505	17.6	Postflexion	19	8	25	15	Buds	47	47	49	43	0
506	18.9	Postflexion	20	9	26	15	Buds	49	48	49	44	0
507	20.5	Postflexion	21	8	27	16	Buds	50	48	49	45	0
508	20.9	Postflexion	20	7	25	15	Buds	49	47	48	45	0
509	23.9	Postflexion	19	8	26	15	Buds	48	48	49	45	0
510	28.2	Postflexion	18	8	26	15	Buds	50	49	50	45	3
511	30.8	Postflexion	19	8	26	16	3	51	49	51	46	19
512	31.1	Postflexion	20	8	26	16	I, 2	52	50	51	48	39
513	32.3	Postflexion	18	7	25	15	I, 2	51	48	50	46	45
514	33.8	Juvenile	19	9	26	15	I, 2	51	48	50	46	46

## 2. Subfamilies Tilesininae and Brachyopsinae

### *Tilesina gibbosa* Schmidt

Japanese name: Onishachi-uo (Fig. 13, Table 8)

#### 1) Specimens examined

Number of specimens, length of specimens and their developmental stages are shown in Table 8.

#### 2) Morphology

Meristic counts are shown in Table 8.

Body elongate, its depth slightly decreases proportionally from 5.0-6.5% of SL in flexion phase to 4.2-5.4% of SL in postflexion phase; snout to anus length decreases proportionally from 37.8-42.7% of SL in flexion phase to 33.8-41.0% of SL in postflexion phase; head length increases from 13.5-15.3% of SL in flexion phase to 19.2% of SL in largest specimen examined (33.8 mm SL); snout length increases

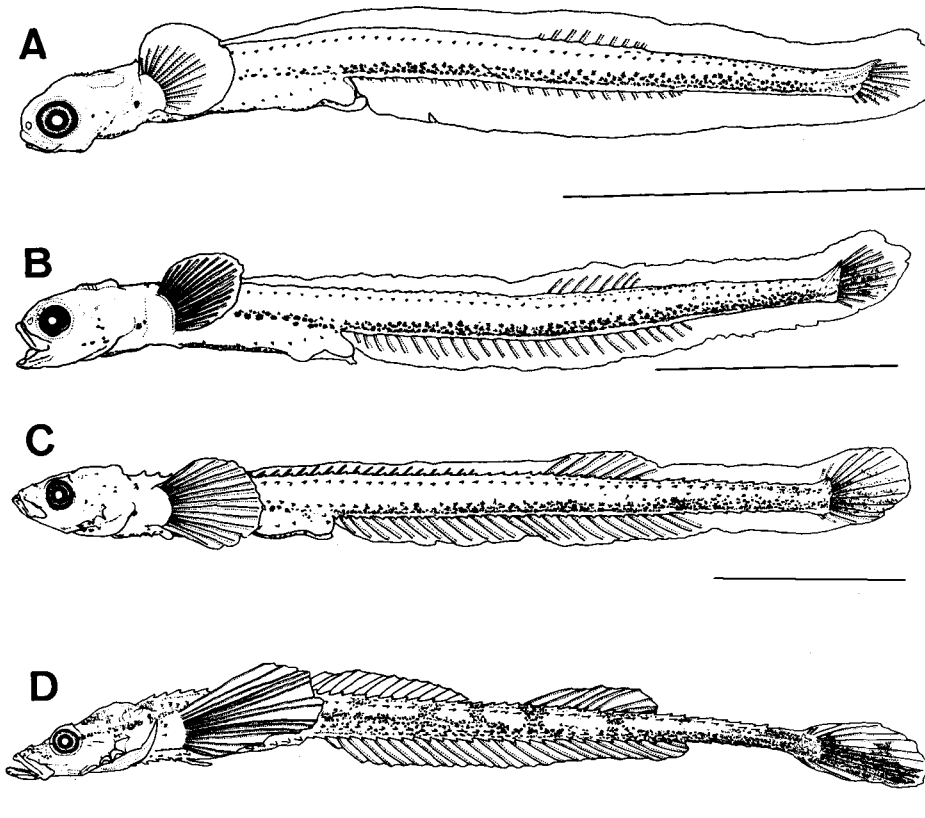

Fig. 13. Developmental series of *Tilesina gibbosa*. A, 13.4 mm larva; B, 16.6 mm larva; C, 20.9 mm larva; D, 33.8 mm juvenile. Each scale indicates 5 mm.

from 15.8-19.0% of HL in flexion phase to 20.0-26.7% of HL in postflexion phase; eye diameter decreases proportionally from 31.6-33.3% of HL in flexion phase to 18.3-28.0% of HL in postflexion phase; profile of abdomen slightly concave at middle; gill membranes united and free from isthmus; lower jaw protruding beyond upper jaw; nostril separates into two at 28.2 mm; notochord flexion already started in smallest specimen examined (13.4 mm SL), and completed at 16.6 mm.

A pair of nasal spines appears at 17.6 mm, and fuses at 23.9 mm; supraocular ridge with spine appears at 18.9 mm; smallest specimen examined has seven fronto-parietal spinules, but lacks fronto-parietal ridge; fronto-parietal ridge appears at 15.6 mm; fronto-parietal spinules disappear at 17.6 mm; preopercular spines increase in number and size to form double row (anterior and posterior) during postflexion phase; each row consists of four spines; each preopercular spine of anterior row gradually extends over each spine of posterior row and they fuse at their tips to form canal at 23.9 mm; a pair of posttemporal spines appears at 15.6 mm, and fuses at 28.2 mm; another spine appears just behind posttemporal spine at 28.2 mm; two pairs of postocular spines appear at 20.5 mm; each pair of postocular spines fuses at 28.2 mm; each third to fifth branchiostegal ray has small process near proximal tip (Fig. 30D).

Full complements of bony plates appear in DLR and VLR at 17.6 mm, in MDR and MVR at 30.8 mm and in SLR and ILR at 28.2 mm; full complements of LLP not formed in largest specimen examined; LLP extends backward as double row; all bony plates form initially as spines and later ossify basally to form bony plates of adults.

Full complements of fins appear in first dorsal fin at 17.6 mm and in pelvic fin at 30.8 mm; full complements of second dorsal, anal, and pectoral fins already present in smallest specimen examined; median finfold gradually degenerates and no longer visible at 33.8 mm; early larvae have small preanal finfold, which disappears at 33.8 mm; dorsal and anal fins do not migrate during development; first dorsal fin starts over middle of 6th-7th to 8th DLR and ends over 24th to middle of 26th-27th; second dorsal fin starts over middle of 30th-31st to middle of 32nd-33rd DLR and ends over 36th to 40th; anal fin starts under 12th to 13th VLR and ends under 36th to 38th; pectoral fin length increases from 8.9-9.6% of SL in flexion phase to 16.9% of SL in largest specimen examined; posterior end of pectoral fin reaches level of anus at 30.8-32.3 mm.

### 3) Pigmentation

Smallest specimen examined has row of melanophores extending along DLR from origin of second dorsal fin to caudal peduncle; origin of melanophore row gradually advances to below first dorsal fin during postflexion phase; ventrolateral body has heavily pigmented horizontal band along ILR and VLR extending from base of pectoral fin to caudal peduncle; isthmus has row of melanophores; in flexion and early postflexion phases (12.4-20.9 mm SL), no melanophores on fore-brain, while 3-13 melanophores present on midbrain and two to nine melanophores on hindbrain; lateral surface of brain starts to be heavily pigmented with small melanophores at 23.9 mm; gular region has two to six melanophores throughout development; row of melanophores lies along ventral midline of abdomen (Fig.

30D), extending from isthmus to anus in flexion phase and from pelvic fin base to anus in postflexion phase and juvenile period.

Dorsal and anal median finfolds have no melanophores throughout development; caudal fin pigmented on lower half in flexion phase; pigmented area on caudal fin gradually expands posteriorly to form large heavily pigmented blotch; pectoral and pelvic fins lack melanophores throughout development.

***Ocella dodecaedron* (Tilesius)**

Japanese name: Kamutosachi-uo (Fig. 14, Table 9)

1) Specimens examined

Number of specimens, length of specimens and their developmental stages are shown in Table 9.

2) Morphology

Meristic counts are shown in Table 9.

Body slender, its depth increases from 9.2-9.3% of SL in postflexion phase to 10.7-15.3% of SL in juvenile period; snout to anus length slightly decreases

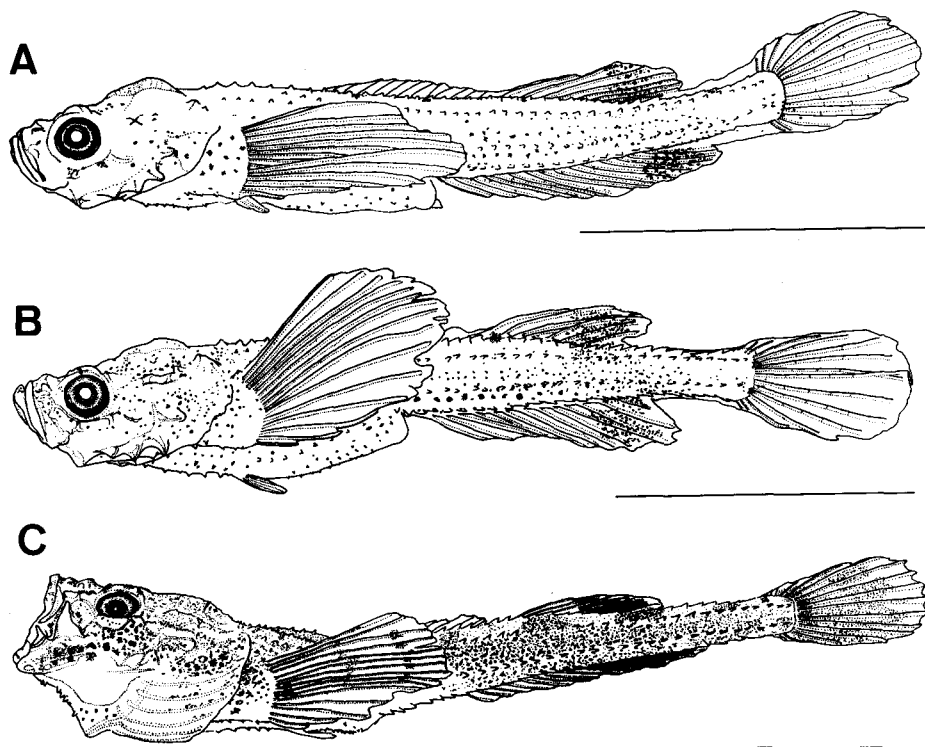

Fig. 14. Developmental series of *Ocella dodecaedron*. A, 10.7 mm larva; B, 12.0 mm larva; C, 21.4 mm juvenile. Each scale indicates 5 mm.

Table 9. Development of meristic structures in *Ocella dodecaedron*.

Spec. No.	SL (mm)	Developmental stage	Dorsal fin		Anal fin rays	Pectoral fin rays	Pelvic fin rays	Bony plates				
			spines	rays				DLR+MDR	SLR	ILR	VLR+MVR	LLP
601	10.7	Postflexion	12	8	15	15	I, 2	39	37	37	36	20
602	12.0	Postflexion	10	7	13	15	I, 2	39	36	37	36	29
603	14.1	Juvenile	9	8	15	15	I, 2	38	35	37	37	25
604	17.8	Juvenile	10	8	15	15	I, 2	38	36	39	36	37
605	18.6	Juvenile	11	9	14	15	I, 2	39	36	39	36	30
606	19.6	Juvenile	10	7	15	14	I, 2	38	37	38	35	40
607	20.9	Juvenile	9	9	15	14	I, 2	39	38	38	38	40
608	21.4	Juvenile	10	7	15	15	I, 2	39	36	39	37	40

Table 10. Meristic structures in *Ocella* sp.

Spec. No.	SL (mm)	Developmental stage	Dorsal fin		Anal fin rays	Pectoral fin rays	Pelvic fin rays	Bony plates				
			spines	rays				DLR+MDR	SLR	ILR	VLR+MVR	LLP
701	10.9	Postflexion	15	10	15	18	Buds	39	39	41	9	0

proportionally from 52.5-54.2% of SL in postflexion phase to 43.5-50.4% of SL in juvenile period; head length 25.7 to 29.0% of SL; snout length 13.2% to 22.2% of HL in juvenile period; tip of snout blunt throughout development; eye diameter slightly decreases proportionally from 23.3-23.5% of HL in postflexion phase to 20.4-22.2% of HL in juvenile period; profile of abdomen slightly bulged in postflexion phase, but almost flat in juvenile period; gill membranes united and free from isthmus; mouth extremely oblique; lower jaw protruded beyond upper jaw; nostril already separated into two in smallest specimen examined (10.7 mm SL); notochord flexion already completed in smallest specimen examined.

Nasal spine already present in smallest specimen examined; supraocular ridge without spines present in postflexion phase; upper edge of supraocular ridge serrated in larger juveniles; low fronto-parietal ridge present; four preopercular spines present in smallest specimen examined; postocular ridge with canal already formed in smallest specimen examined; large projection present on posttemporal region in postflexion phase, and inconspicuous in juvenile period; each third to fifth branchiostegal ray has small process near proximal tip (Fig. 30E).

Full complements of bony plates in all rows, except for LLP, already present in smallest specimen examined; full complements of LLP appear at 19.6 mm; LLP extends backward as double row; a few bony plates on gill membranes and many bony plates on gular region; small bony plates scattered on ventral surface of abdomen; all bony plates form initially as spines and later ossify basally to form bony plates of adults.

Full complements of all fins already acquired in smallest specimen examined; median finfold gradually degenerates, persists as rudiment at 12.0 mm, and no longer visible at 14.1 mm; smallest larva has small preanal finfold, which disappears at 12.0 mm; dorsal and anal fins do not migrate throughout development; first dorsal fin starts over eighth to ninth DLR and ends over 17th to 19th; second dorsal fin starts over 21st to 22nd DLR and ends over middle of 27th-28th to 29th; anal fin starts under middle of 13th-14th to 16th VLR and ends under middle of 26th-27th to 30th; pectoral fin length decreases proportionally from 28.0-29.2% of SL in postflexion phase to 20.4-25.5% of SL in juvenile period; posterior end of pectoral fin already beyond level of anus in smallest specimen examined.

### 3) Pigmentation

In postflexion phase, dorsal margin of body has four small blotches; first situated below anterior part of first dorsal fin, second below posterior part of first dorsal fin, third below origin of second dorsal fin, and fourth on dorsal margin of caudal peduncle; lateral surface of body has row of melanophores between ILR and VLR, and irregularly pigmented between SLR and ILR; juveniles have five vertical indistinct bands on lateral surface of body; a few melanophores present on posterior part of gill membranes in postflexion phase and juvenile period; a few melanophores on isthmus and gular region; row of melanophores extends along ventral midline of abdomen from base of pelvic fin to anus (Fig. 30E); fore-, mid- and hindbrain already pigmented in smallest specimen examined.

Dorsal and anal fins have large blotch on their posterior parts; in postflexion phase, caudal fin has two small blotches on base; in juvenile period, entire caudal

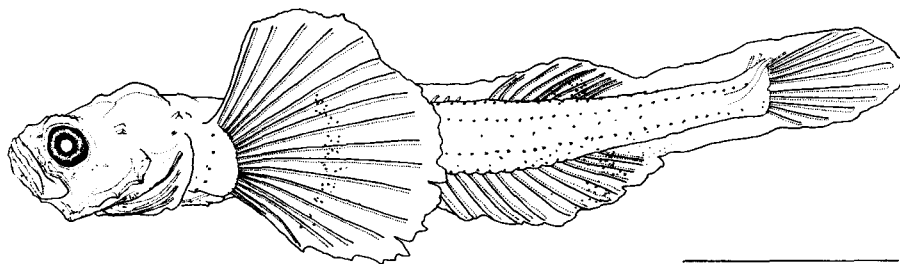

Fig. 15. Larva of *Ocella* sp. 10.9 mm. Scale indicates 3 mm.

fin heavily pigmented except for posterodorsal part; pectoral fin unpigmented in postflexion phase, but has three pigmented bands in juvenile period; pelvic fin lacks melanophores throughout development.

***Ocella* sp.**

(Fig. 15, Table 10)

1) Specimen examined

Number of specimen, length of specimen and its developmental stage are shown in Table 10.

2) Morphology

Meristic counts are shown in Table 10.

Body elongate, its depth 9.2% of SL; snout to anus length 55.0% of SL; head length 24.8% of SL; snout length 22.2% of HL; eye diameter 22.2% of HL; profile of abdomen bulged; gill membranes joined and free from isthmus; mouth extremely oblique; lower jaw protruded beyond upper jaw; nostril not separated yet; notochord flexion already completed.

Nasal spine present; supraocular ridge with five spines; fronto-parietal ridge present, its upper edge slightly constricted anteriorly; a pair of postocular spines present; posttemporal spine present; another spine present just behind posttemporal spine; four preopercular spines present; each third to fifth branchiostegal ray has small process near proximal tip.

Full complements of bony plates present in DLR, SLR and ILR, but not in MDR, VLR, MVR and LLP; a few minute bony plates present on middle of gill membranes and posterior part of gular region.

Full complements of all fins, except for pelvic fin, already acquired; first dorsal fin starts over middle of 6th-7th DLR and ends over middle of 20th-21st; second dorsal fin starts over middle of 23rd-24th DLR and ends over 32nd; pectoral fin large, its length 27.5% of SL; posterior end of pectoral fin already beyond level of anus; median finfold still high, but preanal finfold absent.

3) Pigmentation

Row of melanophores present on lateral side of body between SLR and ILR, extending from origin of second dorsal fin to posterior end of anal fin; another irregular row of melanophores lies on ventrolateral body between ILR and VLR;

melanophores scattered on posterolateral surface of abdomen ; row of melanophores present on ventral midline of abdomen ; 3 melanophores present on gular region ; gill membranes has a few melanophores on bases of third to sixth branchiostegal rays ; fore-, mid- and hindbrain unpigmented.

Median finfold has blotch in posterior regions of second dorsal and anal fins, and has several melanophores on median anal finfold posterior to anal fin ; pectoral fin has pigmented band on middle part between fifth and 16th rays and dorsal margin ; pelvic fin unpigmented.

***Brachyopsis rostratus* (Tilesius)**

Japanese name : Shichiro-uo (Fig. 16, Table 11)

1) Specimens examined

Number of specimens, length of specimens and their developmental stages are shown in Table 11.

2) Morphology

Meristic counts are shown in Table 11.

Body slender, its depth decreases proportionally from 8.1-9.2% of SL in early postflexion phase (11.3-13.1 mm SL) to 6.7-7.3% of SL in late postflexion phase (18.1-20.7 mm SL) ; snout to anus length decreases proportionally from 48.0-54.2% of SL in early postflexion phase to 42.0-45.3% of SL in late postflexion phase ; head length increases slightly from 20.4-22.9% of SL in early preflexion phase to 23.2-24.7% of SL in late postflexion phase ; snout length increases from 17.4-22.2% of HL in early postflexion phase to 23.5-27.1% of HL in late postflexion phase ; eye diameter decreases proportionally from 23.3-30.4% of HL in early postflexion phase to 18.8-20.9% of HL in late postflexion phase ; profile of abdomen constricted into two parts in early postflexion phase and flattens in late postflexion phase ; gill membranes united and free from isthmus ; mouth oblique ; lower jaw protruded beyond upper jaw ; nostril separates into two at 13.1-15.3 mm ; notochord flexion already completed in smallest specimen examined (11.3 mm SL).

A pair of nasal spines appears at 11.6 mm, and fuse at 15.3 mm ; smallest specimen examined has a supraocular ridge with a spine ; fronto-parietal ridge well developed in smallest specimen examined, its upper edge highest at middle part ; preopercular spines increase in number and size during early postflexion phase to form double row (anterior and posterior) ; each row composed of four spines ; each spine of anterior row gradually extends over each spine of posterior row to form ridge with canal during late postflexion phase ; a pair of posttemporal spines present in smallest specimen examined, and fuses at 12.5 mm ; a pair of anterior postocular spines formed at 11.3-12.5 mm and fuses at 13.1 mm ; a pair of posterior postocular spines formed at 13.1-15.3 mm, and fuses at 18.1 mm ; each third to fifth branchiostegal ray has small process near proximal tip.

Full complements of bony plates in all rows, except for LLP, appear at 16.5 mm ; LLP not completed posteriorly in largest specimen examined (21.9 mm SL).

Full complements of all fins except for pelvic fin already acquired in smallest specimen examined ; adult complements of pelvic fin rays appear at 18.1 mm ;

Table 11. Development of meristic structures in *Brachyopsis rostratus*.

Spec. No.	SL (mm)	Developmental stage	Dorsal fin		Anal fin rays	Pectoral fin rays	Pelvic fin rays	Bony plates				
			spines	rays				DLR+MDR	SLR	ILR	VLR+MVR	LLP
801	11.3	Postflexion	10	8	13	15	Buds	40	34	41	25	0
802	11.6	Postflexion	9	8	13	15	Buds	42	34	40	26	0
803	12.4	Postflexion	7	9	13	14	Buds	40	34	40	28	0
804	12.5	Postflexion	8	9	13	15	Buds	41	33	39	25	0
805	12.9	Postflexion	8	8	14	14	Buds	39	35	41	36	0
806	13.1	Postflexion	8	8	12	14	Buds	41	34	40	37	0
807	14.4	Postflexion	7	8	12	15	Buds	41	34	40	36	0
808	15.3	Postflexion	8	9	13	14	Buds	40	35	41	36	0
809	16.5	Postflexion	8	8	13	14	Buds	41	35	41	42	5
810	18.1	Postflexion	7	8	13	14	3	42	37	42	39	6
811	19.1	Postflexion	9	8	13	14	I, 2	43	35	41	38	5
812	20.7	Postflexion	8	8	12	15	I, 2	43	36	42	38	24
813	21.9	Juvenile	8	8	12	15	I, 2	43	35	42	37	21

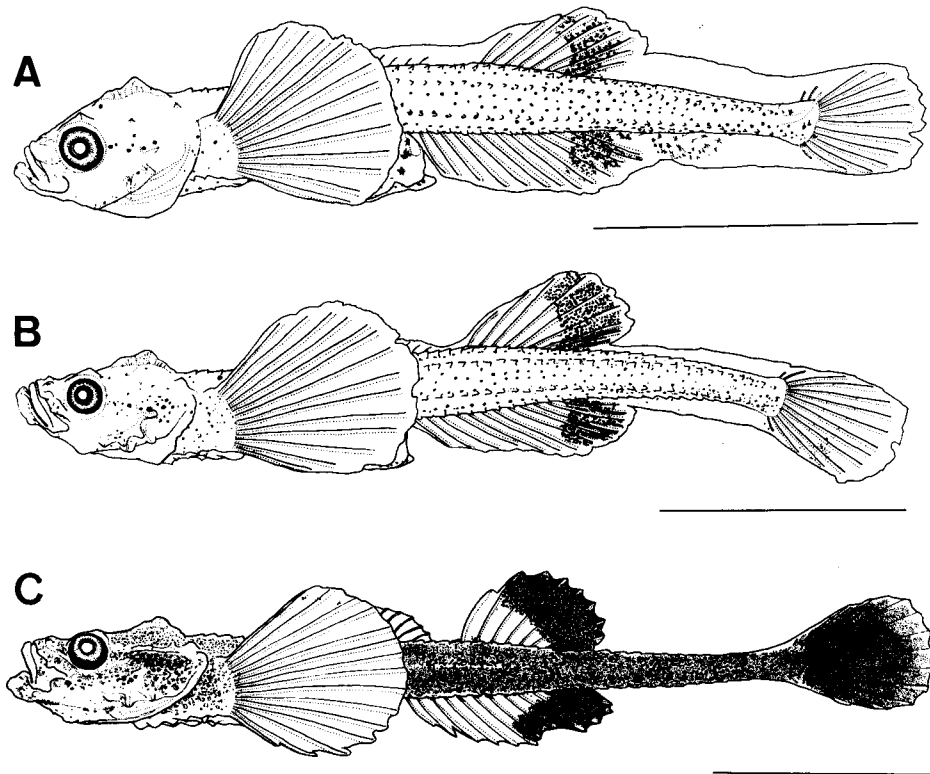

Fig. 16. Developmental series of *Brachyopsis rostratus*. A, 12.4 mm larva; B, 15.3 mm larva; C, 21.9 mm juvenile. Each scale indicates 5 mm.

median finfold gradually degenerates, lost entirely in largest specimen examined; early larvae have small preanal finfold, which disappears at 21.9 mm; dorsal and anal fins do not migrate during larval and juvenile periods; first dorsal fin starts over middle of 9th-10th to 11th DLR and ends over middle of 16th-17th to middle of 18th-19th; second dorsal fin starts over 21st to 23rd DLR and ends over 28th to 30th; anal fin starts under middle of 11th-12th to 14th VLR and ends under middle of 22nd-23rd to 25th; pectoral fin length increases during early postflexion phase from 11.5 to 25.7% of SL, and decreases proportionally during late postflexion phase from 24.9 to 20.8% of SL; posterior end of pectoral fin reaches level of anus at 14.4 mm; pectoral fin fan-shaped.

### 3) Pigmentation

Lateral surface of body has melanophore row on DLR, SLR, ILR and VLR and about two rows between SLR and ILR; row of melanophores on DLR extends from middle of second dorsal fin to caudal peduncle in smallest specimen examined; origin of row gradually advances to reach lateral side of nape; lateral surface of body rapidly becomes heavily pigmented at 16.5 mm; fore-, mid- and hindbrain already pigmented in smallest specimen examined; in early postflexion phase, one

to four melanophores on forebrain, two to eight on midbrain and two to six on hindbrain; each brain region rapidly becomes heavily pigmented at 16.5 mm; one to five melanophores on gular region in early postflexion phase.

Median finfold has large blotch on posterior parts of second dorsal and anal fins; base of first dorsal fin starts to be pigmented with a few melanophores at 16.5 mm; median finfolds, between first and second dorsal fins and between second dorsal and caudal fins, unpigmented throughout development; number of melanophores on anal median finfold between anal and caudal fins changes from six at 11.3-13.6 mm to 13-30 at 12.4-13.1 mm and to seven to nine at 19.1-21.9 mm; caudal fin unpigmented in smallest specimen examined, becomes pigmented at 12.4 mm; pigmented area on caudal fin gradually expands to occupy all but its margin at 18.1 mm; pectoral fin unpigmented in larvae less than 15.3 mm, but one specimen (12.4 mm SL) with a few melanophores on base of upper half; a few melanophores appear on base of upper pectoral fin at 16.5 mm, and on its upper margin at 21.9 mm; pelvic fin lacks melanophores throughout development.

*Pallasina* sp.

(Fig. 17, Table 12)

1) Specimens examined

Number of specimens, length of specimens and their developmental stages are shown in Table 12.

2) Morphology

Meristic counts are shown in Table 12.

Body elongate, its depth decreases slightly from 6.6% of SL in smallest specimen examined (7.6 mm SL) to 5.2% of SL in largest specimen examined (21.0 mm SL); snout to anus length decreases proportionally from 47.4-50.5% of SL in flexion phase to 44.3-44.8% of SL in postflexion phase; head length increases from 18.4-19.6% of SL in late flexion phase to 22.2-24.4% of SL in late postflexion phase (18.3-21.0 mm); snout length increases from 14.3% of HL in smallest specimen examined to 32.7% of HL in largest specimen examined; eye diameter decreases proportionally from 35.7% of HL in smallest specimen examined to 16.3% of HL in largest specimen examined; profile of abdomen slightly constricted into two parts; gill membranes united and free from isthmus; lower jaw protruded beyond upper jaw; nostril separates into two at 14.9-17.2 mm; notochord slightly flexed in smallest specimen examined; notochord flexion completed at 10.2 mm.

A pair of nasal spines appears at 14.9 mm and fuses at 13.8 mm; supraocular ridge with one spine appears at 9.7 mm; fronto-parietal ridge appears at 9.7 mm; preopercular spines increase in number and size to form double row (anterior and posterior) in late postflexion phase; each row consists of four spines; each preopercular spine of anterior row gradually extends over each spine of posterior row and fuses at tip to form canal at 14.9 mm; a pair of the posttemporal spines appears at 10.2 mm, and fuses at 14.9 mm; two pairs of postocular spines formed between 12.7 mm and 17.2 mm; each pair fuses at 18.3 mm; each second to fourth branchiostegal ray has small spiny process near proximal tip (Fig. 30F).

Full complements of bony plates appear in DLR at 9.7 mm, in MDR at 14.9 mm,

Table 12. Development of meristic structures in *Pallasina* sp.

Spec. No.	SL (mm)	Developmental stage	Dorsal fin		Anal fin rays	Pectoral fin rays	Pelvic fin rays	Bony plates				
			spines	rays				DLR+MDR	SLR	ILR	VLR+MVR	LLP
901	7.6	Flexion	0	8	11	12	Buds	12	30	37	2	0
902	9.7	Postflexion	5	7	10	13	Buds	34	32	39	27	0
903	10.2	Postflexion	6	8	12	13	Buds	36	32	41	38	0
904	11.6	Postflexion	5	8	11	12	Buds	38	33	40	37	0
905	12.7	Postflexion	6	8	11	11	Buds	42	36	45	41	0
906	13.8	Postflexion	7	7	11	12	Buds	41	33	43	38	0
907	14.9	Postflexion	6	7	10	11	Buds	42	34	41	41	0
908	15.7	Postflexion	6	8	12	12	Buds	43	36	43	39	0
909	17.2	Postflexion	6	8	10	11	Buds	43	36	45	41	0
910	18.3	Postflexion	5	6	10	11	Buds	43	35	44	43	8
911	21.0	Postflexion	5	8	11	11	Buds	42	36	45	41	23

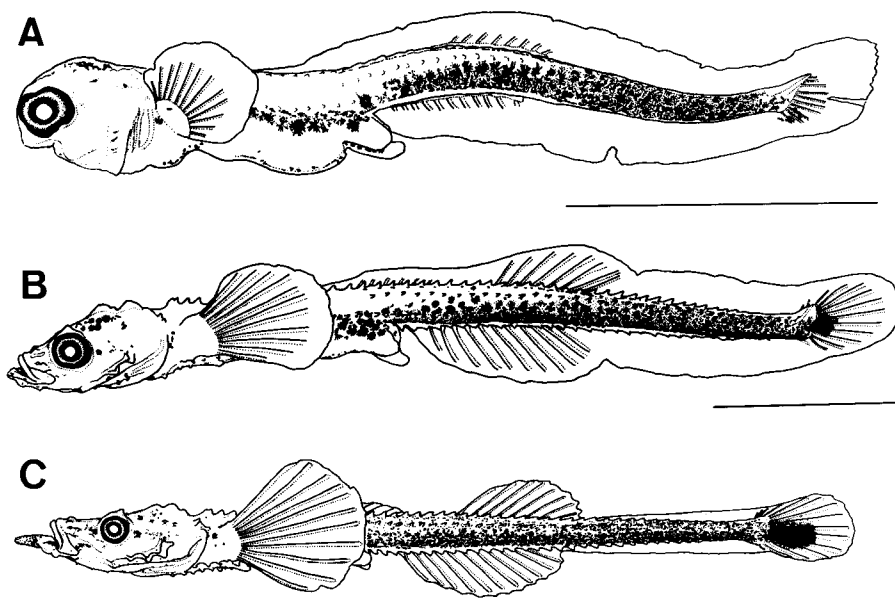

Fig. 17. Larvae of *Pallasina* sp. A, 7.6 mm; B, 12.7 mm; C, 21.0 mm. Each scale indicates 3 mm.

in SLR and ILR at 12.7 mm, in VLR at 10.2 mm and in MVR at 14.9 mm; adult complements of LLP not acquired in largest specimen examined; LLP extends backward as double row; all bony plates form initially as spines and later ossify basally to form bony plates of adults.

Full complements of first dorsal fin appear at 10.2 mm; full complements of second dorsal, anal and pectoral fins already acquired in smallest specimen examined, but not formed in pelvic fin in largest specimen examined; median finfold gradually degenerates with development; dorsal median finfold between first and second dorsal fins disappears at 18.3 mm; median finfolds, between second dorsal and caudal fins and between anal and caudal fins, persist in largest specimen examined; early larvae have small preanal finfold, which disappears at 18.3 mm; dorsal and anal fins do not migrate during development; first dorsal fin starts over middle of 12th-13th to 14th DLR and ends over middle of 16th-17th to middle of 19th-20th; second dorsal fin starts over middle of 21st-22nd to middle of 24th-25th DLR and ends over middle of 27th-28th to middle of 30th-31st; anal fin starts under middle of 14th-15th to middle of 17th-18th VLR and ends under 24th to 27th; pectoral fin length increases from 9.2% of SL in smallest specimen examined to 17.1-19.1% in late postflexion phase; posterior end of pectoral fin reaches level of anus at 18.3 mm; barbel appears on tip of lower jaw at 17.2 mm.

### 3) Pigmentation

Lateral surface of body posterior to end of second dorsal fin heavily pigmented wholly; lower half of body between anus and end of body heavily pigmented; row

of melanophores lies below DLR and starts from somewhat anterior to second dorsal fin; dorsolateral surface of gut has large melanophores; row of melanophores lies along ventral midline of abdomen from slightly anterior to pelvic fin to anus (Fig. 30F); isthmus has row of melanophores; smallest specimen examined already has a few melanophores on mid- and hindbrain, but lacks melanophores on forebrain; forebrain has 0-5 melanophores at 9.7-17.2 mm; dorsal surface of brain starts to be heavily pigmented with small melanophores at 18.3 mm; melanophores on gular region present or absent in flexion and early postflexion phases (7.6-17.2 mm SL); gular region heavily pigmented in late postflexion phase (18.3-21.0 mm SL).

Median finfold unpigmented in all specimens except for one (10.2 mm SL) which has a few melanophores below ventral margin of body; smallest specimen examined has a few melanophores on lower caudal fin rays; pigmented area on caudal fin gradually expands to form large blotch on its lower half; pectoral fin unpigmented throughout development; pelvic fin unpigmented except for one (9.7 mm SL) which has melanophore on its base.

### Summary and comparison of Tilesininae and Brachyopsinae

#### 1) Identification

The five developmental tilesinine and brachyopsine series are linked together by pigment patterns and meristic structures (fin rays and bony plates). *Tilesina gibbosa* is recognized as a tilesinine species by having more than 17 spines on the first dorsal fin and more than 24 rays on the anal fin (Jordan and Starks, 1904; Matsubara, 1955). The other four series are allied to Brachyopsinae by four characters: (1) 5-15 first dorsal fin spines, (2) gill membranes united and free from the isthmus, (3) lower jaw protruding beyond upper, and (4) first dorsal fin starts behind nape (Jordan and Starks, 1904; Matsubara, 1955; Kanayama, 1984). Each series of Tilesininae and Brachyopsinae are identified by a combination of meristic structures (Table 13). *Tilesina gibbosa* is the only tilesinine species recorded from Japan. *Ocella dodecaedron* is identified by having 9-12 spines on the first dorsal fin, 13-15 rays on the anal fin and 37-39 bony plates on ILR. The third series has characters of *Ocella iburia* and *O. kasawai*. Like *O. iburia* it has 10 rays on the second dorsal fin, and like *O. kasawai* it has 15 spines on the first dorsal fin and 15 rays on the anal fin. Consequently, this series is described and discussed as *Ocella* sp. *Brachyopsis rostratus* is identified by having 7-10 rays on the first dorsal fin, 14-15 rays on the pectoral fin, 12-14 rays on the anal fin, and 40-42 bony plates on ILR. The fifth series belongs to the genus *Pallasina* in having five to seven spines on the first dorsal fin and 11-13 rays on the pectoral fin. Two species of *Pallasina* are recorded from Japan, *P. barbata* and *P. eryngia*. Adults are separated only by the length of the barbel on the tip of the lower jaw, and cannot be distinguished by meristic characters (Table 13). Our series cannot be identified to the species, because its barbel is not sufficiently developed.

#### 2) Comparison of other useful characters for identification

*Body depth.* — In the postflexion phase, tilesinine and brachyopsine species are divided into two groups according to the body depth. The first group consists of

Table 13. Comparison of meristic counts between present larvae and juveniles and adults Kanayama (1984).

	Larvae and juveniles					
	<i>Tilesina gibbosa</i>	<i>Ocella dodecaedron</i>	<i>Ocella</i> sp.	<i>Brachyopsis rostratus</i>	<i>Pallasina</i> sp.	<i>Tilesina gibbosa</i>
First dorsal spines	18-21	9-12	15	7-10	5-7	17-21
Second dorsal rays	7-9	7-9	10	8-9	6-8	6-9
Anal fin rays	25-27	13-15	15	12-14	10-12	23-27
Pectoral fin rays	15-16	14-15	18	14-15	11-13	13-16
DLR+MDR	51-52	38-39	39*	42-43	42-43	46-67
SLR	48-50	35-38	39	34-37	33-36	46-49
ILR	50-51	37-38	41	40-42	44-45	48-51
VLR+MVR	46-48	35-38	9*	37-42	39-43	42-53

\* Incomplete.

*Tilesina gibbosa* and *Pallasina* sp. In this group, the body is elongate, and its depth is 4.2-5.4% of SL in *T. gibbosa* and 5.2-6.0% of SL in *Pallasina* sp. The second group consists of *Ocella dodecaedron*, *Ocella* sp. and *Brachyopsis rostratus*. In this group, the body is slender, and its depth is 9.2-9.3% of SL in *O. dodecaedron*, 9.2% of SL in *Ocella* sp. and 6.7-9.2% of SL in *B. rostratus*.

*Head length.* — In the postflexion phase, tilesinine and brachyopsine species are divided into three groups according to the head length. The first group is composed of only one species, *Tilesina gibbosa*. The head length of *T. gibbosa* is proportionally shortest, and is 14.2-18.6% of SL. The second group includes *Ocella* sp., *Brachyopsis rostratus* and *Pallasina* sp. The head length in this group is proportionally moderate, and is 24.8% of SL in *Ocella* sp., 20.4-24.7% of SL in *B. rostratus* and 18.6-24.4% of SL in *Pallasina* sp. The third group comprises *Ocella dodecaedron*. The head length of *O. dodecaedron* is proportionally longest, and is 28.0-28.3% of SL.

*Notochord flexion.* — Notochord flexion is completed earlier in brachyopsine species than in tilesinine species. Notochord flexion is completed at 10.2 mm in *Pallasina* sp., and already completed at 10.7 mm in *O. dodecaedron*, at 10.9 mm in *Ocella* sp. and at 11.3 mm in *B. rostratus*. On the other hand, notochord flexion is completed at 16.6 mm in *Tilesina gibbosa*.

*Lateral body surface pigment.* — The pigment patterns of the lateral surface of the body provide useful characters for identification, particularly in the larval period. Larvae of Tilesininae and Brachyopsinae fall into two groups according to the pigmentation of the lateral body surface. The first group comprises *Tilesina gibbosa* and *Pallasina* sp. In this group, the ventrolateral surface of the body is heavily pigmented to form a horizontal band along ILR and VLR. *T. gibbosa* is separable from *Pallasina* sp. by the pigment patterns of the dorsolateral surface of

of eight species of Tilesininae and Brachyopsinae in Japan. Adult's data are from

Adults						
<i>Ocella dodecaedron</i>	<i>Ocella iburia</i>	<i>Ocella kuronumai</i>	<i>Ocella kasawai</i>	<i>Brachyopsis rostratus</i>	<i>Pallasina barbata</i>	<i>Pallasina eryngia</i>
8-11	12-14	11-13	13-15	7-9	5-8	5-6
6-9	8-10	9-10	8-9	6-9	7-9	6-8
13-16	16-18	17-20	15-17	12-15	9-11	8-12
14-16	16-19	15-17	17-19	14-15	11-13	10-12
34-44	38-48	37-46	38-48	34-52	41-51	39-58
36-39	35-40	34-38	38-42	33-38	32-36	35-42
36-39	39-43	39-42	37-43	39-43	40-45	44-48
31-43	36-47	36-45	36-44	34-45	39-47	38-52

the body. The dorsolateral surface of the body posterior to the end of the second dorsal fin is heavily pigmented in *Pallasina* sp. (Fig. 17A, B), but is not heavily pigmented in *T. gibbosa* (Fig. 13A, B). The second group is composed of *Ocella dodecaedron*, *Ocella* sp. and *Brachyopsis rostratus*. In this group, the ventrolateral surface of the body lacks the dark horizontal band. These three species are, however, distinguished from each other by pigment patterns of the dorsolateral surface of the body. *O. dodecaedron* (Fig. 14A, B) differs from the other two species in having four small blotches on the dorsal margin of the body (lacking in the latter). *B. rostratus* is distinguished from the other two species in having a row of melanophores on the dorsal margin of the body along DLR (Fig. 16A, B).

*Dorsal and anal fins.*—The species of Tilesininae and Brachyopsinae are divided into two groups according to the pigment patterns of the dorsal and anal fins. The first group is composed of *Tilesina gibbosa* and *Pallasina* sp. In this group, the dorsal and anal fins are unpigmented (Figs. 13 and 17). The second group includes the members of the genus *Ocella* and *Brachyopsis rostratus*. The species of this group have a large blotch on the posterior part of the second dorsal and anal fins (Figs. 14, 15 and 16).

*Pectoral fin.*—Tilesinine and brachyopsine species fall into two groups according to the pigment pattern of the pectoral fin. The first group consists of *Tilesina gibbosa*, *Brachyopsis rostratus* and *Pallasina* sp. In this group, the pectoral fin is unpigmented or weakly pigmented on its base and upper margin. *T. gibbosa* and *Pallasina* sp. lack melanophores on the pectoral fin throughout development (Figs. 13 and 17). On the other hand, *B. rostratus* has no melanophores in the early postflexion larval phase (11.3-15.3 mm SL, Fig. 16A, B), but has a few melanophores on the base and the upper margin of the fin in the late postflexion phase and the juvenile period (16.5-21.9 mm SL, Fig. 16C). The second group contains the species of the genus *Ocella*. Both species of this group have one or three bands on the pectoral

fin. However, these two species can be distinguished by the developmental stage when the pigmented bands appear. *O. dodecaedron* lacks melanophores on the fin in the postflexion larval phase (10.7–12.0 mm SL, Fig. 14A), but has three pigmented bands in the juvenile period (14.1–21.4 mm SL, Fig. 14B). *Ocella* sp. has a pigmented band on the fin already in the postflexion larval phase (10.9 mm SL, Fig. 15).

### 3) Comparison with other brachyopsine species

Washington *et al.* (1984) illustrated the postflexion larvae of *Ocella verrucosa* (10.1 mm SL) without description. Judging from their illustration, *Ocella verrucosa* is similar to *O. dodecaedron* and *Ocella* sp. in having a pigmented band on the pectoral fin. However, the former species is distinguished from the latter two by the pigment pattern of the dorsal and anal fins. *O. dodecaedron* and *Ocella* sp. have a large blotch posteriorly on the dorsal and anal fins (Figs. 14 and 15), while *O. verrucosa* lacks these blotches (Washington *et al.* 1984, Fig. 232E).

## 3. Subfamily Agoninae

### *Podothecus sachi* (Jordan and Snyder)

Japanese name: Tokubire (Fig. 18, Table 14)

#### 1) Specimens examined

Number of specimens, length of specimens and their developmental stages are shown in Table 14.

#### 2) Morphology

Meristic counts are shown in Table 14.

Body slender, its depth 7.1 to 9.7% of SL throughout larval and juvenile periods; snout to anus length does not change markedly with development, and 47.1 to 55.2% of SL; head length increases from 20.9–23.0% of SL in preflexion phase to 29.4–32.1% of SL in juvenile period; snout length increases from 22.7–29.6% of HL in flexion larvae to 39.7–44.8% of HL in juveniles; tip of snout blunt in early larval period, becomes pointed rapidly in late larval period (about 18 mm SL); eye diameter decreases proportionally from 31.6% of HL in smallest specimen examined (8.3 mm SL) to 14.9% of HL in largest (25.1 mm SL); profile of abdomen constricted into two parts and flattens in juvenile period; gill membranes joined to isthmus; nostril separates into two at 13.1 mm; notochord flexion starts at 10.7–11.1 mm and completes at 13.1 mm.

Nasal spine first recognized at 11.2 mm, and obvious at 13–14 mm; ethmoid spine starts to form just behind nasal spine at about 16 mm; supraocular ridge with one spine appears at 10.8 mm; another spine appears on mesial side of posterior end of supraocular ridge at 18.7 mm; upper edge of fronto-parietal ridge with two to five spinules has two or three concavities in flexion larvae; fronto-parietal spinules disappear at 12.1–13.4 mm; preopercular spines increase in number and size during flexion phase to form two rows (anterior and posterior); each row composed of four spines; each spine of anterior row gradually extends over each spine of posterior row to form ridge for canal during postflexion phase; a pair of posttemporal spines

Table 14. Development of meristic structures in *Podothecus sachi*.

Spec. No.	SL (mm)	Developmental stage	Dorsal fin		Anal fin rays	Pectoral fin rays	Pelvic fin rays	Bony plates				
			spines	rays				DLR+MDR	SLR	ILR	VLR+MVR	LLP
1001	8.3	Preflexion	0	11	12	17	Buds	3	26**	26	6	?
1002	8.3	Preflexion	0	5	0	16	Buds	3	33**	29	7	?
1003	10.8	Flexion	9	13	16	17	Buds	13	36**	30	7	?
1004	10.9	Preflexion	7	14	15	17	Buds	17	37**	34	8	?
1005	10.9	Preflexion	8	13	14	17	Buds	13	34**	33	8	?
1006	11.1	Flexion	9	14	16	16	Buds	25	35**	37	8	?
1007	11.2	Flexion	8	14	16	17	Buds	23	30**	36	27	?
1008	11.2	Flexion	9	12	16	17	Buds	32	39**	37	22	?
1009	12.1	Flexion	9	14	15	17	Buds	36	35**	36	33	?
1010	13.1	Postflexion	9	12	17	17	Buds	36	38**	39	35	?
1011	13.4	Postflexion	9	13	16	16	Buds	35	38**	38	34	?
1012	13.4	Postflexion	9	13	16	17	Buds	37	40**	39	34	?
1013	14.3	Postflexion	8	14	15	17	Buds	37	39**	39	34	?
1014	14.5	Postflexion	9	13	15	17	Buds	37	39**	37	35	?
1015	15.1	Postflexion	8	13	16	18	Buds	36	39**	37	34	?
1016	15.6	Postflexion	9	13	15	17	Buds	36	39**	37	35	?
1017	16.6	Postflexion	9	12	15	17	Buds	38	41**	38	37	?
1018	16.6	Postflexion	9	14	17	17	3	37	41**	38	35	?
1019	17.7	Postflexion	9	13	16	17	3	37	40**	38	34	?
1020	17.8	Postflexion	9	14	16	18, 17*	3	37	41**	39	36	?
1021	18.3	Postflexion	8	13	16	18	3	38	41**	39	38	?
1022	18.3	Postflexion	9	13	16	18	3	37	41**	39	37	?
1023	18.7	Postflexion	9	13	16	17	I, 2	39	39**	38	38	?
1024	19.4	Postflexion	9	13	16	18, 17*	I, 2	39	33	39	37	8+24***
1025	19.6	Postflexion	9	13	16	17	I, 2	39	41**	38	37	?
1026	20.6	Juvenile	9	12	16	17	I, 2	40	32	39	39	8+9***
1027	21.0	Juvenile	9	13	16	16	I, 2	39	32	38	37	8+12***
1028	21.3	Juvenile	9	12	16	17	I, 2	40	34	39	39	8+15***
1029	21.4	Juvenile	8	13	15	17	I, 2	39	30	39	36	10+26***
1030	21.8	Juvenile	8	12	16	18	I, 2	37	33	39	36	7+21***
1031	22.4	Juvenile	8	12	15	17	I, 2	40	31	38	37	8+32***
1032	25.1	Juvenile	8	14	16	16	I, 2	39	31	38	38	9+28***

\* Right side.

\*\* The number includes LLP, because the anterior part of LLP cannot be distinguished from SLR.

\*\*\* ALLP+PLLP.

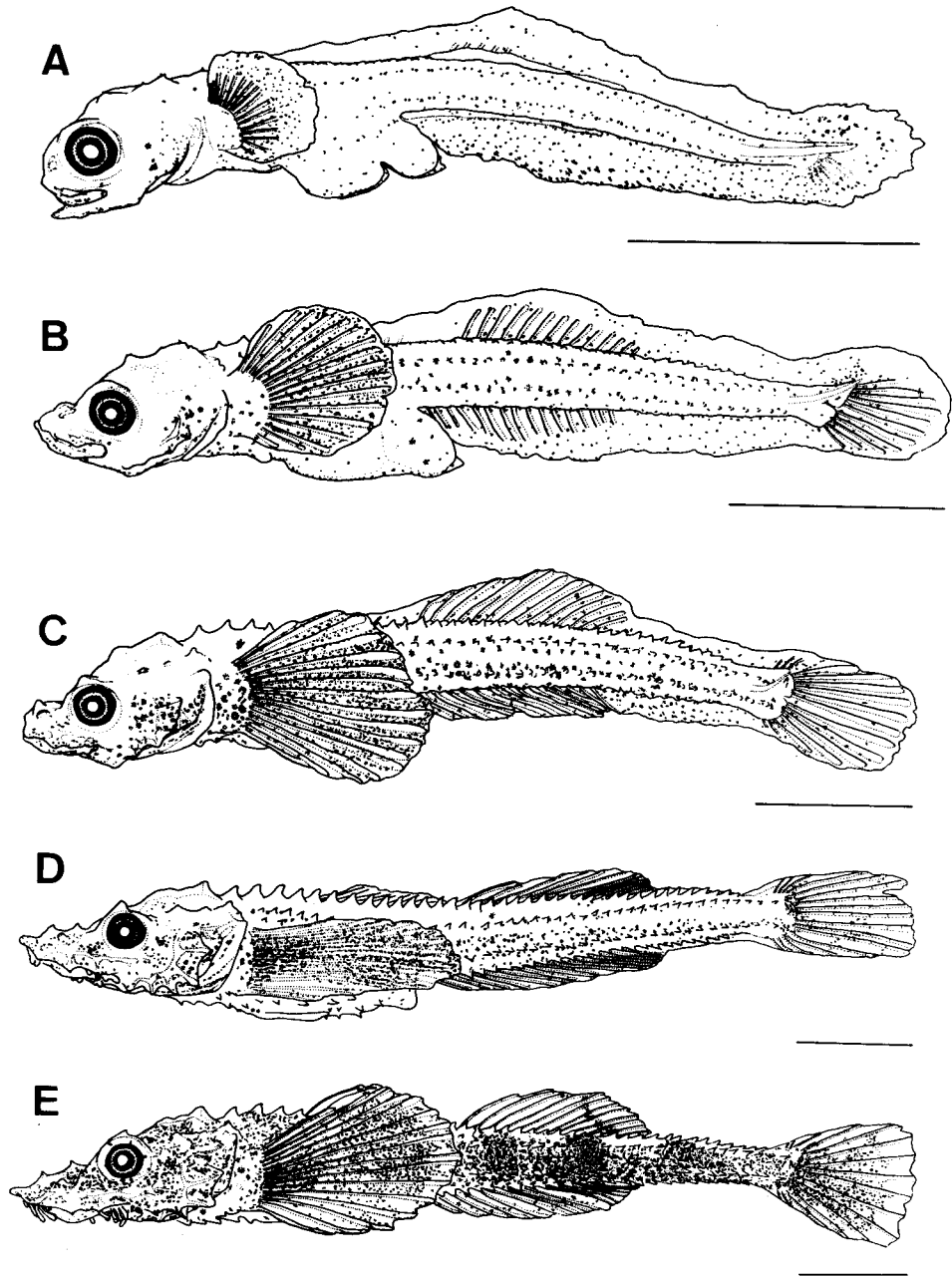

Fig. 18. Developmental series of *Podotheucus sachi*. A, 8.3 mm larva ; B, 11.2 mm larva ; C, 14.3 mm larva ; D, 19.6 mm larva ; E, 21.0 mm juvenile. Each scale indicates 3 mm.

appears at 10.9-12.1 mm and fuses at 14.3 mm ; two additional pairs of postocular spines (anterior and posterior) appear anterior to posttemporal spines at 12.1 mm ; anterior pair fuses at 14.3 mm and posterior pair fuses at 14.5-15.6 mm ; posttemporal spine and postocular spines fuse to form ridge for canal in late larval period ; another small spine appears just behind posttemporal spine at 18.7 mm ; each branchiostegal ray lacks process near proximal tip (Fig. 30G).

Full complements of bony plates appear in DLR at 11.2 mm, in MDR at 17.8-18.3 mm, in SLR at 13.1 mm, in ILR at 11.2 mm, in VLR and 12.1 mm and in MVR at 18.3 mm ; LLP not completed at its posterior part in largest specimen examined ; row of bony plates (upper row of ALLP) formed anterior to SLR in flexion phase ; lower row of ALLP appears below upper row of ALLP to form double row in late larval period, and extends to origin of SLR ; after completion of lower row of ALLP, PLLP formed as double row below anterior part of SLR, which gradually extends posteriorly ; no bony plates on gill membranes and gular region during development ; single row of bony plates formed between ventral midline of abdomen and VLR ; bony plates of anterior part of VLR remain spiny in juveniles ; all bony plates form initially as spines and later ossify basally to form bony plates of adults.

Full complements of fin spines and rays appear in first dorsal fin at 10.8-10.9 mm, in second dorsal and anal fins at 10.8 mm and in pelvic fin at 16.6 mm ; adult complement of pectoral fin rays present in smallest specimen examined ; median finfold gradually degenerates and no longer visible at 19.4-20.6 mm ; early larvae have small preanal finfold, which disappears at 16.6-17.7 mm ; dorsal and anal fins do not migrate during larval and juvenile periods ; first dorsal fin starts over middle of 3rd-4th to middle of 4th-5th DLR and ends over middle of 10th-11th to middle of 12th-13th ; second dorsal fin starts over 14th to middle of 15th-16th DLR and ends over 25th to middle of 27th-28th ; anal fin starts under 9th to middle of 10th-11th VLR and ends under middle of 22nd-23rd to middle of 25th-26th ; pectoral fin length increases from 8.2-14.7% SL in flexion larvae to 21.4-26.1% of SL in juveniles ; posterior end of pectoral fin reaches level of anus at 13.4-14.3 mm ; pectoral fin rounded in early larval period and gradually becomes fan-shaped ; barbels increase from one pair at 15.6 mm to eight pairs at 21.8 mm under tip of snout, from two at 14.3 mm to eight at 21.8 mm on posterior end of upper jaw and from one at 13.4 mm to two at 17.8 mm on lateral side of lower jaw.

### 3) Pigmentation

Irregular melanophore row extends along SLR and ILR ; supralateral melanophore row originates at level of pectoral fin base and infralateral row originates at middle between pectoral fin base and level of anus ; both rows terminate at hypural region ; a few melanophores present between ILR and anal fin base ; melanophores added to lateral surface of body to form five vertical bands in juvenile period ( $\geq 20.6$  mm SL) ; no melanophores present on gut region posterior to pectoral fin base ; melanophores present on lateral side of snout throughout development ; no melanophores present on tip of snout throughout larval period ; a few melanophores appear on hindbrain at 8.3-10.9 mm ; in early larval period, melanophores on midbrain present or absent, but no melanophores on forebrain ; in late larval period ( $\geq 17.7$

mm SL), small melanophores start to appear on surface of forebrain region; melanophores on gill membranes regularly arranged along each branchiostegal ray throughout development (Fig. 30G), but sometimes absent on first and second branchiostegal rays; row of melanophores lies along ventral midline of abdomen (Fig. 30G), and extends from isthmus to anus in early period and from pelvic fin base to anus in late larval period.

Many melanophores scattered on dorsal and anal finfolds except for first dorsal finfold; melanophores distributed moderately on caudal fin from base to posterior end; median finfold unpigmented until late larval period; a few melanophores appear on first dorsal fin at 18.3-18.7 mm, and oblique band formed on posterior half of second dorsal fin at 19.4 mm; additional melanophores gradually appear on basal and middle areas of caudal fin; these pigmented areas become continuous in larger juveniles; smallest preflexion larva examined already has melanophores on pectoral fin; as melanophores added on pectoral fin, its upper and lower parts gradually become paler resulting in heavily pigmented blotches on basal and posterior parts in early juveniles; these blotches connected in larger juveniles.

*Podothecus gilberti* (Collett)

Japanese name: Kôri-tokubire (Fig. 19, Table 15)

1) Specimens examined

Number of specimens, length of specimens and their developmental stages are shown in Table 15.

2) Morphology

Meristic counts are shown in Table 15.

Body slender, its depth 6.9 to 9.0% of SL throughout larval and juvenile periods; snout to anus length increases from 48.5-50.0% of SL in preflexion phase to 51.3-55.6% of SL in early postflexion phase and decreases to 48.8-49.8% of SL in late postflexion phase; head length increases from 20.0-21.5% of SL in preflexion phase to 27.9-31.5% of SL in postflexion phase; snout length increases from 25.6-26.1% of HL in preflexion phase to 41.8-43.3% of HL in late postflexion phase (21.3-23.8 mm SL); tip of snout blunt in early larval period, and becomes pointed rapidly in late larval period (about 17 mm SL); eye diameter decreases proportionally from 25.0% of HL in smallest specimen examined (10.0 mm SL) to 14.9% of HL in largest (23.8 mm SL); profile of abdomen constricted into two parts, flattens in juvenile period; gill membranes joined to isthmus; nostril divided into two at 14.4 mm; notochord flexion starts at 10.9 mm and completes at 12.2 mm.

Nasal spine first recognized at 12.2 mm, and obvious at 14.4 mm; ethmoid spine starts to form posterior to nasal spine at 12.2 mm; supraocular ridge with one spine appears at 12.2 mm; another spine appears on mesial side of posterior part of supraocular ridge at 20.8 mm; upper edge of fronto-parietal ridge with two to nine spinules concave at middle in flexion larvae; fronto-parietal spinules disappear at 12.2 mm; preopercular spines increase in number and size to form two rows (anterior and posterior) at 10.0-12.2 mm; each row composed of four spines; each spine of anterior row gradually extends over each spine of posterior row to form ridge for

Table 15. Development of meristic structures in *Podothecus gilberti*.

Spec. No.	SL (mm)	Developmental stage	Dorsal fin		Anal fin rays	Pectoral fin rays	Pelvic fin rays	Bony plates				
			spines	rays				DLR+MDR	SLR	ILR	VLR+MVR	LLP
1101	10.0	Preflexion	0	8	9	16	Buds	3	29**	26	7	?
1102	10.1	Preflexion	0	6	7	16	Buds	3	31**	31	8	?
1103	10.7	Preflexion	0	8	10	16	Buds	31	35**	32	9	?
1104	10.9	Flexion	0	8	10	16	Buds	30	31**	31	9	?
1105	12.2	Postflexion	8	9	10	16	Buds	33	33**	33	27	?
1106	14.4	Postflexion	9	9	10	16	I, 2	32	37**	35	28	?
1107	14.5	Postflexion	8	8	10	17	I, 2	33	35**	34	31	?
1108	15.6	Postflexion	8	8	11	16	I, 2	33	35**	35	31	?
1109	17.1	Postflexion	8	8	9	15	I, 2	32	37**	35	31	?
1110	18.8	Postflexion	8	8	9	16	I, 2	33	36**	34	30	?
1111	19.2	Postflexion	8	8	10	16	I, 2	34	28	36	32	7+ 6***
1112	19.8	Postflexion	8	8	10	16	I, 2	36	31	35	35	6+17***
1113	20.8	Postflexion	8	8	10	16	I, 2	32	29	34	31	7+16***
1114	21.3	Postflexion	8	9	10	17, 16*	I, 2	36	30	35	34	7+24***
1115	22.1	Postflexion	8	8	9	16	I, 2	35	31	36	35	7+23***
1116	23.8	Postflexion	8	8	10	16	I, 2	36	29	36	34	8+19***

\* Right side.

\*\* The number includes LLP, because the anterior part of LLP cannot be distinguished from SLR.

\*\*\* ALLP+PLLP.

canal during postflexion phase ; a pair of posttemporal spines appears at 12.1 mm and fuses at 14.4 mm ; two additional pairs of postocular spines (anterior and posterior) appear anterior to posttemporal spines at 12.2 mm ; anterior pair fuses at 12.2 mm and posterior fuses at 17.1 mm ; posttemporal spine and postocular spines fuse in late larval period ; another small spine appears just behind posttemporal spine at 14.4 mm ; each branchiostegal ray lacks process near proximal tip.

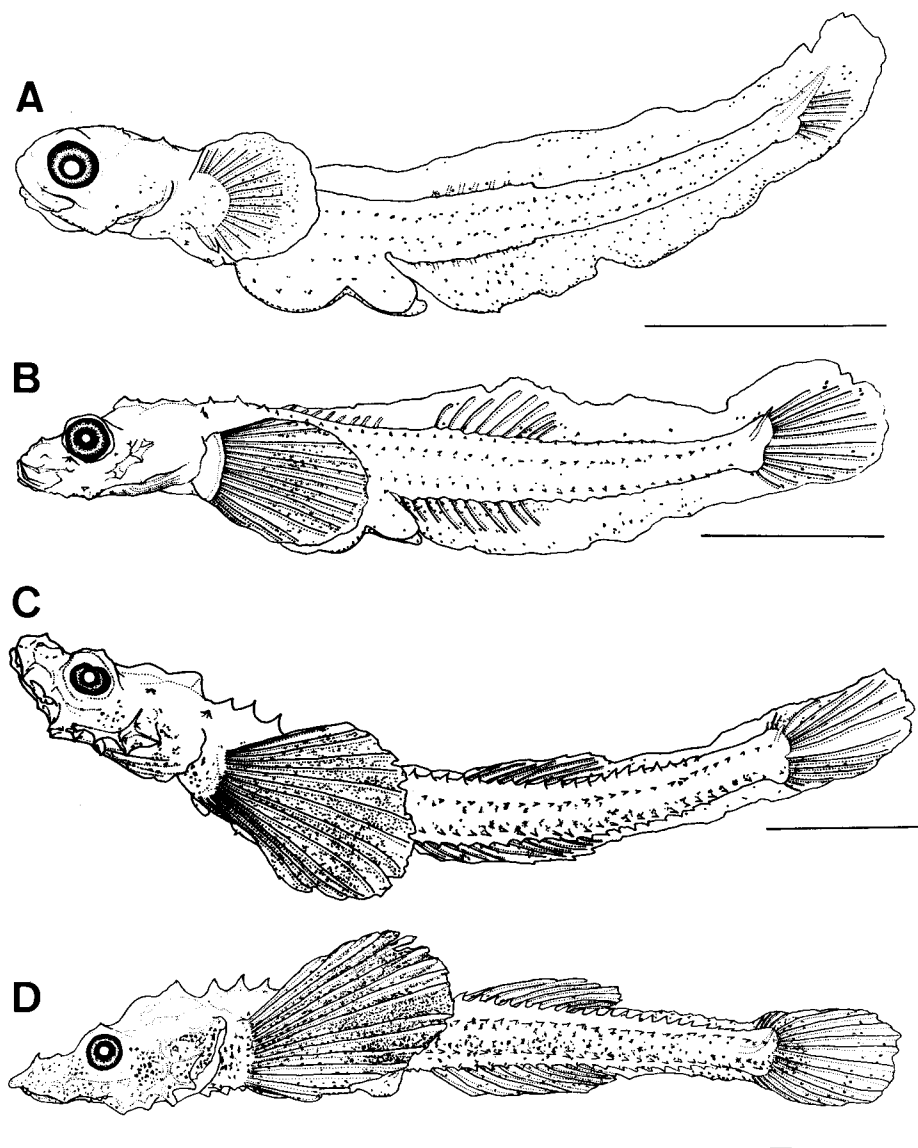

Fig. 19. Larvae of *Podothecus gilberti*. A, 10.1 mm ; B, 12.2 mm ; C, 14.5 mm ; D, 18.8 mm. Each scale indicates 3 mm.

Full complements of bony plates appear in DLR at 10.7 mm, in MDR at 19.8-21.3 mm, in SLR and ILR at 14.4 mm, in VLR at 12.2 mm and in MVR at 19.8-21.3 mm; LLP not completed posteriorly in largest specimen examined; row of bony plates (upper row of ALLP) formed anterior to SLR in flexion phase; lower row of ALLP appears below of upper row of ALLP to form double row in late larval period, and extends to origin of SLR; after completion of lower row of ALLP, PLLP formed as double row below anterior part of SLR, which gradually extends backward; no bony plates on gill membranes; bony plates between ventral midline of abdomen and VLR form single row (Fig. 25A); bony plates of anterior part of VLR remain spiny in largest specimen; all bony plates form initially as spines and later ossify basally to form bony plates of adults.

Full complements of anal and dorsal fin rays appear by about 12.0 mm; adult complements of pectoral fin rays already acquired in smallest specimen (10.0 mm SL); median finfold gradually degenerates with development; dorsal finfold between first and second dorsal fins no longer visible at 20.8 mm; dorsal finfold between second dorsal and caudal fins and anal finfold between anal and caudal fins persists as rudiment in largest specimen (23.8 mm); early larvae have small preanal finfold, which disappears at 14.5 mm; dorsal and anal fins do not migrate during larval and juvenile periods; first dorsal fin starts over middle of 4th-5th to middle of 5th-6th DLR and ends over middle of 10th-11th to 11th; second dorsal fin starts over 14th to middle of 15th-16th DLR and ends over middle of 20th-21st to middle of 21st-22nd; anal fin starts under middle of 9th-10th to middle of 11th-12th VLR and ends under middle of 18th-19th to middle of 20th-21st; pectoral fin length increases from 11.9% of SL to 26.1% of SL; posterior end of pectoral fin reaches level of anus at 12.2 mm; pectoral fin rounded in early larval period and gradually becomes fan-shaped; barbels increase from three pairs at 17.1 mm to six pairs at 21.3 mm under tip of snout, from three at 14.4 mm to eight at 22.1 mm on posterior end of upper jaw, and from one at 14.4 mm to two at 17.8 mm on lateral side of lower jaw.

### 3) Pigmentation

Irregular melanophore row extends along SLR and ILR; both rows originate at constricted portion of abdomen and terminate at hypural region; a few melanophores appear on VLR at 12.2 mm and increase in number to form row of melanophores at 14.4 mm; in postflexion phase, number of melanophores increases in ILR and above it; additional melanophores appear above base of pectoral fin; pigmented area extends backward to connect with infralateral melanophore row; no melanophores present on gut region posterior to base of pectoral fin; melanophores appear on tip and lateral side of snout at 14.4 mm; melanophores on gill membranes regularly arranged along each branchiostegal ray throughout development, but sometimes absent on first and second branchiostegal rays; row of melanophores lies along ventral midline of abdomen, extending from isthmus to anus in early larval period and from base of pelvic fin to anus in late larval period; a few melanophores appear on midbrain at 14.4 mm and on hindbrain at 10.9 mm; in late larval period ( $\geq 19.2$  mm SL), small melanophores start to appear on forebrain.

Many melanophores scattered on dorsal and anal finfolds except for first dorsal finfold; melanophores distributed on caudal fin from base to posterior end; no

Table 16. Development of meristic structures in *Podothecus thompsoni*.

Spec. No.	SL (mm)	Developmental stage	Dorsal fin		Anal fin rays	Pectoral fin rays	Pelvic fin rays	Bony plates				
			spines	rays				DLR+MDR	SLR	ILR	VLR+MVR	LLP
1201	10.1	Flexion	8	6	6	16	Buds	3	33**	32	7	?
1202	10.6	Flexion	9	6	7	16	Buds	32	33**	32	2	?
1203	10.9	Postflexion	9	6	6	16	Buds	36	35**	35	29	?
1204	12.0	Postflexion	8	6	7	16	2	37	37**	35	30	?
105	12.3	Postflexion	10	6	7	17, 16*	2	37	36**	35	34	?
1206	12.8	Postflexion	8	5	7	17	2	36	36**	34	34	?
1107	13.0	Postflexion	9	6	6	16	3	38	37**	35	34	?
1208	14.0	Postflexion	10	5	6	17	3	37	35**	37	34	?

\* Right side.

\*\* The number includes LLP, because the anterior part of LLP cannot be distinguished from SLR.

additional melanophores appear on median finfold until late larval period; a few melanophores appear on anterior part of first dorsal fin at 21.3 mm, and oblique band formed on posterior half of second dorsal fin at 23.8 mm; melanophores added to basal and middle areas of caudal fin with development; smallest specimen has melanophores on pectoral finfold; as melanophores added on pectoral fin, upper and lower parts become gradually paler resulting in two heavily pigmented blotches, which become connected in larger juveniles.

***Podothecus thompsoni* Jordan and Gilbert**  
Japanese name: Yase-tokubire (Fig. 20, Table 16)

1) Specimens examined

Number of specimens, length of specimens and their developmental stages are shown in Table 16.

2) Morphology

Meristic counts are shown in Table 16.

Body slender, its depth 7.1 to 10.1% of SL; snout to anus length 51.4 to 59.6% of SL; head length 24.8 to 28.5% of SL; snout to anus length 51.4 to 59.6% of SL; snout length increases from 24.0 to 33.3% of HL; tip of snout blunt throughout development; eye diameter decreases proportionally from 20.0% of HL in smallest specimen examined (10.1 mm SL) to 16.7% of HL in largest (14.0 mm SL); profile of abdomen constricted into two parts; gill membranes joined to isthmus; nostril divided into two at 12.0 mm; notochord already flexed in smallest specimen; notochord flexion completed at 10.9 mm.

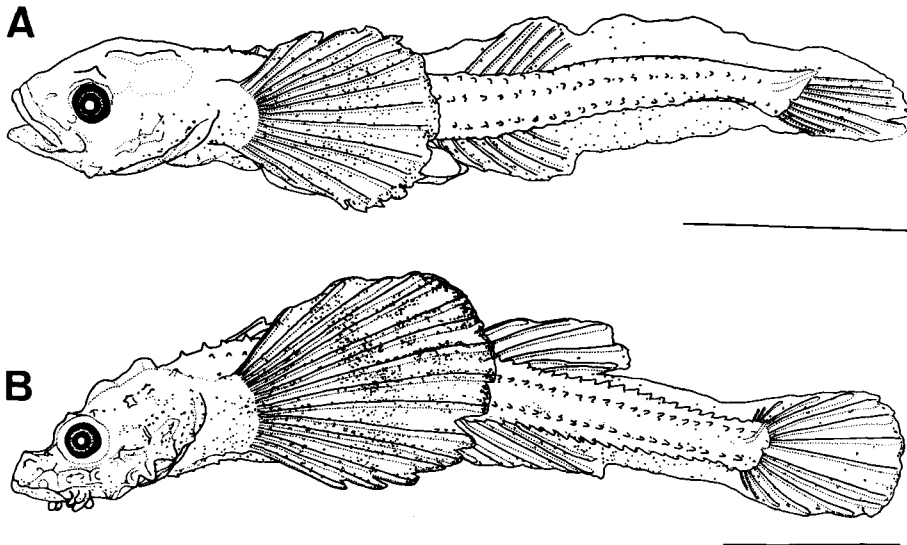

Fig. 20. Larvae of *Podothecus thompsoni*. A, 10.6 mm; B, 13.0 mm. Each scale indicates 3 mm.

Nasal spine appears at 10.9 mm; supraocular spine appears at 10.6 mm and another spine added posterior to it at 10.9 mm; upper edge of fronto-parietal ridge with 1-3 spinules has two or three concavities in flexion larvae; fronto-parietal spinules disappear at 12.0 mm; anterior and posterior rows of prepercular spines increase in number and size during flexion phase; each row composed of four spines; each spine of anterior row gradually extends over each spine of posterior row to form ridge for canal during postflexion phase; a pair of posttemporal spines appears at about 10.6 mm and fuses at 12.0 mm; another small spine appears just behind it at 12.0 mm; two additional pairs of postocular spines (anterior and posterior) appear anterior to posttemporal spines at 10.9 mm; anterior pair fuses at 12.0 mm and posterior pair fuses at 13.0 mm; each branchiostegal ray lacks process near proximal tip.

Full complements of bony plates appear in DLR at 10.6 mm, in MDR at 12.0 mm, in SLR and ILR at 12.0 mm, in VLR at 10.9 mm and in MVR at 12.3 mm; a few bony plates on gill membranes and gular region in postflexion phase; two rows of bony plates formed between ventral midline of abdomen and VLR; bony plates of anterior part of VLR remain spiny in largest specimen examined.

Full complements of dorsal, anal and pectoral fin rays already acquired in smallest specimen examined (10.1 mm SL); median finfold and preanal finfold persist in largest specimen examined (14.0 mm SL); dorsal and anal fins do not migrate during larval period; first dorsal fin starts over middle of 3rd-4th DLR and ends over middle of 10th-11th to middle of 12th-13th; second dorsal fin starts over middle of 16th-17th to middle of 18th-19th DLR and ends over 16th to middle of 19th-20th; anal fin starts under 11th to middle of 13th-14th VLR and ends under 16th to middle of 19th-20th; pectoral fin large, its length 17.8 to 32.3% of SL; posterior end of pectoral fin reaches level of anus at 12.0 mm; two pairs of barbels appear under tip of snout at 10.9 mm, and do not increase in number throughout development; barbels increase from five pairs at 10.9 mm to eight pairs at 12.0 mm on posterior end of upper lip, and from one at 10.6 mm to two at 12.0 mm on lateral side of lower lip.

### 3) Pigmentation

Irregular melanophore row extends along SLR, ILR and VLR; supralateral melanophore row along SLR usually originates at middle between pectoral fin base and anus, but sometimes extends above pectoral fin base; infralateral row along ILR originates at middle between pectoral fin base and level of anus; both rows terminate on hypural region; a few melanophores present between ILR and anal fin base; some melanophores on lateral side of snout; melanophores on gill membranes regularly arranged along each branchiostegal ray throughout development, sometimes absent on first and second branchiostegal rays; row of melanophores lies along ventral midline of abdomen extending from isthmus to anus in early larval period and from pelvic fin base to anus in late larval period; forebrain unpigmented, but one specimen (12.8 mm SL) has three faint melanophores; a few melanophores appear on lateral side of mid- and hindbrain at 10.6-10.9 mm.

Dorsal finfold pigmented except for part anterior to second dorsal fin; many melanophores scattered on anal finfold; caudal fin pigmented from base to posterior

Table 17. Development of meristic structures in *Podothecus* sp.

Spec. No.	SL (mm)	Developmental stage	Dorsal fin		Anal fin rays	Pectoral fin rays	Pelvic fin rays	Bony plates				
			spines	rays				DLR+MDR	SLR	ILR	VLR+MVR	LLP
1301	10.6	Preflexion	0	8	9	15	Buds	2	33**	26	2	?
1302	11.8	Flexion	8	7	10	15	Buds	32	34**	35	20	?
1303	11.8	Flexion	9	9	10	15	Buds	33	37**	37	33	?
1304	12.4	Flexion	9	8	10	15	Buds	33	36**	36	31	?
1305	12.5	Flexion	8	7	10	16	Buds	34	35**	36	32	?
1306	12.7	Flexion	9	8	10	15	Buds	35	37**	35	30	?
1307	13.1	Flexion	8	7	9	15	Buds	31	35**	36	33	?
1308	13.7	Postflexion	8	8	9	15	3	32	37**	37	35	?
1309	14.2	Postflexion	9	8	10	15	3	35	36**	37	34	?
1310	15.1	Postflexion	9	8	11	16	I, 2	35	37**	37	34	?
1311	15.1	Postflexion	9	7	10	16, 15*	I, 2	36	37**	36	33	?
1312	15.8	Postflexion	8	8	9	15	I, 2	35	39**	37	31	?
1313	16.1	Postflexion	8	8	9	15	I, 2	39	40**	38	34	?
1314	16.3	Postflexion	9	8	9	15	I, 2	37	38**	36	35	?
1315	16.5	Postflexion	8	7	10	16	I, 2	38	38**	37	35	?
1316	17.0	Postflexion	8	7	10	16	I, 2	38	33	37	37	6+7***
1317	17.2	Postflexion	9	7	10	15	I, 2	38	33	37	35	5+2***

\* Right side.

\*\* The number includes LLP, because the anterior part of LLP cannot be distinguished from SLR.

\*\*\* ALLP+PLL.

end; no additional melanophores appear on median finfold with development; pectoral fin has three indistinct bands, its posterior margin heavily pigmented with many small melanophores.

***Podothecus* sp.**

(Fig. 21, Table 17)

1) Specimens examined

Number of specimens, length of specimens and their developmental stages are shown in Table 17.

2) Morphology

Meristic counts are shown in Table 17.

Body slender, its depth 4.7 to 9.3% SL in larval period; snout to anus length increases from 50.9% of SL in smallest specimen examined to 56.3% of SL in early postflexion larva (15.1 mm SL), and decreases proportionally to 48.8% of SL in late postflexion larva (17.2 mm SL); head length increases proportionally from 20.8% of SL in preflexion phase to 25.4-29.9% of SL in flexion phase, does not change markedly in postflexion phase; snout length increases from 22.7 to 33.3% of HL; tip of snout blunt throughout development; eye diameter decreases proportionally from 29.3 to 18.4% of HL; profile of abdomen constricted into two parts at least to 17.2 mm; gill membranes joined to isthmus; nostril separates into two at 13.7 mm; notochord flexion starts at 11.8 mm and completes at 13.7 mm.

Nasal spine first recognized at 11.8 mm and obvious at 12.7 mm; supraocular spine appears at 11.8 mm and another spine added posteriorly to it at 12.5 mm; upper edge of fronto-parietal ridge with seven spinules concave at its middle in smallest specimen (10.6 mm SL); fronto-parietal spinules disappear at 11.8 mm; preopercular spines increase in number and size between 11.8-12.4 mm to form two rows (anterior and posterior); each row composed of four spines; each spine of anterior row gradually extends over each spine of posterior row to form ridge for canal during postflexion phase; a pair of posttemporal spines appears at 11.8 mm and fuses at 12.7 mm; another small spine appears just behind it at 15.1 mm; two additional pairs of postocular spines (anterior and posterior) appear anterior to posttemporal spines at 11.7-14.2 mm, and each fuses at 15.1-15.8 mm; each branchiostegal ray lacks process near proximal tip.

Full complements of bony plates appear in DLR at 11.8 mm, in MDR at 16.1 mm, in SLR and ILR at 11.8 mm, in VLR at 11.8 mm and MVR at 16.3-17.0 mm; LLP not completed posteriorly in largest specimen examined; row of bony plates (upper row of ALLP) formed anterior to SLR in flexion phase; lower row of ALLP appears below upper row of ALLP to form double row in late larval period, and extends to origin of SLR; after completion of lower row of ALLP, PLLP formed as double row below anterior part of SLR, which gradually extends backward; no bony plates on gill membranes and gular region; two rows of bony plates formed between ventral midline of abdomen and VLR; bony plates of anterior part of VLR remain spiny in late larval period; all bony plates form at first as spines and later ossify basally to change into bony plates of adults.

Full complements of rays appear in first and second dorsal fins at 11.8 mm, and

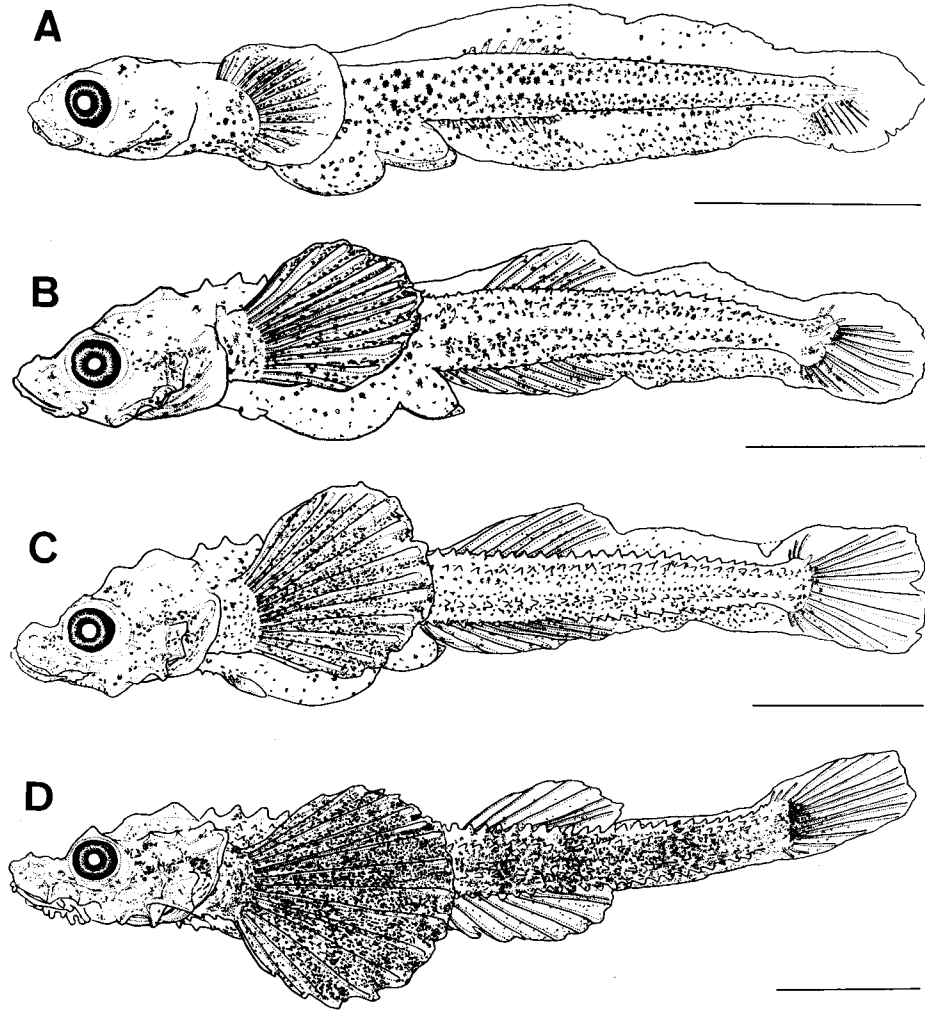

Fig. 21. Larvae of *Podotheucus* sp. A, 10.6 mm; B, 13.1 mm; C, 13.7 mm; D, 16.1 mm.  
Each scale indicates 3 mm.

already present in anal and pectoral fins in smallest specimen examined (10.6 mm SL); median finfold and preanal finfold persist in largest specimen (17.2 mm SL); dorsal and anal fins do not migrate during larval period; first dorsal fin starts over middle of 4th-5th DLR and ends over middle of 10th-11th to middle of 11th-12th; second dorsal fin starts over middle of 14th-15th to 16th DLR and ends over 20th to middle of 22nd-23rd; anal fin starts under middle of 9th-10th to middle of 11th-12th VLR and ends under middle of 18th-19th to middle of 20th-21st; pectoral fin length increases from 9.4 to 26.5% of SL; posterior end of pectoral fin reaches level of anus at 15.1 mm; pectoral fin rounded in early larval period and gradually becomes

fan-shaped; two pairs of barbels appear on tip of snout at 15.1 mm, and do not increase in number throughout development; barbels increase from 5 pairs at 15.1 mm to six pairs at 16.1 mm on posterior end of upper lip, from one at 13.1 mm to two at 15.1 mm on lateral side of lower lip.

### 3) Pigmentation

In early larval period, horizontal band runs along each lateral row of bony plates (SLR and ILR); both bands composed of four to five irregular melanophore rows, and extend from base of pectoral fin to hypural region; in preflexion phase, tip and lateral side of snout unpigmented; a few of melanophores appear on tip and lateral side of snout at 11.8 mm; melanophores on gill membranes regularly arranged along each branchiostegal ray throughout development, sometimes absent on first and second branchiostegal rays; row of melanophores lies along ventral midline of abdomen extending from isthmus to anus in early period and from pelvic fin base to anus in late larval period; preflexion larva already has two melanophores on forebrain; mid- and hindbrain wholly covered with melanophores; a few melanophores distributed on gular region.

Dorsal median finfold pigmented except for anterior to second dorsal fin; many melanophores scattered on anal median finfold; caudal fin pigmented at base, but unpigmented posteriorly; no additional melanophores appear on median finfold with development; in preflexion and early flexion phases, upper and lower parts of pectoral fin slightly paler, but uniformly pigmented in late postflexion phase.

### *Sarritor leptorhynchus* (Gilbert)

Japanese name: Tengutokubire (Fig. 22, Table 18)

#### 1) Specimens examined

Number of specimens, length of specimens and their developmental stages are shown in Table 18.

#### 2) Morphology

Meristic counts are shown in Table 18.

Body slender, its depth 6.3 to 9.4% of SL throughout larval period; snout to anus length 46.4 to 58.9% of SL; snout length increases from 13.3-24.4% of HL in preflexion phase to 27.0-31.9% of HL in postflexion phase; tip of snout blunt throughout development; eye diameter decreases proportionally from 40.0 to 16.7% of HL; profile of abdomen constricted into two parts in early larval period and gradually flatten in late larval period; gill membranes joined to isthmus; nostril separates into two at 13.6-14.9 mm; notochord flexion starts at 10.6 mm and completes at 14.5 mm.

Nasal spine first recognized at 13.6 mm and obvious at 14.5 mm; supraocular spine appears at 13.6 mm as another spine added posteriorly to it at 15.2 mm; upper edge of fronto-parietal ridge with four to six spinules concave; fronto-parietal spinules disappear at 12.7 mm; anterior and posterior rows of preopercular spines increase in number and size between 10.0 mm and 12.4 mm; each row composed of four spines; each spine of anterior row gradually extends over each spine of

Table 18. Development of meristic structures in *Sarritor leptorhynchus*.

Spec. No.	SL (mm)	Developmental stage	Dorsal fin		Anal fin rays	Pectoral fin rays	Pelvic fin rays	Bony plates				
			spines	rays				DLR+MDR	SLR	ILR	VLR+MVR	LLP
1401	8.0	Preflexion	0	0	0	0	Buds	0	19**	9	0	?
1402	8.4	Preflexion	0	0	0	0	Buds	3	31**	21	0	?
1403	9.8	Preflexion	1	5	6	15	Buds	4	29**	28	7	?
1404	10.0	Preflexion	2	6	7	14	Buds	28	34**	30	8	?
1405	10.4	Preflexion	7	6	6	14	Buds	8	31**	30	7	?
1406	10.6	Flexion	1	7	8	15	Buds	4	33**	35	9	?
1407	10.7	Flexion	1	6	7	14	Buds	4	34**	30	7	?
1408	10.9	Flexion	4	7	7	14, 15*	Buds	23	34**	31	9	?
1409	12.7	Flexion	9	7	7	14	Buds	37	36**	40	21	?
1410	13.6	Postflexion	7	6	6	14	Buds	37	36**	41	27	?
1411	14.1	Flexion	9	7	7	14	Buds	37	38**	39	35	?
1412	14.5	Postflexion	8	6	7	14	Buds	39	37**	39	28	?
1413	14.9	Postflexion	9	7	7	14	Buds	40	40**	40	36	?
1414	15.2	Postflexion	8	7	6	14	2	41	43**	41	38	?
1415	16.4	Postflexion	9	6	7	14	2	39	41**	40	37	?
1416	16.9	Postflexion	8	6	6	14	3	41	44**	42	40	?
1417	17.2	Postflexion	9	6	7	14	3	39	43**	42	37	?
1418	17.3	Postflexion	8	6	6	14	3	40	36	40	41	6+ 3***
1419	17.9	Postflexion	9	7	7	14	3	42	37	39	40	5+ 3***
1420	19.3	Postflexion	9	6	7	14	I, 2	39	36	40	39	6+11***
1421	19.6	Postflexion	9	6	7	15	I, 2	43	38	43	42	6+20***

\* Right side.

\*\* The number includes LLP, because the anterior part of LLP cannot be distinguished from SLR.

\*\*\* ALLP + PLLP.

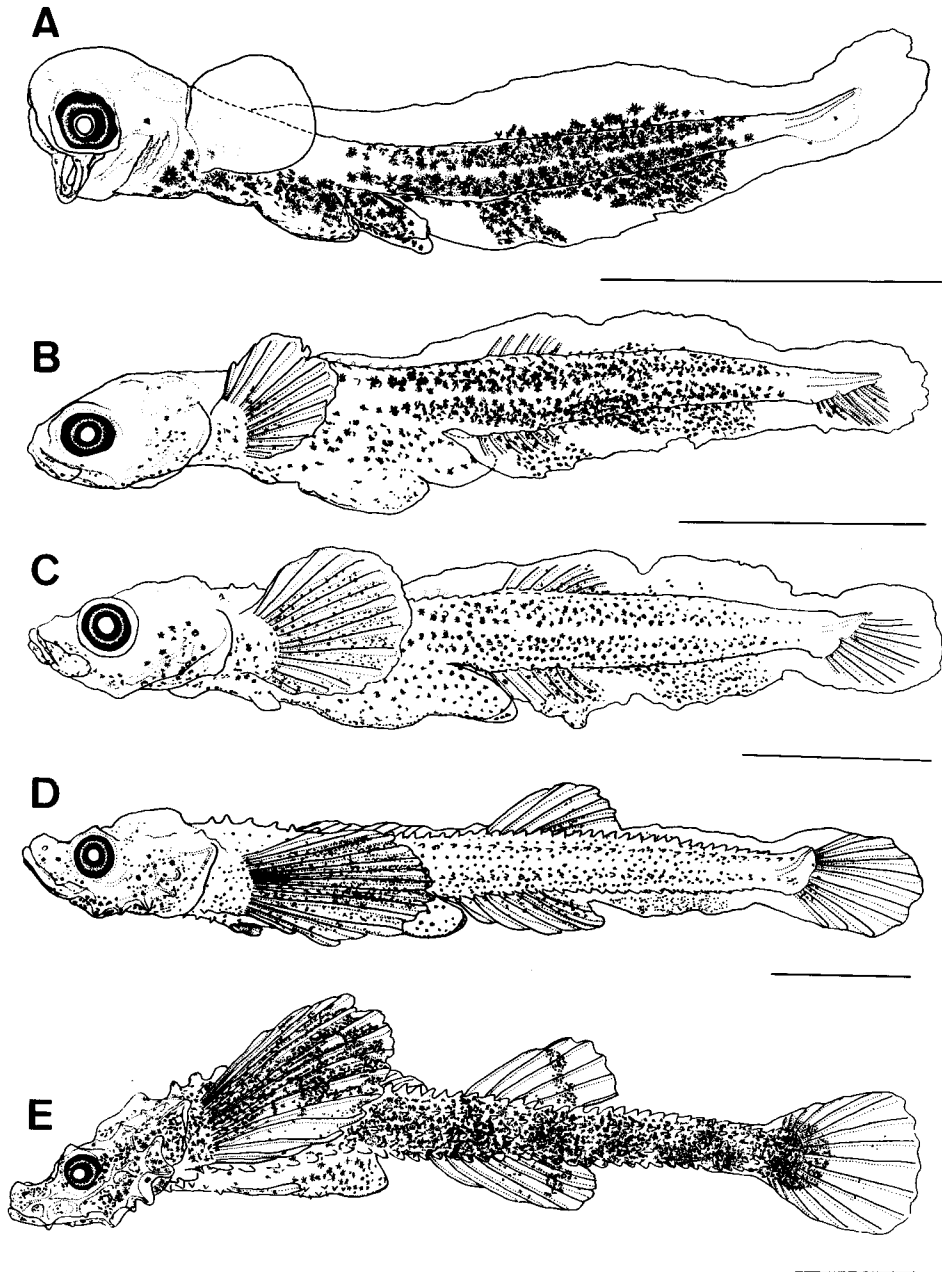

Fig. 22. Larvae of *Sarritor leptorhynchus*. A, 8.0 mm; B, 10.0 mm; C, 12.7 mm; D, 17.2 mm; E, 19.3 mm. Each scale indicates 3 mm.

posterior row to form ridge for canal during postflexion phase; a pair of posttemporal spines appears at 10.9 mm and fuses at 14.1-15.2 mm; another small spine appears just behind them at 13.6 mm; two additional pairs of postocular spines (anterior and posterior) appear anteriorly to posttemporal spines at 13.6 mm and each fuses at 16.9 mm; each branchiostegal ray lacks process near proximal tip.

Full complements of bony plates appear in DLR at 10.0 mm, in MDR at 16.9-17.3 mm, in SLR and ILR at 14.9 mm, in VLR at 10.6 mm and in MVR at 17.3 mm; LLP not completed posteriorly in largest specimen examined; row of bony plates (upper row of ALLP) formed anterior to SLR in flexion phase; lower row of ALLP appears below upper row of ALLP to form double row in late larval period, and extends to origin of SLR; after completion of lower row of ALLP, PLLP formed as double row below anterior part of SLR, which gradually extends backward; a few bony plates on gill membranes and gular region; two rows of bony plates formed between ventral midline of abdomen and VLR (Fig. 25B); bony plates of anterior part of VLR become spatular in shape in late larval period; all bony plates form initially as spines and later ossify basally to form bony plates of adults.

Full complements of fin spines and rays appear in first dorsal fin at 10.4-12.7 mm, in second dorsal fin at 10.0 mm, in pectoral fin at 9.8 mm, and in pelvic fin at 16.9 mm; median finfold gradually degenerates with development; dorsal median finfold between first and second dorsal fins disappears at 17.3-19.3 mm; dorsal median finfold between second dorsal and caudal fins and anal finfold between anal and caudal fins persist in largest specimen examined (19.6 mm SL); preanal finfold disappears at 17.3-19.3 mm; dorsal and anal fins do not migrate during larval period; first dorsal fin starts over fifth to middle of 5th-6th DLR and ends over middle of 12th-13th to middle of 14th-15th; second dorsal fin starts over middle of 16th-17th to middle of 18th-19th DLR and ends over middle of 21st-22nd to middle of 23rd-24th; anal fin starts under middle of 12th-13th to middle of 15th-16th VLR and ends under middle of 19th-20th to 23rd; pectoral fin length increases from 8.3 to 26.8% of SL; posterior end of pectoral fin reaches level of anus at 17.3 mm; pectoral fin rounded in early larval period and gradually becomes fan-shaped; three pairs of barbels appear on posterior end of upper lip at 19.3 mm; a pair of barbels appears on lateral side of lower lip at 19.3 mm.

### 3) Pigmentation

In early larval period, horizontal band runs along each lateral row of bony plates (SLR and ILR); each band composed of three to five irregular melanophore rows, extending from constricted portion of abdomen to anterior to caudal peduncle; origin of each band somewhat advanced in flexion phase; melanophores appear between supralateral and infralateral bands at 12.7 mm and connected them; snout unpigmented in preflexion larvae; a few melanophores appear on lateral side of snout at 13.6 mm and on tip at 16.7-17.2 mm; melanophores on gill membranes regularly arranged along each branchiostegal ray throughout development, but sometimes absent on first and second branchiostegal rays; row of melanophores lies along ventral midline of abdomen, extending from isthmus to anus in early larval phase and from pelvic fin base to anus in late larval phase; fore-, mid- and hindbrain unpigmented in smallest specimen examined; a few melanophores appear

on midbrain at 10.4–12.7 mm and on hindbrain at 8.4–12.7 mm; superficial region of forebrain becomes pigmented with many small melanophores at 17.3 mm.

Dorsal median finfold pigmented except for anterior to second dorsal fin and above caudal peduncle; many melanophores scattered on anal median finfold except for lower part posterior to anal fin and part below caudal peduncle, but one specimen (10.7 mm SL) entirely pigmented on lower part posterior to anal fin; caudal fin pigmented at base, but not posteriorly; no additional melanophores appear on median finfold with development; pectoral fin of early preflexion larvae unpigmented; melanophores appear on lower part of pectoral fin at 9.8 mm, and pigmented area gradually extends upward during late preflexion and flexion phases; as melanophores added on pectoral fin, upper and lower parts gradually become paler; largest specimen examined has a few unpigmented regions posteriorly.

***Bothragonus occidentalis* Lindberg**

Japanese name: Saitokubire (Fig. 23, Table 19)

1) Specimens examined

Number of specimens, length of specimens and their developmental stages are shown in Table 19.

2) Morphology

Meristic counts are shown in Table 19.

Body slender, its depth increases from 9.1–12.2% of SL in flexion phase to 14.0–15.5% of SL in juvenile period; snout to anus length decreases proportionally from 50.6–57.0% of SL in flexion phase to 40.1–41.4% of SL in juvenile period; head length increases from 20.8–26.0% of SL in flexion phase to 28.9–29.9% of SL in juvenile period; snout length increases from 18.8–25.5% of HL in flexion phase to 25.5–27.8% of HL in juvenile period; tip of snout blunt throughout development; eye diameter decreases proportionally from 26.9–37.5% of HL in flexion phase to 20.4–21.3% of HL in juvenile period; profile of abdomen not constricted throughout development; gill membranes joined to isthmus; nostril separates into two at 10.6 mm; notochord already flexed in smallest specimen examined (7.7 mm SL); notochord flexion completed at 10.6 mm.

Nasal spine appears at 10.6 mm; supraocular spine appears at 8.2 mm and another spine added posteriorly to it at 10.6 mm; upper edge of fronto-parietal ridge with five to six spinules irregularly serrated in flexion larvae and these fronto-parietal spinules disappear at 10.0 mm; anterior and posterior rows of preopercular spines increase in number and size during flexion phase; each row composed of four spines; each spine of anterior row gradually extends over each spine of posterior row to form ridge for canal during postflexion phase; a pair of posttemporal spines appears at 10.0 mm and fuses at 10.6 mm; another small spine appears just behind it at 11.1 mm; two additional pairs of postocular spines (anterior and posterior) appear anteriorly to posttemporal spines at 10.0–10.6 mm; both pairs fuse at 11.7 mm; each branchiostegal ray lacks process near proximal tip.

Full complements of bony plates appear in DLR at 10.6 mm, in MDR at 11.1 mm, in SLR at 11.7 mm, in ILR at 11.1 mm, in VLR at 10.6 mm and in MVR at 11.1

Table 19. Development of meristic structures in *Bothragonus occidentalis*.

Spec. No.	SL (mm)	Developmental stage	Dorsal fin		Anal fin rays	Pectoral fin rays	Pelvic fin rays	Bony plates				
			spines	rays				DLR+MDR	SLR	ILR	VLR+MVR	LLP
1501	7.7	Flexion	0	5	6	11	Buds	6	12	3	4	—
1502	8.2	Flexion	2	4	6	11	Buds	7	27	27	12	—
1503	9.2	Flexion	2	4	6	11	Buds	15	26	28	24	—
1504	9.5	Flexion	0	6	7	11	Buds	7	28	28	10	—
1505	10.0	Flexion	3	4	6	11	Buds	12	26	28	21	—
1506	10.6	Postflexion	3	6	7	11	3	29	30	32	32	—
1507	10.9	Postflexion	3	5	6	12, 11*	3	35	31	31	35	21
1508	11.1	Postflexion	2	5	6	11	I, 2	35	31	33	35	21
1509	11.7	Postflexion	4	5	6	11	I, 2	35	31	35	35	29
1510	12.0	Postflexion	3	5	6	11, 12*	I, 2	35	36	33	35	15
1511	12.3	Postflexion	2	5	6	11	I, 2	34	31	33	35	28
1512	12.5	Postflexion	3	4	4	11	I, 2	35	30	34	36	24
1513	12.8	Postflexion	2	4	5	11	I, 2	35	31	34	35	34
1514	15.7	Juvenile	2	4	6	11	I, 2	36	31	34	35	35
1515	18.7	Juvenile	2	4	5	12	I, 2	35	31	34	34	34

\* Right side.

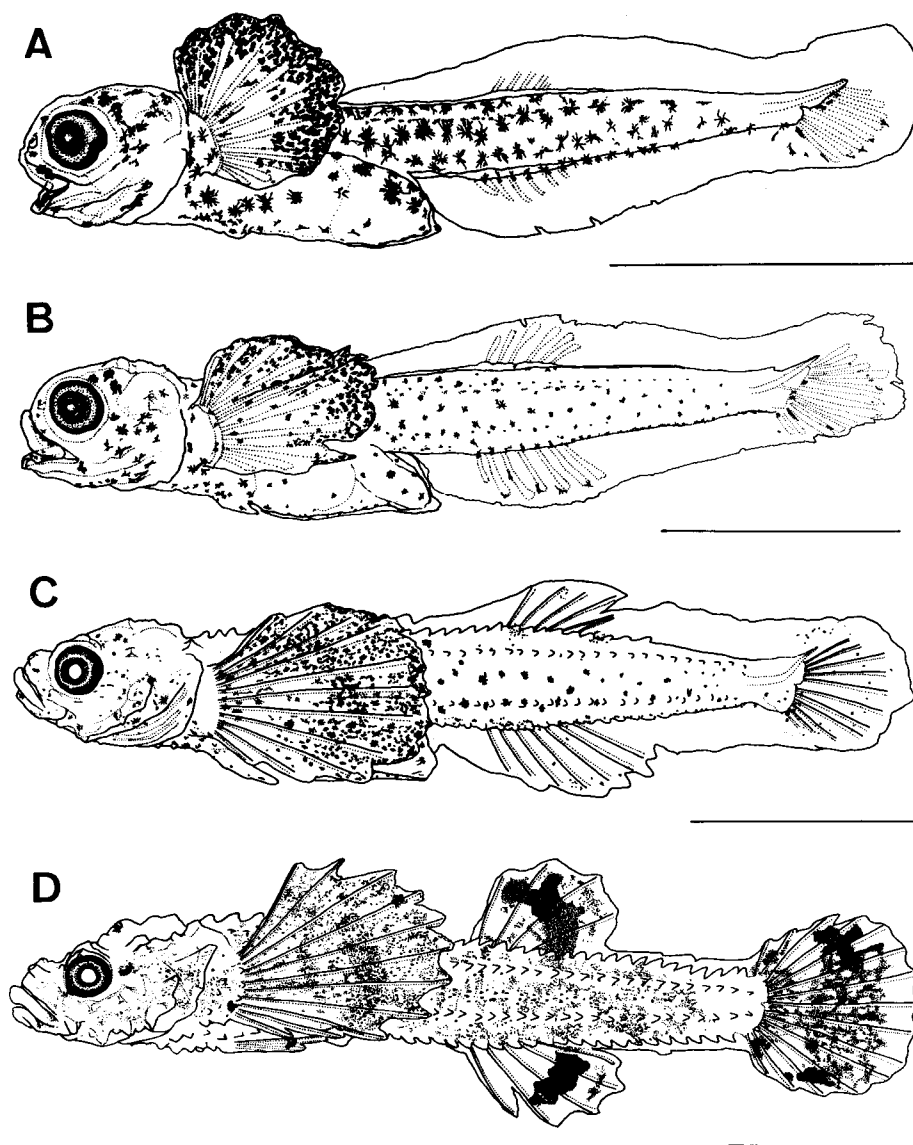

Fig. 23. Larvae of *Bothragonus occidentalis*. A, 7.7 mm; B, 9.5 mm; C, 10.6 mm; D, 12.8 mm. Each scale indicates 3 mm.

mm; LLP extends backwards as double row; several bony plates on gill membranes and gular region in postflexion phase; two or three rows of bony plates arranged between ventral midline of abdomen and VLR near anus; bony plates of anterior part of VLR remain spiny in juveniles; all bony plates form initially as spines and later ossify basally to form bony plates in adults.

Full complements of rays in second dorsal, anal and pectoral fins already acquired in smallest specimen examined (7.7 mm SL); full complements of first dorsal fin rays appear at 8.2-10.0 mm; dorsal median finfold between first and second dorsal fins disappears at 12.3-12.8 mm; dorsal median finfold between second dorsal and caudal fins, and anal median finfold between anal and caudal fins disappears at 15.7 mm; preanal finfold disappears at 12.3-12.8 mm; dorsal and anal fins do not migrate during larval period; first dorsal fin starts over eighth to ninth DLR and ends over middle of 9th-10th to 12th; second dorsal fin starts over middle of 17th-18th to middle of 20th-21st DLR and ends over middle of 20th-21st to 25th; anal fin starts under middle of 16th-17th to 20th VLR and ends under middle of 21st-22nd to 26th; pectoral fin large, its length 18.2-30.6% of SL; posterior end of pectoral fin reaches level of anus at 11.1 mm.

### 3) Pigmentation

Row of melanophores extends along DLR from lateral side of nape to origin of second dorsal fin; melanophores irregularly scattered on lateral side of body from origin of first dorsal fin to hypurals; in postflexion phase ( $\geq 11.7$  mm), six vertical indistinct bands begin to form on lateral surface of body; additionally numerous melanophores scattered over trunk except for part below middle of second dorsal fin; melanophores on gill membranes regularly arranged along each branchiostegal ray throughout development, sometimes absent on first and second branchiostegal rays; row of melanophores lies along ventral midline of abdomen, extending from isthmus to anus in early larval phase and from pelvic fin base to anus in late larval phase; snout pigmented throughout larval period; fore-, mid- and hindbrain already covered with melanophores in smallest specimen examined.

Dorsal median finfold unpigmented in flexion phase; early flexion larvae have row of melanophores on base of anal finfold, extending from origin of anal fin to caudal peduncle; melanophore row migrates to ventral margin of body; anal finfold becomes pigmented at 8.2 mm and second dorsal finfold at 10.6 mm; arch-shaped blotch formed on each finfold at 11.7 mm; caudal fin pigmented on base and end of caudal fin rays in early flexion phase; as melanophores added on middle part of caudal fin, large blotch with some unpigmented areas formed on fin in late postflexion phase; caudal fin wholly pigmented in juvenile period; pectoral fin has many large star-shaped melanophores on posterior margin in flexion phase; as melanophores added on pectoral fin, two heavily pigmented bands formed on its posterior half and blotch formed on its base; both bands connected on lower half of pectoral fin in juvenile period.

## Summary and comparison of Agoninae

### 1) Identification

The six developmental series of agonines are linked together by pigment patterns and meristic structures (fin rays and bony plates). All have the agonine character of gill membranes being joined to the isthmus (Matsubara, 1955), and can be identified by a combination of meristic structures that links adults and the developmental series (Table 20). *Podotheucus sachi* is unique in having more than 12

Table 20. Comparison of meristic counts between present larvae and juveniles, and

	Larvae and juveniles				
	<i>Podothecus sachi</i>	<i>Podothecus gilberti</i>	<i>Podothecus thompsoni</i>	<i>Podothecus</i> sp.	<i>Sarritor leptorhynchus</i>
First dorsal spines	8-9	8-9	8-10	7-9	7-9
Second dorsal rays	12-14	8-9	5-6	7-9	6-7
Anal fin rays	15-17	9-11	6-7	9-10	6-8
Pectoral fin rays	16-18	15-17	16-17	15-16	13-15
DLR+MDR	35-40	33-36	36-38	37-38	39-43
SLR	31-34	29-31	—*	33	36-38
ILR	38-39	34-36	34-35	36-38	39-43
VLR+MVR	36-38	34-35	34	35-37	39-42

\* Could not distinguish the anterior part of LLP from SLR.

rays on the second dorsal fin and more than 14 rays on the anal fin. *Podothecus gilberti* has eight to nine spines on the first dorsal fin, 9 to 11 rays on the anal fin and 29 to 31 bony plates on SLR. *Podothecus thompsoni* has 8 to 10 rays on the first dorsal fin ray, six to seven rays on anal fin and 34 to 35 bony plates on ILR. The fourth series could be *Podothecus hamlini*, *P. veterunus* and *Leptagonus decagonus* (Jordan and Evermann, 1898; Jordan and Starks, 1903; Matsubara, 1955). The series is distinguished from *L. decagonus* in having the barbels under the snout (lacking in the latter, Jordan and Evermann, 1898; Matsubara, 1955). There is, however, poor information about the meristic characters of *P. hamlini* and *P. veterunus*. Consequently, this series is described and discussed as *Podothecus* sp. *Sarritor leptorhynchus* is identified by having 13 to 15 rays on the pectoral fin and 36-38 bony plates on SLR. *Bothragonus occidentalis* is identified in having two to four spines on the first dorsal fin and 11 to 12 rays on the pectoral fin.

## 2) Comparison of other useful characters for identification

*Body depth.* — Larvae of *Bothragonus occidentalis* are somewhat deeper bodied than the other five species of Agoninae; body depth is more than 10% of SL, except for the smallest specimen (9.1% of SL), in *B. occidentalis*; body depth of the other species is less than 10% of SL throughout development.

*Pectoral fin length.* — Pectoral fin length is proportionally larger in the two species (Fig. 24), *Podothecus thompsoni* and *Bothragonus occidentalis*. In the postflexion phase, the pectoral fin length is 26.2-30.6% of SL in *P. thompsoni*, 26.2-32.3% of SL in *B. occidentalis*, 17.2-26.0% of SL in *P. sachi*, 23.0-26.2% of SL in *P. gilberti*, 21.1-26.5% of SL in *Podothecus* sp., and 20.1-26.8% of SL in *S. leptorhynchus*.

*Separation of nostril.* — Nostril separation occurs earlier in *Bothragonus occidentalis* (10.6 mm SL) and *Podothecus thompsoni* (12.0 mm SL) than in the other four species; *P. sachi* separated at 13.1 mm, *P. gilberti* at 14.4 mm, *Podothecus* sp. at 13.7 mm and *Sarritor leptorhynchus* at 13.6-14.9 mm.

*Bony plates on gill membranes and gular region.* — In the late postflexion phase

adults of six species of Agoninae in Japan. Adult's data are from Kanayama (1984).

Adults						
<i>Bothragonus occidentalis</i>	<i>Podothecus sachi</i>	<i>Podothecus gilberti</i>	<i>Podothecus thompsoni</i>	<i>Sarritor leptorhynchus</i>	<i>Sarritor frenatus</i>	<i>Bothragonus occidentalis</i>
2-4	8-10	7-9	8-10	6-9	6-8	2-4
4-6	12-14	7-9	5-7	6-8	6-8	4-5
5-7	13-17	8-11	6-8	6-8	6-7	6
11-12	16-19	15-17	15-17	13-15	15-16	11-12
34-36	37-42	33-40	35-39	37-45	40-47	35-37
31	29-33	28-31	30-32	35-42	41-43	32-33
33-35	37-40	34-36	33-36	39-43	41-45	34-35
34-35	35-42	33-38	32-36	34-44	37-46	35-37

and the juvenile period, agonine larvae are separable into two groups according to presence or absence of the bony plates on the gill membranes and the gular region. The first group consists of *Podothecus thompsoni*, *Sarritor leptorhynchus* and *Bothragonus occidentalis*. The larvae of this group have bony plates on the gill membranes and the gular region. The second group is composed of *Podothecus sachi*, *P. gilberti* and *Podothecus* sp. The larvae of this group lack the bony plates on the gill membranes and the gular region.

*Bony plates on abdomen.*— In the postflexion phase and juvenile period, agonine species fall into two groups according to the bony plates between ventral midline of abdomen and VLR. The first group comprises *Podothecus sachi* and *P. gilberti*. In this group, a single row of bony plates is formed between the ventral midline of the abdomen and VLR (Fig. 25A). The second group is composed of the other four species of Agoninae. In this group, two or three rows of bony plates are formed between the ventral midline of the abdomen and VLR (Fig. 25B).

*Development of barbels* (Table 21). — All species of Agoninae in Japan except for *Bothragonus occidentalis* have barbels under the snout, the posterior end of the upper lip and the lateral side of the lower lip; *Bothragonus occidentalis* lacks the barbels under the snout and on the lower lip (Jordan and Evermann 1898; Kanayama 1984). Barbels under the snout appear earlier in *P. thompsoni* (12.0 mm SL) than in *P. sachi*, *P. gilberti* and *Podothecus* sp. (15.1-17.1 mm SL), but do not appear yet in the largest specimen of *Sarritor leptorhynchus* examined (19.6 mm SL). Barbels on the posterior end of the upper lip appear earlier in *Bothragonus occidentalis* at 10.6 mm and *P. thompsoni* at 10.9 mm than in the other four species at 13.7-19.3 mm. Barbels on the lateral side of the lower lip appear earlier in *P. thompsoni* at 10.6 mm than in *P. sachi*, *P. gilberti*, *Podothecus* sp. and *S. leptorhynchus* at 13.1-19.3 mm.

*Lateral surface of body.*— In the flexion and early postflexion phases, *Podothecus sachi*, *P. gilberti* and *P. thompsoni* have two irregular melanophore rows; the supralateral row along SLR and the infralateral row along ILR (Fig. 26A-C). The supralateral row starts at the constricted portion of the abdomen in *P. gilberti* and

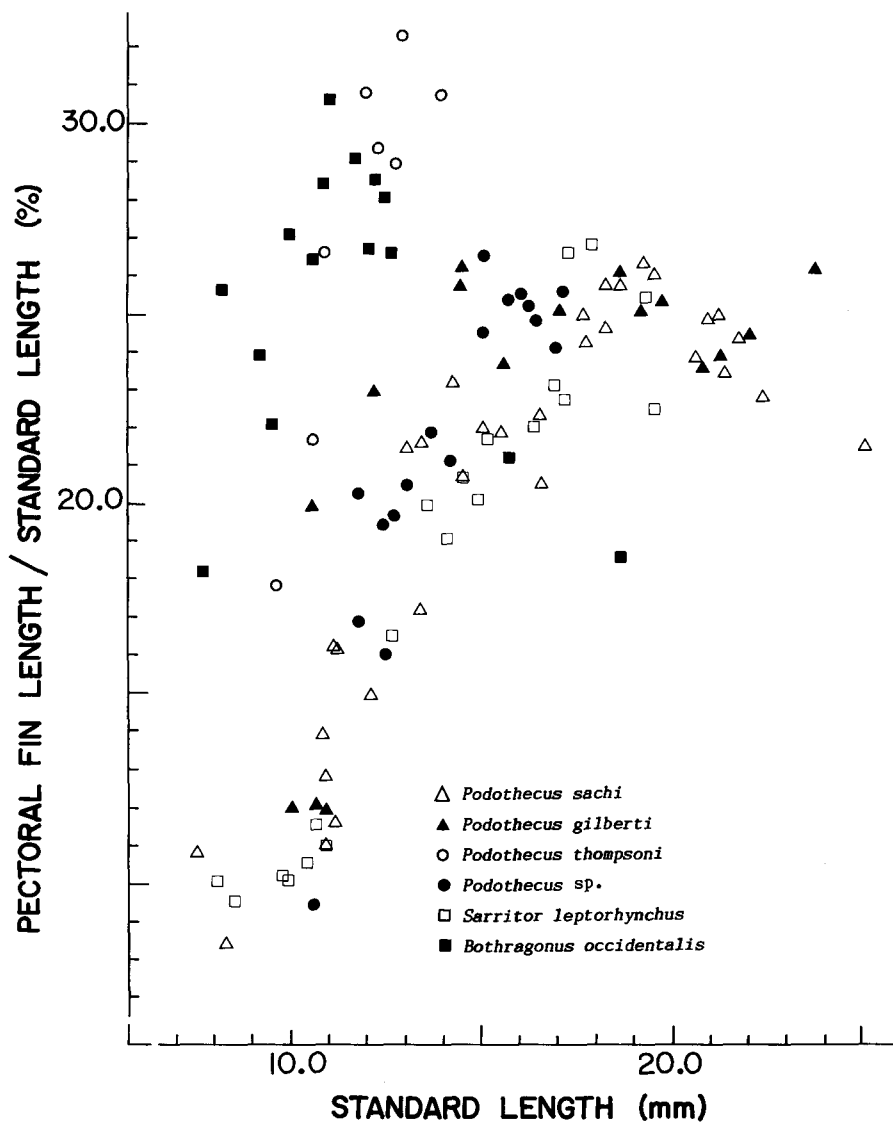

Fig. 24. Relationship between pectoral fin length-standard length ratio and standard length in six species of Agoninae.

in most larvae of *P. thompsoni* and above the pectoral fin base in *P. sachi* and some specimens of *P. thompsoni*. *Sarritor leptorhynchus* and *Podothecus sp.* have a double band, the supralateral band along SLR and the infralateral band along ILR (Fig. 26D, E). *Sarritor leptorhynchus* differs from *Podothecus sp.* in having an unpigmented area on the anterodorsal region of the body and the caudal peduncle. *Bothragonus occidentalis* has irregularly scattered melanophores on the body and a

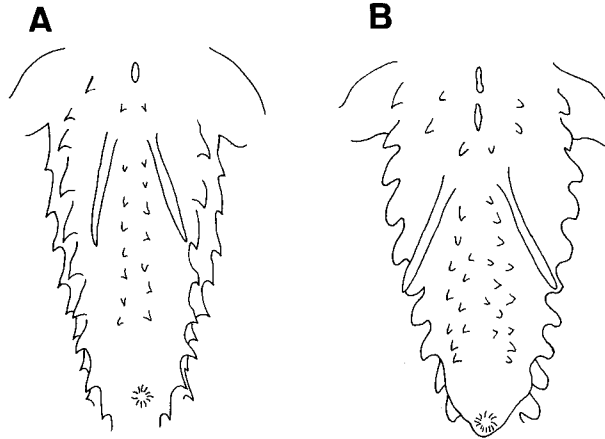

Fig. 25. Comparison of bony plates on ventral side of abdomen in *Podothecus gilberti* and *Sarritor leptorhynchus*. A, *Podothecus gilberti*, 19.2 mm; B, *Sarritor leptorhynchus*, 19.3 mm.

melanophore row extended from the lateral side of the nape to about the origin of the second dorsal fin (Fig. 26F).

*Caudal fin.*—Larvae of Agoninae fall into two groups according to the pigmented area of the caudal fin. The first group consists of *Podothecus sachi*, *P. gilberti*, *P. thompsoni* and *Bothragonus occidentalis*. In this group, the pigmented area extends to the posterior part of the caudal fin (Fig. 26A-C, F). The second group contains *Podothecus* sp. and *Sarritor leptorhynchus*. In this group, the pigmented area never extends to the posterior part of the caudal fin (Fig. 26D, E).

*Pectoral fin.*—Postflexion larvae and juveniles of Agoninae fall into three groups according to the pigment pattern of pectoral fin. The first group consists of *Podothecus sachi*, *P. gilberti*, and *Sarritor leptorhynchus*. In this group, the upper and lower parts of the pectoral fin are paler than the other region (Fig. 18, 19 and 22). The second group is composed of *P. thompsoni* and *Bothragonus occidentalis*. In this group, the pectoral fin has 3 indistinct bands (Figs. 20 and 23). The third group includes only one species, *Podothecus* sp. The pectoral fin is uniformly pigmented (Fig. 21).

*Forebrain.*—The smallest specimens of *Bothragonus occidentalis* (7.7 mm SL) and *Podothecus* sp. (10.6 mm SL) already have melanophores on the forebrain (Fig. 27A, B). While in *P. sachi* (Fig. 27C), *P. gilberti* and *Sarritor leptorhynchus*, the forebrain starts to be pigmented in the late postflexion phase (17.2–19.2 mm SL). *P. thompsoni* is usually unpigmented except for one specimen (12.8 mm SL) with three melanophores

### 3) Comparison with other agonine species

Washington *et al.* (1984) illustrated a larva of *Bothragonus swani* (6.3 mm SL) without description. Judging from their illustration, *Bothragonus occidentalis* in

Table 21. Development of number of barbels

SL (mm)	<i>Podothecus sachi</i>			<i>Podothecus gilberti</i>			<i>Podothecus thompsoni</i>		
	Snout	Upper lip	Lower lip	Snout	Upper lip	Lower lip	Snout	Upper lip	Lower lip
7- 8	—	—	—	—	—	—	—	—	—
8- 9	0	0	0	—	—	—	—	—	—
9-10	0	0	0	—	—	—	—	—	—
10-11	0	0	0	0	0	0	0	0-5	0-1
11-12	0	0	0	—	—	—	—	—	—
12-13	0	0	0	0	0	0	1-2	7-8	2
13-14	0	0	0-1	—	—	—	2	8	2
14-15	0	2	1	0	3	1	2	8	2
15-16	0-1	2-4	1	0	4	1	—	—	—
16-17	1	4	1	—	—	—	—	—	—
17-18	2	7	1-2	3	5	2	—	—	—
18-19	3-5	6-7	2	3	6	2	—	—	—
19-20	6-7	7	2	5	7	2	—	—	—
20-21	7	7	2	5	7	2	—	—	—
21-22	5-8	7-8	2	6	7	2	—	—	—
22-23	7	7	2	6	8	2	—	—	—
23-24	—	—	—	6	7	2	—	—	—
24-25	—	—	—	—	—	—	—	—	—
25-26	7	7	2	—	—	—	—	—	—

this study differs from *B. swani* as follows. (1) Notochord flexion is not completed until 10.6 mm in *B. occidentalis* (Table 13), but is already completed at 6.3 mm in *B. swani* (Washington *et al.* 1984, Fig. 232B). (2) *B. occidentalis* has neither spines nor ridges on the head in our smallest specimen (7.7 mm SL, Fig. 23A), while in *B. swani*, the nasal, supraocular, postocular, posttemporal and preopercular spines and supraocular and fronto-parietal ridges are well developed at 6.3 mm. (3) The pectoral fin has a heavily pigmented margin in *B. occidentalis* (Fig. 23A, B), but lacks such a heavily pigmented outer border in *B. swani*.

#### 4. Subfamily Aspidophoroidinae

##### *Aspidophoroides bartoni* Gilbert

Japanese name : Tatetokubire (Fig. 28, Table 22)

##### 1) Specimens examined

Number of specimens, length of specimens and their developmental stages are shown in Table 22.

in six species of Agoninae.

<i>Podotheucus</i> sp.			<i>Sarritor leptorhynchus</i>			<i>Bothragonus occidentalis</i>
Snout	Upper lip	Lower lip	Snout	Upper lip	Lower lip	Upper lip
—	—	—	—	—	—	0
—	—	—	0	0	0	0
—	—	—	0	0	0	0
0	0	0	0	0	0	0-1
0	0	0	—	—	—	1
0	0	0	0	0	0	1
0	0-3	1	0	0	0	—
0	3	1	0	0	0	—
2	5	2	0	0	0	2
2	6	2	0	0	0	—
2	6	2	0	0	0	—
—	—	—	—	—	—	2
—	—	—	0	3	1	—
—	—	—	—	—	—	—
—	—	—	—	—	—	—
—	—	—	—	—	—	—
—	—	—	—	—	—	—
—	—	—	—	—	—	—
—	—	—	—	—	—	—

## 2) Morphology

Meristic counts are shown in Table 22.

Body greatly elongate, its depth decreases proportionally from 3.8-5.5% of SL in preflexion phase to 3.3-4.0% of SL in postflexion phase; snout to anus length decreases proportionally from 40.4-45.2% of SL in preflexion phase to 33.3-40.1% of SL in postflexion phase; head length 13.3 to 17.8% of SL; snout length increases from 15.7-21.4% of HL in preflexion phase to 25.7-29.6% of HL in postflexion phase; eye diameter decreases proportionally from 36.4% of HL in smallest specimen examined (7.3 mm SL) to 17.4% of HL in largest (25.8 mm SL); profile of abdomen deeply constricted into two parts; nostril separates into two at 25.8 mm; notochord flexion starts at 12.7 mm and completes at 15.7 mm SL.

Rudiment of nasal spine appears at 21.0 mm; in largest specimen examined, nasal spine sharp and directed backward; supraocular spine and another spine just behind it appear at 15.7 mm; supraocular ridge becomes obvious at 21.0 mm; smallest specimen examined has four fronto-parietal spinules without fronto-parietal ridge; fronto-parietal ridge appears at 9.9 mm; fronto-parietal spinules disappear at 17.7 mm; preopercular spines formed as double row (anterior and

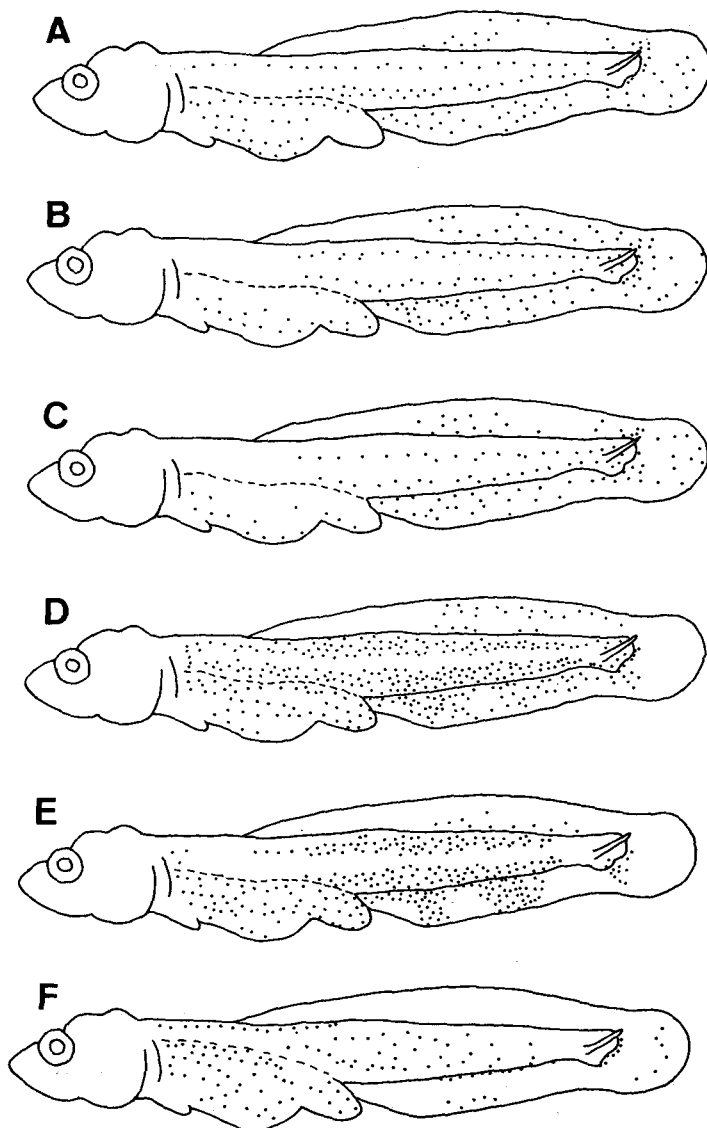

Fig. 26. Diagrammatic sketches of pigment patterns on trunk in flexion and early postflexion larvae of Agoninae. A, *Podotheucus sachi*; B, *P. gilberti*; C, *P. thompsoni*; D, *P. sp.* E, *Sarritor leptorhynchus*; F, *Bothragonus occidentalis*.

posterior) at 15.7 mm; each row consists of two spines at 15.7-17.7 mm and four spines at 20.1-21.0 mm; each preopercular spine of anterior row gradually extends over each spine of posterior row, and fuse at tip to form canal; posttemporal spine appears at 20.1 mm; two postocular spines appear at 21.0 mm; each branchiostegal ray lacks process near proximal tip (Fig. 30H).

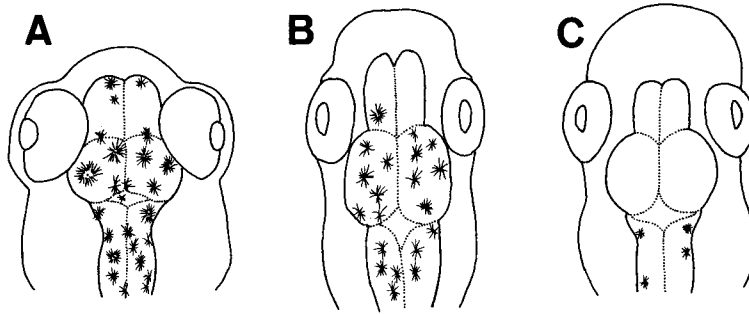

Fig. 27. Comparison of melanophores on brain among three species of Agoninae. A, *Bothragonus occidentalis*, 7.7 mm; B, *Podothecus* sp., 10.6 mm; C, *P. sachi*, 10.8 mm.

Full complements of bony plates appear in DLR at 12.0 mm, in MDR at 20.1 mm, in ILR at 12.7 mm and in VLR at 17.7 mm, and do not appear in LLP in largest specimen examined; upper row of PLLP present above lateral median line as single row in smallest specimen examined; in largest specimen examined, double row of ALLP formed anterior to upper row of PLLP.

Full complements of fins appear in dorsal and anal fins at 12.7 mm and in pelvic fin at 25.7 mm; full complements of pectoral fin rays already acquired in smallest specimen examined; spinous dorsal fin absent; dorsal fin starts over middle of 20th-21st to middle of 23rd-24th DLR and ends over 24th to 27th; anal fin starts under middle of 18th-19th to 19th VLR and ends under middle of 21st-22nd to 22nd; pectoral fin length increases from 8.1-9.6% of SL in preflexion phase to 19.8-22.4% of SL in postflexion phase; posterior end of pectoral fin reaches level of anus at 15.7 mm; median finfold still high in largest specimen examined; early larvae have small preanal finfold, which disappears at 9.9 mm.

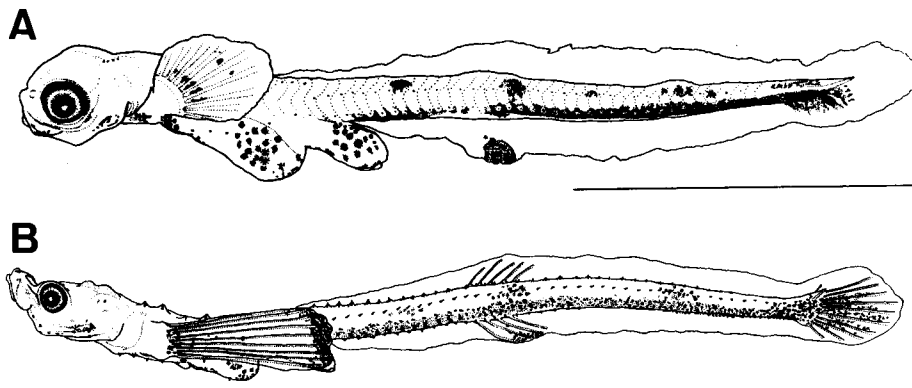

Fig. 28. Larvae of *Aspidophoroides bartoni*. A, 7.3 mm; B, 17.7 mm. Each scale indicates 3 mm.

Table 22. Development of meristic structures in *Aspidophoroides bartoni*.

Spec. No.	SL (mm)	Developmental stage	Dorsal fin rays	Anal fin rays	Pectoral fin rays	Pelvic fin rays	Bony plates			
							DLR+MDR	ILR	VLR+MVR	LLP*
1601	7.3	Preflexion	0	0	9	—	8	41	5	0+37**
1602	8.0	Preflexion	0	0	9	—	6	42	2	0+37**
1603	9.0	Preflexion	2	0	9	—	8	45	3	0+38**
1604	9.9	Preflexion	0	0	9, 8*	—	6	41	2	0+38**
1605	12.7	Flexion	6	6	9	Buds	32	48	15	0+42**
1606	15.7	Postflexion	5	5	9	Buds	46	52	34	0+43**
1607	17.7	Postflexion	5	4	9	Buds	47	51	34	0+44**
1608	20.1	Postflexion	5	4	9	Buds	50	53	42	0+46**
1609	21.0	Postflexion	5	5	9	Buds	50	52	40	0+46**
1610	25.8	Postflexion	5	5	9	I, 2	48	50	40	6+41**

\* Right side

\*\* ALLP+PLLP.

Table 23. Meristic structures in *Anoplagonus occidentalis*.

Spec. No.	SL (mm)	Developmental stage	Dorsal fin rays	Anal fin rays	Pectoral fin rays	Pelvic fin rays	Bony plates			
							DLR+MDR	ILR	VLR+MVR	LLP*
1701	11.2	Flexion	5	4	10	Buds	31	39	28	0+32

\* ALLP+PLLP.

## 3) Pigmentation

Dorsolateral surface of body has four or five blotches ; first situated at middle between base of hindgut and origin of dorsal fin, second between posterior ends of dorsal and anal fins, third present (two specimens) or absent (eight specimens) on middle of tail, fourth on middle between posterior end of dorsal fin and posterior end of body, and fifth on caudal peduncle and upper part of posterior end of notochord ; ventrolateral body heavily pigmented to form horizontal band extending from base of hindgut to end of body ; band tends to be paler above origin of anal fin than rest part ; isthmus heavily pigmented ; fore-, mid- and hindbrain unpigmented throughout preflexion and flexion phases ; a few melanophores appear on hindbrain at 17.7-21.1 mm ; largest specimen examined has melanophore on forebrain and many melanophores on mid- and hindbrain ; gular region unpigmented in all but one specimen (21.0 mm SL), which has single melanophore.

Median dorsal finfold unpigmented in all but one specimen (15.7 mm SL), which has a few melanophores on base of last dorsal fin ray ; anal median finfold has large heavily pigmented blotch, rounded in preflexion and flexion phases and bar-like in postflexion phase ; a few melanophores present or absent above blotch on anal fin ; smallest specimen examined has heavily pigmented blotch on base of caudal fin ; blotch expands to whole caudal fin except for margin with development ; pectoral fin pigmented on base and posterior part in smallest specimen examined ; pigmented area on posterior part of pectoral fin migrates posteriorly to form heavily pigmented outer margin ; a few melanophores present or absent on middle of pectoral fin ; pelvic fin unpigmented in preflexion and flexion phases, and starts to be pigmented on base at 15.7 mm.

*Anoplagonus occidentalis* Lindberg

Japanese name : Nise-nametokubire (Fig. 29, Table 23)

## 1) Specimen examined

Number of specimen, length of specimen and its developmental stage are shown in Table 23.

## 2) Morphology

Meristic counts are shown in Table 23.

Body elongate, its depth 6.3% of SL ; snout to anus length 51.8% of SL ; head length 23.2% of SL ; snout length 26.9% of HL ; eye diameter 26.9% of HL ; profile of abdomen constricted into two parts ; nostril not separated yet ; notochord flexing.

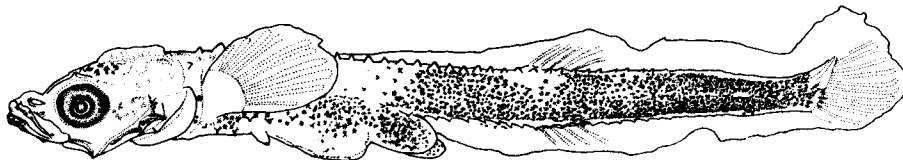

Fig. 29. Larva of *Anoplagonus occidentalis*. 11.2 mm. Scale indicates 3 mm.

Nasal spine absent; supraocular ridge with spine present; fronto-parietal ridge present, its upper edge almost straight; another small spine present between supraocular ridge and fronto-parietal ridge; postocular spines not present; post-temporal spine present; two rows of preopercular spines (anterior and posterior) present; anterior row has three spines and posterior row has two spines; lowermost spine of anterior row extended over lowermost spine of posterior row to form canal; each branchiostegal ray lacks process near proximal tip.

Full complements of bony plates in all rows not yet acquired; upper row of PLLP present extending from constricted part of abdomen to end of body.

Full complements of all fins except for pelvic fin already acquired; spinous dorsal fin absent; dorsal fin starts over 21st DLR and ends over 24th; anal fin starts under 18th VLR and ends under 21st; pectoral fin length 12.5% of SL; posterior end of pectoral fin not reached level of anus; median finfold still high; small preanal finfold present.

### 3) Pigmentation

Posterior two-thirds of body heavily pigmented except for margin, below dorsal fin, and upper hypural; pigmented area on body a little paler below part somewhat posterior to dorsal fin and on lateral line; dorsolateral surface of abdomen heavily pigmented with small melanophores; isthmus heavily pigmented; gill membranes and the gular region unpigmented; fore-, mid- and hindbrain heavily pigmented.

Dorsal median finfold unpigmented; anal median finfold has three melanophores on middle between anus and origin of anal fin, and one melanophore on base of last anal fin ray; four melanophores on bases of lower caudal fin rays; pectoral fin unpigmented; pelvic fin pigmented at base.

## Summary and comparison of *Aspidophoroidinae*

### 1) Identification

The two developmental series of agonids are recognized as the members of

Table 24. Comparison of meristic counts between present larvae and juveniles, and adults of two species of *Aspidophoroidinae* in Japan. Adult's data are from Kanayama (1984).

	Larvae and juveniles		Adults	
	<i>Aspidophoroides bartoni</i>	<i>Anoplagonus occidentalis</i>	<i>Aspidophoroides bartoni</i>	<i>Anoplagonus occidentalis</i>
Dorsal fin rays	5-6	5	5-6	4-6
Anal fin rays	4-6	4	4-6	4-5
Pectoral fin rays	8-9	10	9-10	10
DLR + MDR	48-50	31*	44-57	40-47
ILR	48-53	39	48-53	39-43
VLR + MVR	40-42	28*	41-53	38-44

\* Incomplete.

Aspidophoroidinae by their lack of a spinous dorsal fin (Nelson, 1984), and can be identified to species by a comparison of meristic structures with adults (Table 24). *Aspidophoroides bartoni* has 48-53 bony plates on ILR, and the largest specimen has a sharp nasal spine, a diagnostic character of *Aspidophoroides* (Freeman, 1951). *Anoplagonus occidentalis* has 39 bony plates on ILR.

## 2) Other useful characters for identification

*Body depth.*— Body depth is greater in *Anoplagonus occidentalis* than in *Aspidophoroides bartoni*. Body depth is 6.3% of SL in *A. occidentalis*, but is less than 5.5% of SL in *A. bartoni* throughout the larval period.

*Snout to anus length.*— Snout to anus length is proportionally longer in *Anoplagonus occidentalis* (51.8% of SL) than in *Aspidophoroides bartoni* (33.3-45.2% of SL).

*Lateral surface of body.*— *Aspidophoroides bartoni* has a heavily pigmented horizontal band extending from the base of the hindgut to the end of the body and four to five blotches on the dorsolateral body (Fig. 28). In *Anoplagonus occidentalis*, the posterior two-thirds of body is heavily pigmented except for its margin and a part below the dorsal fin (Fig. 29).

*Anal fin.*— *Aspidophoroides bartoni* has a round (Fig. 28A) or bar-like (Fig. 28B) blotch on the posterior part of the anal fin, but *Anoplagonus occidentalis* has only a few melanophores on the base of the median anal finfold (Fig. 29).

*Caudal fin.*— *Aspidophoroides bartoni* differs from *Anoplagonus occidentalis* in having a heavily pigmented caudal fin, while the latter has a few melanophores on the lower caudal fin rays.

*Pectoral fin.*— The pectoral fin is pigmented on its base and posterior part in *Aspidophoroides bartoni* (Fig. 28), and unpigmented in *Anoplagonus occidentalis* (Fig. 29).

*Brain.*— *Aspidophoroides bartoni* has no melanophores on the fore-, mid- and hindbrain throughout the preflexion and flexion phases. The hindbrain starts to be pigmented in the flexion phase. The fore- and midbrain starts to be pigmented in the late postflexion phase. Flexion larvae of *Anoplagonus occidentalis* already have heavily pigmented brain regions.

## 3) Comparison with other aspidophoroidine species

Bigelow and Schroeder (1953) and Washington *et al.* (1984) illustrated the larvae of *Aspidophoroides monopterygius* without descriptions. Judging from their illustrations (Washington *et al.*, 1984, Fig. 232F), *Aspidophoroides bartoni* (Fig. 28) differs from *Aspidophoroides monopterygius* in having melanophores on the base of the pectoral fin (lacking melanophores in the latter). Dunbar (1947) described and illustrated the postflexion larva of *Aspidophoroides olriki*. *A. bartoni* (Fig. 28) differs from *A. olriki* as follows: (1) *A. bartoni* has a horizontal band extending from the base of the hindgut to the end of the body on the ventrolateral part of body; *A. olriki* lacks this band. (2) *A. bartoni* has no heavily pigmented blotches on the dorsal fin, but *A. olriki* has a large blotch. (3) *A. bartoni* has a large blotch on the caudal fin, while *A. olriki* has a small blotch on its base.

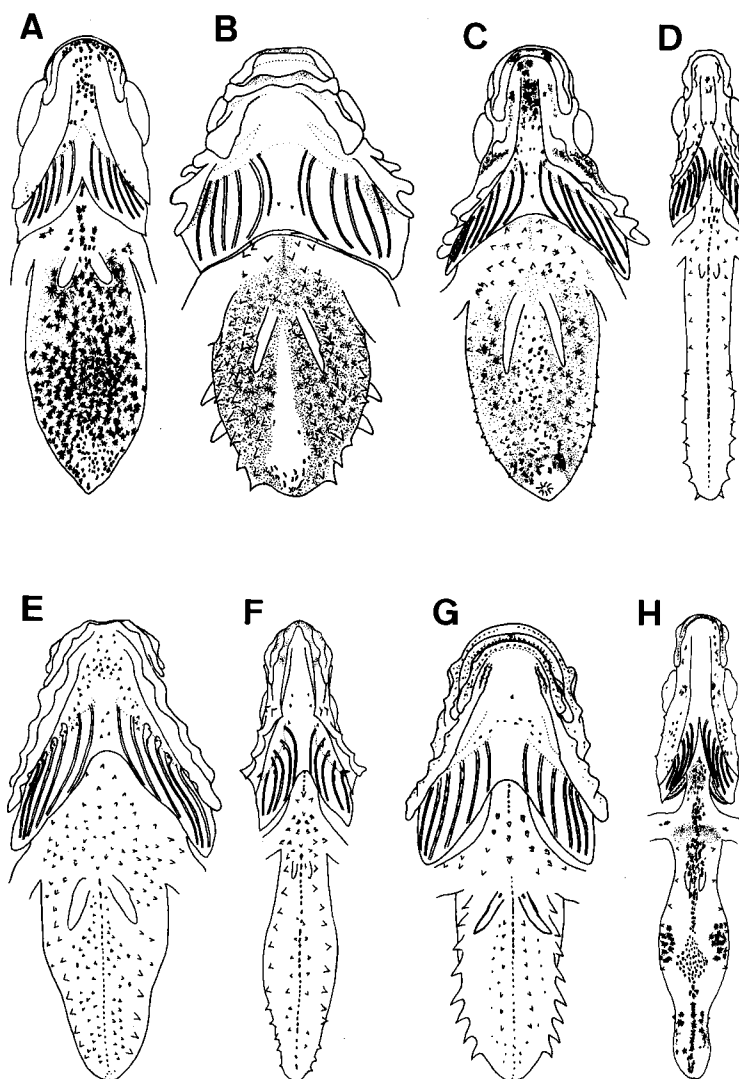

Fig. 30. Diagnostic sketches showing ventral views of eight agonid species. A, *Percis japonicus*; B, *Hypsagonus* sp.; C, *Agonomalus proboscidalis*; D, *Tilesina gibbosa*; E, *Occella dodecaedron*; F, *Pallasina* sp.; G, *Podothecus sachi*; H, *Aspidophoroides bartoni*.

## V. Discussion

Body shape of agonid larvae ranges from short and stout in Percidinae to elongate in *Tilesina* and *Aspidophoroides*. The larval body form reflects that of the adult in most species. *Percis japonicus* is, however, elongate in adults, but in larvae it is stout as in the other members of Percidinae.

Agonid larvae are characterized by spiny heads with large fronto-parietal ridges, postocular spines, and four preopercular spines (Washington *et al.* 1983). Nasal, postocular and posttemporal spines are formed in pairs at first and each pair fuses later to form canals. Another conspicuous character is the bony plates (spines) on the body. Bony plates are formed initially as dull projections in the subfamily Percidinae and as tiny spines in all other subfamilies. Rows of bony plates are completed in SLR and ILR first and in LLP last. MDR, MVR and LLP are formed as paired rows of bony plates at first and each pair probably fuses to form a single bony plate in adults.

Agonids are divided into some groups according to the larval characters (Table 25).

Agonid larvae may be divided into three groups on the basis of the pigment pattern of the ventral surface of abdomen. In the first group, the Percidinae, the ventral surface of abdomen is either pigmented wholly or lacks pigment only along the midline (Fig. 30A-C). The second group is composed of the species of Tilesininae, Brachyopsinae and Agoninae. These have a row of melanophores running along the midline of the ventral surface of the abdomen (Fig. 30D-G). In the third group consisting of the species of Aspidophoroidinae, the ventral surface of the abdomen at the posterior part of the midgut has a heavily pigmented blotch (Fig. 30H).

Agonids are divided into two groups according to the pigment pattern of the gill membranes. The first group comprises the species of Agoninae. In this group, the melanophores on the gill membranes are regularly arranged along each branchiostegal rays (Fig. 30G), although sometimes the first and second branchiostegal rays lack melanophores. The second group is composed of the species of Percidinae, Tilesininae, Brachyopsinae and Aspidophoroidinae. In this group, the melanophor-

Table 25. Comparison of larval characters among five subfamilies.

Larval character	Percidinae	Tilesininae Brachyopsinae	Agoninae	Aspidophoroidinae
Melanophores on ventral surface of abdomen	Wholly pigmented or except for middle part	A row of melanophores	A row of melanophores	A heavily pigmented blotch on posterior midgut
Melanophores on gill membranes	Absent or irregularly arranged	Absent or irregularly arranged	Regularly arranged all along each branchiostegal ray	Absent or irregularly arranged
Process on branchiostegal ray	Absent	Present	Absent	Absent
Formation pattern of LLP	Pattern I	Pattern I	Pattern II (Pattern I in <i>Bothragonus occidentalis</i> )	Pattern III

es on the gill membranes are entirely absent or irregularly arranged at the proximal part of each branchiostegal ray in the late larval period (Fig. 30A-F, H).

Two larval groups are recognized on the basis of the presence or absence of processes on the branchiostegal rays. The first group consists of the species of Tilesininae and Brachyopsinae, which have six branchiostegal rays with a process on each third to fifth branchiostegal ray (Fig. 30D-E); *Pallasina* sp. has five branchiostegal rays with a spiny process on each second to fourth branchiostegal ray (Fig. 30F). The second group consists of the species of Percidinae, Agoninae and Aspidophoroidinae. These lack processes on the branchiostegal rays (Fig. 30D-F).

Three patterns (formation pattern I, II and III) are recognized in the process of formation of LLP in agonid larvae. Formation pattern I is recognized in the species of Percidinae, Tilesininae, Brachyopsinae and *Bothragonus occidentalis* in Agoninae. Formation pattern II occurs in the species of Agoninae except for *Bothragonus occidentalis*. Formation pattern III is recognized in the members of Aspidophoroidinae.

Jordan and Evermann (1898) first established four subfamilies, Percidinae, Brachyopsinae, Agoninae and Aspidophoroidinae, in the family Agonidae. Jordan and Starks (1903) created a new subfamily Tilesininae and recognized five subfamilies. Freeman (1951) reviewed the family and recognized four subfamilies based on external morphology. He divided Jordan and Evermann's Agoninae into two subfamilies, Agoninae and Xeneretminae, and moved Aspidophoroidinae into the latter subfamily and moved Tilesininae into Brachyopsinae. Judging from these larval characters, the subfamilies Percidinae and Aspidophoroidinae, are considered as natural groups, since each has at least one unique larval character (Table 25). There are no differences between Tilesininae and Brachyopsinae in larval characters, but they share one unique larval character, the presence of projections on branchiostegal rays. We suggest that they may be a natural group, supporting Freeman's classification. Judging from the formation pattern of LLP, Agoninae is considered as a natural group, except for *Bothragonus occidentalis*. In Freeman's classification, *B. occidentalis* belongs to Xeneretminae with the genera *Aspidophoroides* and *Anoplagonus* (Aspidophoroidinae in Jordan and Evermann's classification). Recently, Leipertz (1985) hypothesized that *Bothragonus* and *Aspidophoroides* are closely related on the basis of cladistic analysis. *B. occidentalis*, however, differs from the members of Aspidophoroidinae in several larval characters as shown in Table 25. On the basis of larval characters, we believe that *B. occidentalis* belongs neither to Agoninae nor to Aspidophoroidinae.

## VI. Summary

(1) About 200 specimens of agonid larvae and juveniles collected from waters around Hokkaido were examined in this study. As a result, 17 species listed below were identified.

### Percidinae

*Percis japonicus* (Pallas)

*Hypsagonus* sp.

*Agonomalus proboscidalis* (Valenciennes)

- Agonomalus jordani* Schmidt  
 Tilesininae  
*Tilesina gibbosa* Schmidt  
 Brachyopsinae  
*Ocella dodecaedron* (Tilesius)  
*Ocella* sp.  
*Brachyopsis rostratus* (Tilesius)  
*Pallasina* sp.  
 Agoninae  
*Podothecus sachi* (Jordan and Snyder)  
*Podothecus gilberti* (Collett)  
*Podothecus thompsoni* Jordan and Gilbert  
*Podothecus* sp.  
*Sarritor leptorhynchus* (Gilbert)  
*Bothragonus occidentalis* Lindberg  
 Aspidophoroidinae  
*Aspidophoroides bartoni* Gilbert  
*Anoplagonus occidentalis* Lindberg

(2) Developmental morphology and pigmentation were described and illustrated in detail for each species.

(3) The larvae and juveniles of the 13 identified species were reported for the first time. Larvae and juveniles of six genera, *Percis*, *Tilesina*, *Brachyopsis*, *Podothecus*, *Sarritor* and *Anoplagonus*, have not been known until now.

(4) In each subfamily, useful characters for identification to species level were clarified in the present study.

(5) The validity of subfamilies were reconsidered based on several larval characters: pigmentation of ventral surface of abdomen, pigmentation of gill membranes, processes on branchiostegal rays, and formation patterns of lateral line plates (LLP).

(6) Percidinae was considered as a natural group by having a unique larval character, the ventral surface of abdomen pigmented wholly or except for the part along its midline.

(7) Brachyopsinae and Tilesininae lack a unique larval character, but they seem to be a natural group based on the presence of processes on branchiostegal rays.

(8) We hypothesize that Agoninae is a natural group since it has a unique larval character, melanophores on the gill membranes regularly arranged all along the branchiostegal rays. It is necessary to investigate whether *Bothragonus occidentalis* belongs to the subfamily Agoninae, since it shares the formation pattern I (LLP) with the species of Percidinae, Tilesininae and Brachyopsinae.

(9) The validity of the subfamily Aspidophoroidinae was supported by two unique larval characters: presence of a heavily pigmented blotch on the ventral surface of the abdomen and formation pattern III (LLP).

## VII. Literature cited

- Ahlstrom, E.H., J.L. Butler and Y. Sumida. 1976. Pelagic stromateoid fishes (Pisces, Perciformes) of

- the eastern Pacific: kinds, distributions and early life histories and observations on five of these from the Northwest Atlantic. *Bull. Mar. Sci.*, 26(3): 285-402.
- Bigelow, H.B. and W.C. Schroeder. 1953. Fishes of the Gulf of Maine. U.S. Fish. Wildl. Serv., Fish. Bull., 53: i-iii+1-577.
- Dunbar, M.J. 1947. Marine young fish from the Canadian eastern Atlantic. *Bull. Fish. Res. Bd. Can.*, (73): 1-11.
- Ehrenbaum, E. 1905. Eier und Larven von Fischen. *Nord. Plankton* 1, 4: 1-216.
- Freeman, H.W. 1951. Contribution on the evolution and classification of the fishes of the family Agonidae. Unpubl. Ph. D. Dissertation, Stanford Univ., 288 pp.
- Gruchy, C.G. 1969. Canadian records of the warty poacher *Occa verrucosa*, with notes on the standardization of plate terminology in Agonidae. *J. Fish. Res. Bd. Can.*, 26(6): 1467-1472.
- Hart, J.L. 1973. Pacific fishes of Canada. *Bull. Fish. Res. Bd. Can.*, (180): i-ix+1-740.
- Jordan, D.S. and B.W. Evermann. 1898. The fishes of North and Middle America: a descriptive catalogue of the species of fishlike vertebrates found in the waters of North America, north of the Isthmus of Panama. Part II. *Bull. U.S. Natn. Mus.*, 47(2): i-xxvii+1241-2183.
- Jordan, D.S. and E.C. Starks. 1904. A review of the Japanese fishes of the family Agonidae. *Proc. U. S. Natn. Mus.*, 27 (1365): 575-599.
- Kanayama, T. 1984. Family Agonidae, Pages 331-333, Plates 297-298 in Masuda, H., K. Amaoka, C. Araga, T. Uyeno and T. Yoshino eds. The fishes of the Japanese Archipelago. Tokai Univ. Press, Tokyo.
- Leipertz, S.L. 1985. A review of the fishes of the agonid genus *Xeneretmus* Gilbert. *Proc. Cal. Acad. Sci.*, 44(3): 17-40.
- Marliave, J.B. 1978. Spawning and yolk-sac larvae of the agonid fish, *Agonomalus mozinoi* Wilimovsky and Wilson. *Syesis*, 11: 285-286.
- Matsubara, K. 1955. Fish morphology and hierarchy. Part II. Ishizaki-shoten, Tokyo, i-v+791-1377 pp. (In Japanese).
- Miller, D.J. and R.K. Lea. 1972. Guide to the coastal marine fishes of California. *Calif. Dep. Fish. Game, Fish Bull.*, (157): 1-235.
- M'Intosh, W.C. and E.E. Prince. 1890. On the development and life-histories of the teleostean food- and other fishes. *Trans. R. Soc. Edinb.*, 35(19): 665-946, pls. 1-28.
- Nelson, J.S. 1984. Fishes of the World. 2nd ed. John Wiley and Sons, Inc., New York., xv+523 pp.
- Taranetz, A. 1933. New data on the ichthyofauna of the Bering Sea. *Rep. Far-East Sect. Acad. Sci. U.S.S.R.*, 1-3: 69-78. (In Russian with English summary).
- Washington, B.B., H.G. Moser, W.A. Laroche and W.J. Richards. 1984. Scorpaeniformes: Development. Pages 405-428 in Moser, H. G., W.J. Richards, D.M. Cohen, M.P. Fahay, A.W. Kendall, Jr. and S.L. Richardson, eds. Ontogeny and systematics of fishes based on an international symposium dedicated to the memory of Elbert Halvor Ahlstrom. *Amer. Soc. Ichthyol. Herpetol., Spec. Publ.*, (1).