



# HOKKAIDO UNIVERSITY

Title	PHYLOGENY OF THE SUBORDER MYLIOBATIDOIDEI
Author(s)	NISHIDA, Kiyonori
Citation	MEMOIRS OF THE FACULTY OF FISHERIES HOKKAIDO UNIVERSITY, 37(1-2), 1-108
Issue Date	1990-12
Doc URL	<a href="https://hdl.handle.net/2115/21887">https://hdl.handle.net/2115/21887</a>
Type	departmental bulletin paper
File Information	37(1_2)_P1-108.pdf



# PHYLOGENY OF THE SUBORDER MYLIOBATIDOIDEI

By

Kiyonori NISHIDA\*

*Laboratory of Marine Zoology, Faculty of Fisheries, Hokkaido  
University, Hakodate, Hokkaido 041, Japan*

## Contents

	Page
I. Introduction .....	2
II. Materials .....	2
III. Methods .....	6
IV. Systematic methodology .....	6
V. Out-group definition .....	9
1. Monophyly of the Rajiformes .....	9
2. Higher rajiform phylogeny .....	9
3. Discussion .....	15
VI. Comparative morphology and character analysis .....	17
1. Skeleton of the Myliobatidoidei .....	17
1) Neurocranium .....	17
2) Visceral arches .....	34
3) Scapulocoracoid (pectoral girdle), pectoral fin and cephalic fin .....	49
4) Pelvic girdle and pelvic fin .....	56
5) Vertebrae, dorsal fin and caudal fin .....	59
2. Muscle of the Myliobatidoidei .....	66
1) Head and visceral muscles .....	66
2) Other muscles .....	79
3. Other body parts .....	81
VII. Myliobatidoid phylogeny .....	88
1. Monophyly of the Myliobatidoidei .....	88
2. Character states and distribution .....	89
3. Interrelationships of the Myliobatidoidei .....	91
4. Phylogenetic classification .....	97
VIII. General discussion .....	100
IX. Summary .....	102
X. Acknowledgments .....	103
XI. Literature cited .....	104

---

The present work was submitted as a partial fulfillment of the requirements for Doctor's degree in Fisheries Science at Hokkaido University in 1989.

\* Present address: Ring of Fire International Marine Biological Research Institute, Osaka Aquarium, Kaigan-dori, Minato-ku, Osaka 552, Japan.

## I. Introduction

The rajiform suborder Myliobatidoidei contains more than 150 species (Nelson, 1984; Notarbartolo-Di-Sciara, 1987; Rosa et al., 1987; Miyake and McEachran, 1988; Nishida and Nakaya, 1988a; 1988b). The suborder is distributed worldwide in tropical, subtropical and temperate waters. Most species are benthic and are restricted to continental shelves. A few are pelagic (e.g., *Dasyatis violacea*, *Manta birostris*), and some others are deep water dwellers (e.g., *Hexatrygon bickelli*). Species of *Potamotrygon*, *Paratrygon* and *Plesiotrygon* are confined to freshwater, and *Dasyatis garouaensis*, *Himantura krempfi* and *H. signifier* have also been reported only from the freshwater habitats (Compagno and Roberts, 1982).

There are very few phylogenetic works, dealing with the Myliobatidoidei. Heemstra and Smith (1980), and Rosa et al. (1987) treated parts of the suborder, but Luther (1909), Garman (1913), Daniel (1922), Holmgren (1940, 1941), and Lamarca (1964), who studied internal characters, such as skeleton and muscles, provided only descriptions of such characters. Accordingly, current classifications of the Myliobatidoidei have little phylogenetic foundation, and may vary considerably between authors. Müller and Henle (1841) divided the myliobatidoids into three categories; Trygones, Myliobatides and Cephalopterae, and Günther (1870) recognized two families; Trygonidae and Myliobatidae. Garman (1913), Jordan (1923) and White (1937) all recognized five families; Dasyatidae, Potamotrygonidae, Myliobatidae, Rhinopterae and Mobulidae, but Bertin (1939) again restricted the suborder to three families; Dasyatidae, Myliobatidae and Mobulidae. Bigelow and Schroeder (1953) proposed seven families; Dasyatidae, Potamotrygonidae, Gymnuridae, Urolophidae, Myliobatidae, Rhinopterae and Mobulidae. Recently, Heemstra and Smith (1980) described *Hexatrygon bickelli*, establishing a new suborder Hexatrygonoidei, but Nelson (1984) included *Hexatrygon* in the family, one of five myliobatidoid families that he accepted. It is clear that not only is a comprehensive phylogenetic study of the Myliobatidoidei strongly needed, but also that the monophyly of the group remains to be demonstrated.

The purposes of this study are: to clarify the monophyly of the Myliobatidoidei; to describe skeletal and myological characters in detail, as a basis for estimating phylogenetic relationships within the suborder; and to propose a new classification of the suborder, which more accurately reflects those relationships.

## II. Materials

The specimens examined in this study are listed below. Institutional abbreviations follow Leviton et al. (1985). An asterisk after the catalogue number indicates that the specimen was examined only by radiograph or partial dissection.

### Myliobatidoidei

*Aetobatus narinari* (Euphrasen): 1 specimen, HUMZ 96490, 1,016 mm TL, 531 mm DW, female.

*Aetomylaeus nichofii* (Schneider): 1 specimen, HUMZ 109481, 931 mm TL, 519 mm DW, male.

*Aetoplatea zonura* (Bleeker): 2 specimens, HUMZ 37622, 420 mm TL, 543 mm DW, female, HUMZ 37663, 492 mm TL, 608 mm DW, male.

*Dasyatis acutirostra* Nishida and Nakaya: 18 specimens, HUMZ 107597, 810 mm TL, 316 mm DW, male, HUMZ 97435\*, 1,763 mm TL, 725 mm DW, male HUMZ 107583-107596\*, 705-990 mm TL, 281-348 mm DW, 6 males and 8 females, HUMZ 107598, 107599\*, 845, 813 mm TL, 339, 316 mm DW, female, male.

*D. akajei* (Müller and Henle): 3 specimens, HUMZ 34858, 435 mm TL, 234 mm DW, male, HUMZ 103761, 818 mm TL, 409 mm DW, male, HUMZ 105346, 450 mm TL, 195 mm DW, female.

*D. americana* Hildebrand and Schroeder: 1 specimen, NSMT-P 40564, 864 mm TL, 310 mm DW.

*D. bennetti* (Müller and Henle): 2 specimens, HUMZ 101477, 1,218 mm TL, 326 mm DW, male HUMZ 101469\*, 708 mm TL, 191 mm DW, female.

*D. brevis* (Garman): 1 specimen, LACM 31759-16, 467 mm TL, 225 mm DW, male.

*D. centroura* (Mitchill): 1 specimen, USNM 199003, 983 mm TL, 384 mm DW, female.

*D. guttata* (Bloch and Schneider): 1 specimen, NSMT-P 40565, 924 mm TL, 270 mm DW, male.

*D. izuensis* Nishida and Nakaya: 8 specimens, HUMZ 107444, 324 mm TL, 183 mm DW, female, HUMZ 109716\*, 572 mm TL, 362 mm DW, male HUMZ 109730-109733\*, 343-623 mm TL, 183-418 mm DW, 4 males, HUMZ 105476\*, 587 mm TL, 368 mm DW, female, HUMZ 105907\*, 396 mm TL, 228 mm DW, female.

*D. kuhlii* (Müller and Henle): 5 specimens, HUMZ 37684, 498 mm TL, 272 mm DW, male HUMZ 111743, 526 mm TL, 297 mm DW, female, HUMZ 37638\*, 523 mm TL, 264 mm DW, male, HUMZ 96486\*, 643 mm TL, 335 mm DW, female, HUMZ 103525\*, 602 mm TL, 324 mm DW, male.

*D. margaritella* Compagno and Roberts: 1 specimen, ISH 142/62, 612 mm TL, 209 mm DW, male.

*D. matsubarae* Miyosi: 3 specimens, HUMZ 75751, 617 mm TL, 362 mm DW, female, HUMZ 82490, 724 mm TL, 393 mm DW, male, HUMZ 111746, 536 mm TL, 338 mm DW, male.

*D. pastinaca* (Linnaeus): 2 specimens, HUCZ 6215, 449 mm TL, 224 mm DW, male, HUMZ 6221, 371 mm TL, 232 mm DW, male.

*D. sabina* (Leseuer): 1 specimen, USNM 127331, 540 mm TL, 203 mm DW, male.

*D. say* (Leseuer): 1 specimen, USNM 148326, 495 mm TL, 228 mm DW, male.

*D. sephen* (Forskål): 1 specimen, HUMZ 20643, 886 mm TL, 407 mm DW, male.

*D. violacea* (Bonaparte): 2 specimens, HUMZ 111742, 650 mm TL, 426 mm DW, male, HUMZ 111749, 905 mm TL, 383 mm DW, female.

*D. zugei* (Müller and Henle): 3 specimens, HUMZ 101474, 718 mm TL, 299 mm DW, male, HUMZ 107703, 658 mm TL, 263 mm DW, male, MNHN 1987-152\*, 316 mm TL, 137 mm DW, male.

*Gymnura altavela* Columna: 1 specimen, ISH 1349/64, 303 mm TL, 388 mm DW, male.

*G. japonica* (Schlegel): 2 specimens, HUMZ 48301, 337 mm TL, 475 mm DW, female, HUMZ 48306, 303 mm TL, 436 mm DW, male.

*G. marmorata* Cooper: 2 specimens, LACM 27 W52-246, 205 mm TL, 308 mm DW, male, CAS 18471, 136 mm TL, 169 mm DW, male.

*G. micrura* (Bloch and Schneider): 1 specimen, FSFL L801, 260 mm TL, 340 mm DW, male.

*G. poecilura* (Shaw): 1 specimen, MTUF 20644, 362 mm TL, 425 mm DW, male.

*Hexatrygon longirostra* (Chu and Meng): 1 specimen, MTUF 23715, 907 mm TL, 633 mm DW, male.

*Himantura bleekeri* (Blyth): 2 specimens, MTUF 20614, 957 mm TL, 320 mm DW, male, MTUF 20615\*, 850 mm TL, 322 mm DW, male.

*H. gerrardi* (Gray): 2 specimens, MTUF 20610, 672 mm TL, 218 mm DW, male, MTUF

25104, 686 mm TL, 230 mm DW, female.

*H. imbricata* (Schneider) : 1 specimen, MTUF 20612, 344 mm TL, 175 mm DW, male.

*Manta birostris* (Walbaum) : 2 specimens, HUMZ 104834, 3,450 mm TL, 2,650 mm DW, male, HUMZ 105127, 1,151 mm TL, 704 mm DW, male.

*Mobula diabolus* (Shaw) : 1 specimen, HUMZ 103658, 843 mm TL, 428 mm DW, female.

*M. japonica* (Müller and Henle) : 1 specimen, HUMZ 96495, 1,394 mm TL, 845 mm DW.

*M. lucasana* Beebe and Tee-Van : 1 specimen, LACM 38433-1, 1,133 mm TL, 628 mm DW.

*Myliobatis aquila* (Linnaeus) : 1 specimen, ISH 59/56, 593 mm TL, 336 mm DW, female.

*M. californica* Gill : 1 specimen, LACM W62-90, 446 mm TL, 207 mm DW, male.

*M. freminvillei* Leseuer : 1 specimen, USNM 204770, 1,013 mm TL, 680 mm DW, male.

*M. goodei* Garman : 2 specimens, HUMZ 91851, 781 mm TL, 493 mm DW, male, HUMZ 91853, 874 mm TL, 539 mm DW, male.

*M. tobijeii* (Bleeker) : 4 specimens : HUMZ 35182, 471 mm TL, 255 mm DW, female, HUMZ 35617, 261 mm TL, 162 mm DW, female, HUMZ 107453, 311 mm TL, 197 mm DW, male, HUMZ 93845\*, 579 mm TL, 320 mm DW, female.

*Potamotrygon castexi* Castello and Yagolkowski : 2 specimens, LACM 39935-2, 894 mm TL, 414 mm DW, male, LACM 39934-1\*, 518 mm TL, 281 mm DW, female.

*P. hystrix* Roulin : 1 specimen, USNM 225575, 369 mm TL, 253 mm DW, male.

*P. magdalenae* Dumeril : 1 specimen, HUMZ 113415, 413 mm TL, 187 mm DW, male.

*P. motoro* Müller and Henle : 1 specimen, CAS 56633, 345 mm TL, 179 mm DW, female.

*P. yepezi* Castex and Castello : 6 specimens, HUMZ 100894, 431 mm TL, 195 mm DW, male, USNM 205280\*, 158-360 mm TL, 72-165 mm DW, 3 males and 2 females.

*Rhinoptera bonasus* Mitchell : 1 specimen, HUMZ 113416, 684 mm TL, 336 mm DW, female.

*R. javanica* Müller and Henle : 1 specimen, HUMZ 97698, 1,246 mm TL, 1,207 mm DW, female.

*Taeniura lymna* (Forskål) : 1 specimen, USNM 170470, 508 mm TL, 181 mm DW, female.

*T. meyeri* Müller and Henle : 1 specimen, HUMZ 6231, 612 mm TL, 326 mm DW, male.

*Urolophus aurantiacus* Müller and Henle : 2 specimens, HUMZ 92988, 269 mm TL, 178 mm DW, male, HUMZ 107442, 283 mm TL, 192 mm DW, male.

*U. concentricus* Nichols : 2 specimens, LACM 22608, 408 mm TL, 245 mm DW, female, AMNH 11802\*, 360 mm TL, 222 mm DW, male.

*U. expansus* McCulloch : 1 specimen, FSFL EC 888, 428 mm TL, 312 mm DW, male.

*U. halleri* Cooper : 1 specimen, LACM 39609-1, 302 mm TL, 172 mm DW, male.

*U. maculatus* Garman : 2 specimens, CAS (SU) 18378, 256 mm TL, 146 mm DW, male, CAS (SU) 18378\*, 277 mm TL, 157 mm DW, female.

*U. testaceus* (Müller and Henle) : 2 specimens, HUMZ 21005, 341 mm TL, 213 mm DW, male, HUMZ 21006, 360 mm TL, 236 mm DW, female.

*Urotrygon daviesi* Wallace : 2 specimens, MTUF 24994, 562 mm TL, 306 mm DW, female, MTUF 24993\*, 1,001 mm TL, 525 mm DW, female.

*U. asterias* (Jordan and Gilbert) : 2 specimens, LACM W51-57, 351 mm TL, 206 mm DW, male, LACM 51-56\*, 487 mm TL, 248 mm DW, female.

*U. microphthalmum* Delsman : 3 specimens, NSMT-P 40561, 218 mm TL, 108 mm DW, male, NSMT-P 40562\*, 272 mm TL, 133 mm DW, female, NSMT-P 40563\*, 186 mm TL, 105 mm DW, male.

*U. mundus* Gill : 1 specimen, LACM 30745-11, 199 mm TL, 108 mm DW, male.

#### Pristoidei

*Pristis microdon* Latham : 1 specimen, USNM 081066, 882 mm TL, 253 mm DW, male.

## Torpedinoidei

- Benthobatis marcida* Bean and Weed: 1 specimen, USNM 157984, 181 mm TL, 70 mm DW, male.
- Crassinarke dormitor* Takagi: 1 specimen, HUMZ 109705, 247 mm TL, 121 mm DW, male.
- Diplobatis pictus pictus* Palmer: 1 specimen, NSMT-P 40560, 149 mm TL, 64 mm DW, male.
- Discopyge tschudii* Tschudi: 1 specimen, HUMZ 91856, 375 mm TL, 205 mm DW, male.
- Heteronarce garmani* Regan: 1 specimen, CAS 58351, 229 mm TL, 116 mm DW, female.
- Narcine brasiliensis* (Olfers): 1 specimen, NSMT-P 40557, 280 mm TL, 144 mm DW, male.
- N. maculata* (Shaw): 1 specimen, HUMZ 37615, 234 mm TL, 128 mm DW, male.
- N. timlei* (Schneider): 1 specimen, HUMZ 37675, 188 mm TL, 91 mm DW, male.
- Narke japonica* (Schlegel): 2 specimens, HUMZ 94970, 262 mm TL, 144 mm DW, female, HUMZ 106448, 283 mm TL, 162 mm DW, male.
- Temera hardwickii* Gray: 1 specimen, CAS 58369, 110 mm TL, 56 mm DW, female.
- Torpedo nobiliana* Bonaparte: 1 specimen, NSMT-P 40554, 253 mm TL, 154 mm DW, male.
- T. tokionis* (Tanaka): 1 specimen, HUMZ 79517, 374 mm TL, 230 mm DW, male.
- Typhlonarke aysoni* (A. Hamilton): 1 specimen, HUMZ 91379, 230 mm TL, 117 mm DW, male.

## Rhinobatoidei

- Aptychotrema banksii* (Müller and Henle): 1 specimen, Aust. Mus. I. 20194-019, 344 mm TL, 129 mm DW, female.
- Platyrhinoidis triseriata* Jordan and Gilbert: 1 specimen, CAS 59621, 386 mm TL, 177 mm DW, male.
- Platyrhina sinensis* (Schneider): 1 specimen, HUMZ 107392, 456 mm TL, 238 mm DM, male.
- Rhina ancylostoma* Schneider: 1 specimen, CAS 56636, 483 mm TL, 227 mm DW, male.
- Rhynchobatus djiddensis* (Forskål): 2 specimens, HUMZ 6157, 616 mm TL, 208 mm DW, female, HUMZ 6137\*, 756 mm TL, 246 mm DW, male.
- Rhinobatos hymnicephalus* Richardson: 2 specimens, HUMZ 97105, 372 mm TL, 126 mm DW, male, HUMZ 105466, 377 mm TL, 126 mm DW, female.
- R. percellens* (Walbaum): 1 specimen, SNMT-P 40552, 462 mm TL, 132 mm DW, male.
- Trygonorhina fasciata* Müller and Henle: 1 specimen, Aust. Mus. I. 20194-039, 433 TL, 191 mm IW, female.
- Zanobatus schoenleinii* (Müller and Henle): 1 specimen, USNM 193991\*, 570 mm TL, 275 mm DW, female.
- Zapteryx exasperata* Jordan and Gilbert: 1 specimen, SIO 60-452-6A, 213 mm TL, 117 mm DW, female.

## Rajoidei

- Bathyraja smirnovi* Soldatov and Pawlenko: 1 specimen, HUMZ 84826, 651 mm TL, 430 mm DM, male.
- Psammobatis scobina* Philippi: 1 specimen, HUMZ 30157, 532 mm TL, 278 mm DW, male.
- Raja acutispina* Ishiyama: 1 specimen, HUMZ 95042, 349 mm TL, 253 mm DW, male.
- R. kenojei* Müller and Henle: 1 specimen, HUMZ 95047, 484 mm TL, 333 mm DW, male.
- R. pulchra* Liu: 1 specimen, HUMZ 92011, 464 mm TL, 363 mm DW, female.

*Rhinoraja longicauda* Ishiyama: 1 specimen, HUMZ 49122, 442 mm TL, 265 mm DW, male.

### III. Methods

For skeletal and myological studies, 57 myliobatidoid and 31 other rajiform species were dissected after being stained with alcian blue following the methods of Dingerkus and Uhler (1977). Rare specimens, including types, were examined using radiographs. Intraspecific variation and sexual dimorphism were checked by dissecting several specimens when possible. Drawings of the skeletons and muscles were made using a Wild M-8 drawing tube and Nikon SMZ-10 dissecting microscope. Terminology mainly follows Compagno (1977) (skeletons), Edgeworth (1935) (muscles), and Lamarca (1964) (claspers). Measurements follow Nishida and Nakaya (1988a). For counts of radial cartilage and vertebrae, radiographs were used according to Compagno and Roberts (1982). Tooth counts follow Stehmann (1981).

Character polarities were determined by outgroup analysis (see Chapter IV), and phylogenetic relationships were established by cladistic analysis.

### IV. Systematic methodology

In this study, systematic analyses are carried out as follows: 1) Selection of characters, 2) Determination of character polarities, 3) Construction of phylogenetic relationships, 4) Ranking of taxa. Each procedure is discussed below.

#### 1) Selection of characters.

Both internal and external characters were examined in this study. The former comprised mainly those from the skeletal and muscular systems, including neurocranium, visceral arches, scapulocoracoid (pectoral girdle), pectoral and cephalic fin cartilages, pelvic girdle and pelvic fin cartilage, vertebrae, and dorsal and caudal fin cartilages, as well as all of the head and body muscles. Other internal characters included brain, intestine, rectal gland, clasper. The external characters which have been used in the taxonomic study are also examined. Characters which vary within species (individual variation and sexual dimorphism), and those of questionable homology are omitted. In total, 45 characters (discussed below) were selected for this study.

#### 2) Determination of character polarities.

There are many methods (Maslin, 1952; Kluge and Farris, 1969; Hecht and Edwards, 1977; Eldredge, 1979; Wiley, 1981; Watrous and Wheeler, 1981; Sawada, 1982; Maddison et al., 1984; Yabe, 1985 etc.) for determining polarity. Amongst them, the most widely accepted method is out-group comparison (Maddison et al., 1984; Sakamoto, 1984). This is, however, criticized by several investigators. The commonality principle (Hecht and Edwards, 1977 etc.), that a character state which has the widest distribution amongst closely related taxa is primitive, was criticized by Sawada (1982) for its shortcomings in effectiveness. Furthermore,

Maddison et al. (1984) pointed out that the use of the most closely related out-group only may fail to achieve global parsimony. In determining polarity by outgroup analysis, it is necessary to extend it to as many outgroups as possible to avoid this problem. On this point, Maddison et al.'s method appears to be most appropriate. It aims not at local parsimony within the in-group, or within the in-group and its closest out-group, but at overall parsimony within the in-group and as many out-groups as possible. In this study, character polarities are determined by out-group analysis following the recommendations of Maddison et al. (1984), as follows.

These authors introduced a two-step procedure (Fig. 1) to find the in-group cladograms that are globally most parsimonious (over both in- and out-groups): (1) the ancestral states (at the out-group node) are estimated using out-groups and

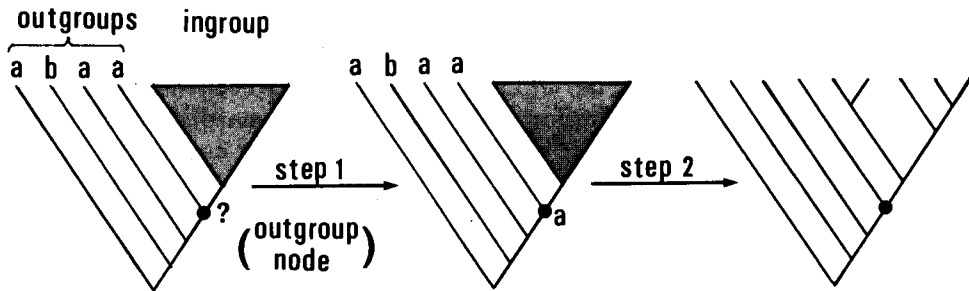

Fig. 1. Two step procedure (Maddison et al., 1984). First step: the ancestral states (at the out-group node) are estimated using the out-groups and parsimony. Second step: the most parsimonious in-group cladogram is sought.

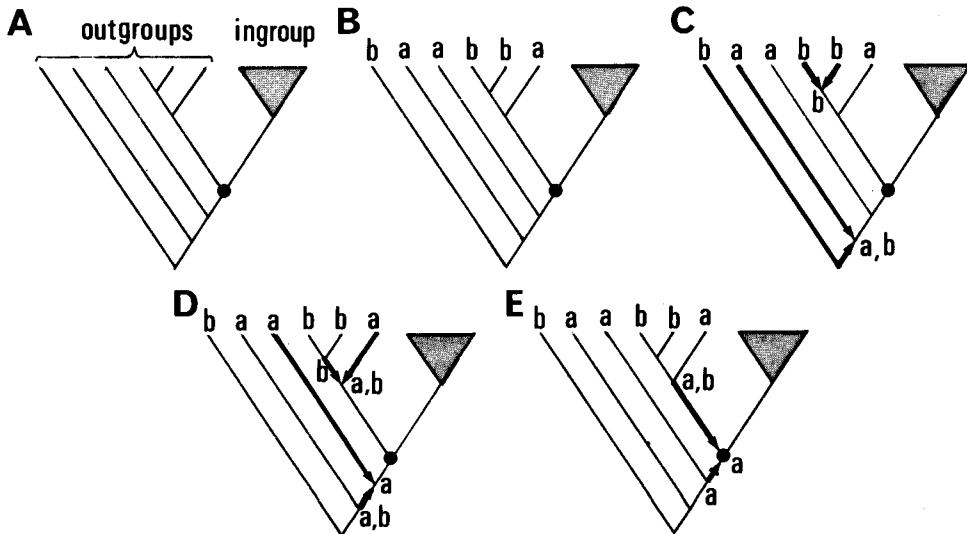

Fig. 2. Determination of the ancestral state (at the out-group node) with an application of the out-group algorithm (Maddison et al., 1984).

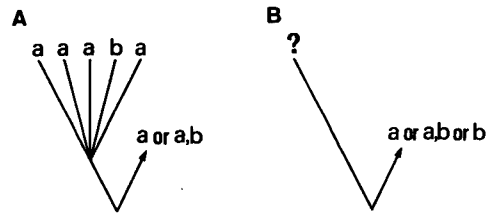

Fig. 3. The supplementary rule. A. One state "b" is present in only one of several out-groups (rule 6 in Maddison et al., 1984). B. Terminal state is not countable or questionable.

parsimony; (2) the most parsimonious in-group cladogram is constructed.

An example of its application (Fig. 2) is here briefly explained. Terminal taxa among the out-groups are labelled according to their observed states "a", "b" or "a, b" (Fig. 2B). Proceeding from the terminal taxa towards the out-group node, nodes are labelled according to the following rule: "a" if the two immediately-preceding nodes are labelled "a" and "a", or "a" and "a, b"; "b" if they are labelled "b", or "b" and "a, b"; "a, b" if they are labelled "a" and "b", or "a, b" and "a, b". Labelling proceeds towards the out-group node (Fig. 2C,D), until it too is finally labeled (Fig. 2E). Two supplementary rules are used in this study. The first (rule 6 in Maddison et al., 1984) is used when the out-group relationship is by polychotomy (Fig. 3A). When only one of several out-groups which have a polychotomous relationship has state "b", and others have state "a", then the ancestral state within the out-groups is assessed to be "a" or "a, b". The second rule is used when the state of the out-group cannot be determined (Fig. 3B). In this case, the terminal taxon is labelled "?", and the state is assessed as "a", "a, b" or "b". Thus the character state of the most recent common ancestor of the in-group and first out-group (out-group node) is estimated, and accordingly, character polarity is determined.

In this study, the rajiform suborders Pristioidei, Torpedinoidei, Rhinobatoidei and Rajoidei are of necessity considered to be out-groups of the suborder Myliobatidoidei, and their overall relationships are resolved beforehand (see Chapter V).

### 3) Construction of phylogenetic relationships.

In this study, phylogenetic relationships are constructed on the basis of cladistic analyses as formalized by Hennig (1966). Branching patterns are established by considering shared derived characters (synapomorphies). Character weighting is not considered, and conflict between two or more characters is resolved by parsimony (Nelson, 1970).

### 4) Ranking of taxa.

Wiley (1981) stated that any classification that exactly reflects the phylogenetic relationships of the taxa classified is a phylogenetic classification. However, there are several conventions (Hennig, 1966; Wiley, 1979) and differing points of view

(Mayr, 1974; Hennig, 1975) regarding "phylogenetic classification". Here, the method of Hennig (1966) is adopted, because it is considered to be the most straightforward reflection of phylogenetic relationships. In principle, sister groups should have the same rank, but if several choices are possible for ranking, such is given so as to minimize taxonomic changes.

## V. Out-group definition

As previously discussed (Chapter IV), it is necessary that out-group relationships be sufficiently resolved, before establishing phylogenetic relationships within the Myliobatidoidei. In this study, all other rajiform fishes are recognized as the out-group, both because the order is a clearly defined monophyletic group, and because no definite group can be selected as an out-group of the suborder Myliobatidoidei.

### 1. Monophyly of the Rajiformes

Rajiform monophyly is supported by the following synapomorphies (based mainly on Bigelow and Schroeder, 1953; Compagno, 1977; Heemstra and Smith, 1980; Maisey, 1984a; pers. obs.): 1. Pectoral propterygia anteriorly elongate and larger than mesopterygia. 2. Anterior vertebrae fused, forming a well developed synarcual. 3. Antorbital cartilage present. 4. Loss of orbital articulation between paratoquadrate cartilage and neurocranium. 5. Distal tip of last ceratobranchial cartilage articulating with scapulocoracoid. 6. Scapular process attached or articulated with vertebrae (synarcual). 7. Pseudohyoid bar present. 8. Free upper eyelid absent. 9. Gill openings wholly on ventral surface. 10. Pectoral fin origin anterior to level of gill openings. 11. Depressor rostri present. (Character numbers correspond to those in Fig. 4.)

### 2. Higher rajiform phylogeny

Hypothetical relationships within the Rajiformes were constructed by cladistic analysis (Fig. 4). The analysis included characters established in previous works (Compagno, 1973, 1977; Heemstra and Smith, 1980; Fechhelm and McEachran, 1984; McEachran, 1984), in addition to the present study. Character polarities were determined by comparison with sharks, utilizing in the main, both literature sources (Vetter, 1878; Marion, 1905; Luther, 1909; Garman, 1913; Daniel, 1928; White, 1937; Holmgren, 1940, 1941; Schaeffer, 1967; Zangerl, 1973; Compagno, 1973, 1977, 1988; Nakaya, 1975; Maisey, 1984a, 1984b; Dingerkus, 1986) and personal communications (K. Nakaya and S. Shirai). Conflict between two or more characters was resolved by parsimony (Nelson, 1970). Derived states are found only in the "branches" or taxa listed, except where otherwise stated. Character numbers correspond to these in Fig. 4.

#### Branch A

Branch A includes Pristoidaei.

12. Rostrum modified into a huge saw (Fig. 7A) (Compagno, 1973, 1977; Heemstra and Smith, 1980). The huge, saw-like rostrum is not observed in other

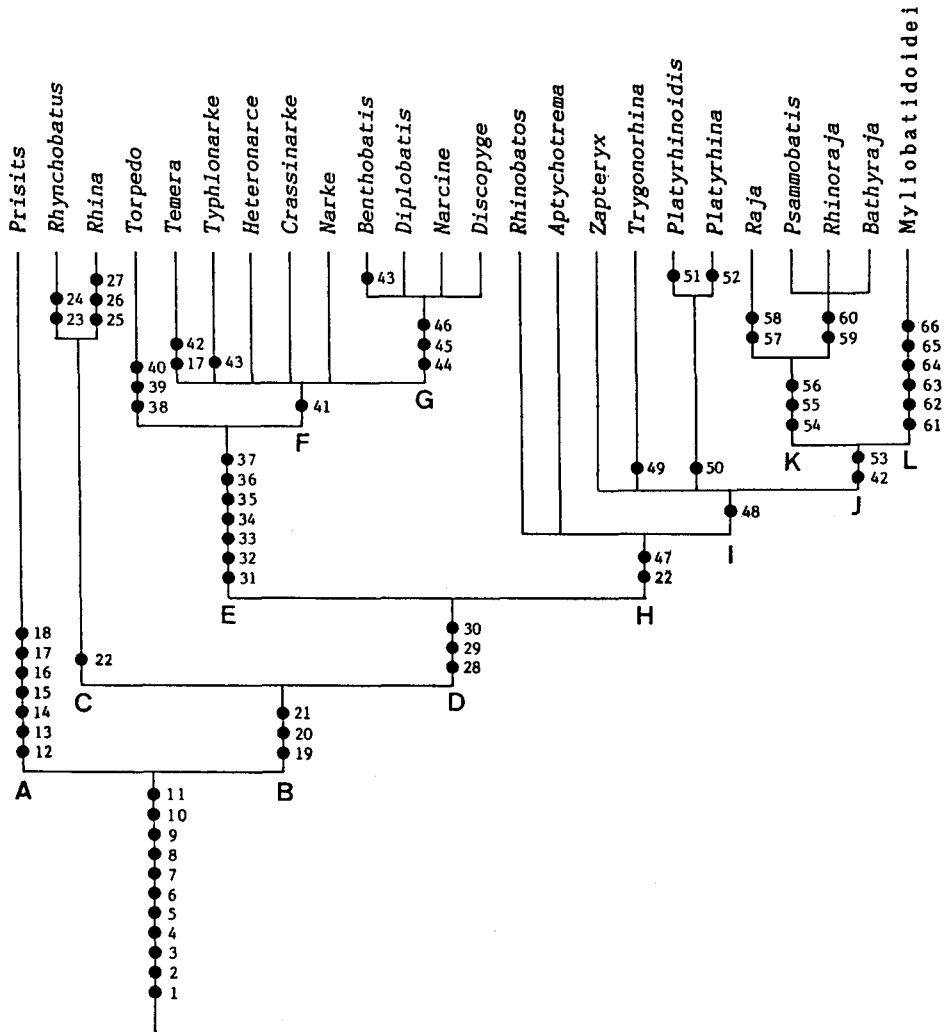

Fig. 4. Higher rajiform phylogeny representing the relationships of the Myliobatidoidei and its out-groups (see text for explanation of character states).

rajiformes or is sharks (except for pristiophoroids).

13. A collar, protecting the spinal cord, between cranium and synarcual (Compagno, 1973, 1977; Heemstra and Smith, 1980). In pristoids, a pair of collars are present on the anterior face of the synarcual, fitting into the foramen magnum. This feature is absent in other rajiformes.

14. Huge occipital condyles (Fig. 7A) (Compagno, 1973, 1977). This feature is absent in other rajiformes.

15. Hypobranchials fused into a single median plate (Compagno, 1973, 1977;

Heemstra and Smith, 1980).

16. Antorbitopectoral muscle (APM) present (Fig. 46) (Compagno, 1977). This feature is absent in other rajiformes and sharks.

17. Preorbital process (PROP) absent. This process is absent in pristoids (Fig. 7A), and the myliobatidoid genera *Rhinoptera*, *Mobula* and *Manta*, whereas it is present in other rajiformes and in most sharks. Absence of the preorbital process is therefore a derived condition. The character is also used in the myliobatidoid phylogenetic analysis (see Chapter VI).

18. Eye and spiracle wide apart. This condition is observed only in pristoids and the myliobatidoid genus *Hexatrygon*. In all other rajiform taxa, the eye and spiracle are close together. The character is also used in the myliobatidoid phylogenetic analysis (see Chapter VI).

#### Branch B

Branch B includes *Rhynchobatus*, *Rhina*, Torpedinoidei, *Rhinobatos*, *Aptychotrema*, *Zapteryx*, *Trygonorhina*, *Platyrhinoidis*, *Platyrhina*, Rajoidei and Myliobatidoidei.

19. Basal angle absent (Compagno, 1973; Heemstra and Smith, 1980).

20. Plesodic (lacking ceratotrichia) pectoral fin (Heemstra and Smith, 1980). Because the pectoral fin is aplesodic (with ceratotrichia) in both pristoids and sharks, a plesodic fin is considered to be a derived condition.

21. Plesodic pelvic fin (Heemstra and Smith, 1980). The pelvic fin is aplesodic in both pristoids and sharks.

#### Branch C

Branch C includes *Rhynchobatus* and *Rhina*.

22. Suprascapulae firmly fused to synarcual. Such fusion is not observed in pristoids or torpedinoids or in sharks, and is therefore a derived condition in rajiformes. (The condition is considered to have been independently acquired in *Rhinobatos* + *Aptychotrema* + *Zapteryx* + *Trygonorhina* + *Platyrhinoidis* + *Platyrhina* + rajoids + myliobatidoids, because this group is clearly separated from *Rhynchobatus* and *Rhina*, by having characters 28-30).

#### *Rhynchobatus*

23. Rostral foramen (RF) on dorsal surface of rostrum tip (Fig. 7B). Such a foramen is not observed in other rajiformes or in sharks.

24. Horn-like process of antorbital cartilage (Fig. 7B). This condition is not observed in other rajiformes.

#### *Rhina*

25. Suborbitalis muscle not produced into a tendon (Fig. 51B), being inserted onto the ventral surface of the mandibular cartilage. This derived condition is not observed in other rajiformes or in sharks.

26. Antorbital cartilage fused with nasal capsule (Fig. 7C). This derived condition is not observed in other rajiformes.

27. Genio-coracoideus muscle originating from pectoral girdle (Fig. 51B).

Because the genio-coracoideus muscle originates from the rectus-cervicis in most rajiformes, an origin from the pectoral girdle is considered a derived condition.

#### Branch D

Branch D includes Torpedinoidei, *Rhinobatos*, *Aptychotrema*, *Zapteryx*, *Trygonorhina*, *Platyrhinoidis*, *Platyrhina*, Rajoidei and Myliobatidoidei.

28. Pectoral propterygia and radials extending to nasal capsule (Figs. 5, 6B, C). This condition is not observed in pristoids, *Rhynchobatus* and *Rhina* or in sharks (Fig. 6A), and is derived for rajiformes.

29. Posterior corner of pectoral fin extending to pelvic fin origin. This condition is not observed in other rajiformes or in sharks, and is derived for rajiformes.

30. Caudal fin not bilobed. The caudal fin is bilobed in the pristoids (non-bilobed in several species), *Rhynchobatus* and *Rhina* and in sharks. A non-bilobed caudal fin is derived for rajiformes. (Note that the caudal fin tends to be of reduced size in rajiformes.)

#### Branch E

Branch E includes Torpedinoidei.

31. Anteriorly expanded antorbital cartilage (Compagno, 1977). This condition is observed only in the torpedinoids (Fig. 7D, E).

32. Supraorbital crests absent (Compagno, 1973, 1977; Heemstra and Smith, 1980). All other rajiformes examined in this study and most sharks, have a supraorbital crest.

33. Pectoral electric organs present (Compagno, 1973, 1977; Heemstra and Smith, 1980).

34. Coraco-hyoideus muscle absent. The coraco-hyoideus is present in other rajiformes and sharks, so its absence represents a derived condition.

35. Postorbital process reduced or absent (Fig. 7D, E, 8). It developed to a variable degree in other rajiformes (Figs. 7A-C, F-H, 10-17) and most sharks.

36. Anteriorly arched pectoral girdle. The definition of this character is modified from that of Compagno (1977), and Heemstra and Smith (1980). In the torpedinoids, the pectoral girdle is anteriorly arched, with a strut-supported posterior tube-like extension holding a rhinobatoid-like articular surface for the pectoral pterygial cartilages (Fig. 32E).

37. Nasal capsule expanded ventrolaterally. In general the nasal capsule is laterally expanded in rajiformes. In torpedinoids and myliobatidoids (except *Urotrygon daviesi* and *Hexatrygon*), however, the capsule is expanded ventrolaterally. Such an expansion of the nasal capsule is a derived condition, which Compagno (1973) regarded as a synapomorphy of the Narcinidae (*Benthobatis*, *Diplobatis*, *Discopyge* and *Narcine*). Fechhelm and McEachran (1984) followed Compagno's (1973) view. It was noted in the present study, however, that the nasal capsule expands more or less ventrolaterally in the other torpedinoids (e.g., *Narke japonica* as shown in Fig. 8). Therefore a ventrolateral expansion of the nasal capsule is considered to be a shared derived character of all torpedinoids. This character is also used in the myliobatidoid phylogenetic analysis (see Chapter VI).

*Torpedo*

38. Intermandibularis posterior muscle absent. The intermandibularis posterior muscle was present in all rajiformes examined (except *Torpedo* and *Hexatrygon*) and is also found in sharks. Its absence therefore is a derived condition in rajiformes. This character is also used in the myliobatidoid phylogenetic analysis (see Chapter VI).

39. Slender jaws (Compagno, 1973). The mandibular and palatoquadrate cartilages are especially slender in *Torpedo*, unlike other rajiformes or sharks.

40. Pinnate antorbital cartilage. This condition is not observed in other rajiformes and sharks.

## Branch F

Branch F includes *Temera*, *Typhlonarke*, *Heteronarce*, *Crassinarke*, *Narke*, *Benthobatis*, *Diplobatis*, *Narcine* and *Discopyge*.

41. Coraco-hyomandibularis muscle originated on the pectoral girdle (except in *Torpedo*; see Fig. 54). This condition is not observed in other rajiformes or in sharks.

*Temera*

17. Preorbital process absent. This character was discussed above (see page 11).

42. Dorsal fin absent (or, if present, reduced to plesodic condition). *Temera* is characterized by the absence of the dorsal fin, a derived condition in rajiformes. The dorsal fin is considered to be independently reduced in Rajoidei + Myliobatidoidei, because they form a monophyletic group.

*Typhlonarke*

43. Eye reduced and oculomotor muscle absent. This condition is observed only in *Typhlonarke* and *Benthobatis*, and may have been independently acquired in these genera, since *Benthobatis* forms a monophyletic group with *Diplobatis*, *Narcine* and *Discopyge* (Compagno, 1973; Fechhelm and McEachran, 1984; this study). Reduction of the eye is clearly a derived condition for the rajiformes.

## Branch G

Branch G includes *Benthobatis*, *Diplobatis*, *Narcine* and *Discopyge*.

44. Broad, trough- or shovel-shaped rostrum (Fig. 7D, E) (Compagno, 1973; Fechhelm and McEachran, 1984).

45. Large precerebral fossa (Compagno, 1973; Fechhelm and McEachran, 1984).

46. Last epibranchial and two posteriormost pharyngobranchial cartilages not fused. In rajiformes, these cartilages are generally fused, but in the torpedinoid genera *Benthobatis*, *Diplobatis*, *Narcine* and *Discopyge*, and also in *Urotrygon daviesi* (Myliobatidoidei), these cartilages articulate with each other (Fig. 29A). This condition, which is derived for rajiformes, is also used in the myliobatidoid phylogenetic analysis (see Chapter VI).

*Benthobatis*

43. Eye reduced and oculomotor muscle absent. This character was discussed above (see page 13).

## Branch H

Branch H includes *Rhinobatos*, *Aptychotrema*, *Zapteryx*, *Trygonorhina*, *Platyrrhinoidis*, *Platyrrhina*, Rajoidei and Myliobatidoidei.

22. Suprascapulae fused to synarcual. This character was discussed above.

47. Lateral articulation between antorbital cartilage and pectoral propterygium. The antorbital cartilage gives direct, lateral support to the pectoral propterygium in this group (Figs. 5, 6B, C), a condition not observed in other rajiform taxa (Fig. 6A) or in sharks.

## Branch I

Branch I includes *Zapteryx*, *Trygonorhina*, *Platyrrhinoidis*, *Platyrrhina*, Rajoidei and Myliobatidoidei.

48. Pectoral propterygia and radials extending far beyond nasal capsule (Fig. 6C) is not observed in other rajiform taxa (Fig. 6A, B) or in sharks.

*Trygonorhina*

49. Nasal curtain completely united, reaching mouth. This condition is observed in both *Trygonorhina* and myliobatidoids (except *Urotrygon daviesi* and *Hexatrygon*). In other rajiform taxa the united nasal curtain is absent (Fig. 57C) or, if present, not so well developed. A well developed nasal curtain is a derived condition for rajiformes. The character is also used in the myliobatidoid phylogenetic analysis (see Chapter VI).

*Platyrrhinoidis* and *Platyrrhina*

50. Postpelvic process present (Fig. 36Q), a derived condition for rajiformes.

*Platyrrhinoidis*

51. Anteriorly directed, plate-like cartilage (PC) present, in association with rostral (Fig. 7G). This is not observed in other taxa, the state being derived for rajiformes.

*Platyrrhina*

52. Bar-like cartilage (BC) attached to rostrum (Fig. 7H).

## Branch J

Branch J includes Rajoidei and Myliobatidoidei.

42. Dorsal fin absent or, if present, reduced to plesodic condition. This character was discussed above (see page 13).

53. Caudal fin reduced to plesodic condition, tail folds or absent. This condition is observed in both rajoids and myliobatidoids. The caudal fin is well developed and aplesodic in other rajiform taxa. Reduction of the caudal fin is a derived condition for rajiformes.

## Branch K

Branch K includes Rajoidei.

54. Pelvic fin with a prominent, more or less separate, anterior lobe (Compagno, 1973; Heemstra and Smith, 1980).

55. A forked anterior projection of basibranchial cartilage (Fig. 28E) (Compagno, 1973).

56. Caudal fin reduced to tail folds or absent. In both rajoids and myliobatidoids (except *Urotrygon*, *Hexatrygon* and *Urolophus*), the caudal fin is reduced to tail folds or is absent. This character is also used in the myliobatidoid phylogenetic analysis (see Chapter VI).

*Raja*

57. Scapulocoracoids without anterior bridge (Fig. 32C) (McEachran, 1984).

58. Scapulocoracoid with an enlarged postdorsal fenestra (Fig. 32C) (McEachran, 1984).

## Branch L

Branch L includes *Bathyraja*, *Rhinoraja* and *Psammobatis*.

59. Rostral shaft slender and usually segmented basally (McEachran, 1984).

60. Anterior fontanelle broad and extending little if at all anterior to leading edge of nasal capsules (McEachran, 1984).

## Myliobatidoidei

61. Ventral pseudohyoid bar proximally fused with 1st ceratobranchial cartilage (Figs. 27, 28). Fusion of these cartilages is not observed in other taxa, and represents a derived state for rajiformes.

62. Levator rostri muscle absent (Fig. 45), a derived condition for rajiformes.

63. Socket and condyle articulation between synarcual and scapular cartilage (Compagno, 1973, 1977; Heemstra and Smith, 1980).

64. Loss of ribs (Figs. 38, 39).

65. Postorbital process very wide and flat (Figs. 10-17) (Compagno, 1973, 1977; Heemstra and Smith, 1980).

66. Second synarcual present (Compagno, 1973, 1977; Heemstra and Smith, 1980).

## 3. Discussion

As summarized by Seret (1986), there are several competing hypotheses on higher rajiform phylogeny. The phylogeny represented in Fig. 4 also differs from those of former studies. Pristoids are considered to be the sister group of all other rajiformes, although Compagno (1977) and Maisey (1984a) considered the torpedinoids as the most plesiomorphic living rajiformes, citing a single synapomorphy (the loss of a relationship between the hyomandibular and ceratohyoid cartilages) as uniting all rajiformes except torpedinoids. In this study also, the retaining of such a relationship is observed in several torpedinoid taxa (i.e., *Typhlonarke*, *Crassinarke* and *Narke*), whereas all other rajiformes have lost it. This character, however, is in conflict with the following three characters which are shared by all rajiformes except

pristoids: 19 (basal angle absent), 20 (plesodic pectoral fin) and 21 (plesodic pelvic fin). These characters support the monophyly of the rajiformes (excepting pristoids), and indicate that the most plesiomorphic rajiformes are the pristoids, and not the torpedinoids. This supports Compagno's earlier (1973) view, which is also supported by Heemstra and Smith (1980) and Dingerkus (pers. comm., 1985). The next most plesiomorphic group comprises the genera *Rhynchobatus* and *Rhina*, which are currently included in the suborder Rhinobatoidei. Heemstra and Smith (1980) considered the rhinobatoids to be a monophyletic group, and the sistergroup of the suborder Rajoidei, but with little supporting evidence. This study, however, shows that the Rhinobatoidei is not a monophyletic group. *Rhynchobatus* and *Rhina* are united solely by character 22, which is also shared by *Rhinobatos*, *Aptychotrema*, *Zapteryx*, *Trygonorhina*, *Platyrrhinoidis*, *Platyrrhina*, the Rajoidei and the Myliobatidoidei, but the two former genera lack character 47 which is shared by the others. *Rhynchobatus* and *Rhina* also lack the three synapomorphic characteristics (28-30) of the Torpedinoidei, Rajoidei and Myliobatidoidei, and the genera *Rhinobatos*, *Aptychotrema*, *Zapteryx*, *Trygonorhina*, *Platyrrhinoidis*, *Platyrrhina*. Therefore *Rhynchobatus* and *Rhina* are tentatively classified as next most plesiomorphic rajiformes. The torpedinoids are the next branched monophyletic group, sharing seven apomorphic characters 31-37. The interrelationships of this group, however, cannot be well resolved, because there are few shared, derived characters, as mentioned by Fechhelm and McEachran (1984). Members of the Narcinidae and Narkidae (*sensu* Compagno, 1973) form a monophyletic group by virtue of sharing a synapomorphic character 41 (coraco-hyomandibularis muscle inserted on the pectoral girdle). However, at lower level, monophyly within the Narkidae cannot be confirmed, whereas monophyly of the Narcinidae (Compagno, 1973; Fechhelm and McEachran, 1984) is confirmed by the three synapomorphic characters 44-46. The sister group relationship between *Narcine* and *Discopyge* proposed by Fechhelm and McEachran (1984) is not adopted here for the following reason. The well developed iliac process of *Discopyge* is similar to that found in *Typhlonarke*, *Crassinarke*, *Temera*, *Heteronarce* and *Narke*, whereas the process is not so well developed in *Narcine brasiliensis*, *N. maculata* and *N. timlei*. A postlateral process on the antorbital cartilage is present in *Discopyge*, *Narcine brasiliensis*, *N. timlei* and *Heteronarce*, but absent in *Narcine maculata*. Accordingly these two characters cannot be synapomorphies of *Narcine* and *Discopyge*, as proposed by Fechhelm and McEachran (1984). The remaining rajiform members form a monophyletic group by virtue of sharing two apomorphic characters, 22 (suprascapulae fused to synarcual) and 47 (lateral articulation between antorbital cartilage and pectoral propterygium). In former studies (Compagno, 1977; Heemstra and Smith, 1980; Maisey, 1984a), rhinobatoids + rajoids + myliobatidoids have been considered to be a monophyletic group. This study, however, shows that the group cannot be monophyletic unless *Rhynchobatus* and *Rhina* are excluded. The relationships of genera currently included in the Rhinobatoidei remain unresolved owing to a lack of shared derived characters. On the other hand, *Zapteryx*, *Trygonorhina*, *Platyrrhinoidis* and *Platyrrhina*, form a monophyletic group together with the rajoids and myliobatidoids. Monophyly of this group is supported by apomorphic character 48 (pectoral radials extending far beyond nasal capsule). On radiographic evidence, the genus

*Zanobatus* may also be included in this group. *Platyrrhinoidis* and *Platyrrhina* share apomorphic character 50, and are sister groups. The Rajoidei and Myliobatidoidei are also considered to be sister groups because of their sharing of two apomorphic characters 42 (dorsal fin absent or, if present, reduced to plesodic condition) and 53 (caudal fin reduced to plesodic condition, tail folds, or absent). The suborder Rajoidei is considered to be a monophyletic group characterised by three apomorphic conditions, 54-56. In this study, rajoid interrelationships are based on the study of McEachran (1984). *Psammobatis*, *Rhinoraja* and *Bathyraja* form a monophyletic group, sharing two apomorphic characters, 59 and 60, and are the sister-group of *Raja*. The suborder Myliobatidoidei is considered to be a monophyletic group having six apomorphic characters, 61-66. Monophyly of the myliobatidoids is discussed in Chapter VII.

## VI. Comparative morphology and character analysis

In this chapter, skeletons, muscles and other body parts of the Myliobatidoidei are described. For each character, phylogenetic significance is discussed, and polarity determined.

### 1. Skeletons of the Myliobatidoidei

#### 1) Neurocranium

*Description.* In myliobatidoids, the neurocranium is a flattened, box-like structure, containing the brain, olfactory organs and auditory organs. The space between the nasal and auditory capsules on each side represents the orbit. The neurocranium differs in its rigidity. In *Hexatrygon longirostra* and *Urotrygon daviesi* the neurocranium is characterised by relatively soft cartilage. In other myliobatidoids, it is strengthened by calcium deposition.

The rostrum (RS) is the anteriormost part of the neurocranium and supports the

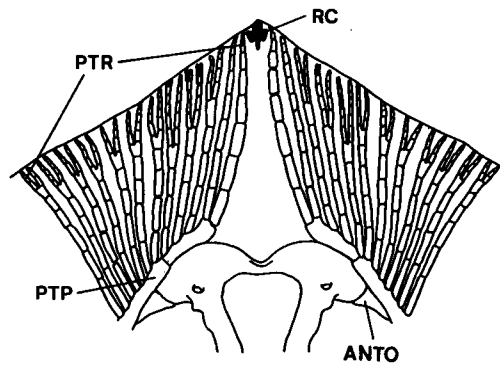

Fig. 5. Dorsal view of the snout of *Urotrygon microphthalmum* (NSMT-P 40561). ANTO, antorbital cartilage; PTP, pectoral propterygium; PTR, pectoral radials; RC, rostral cartilage. Scale indicates 10 mm.

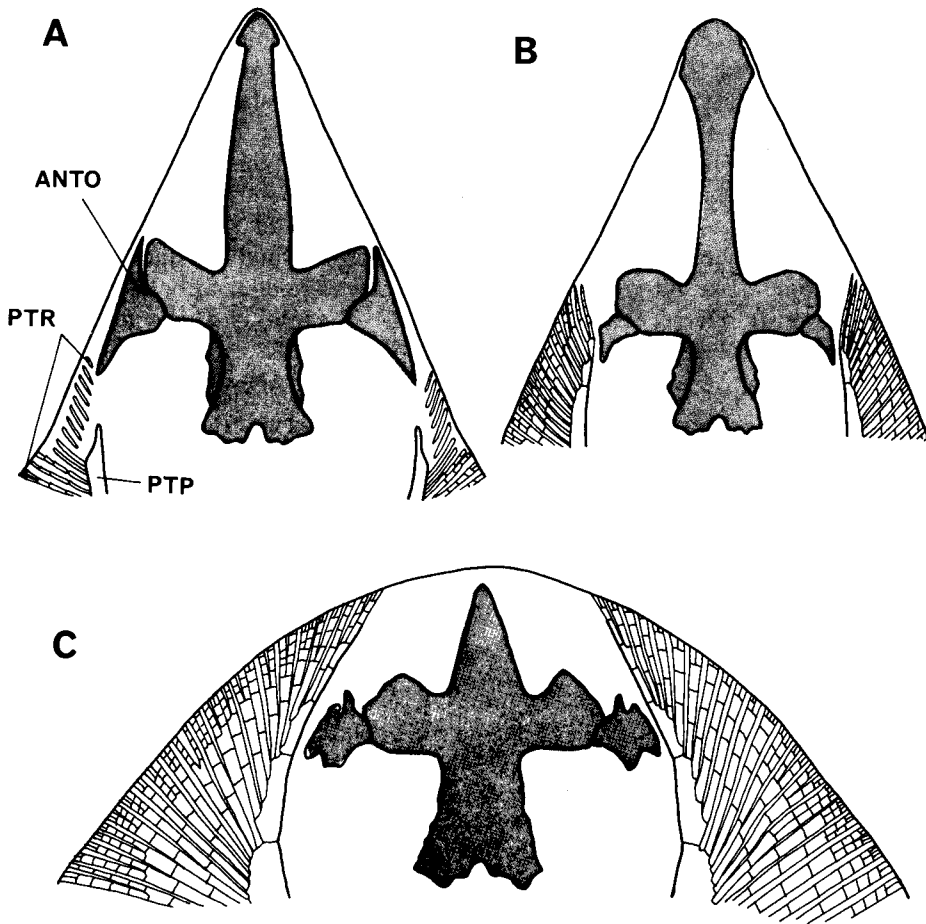

Fig. 6. Relationship between neurocranium and pectoral propterygia and radials in myliobatidoids. A, pectoral propterygia and radials not extending to nasal capsule; B, propterygia and radials extending as far as nasal capsule; C, pectoral propterygia and radials extending far beyond nasal capsule. ANTO, antorbital cartilage; PTP, pectoral propterygium; PTR, pectoral radial.

snout in most rajiformes (Fig. 7). However, it is absent in myliobatidoids (Figs. 10-17) except on occasion in *Urotrygon microphthalmum*. Although absent in one example of the latter (NSMT-P 40562), the distal tip of the rostrum (rostral cartilage: RC) remained separate from the neurocranium in a second specimen (NSMT-P 40561) (Fig. 5).

The nasal capsule (NC) is relatively thin-walled, forming the anterior part of the neurocranium. The capsules are more or less globe-like bulges, which encase the olfactory organs. Each capsule is expanded ventrolaterally in most myliobatidoids (most strongly expanded in *Rhinoptera*, *Mobula* and *Manta*). In *Urotrygon daviesi*

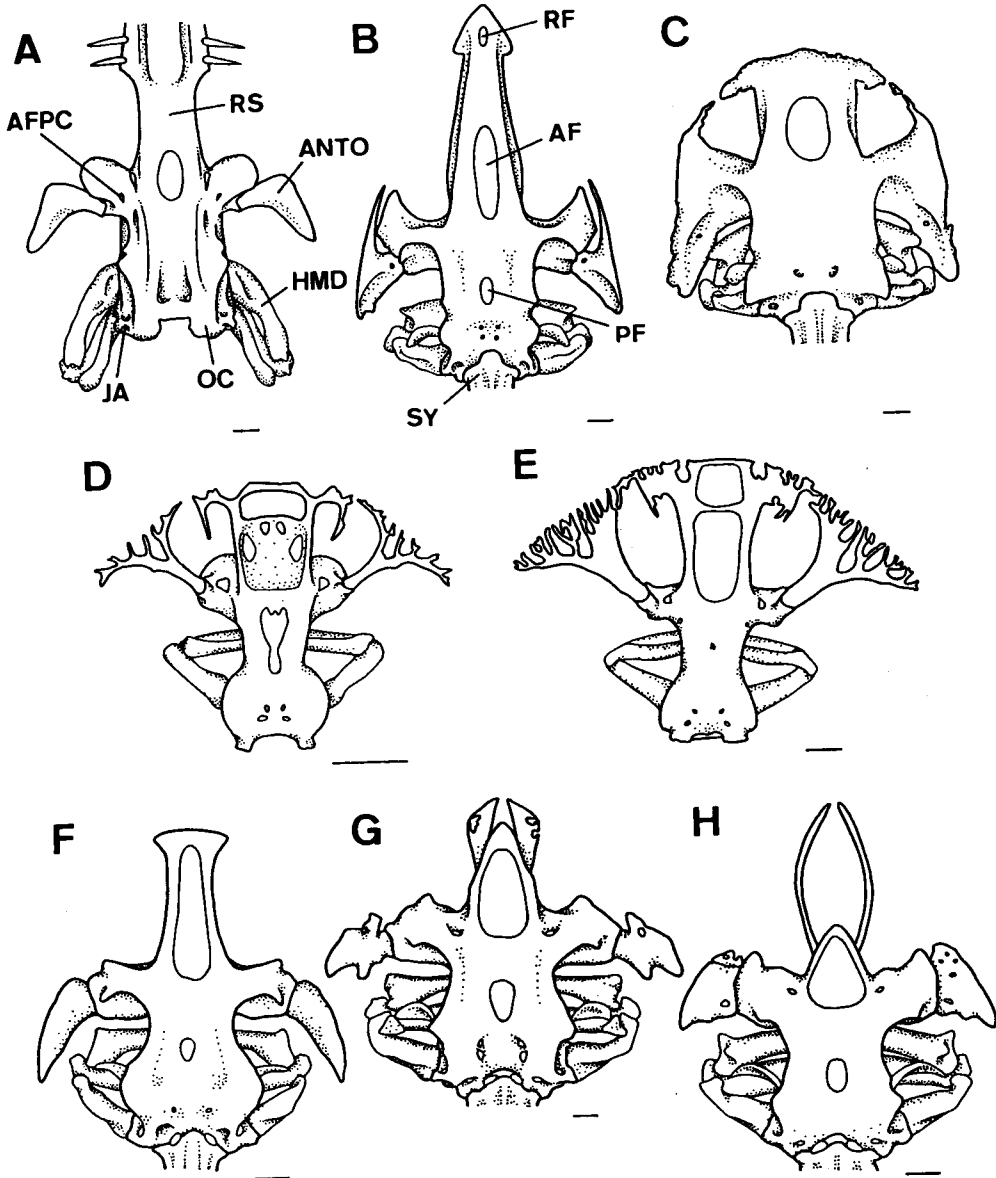

Fig. 7. Dorsal view of the neurocrania of myliobatoid out-groups. A, *Pristis*; B, *Rhynchobatus*; C, *Rhina*; D, *Diplobatis*; E, *Narcine*; F, *Zapteryx*; G, *Platyrhinoidis*; H, *Platyrhina*. AF, anterior fontanelle; AFPC, anterior foramen for preorbital canal; ANTO, antorbital cartilage; BC, bar-like cartilage; FA, foramen on rostrum tip; HMD, hyomandibular cartilage; HPA, horn-like process of antorbital cartilage; JA, jugal arch; OC, occipital condyle; PC, plate-like cartilage; PF, posterior fontanelle; POP, postorbital process; RS, rostrum; SY, synarcual. Scales indicate 10 mm.

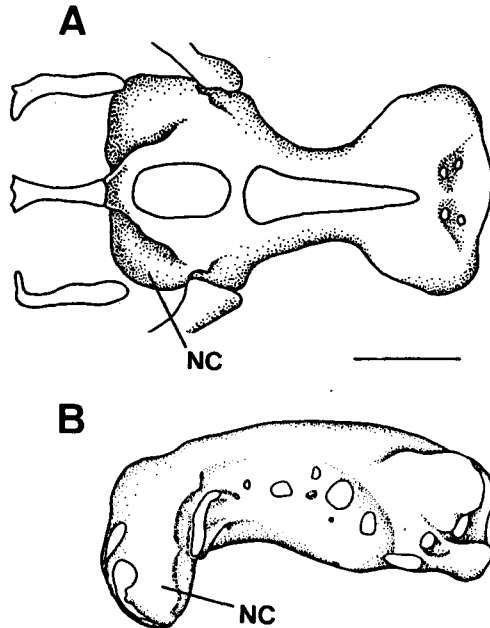

Fig. 8. Neurocranium of *Narke japonica*. A, dorsal view; B, lateral view. NC, nasal capsule. Scale indicates 10 mm.

(Figs. 10, 18A) and *Hexatrygon longirostra* (Fig. 11), however, it is expanded laterally. In skates and rays, the nasal capsule opens ventrally, usually with three nasal cartilages present on the margin of the opening (Fig. 9). These cartilages, inner nasal cartilage (INC), outer nasal cartilage (ONC) and posterior nasal cartilage (PNC), reinforce the nasal flaps. In the myliobatidoids examined in this study (Figs. 9A-C), both outer and posterior nasal cartilages are present, although variable in shape, and the inner nasal cartilage is fused to the nasal capsule. Both sides of nasal capsules are separated by an internal septum. The internarial region is usually narrow in myliobatidoids, but has considerable width in *Hexatrygon*, *Rhinoptera* (Fig. 17A), *Mobula* (Fig. 17B) and *Manta*.

In *Rhinoptera* (Figs. 17A, 19E), *Mobula* (Figs. 17B, 19F) and *Manta*, the anterolateral margins of the neurocranium extended anteriorly over the nasal capsules. These paired "eave-like" processes are herein called the "anterior process(es) of the neurocranium (APN)". Ventrally, such processes support the cephalic fins. In *Rhinoptera*, *Mobula* and *Manta*, the neurocranium is bordered anteroventrally by the front wall of the nasal capsules, and dorsally by the anterior processes of the neurocranium (Fig. 19E, F). The latter processes are absent in other myliobatidoid genera, and in these taxa, the neurocranium is bordered anteriorly by the front wall of the nasal capsules (Figs. 18, 19A-D). In most myliobatidoids, the anterior margins of the snout are supported by the pectoral propterygia and radials. Masses of ampullae of Lorenzini are generally supported by the pectoral propterygia and anterior surface of the neurocranium. In *Mobula*

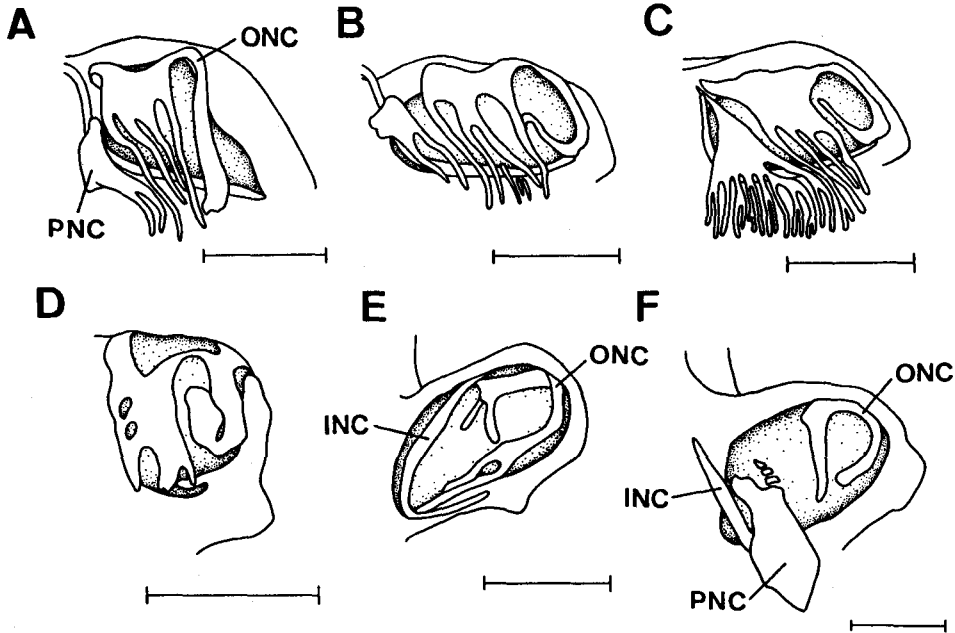

Fig. 9. Ventral view of the nasal capsule. A, *Potamotrygon yepezi*; B, *Dasyatis akajei*; C, *Myliobatis tobijei*; D, *Narke japonica*; E, *Rhinobatos hynnicephalus*; F, *Raja pulchra*. INC, inner nasal cartilage; ONC, outer nasal cartilage; PNC, posterior nasal cartilage. Scales indicate 10 mm.

(Fig. 17B) and *Manta*, however, owing to modification of the pectoral fin to a cephalic fin, the snout is supported by the anterodorsal margin of the neurocranium.

A condyle for articulation with the antorbital cartilage is located on the posterolateral corner of the nasal capsule. In all myliobatidoids, the antorbital cartilage (ANTO) is platelike, and laterally supports the pectoral propterygia (Figs. 5, 10-16).

The orbital region, containing the eyeballs, is bordered anteriorly by the posterior wall of the nasal capsule, dorsally by the supraorbital crest, ventrally by the basal plate, and posteriorly by the anterior wall of the otic capsule. Above the condyle for the antorbital cartilage, the preorbital process (PROP), in most myliobatidoids, is well developed, protruding posterolaterally. However, it is not developed in *Rhinoptera* (Fig. 17A), *Mobula* (Fig. 17B) or *Manta* (Fig. 17). The supraorbital crest (SOC) originates from the base of the preorbital process, and extends posteriorly to end at the base of the postorbital process. It was present in all of the myliobatidoids examined in this study. In other taxa examined, the crest was also present, except in the Torpedinoidei (Fig. 7D, E).

The interorbital region is usually flat and narrow (interorbital width narrower than neurocranium length) in myliobatidoids and out-groups, but is particularly wide (interorbital width wider than neurocranium length) in *Mobula* (Fig. 17B) and *Manta*. In *Urotrygon* (Figs. 10, 12B), *Hexatrygon* (Fig. 11), *Urolophus* (Fig. 12A),

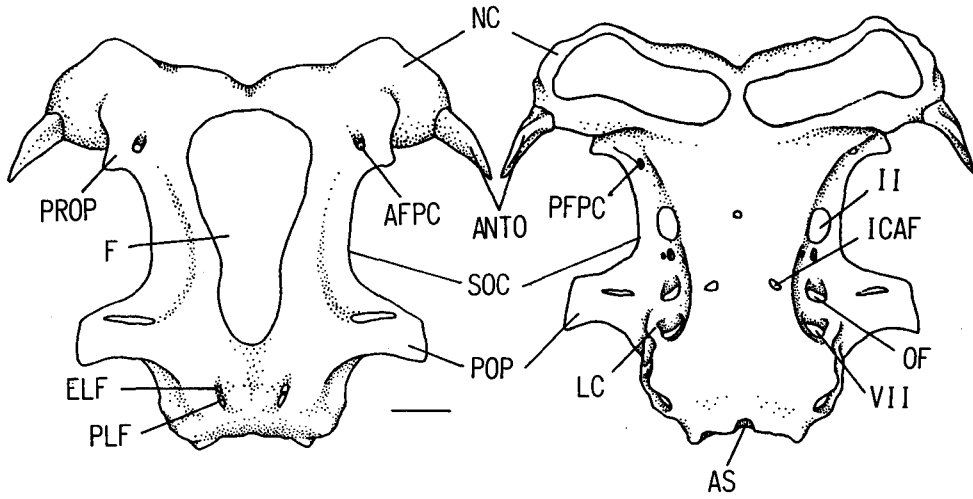

Fig. 10. Dorsal (left) and ventral (right) views of the neurocranium of *Urotrygon daviesi*. AFPC, anterior foramen for preorbital canal; ANTO, antorbital cartilage; AS, articular surface for synarcual; ELF, endolymphatic foramen; F, fontanelle; ICAF, internal carotid artery foramen; LC, lateral commissure; LF, lymphatic foramen; NC, nasal capsule; OF, orbital fissure; PFPC, posterior foramen for preorbital canal; PLF, perilymphatic foramen; POP, postorbital process; PROP, preorbital process; SOC, supraorbital crest; II, optic nerve foramen; VII, hyomandibular branch of facial nerve foramen. Scale indicates 10 mm.

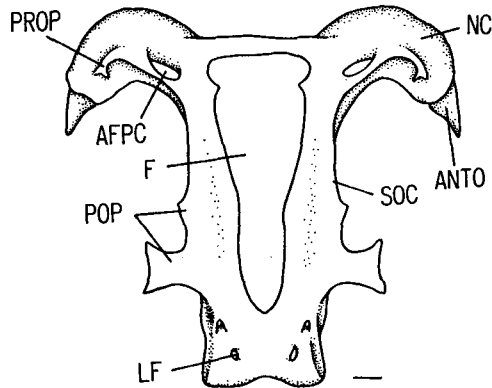

Fig. 11. Dorsal view of the neurocranium of *Hexatrygon longirostra*. For abbreviations, see Fig. 10. Scale indicates 10 mm.

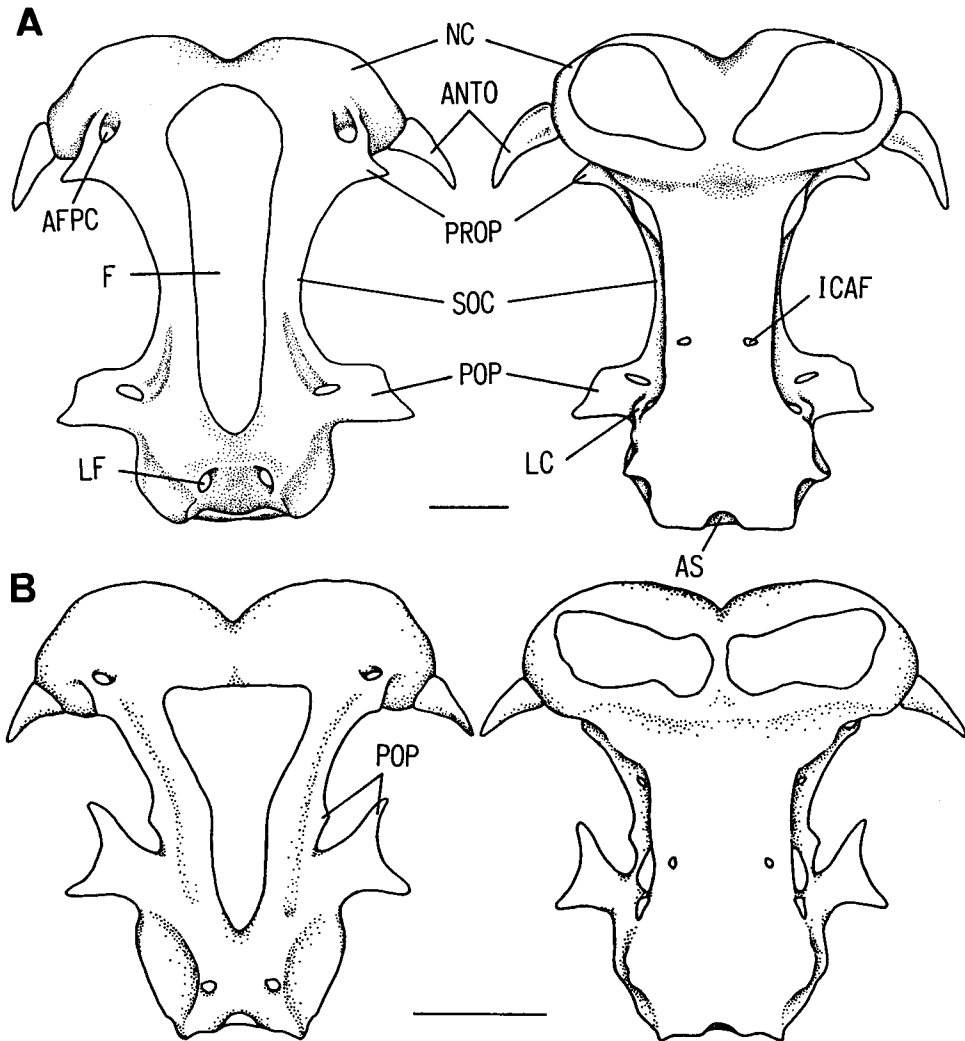

Fig. 12. Dorsal (left) and ventral (right) views of the neurocranium. A, *Urolophus aurantiacus*; B, *Urotrygon microphthalmum*. For abbreviations, see Fig. 10. Scales indicate 10 mm.

*Potamotrygon* (Fig. 13A), *Taeniura* (Fig. 13B), *Dasyatis* (Fig. 14A) and *Himantura* (Fig. 14B), laterally produced postorbital processes (POP) are located on the dorsolateral corners of the otic region, but they are more anteriorly located in *Gymnura* (Fig. 15A), *Aetoplatea* (Fig. 15B), *Myliobatis* (Fig. 16A), *Aetomylaeus* (Fig. 16B), *Aetobatus*, *Rhinoptera* (Fig. 17A), *Mobula* (Fig. 17B) and *Manta*. In most myliobatidoids, the postorbital process comprises two parts; a small triangular anterior section and an expanded plate-like posterior section. These two sections are secondarily distally fused in *Aetobatus*, *Aetomylaeus*, *Rhinoptera*, *Mobula*,

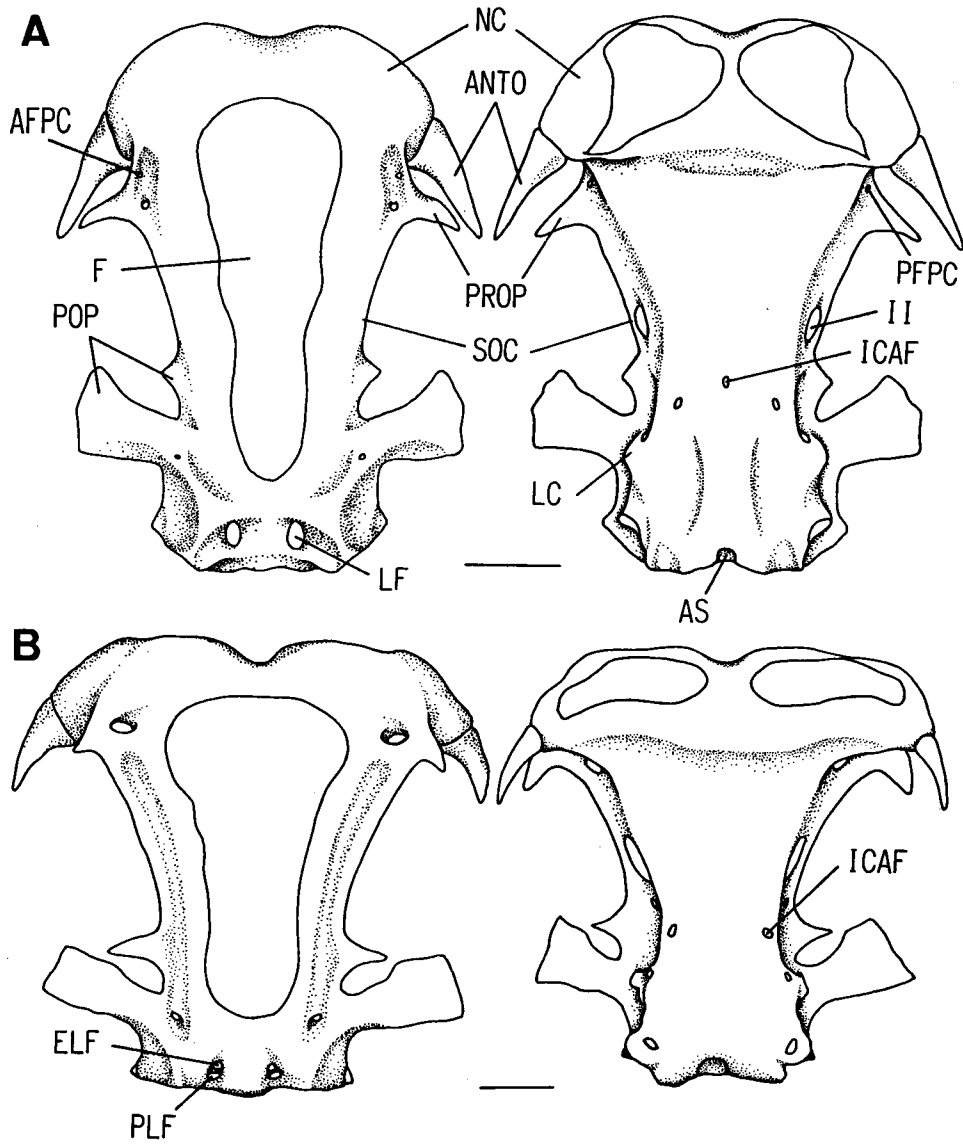

Fig. 13. Dorsal (left) and ventral (right) views of the neurocranium. A, *Potamotrygon yepesi*; B, *Taeniura meyeni*. For abbreviations, see Fig. 10. Scales indicate 10 mm.

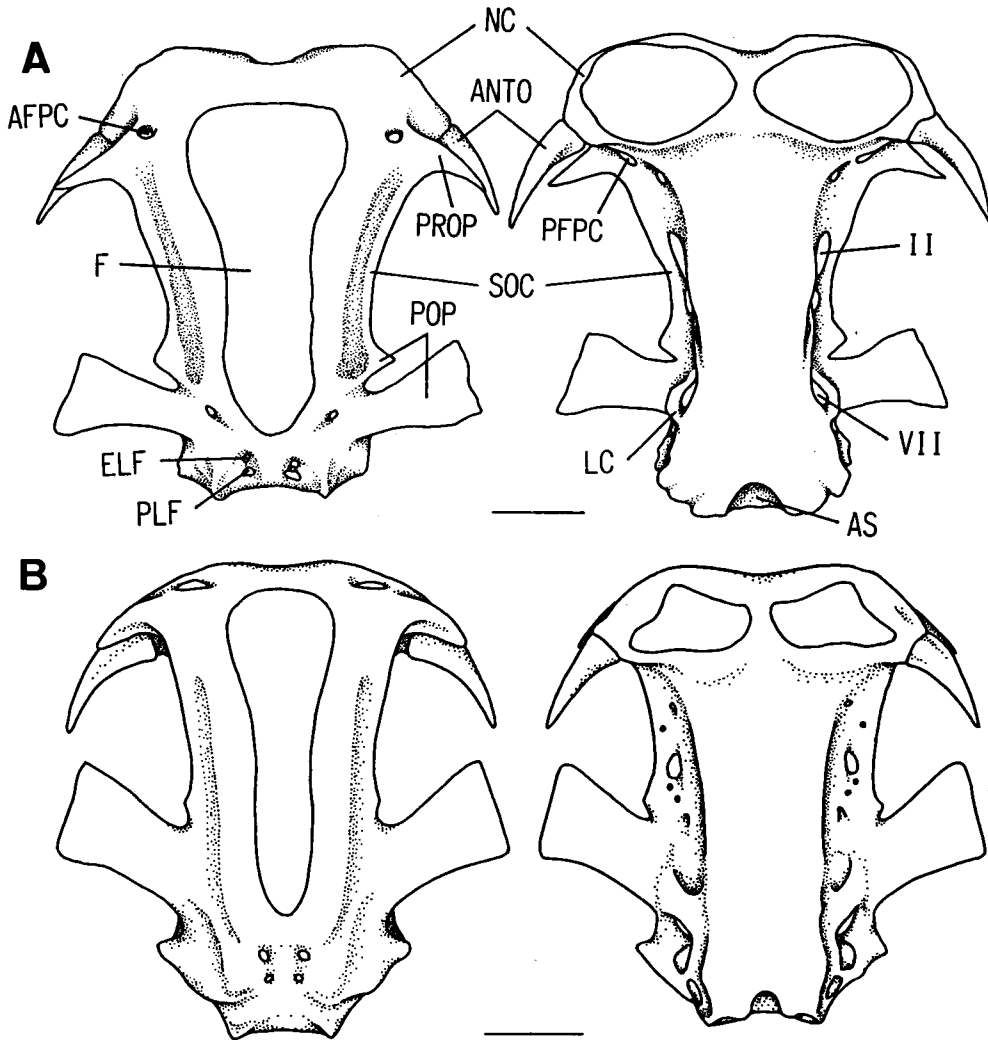

Fig. 14. Dorsal (left) and ventral (right) views of the neurocranium. A, *Dasyatis akajei*; B, *Himantura bleekeri*. For abbreviations, see Fig. 10. Scales indicate 10 mm.

*Manta* and several species of *Urolophus* and *Urotrygon* (Figs. 10, 12, 16B, 17). In all these taxa, a large foramen gives evidence of the fusion of the anterior and posterior postorbital sections. In *Aetobatus*, *Rhinoptera*, *Mobula* and *Manta*, the lateral margin of the postorbital process is bar-like, protruding ventrally (Figs. 17, 19E, F). This condition is not observed in other myliobatidoids. Postorbital processes are present in all taxa, excepting torpedinoids.

Anterior and posterior fontanelles, openings of the cerebral cavity, are present on the roof of the neurocranium. Those fontanelles are usually separated in raji-

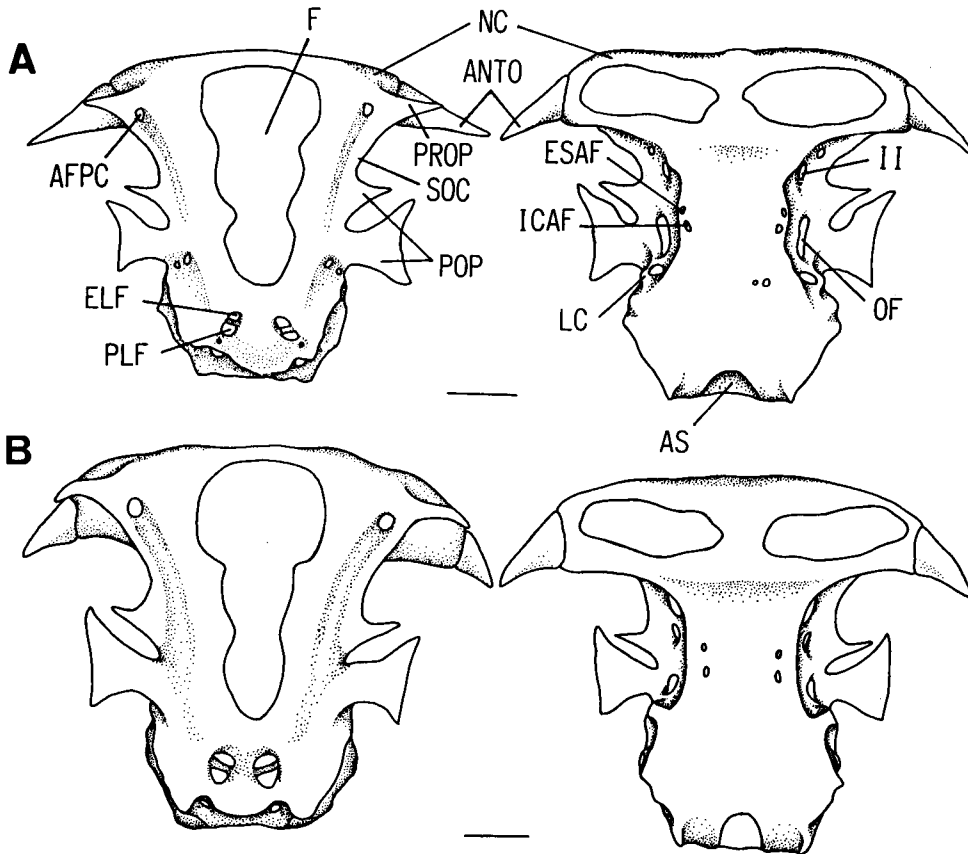

Fig. 15. Dorsal (left) and ventral (right) views of the neurocranium. A, *Gymnura japonica*; B, *Aetoplatea zonura*. For abbreviations, see Fig. 10. Scales indicate 10 mm.

formes (Figs. 7, 8), but are continuous in the Myliobatidoidei (Figs. 10-17). The myliobatidoid fontanelle (F) is sealed by a strong membrane, and although variable in shape, is generally oval, narrowing posteriorly.

In most myliobatidoids, two pairs of lymphatic foramina (LF), the anteriorly located endolymphatic foramen (ELF) and the posteriorly located perilymphatic foramen (PLF), are present on the dorsal surface of the otic region. In some species of *Hexatrygon* (Fig. 11), *Urolophus* (Fig. 12A), *Urotrygon* (Fig. 12B), *Potamotrygon* (Fig. 13A), *Dasyatis*, *Himantura*, *Taeniura*, *Gymnura* and *Aetoplatea*, however, only a single pair of lymphatic foramina is present.

The eye stalk (ES), is a goblet-like, shaft, extending from the lateral wall of the orbit just behind the optic nerve foramen (II). It is present in all myliobatidoids (Figs. 18, 19) and most out-group taxa. In the out-group genera, *Typhlonarke* and *Discopyge*, which have no eyes, the eye stalk is reduced to a small, ball-like cartilage.

Paired otic capsules are located posterior to the orbital region. Each capsule is

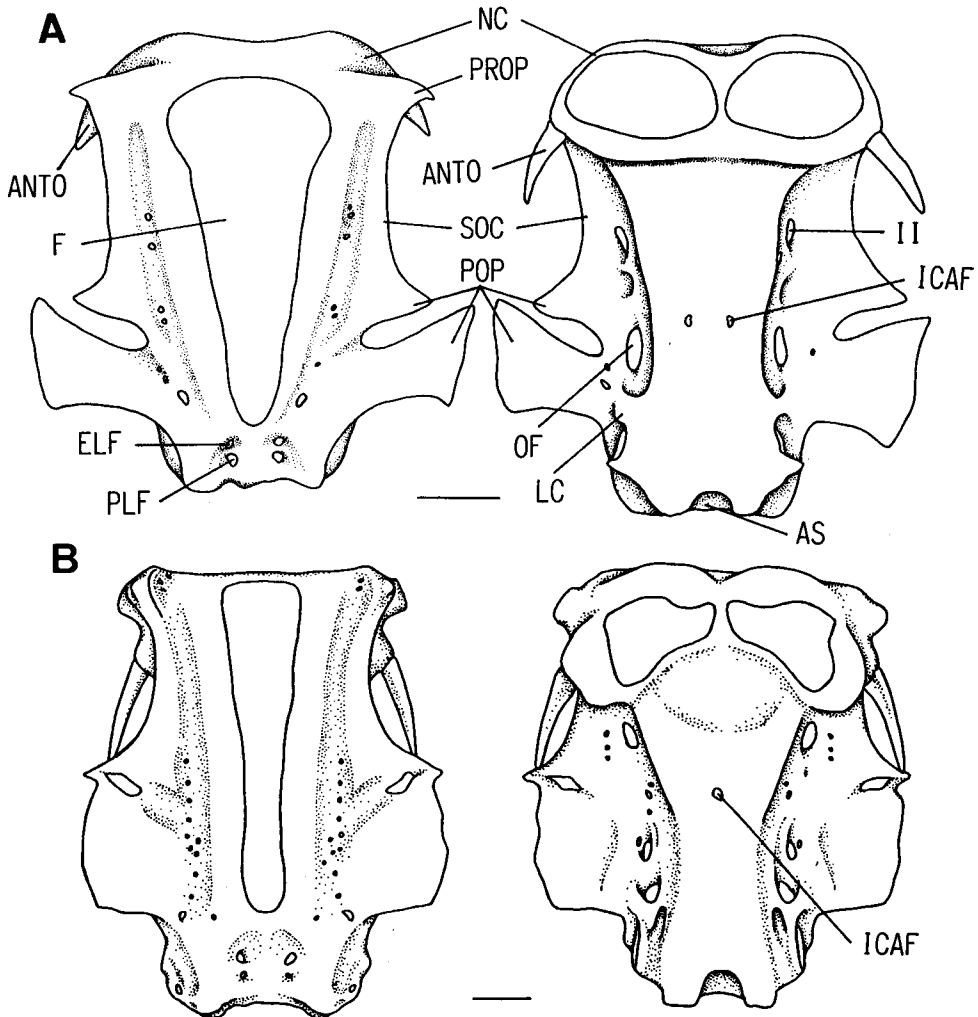

Fig. 16. Dorsal (left) and ventral (right) views of the neurocranium. A, *Myliobatis tobijei*; B, *Aetomylaeus nichofii*. For abbreviations, see Fig. 10. Scales indicate 10 mm.

box shaped and contains the auditory organ. On the lateral wall of the capsule, near the border of the orbital and otic regions, a bridge-like, lateral commissure (LC) is located just over the hyomandibular branch of facial nerve foramen (VII). The commissure is present in all myliobatidoids (Figs. 18, 19) and in most out-group taxa, but is usually absent in sharks (Compagno, 1988).

The hyomandibular facet (HMDF), dorsal pseudohyoid bar facet (DPBF), and 1st epibranchial cartilage facet are located on the ventrolateral corner of the otic region. Those facets are shallow depressions and are usually oval, lying horizon-

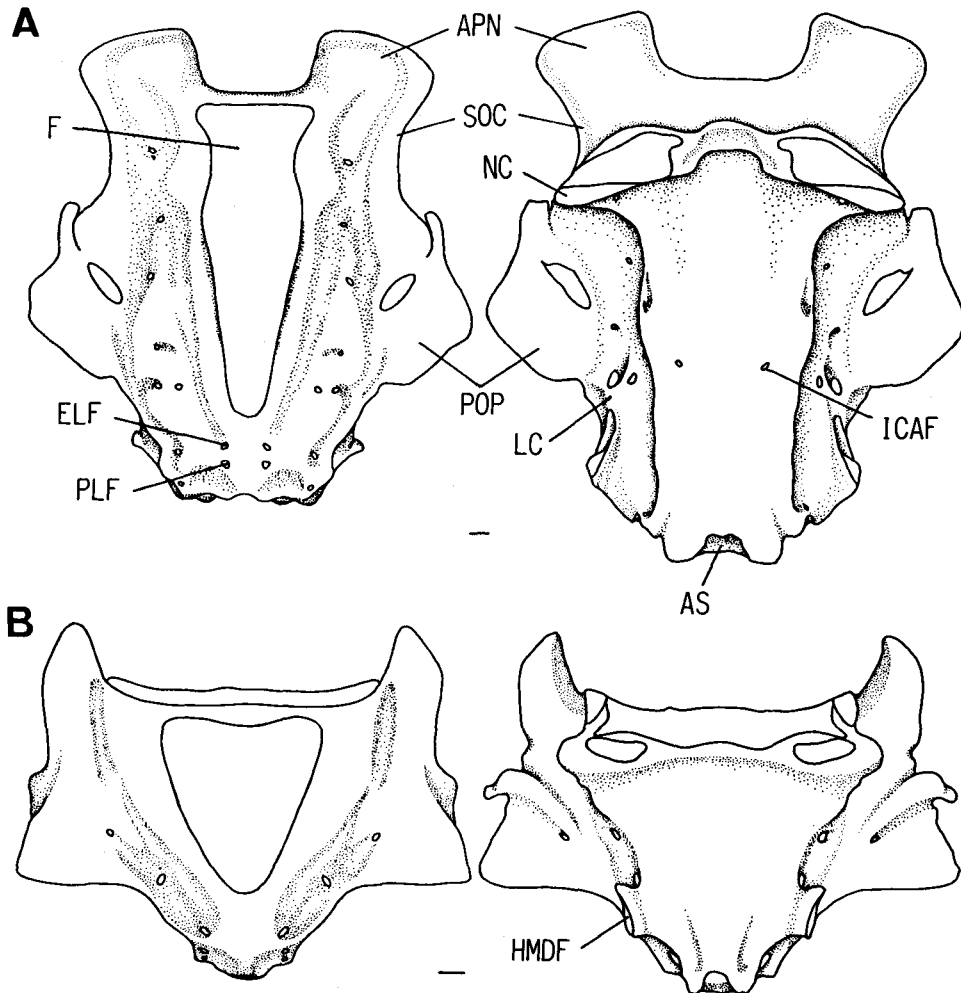

Fig. 17. Dorsal (left) and ventral (right) views of the neurocranium (antorbital cartilage removed). A, *Rhinoptera javanica*; B, *Mobula japonica*. APN, anterior process of neurocranium; HMDF, hyomandibular facet. For other abbreviations, see Fig. 10. Scales indicate 10 mm.

tally.

A jugal arch (JA) is absent in all of the myliobatidoids examined here. Such an arch is present in the pristoids, rhinobatoids and rajoids, but is absent in torpedinoids (Figs. 7, 8).

The occipital region forms the posteriormost part of the neurocranium. Below the foramen magnum (FM) on the posteroventral surface of the neurocranium, an articular surface (AS) and a pair of occipital condyle (OC) for articulation with the synarcual, are located (Figs. 18, 19). The articular surface is a semicircular notch of

the basal plate of the neurocranium. The occipital condyles are situated on either side of the articular surface.

The basal plate, forming the neurocranium floor, is usually flat.

There are many foramina in the neurocranium for arteries and nerves which enter or leave the brain. They are as follows:

**Preorbital canal foramen:** In most myliobatidoids, the anterior foramen for the preorbital canal (AFPC) is located dorsally at the base of the preorbital process (Figs. 10-15), but is located on the anterior surface of the neurocranium in *Myliobatis*, *Aetobatus*, *Aetomylaeus*, *Rhinoptera*, *Mobula* and *Manta*. The posterior foramen for the preorbital canal (PFPC) is located dorsally at the junction of the nasal capsule and orbit (Figs. 18, 19), and is occupied by a branch of the facial nerve (VII). In all myliobatidoids and most out-groups examined, preorbital canal foramina are present.

**Anterior cerebral vein foramen (ACVF):** Located anterodorsally to the optic nerve foramen (Figs. 18, 19).

**Orbital nasal canal foramen (V):** Located below the posterior foramen for the preorbital canal (Figs. 18, 19).

**Optic nerve foramen (II):** Located centrally on the orbital wall just anterior to the base of the eye stalk (Figs. 18, 19). It is the largest foramen in this region.

**Trochlear nerve foramen (IV):** Located posterodorsally to the optic nerve foramen (Figs. 18, 19).

**Oculomotor nerve foramen (III):** Located just dorsally to the base of the eye stalk (Figs. 18, 19).

**Efferent spiracular artery foramen (ESAF):** Located posteroventrally to the base of the eye stalk (Figs. 18, 19).

**Interorbital vein foramen (IVF):** Located posteriorly to the base of the eye stalk (Figs. 18, 19).

**Orbital fissure (OF):** A large foramen, located at the junction of the orbit and otic capsule (Figs. 18, 19).

**Hyomandibular branch of facial nerve foramen (VII):** Located posteroventrally to the orbital fissure, just below the lateral commissure (Figs. 18, 19).

**Posterior cerebral vein foramen (PCVF):** Located at the junction of the lateral and posterior surfaces of the neurocranium (Figs. 18, 19).

**Glossopharyngeal nerve foramen (IX):** Located on the posterior surface of the neurocranium, dorsolaterally to the occipital condyle (Figs. 18, 19).

**Foramen magnum (FM):** Located on the center of the posterior surface of the neurocranium (Figs. 18, 19). The spinal cord foramen.

**Vagus nerve foramen (X):** Located just laterally to the foramen magnum (Figs. 18, 19).

**Lateralis branch of vagus nerve foramen (LbX):** Located dorsolaterally to the vagus nerve foramen (Figs. 18, 19).

**Internal carotid artery foramen (ICAF):** Located on the ventral surface of the neurocranium (Figs. 10, 12-17). In most myliobatidoids, as in most out-groups, the internal carotid artery foramen is paired, but it is single in some species of *Potamotrygon* (Fig. 13A), *Dasyatis*, and *Aetomylaeus* (Fig. 16B) and out-groups (torpedinoids).

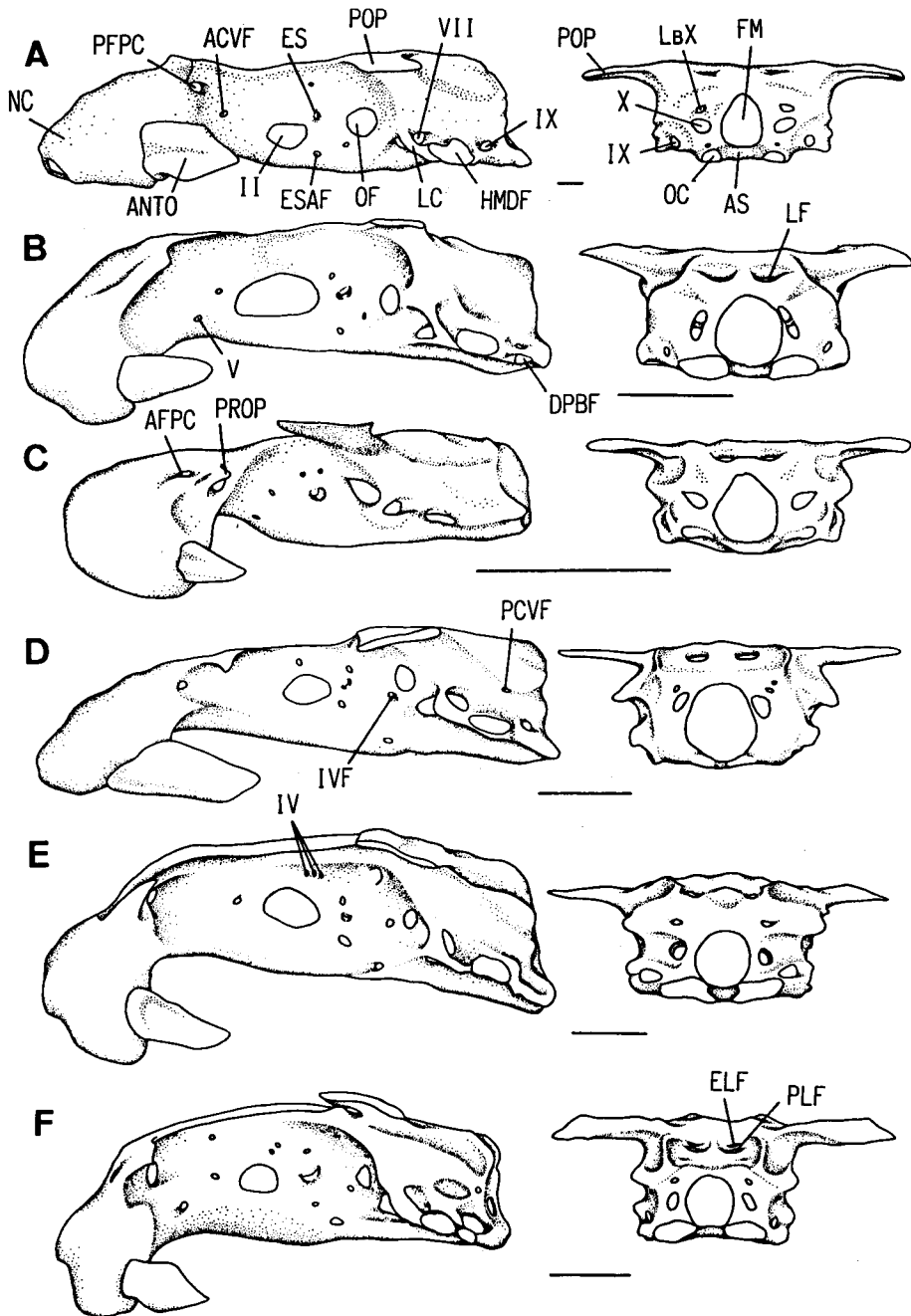

*Discussion.* There are many studies of the neurocranium of skates and rays (e.g., Garman, 1913; Daniel, 1928; Holmgren, 1940, 1941; Hamdy, 1959a, 1959b, 1962b; Stehmann, 1970; Hully, 1972; Compagno, 1977; McEachran and Compagno, 1979; Capape and Desoutter, 1979; Compagno and Roberts, 1982; McEachran, 1984; Compagno and Heemstra, 1984; Fehhelm and McEachran, 1984). However, the myliobatidoid neurocranium, has been poorly studied. During this study, several distinctive features were found and their validity regarding phylogenetic analyses are discussed below.

**Rigidity of neurocranium:** This varies in myliobatidoids. It is relatively soft in *Hexatrygon longirostra* and *Urotrygon daviesi*, but somewhat rigid in *Myliobatis*, *Aetobatus* and *Rhinoptera*. Rigidity in other rajiform groups varies (e.g., soft in torpedinoids, and rigid in pristoids and rhinobatoids). These differences in rigidity may reflect different habitats (soft in deep-water species and rigid in shallow-water species). However, it is difficult to objectively assess degrees of rigidity, and accordingly, this character is not appropriate for phylogenetic analyses.

**Rostral cartilage (RC):** The absence of this cartilage has been regarded as one of the important, synapomorphic characters of the Myliobatidoidei. In a specimen (NSMT-P 40561) of *Urotrygon microphthalmum*, however, a small cartilage is present on the snout tip apart from the neurocranium (Fig. 5). This cartilage is rudimentary and is absent from the second specimen examined (e.g. NSMT-P 40562). In this study, the rudimentary cartilage is recognized as a part of the rostral cartilage and hence, the absence of the rostral cartilage is not included as a synapomorphic character of the Myliobatidoidei, and is not appropriate for phylogenetic analyses. In all myliobatidoids, however, the rostral cartilage absent. On the other hand, in other rajiformes, except in some species of torpedinoids and rajoids, the rostral cartilage is generally long and stout. In the latter, some species have a reduced rostrum.

**Nasal capsule (NC):** In most of the myliobatidoids examined, the nasal capsule was expanded ventrolaterally. However, it was expanded laterally in *Hexatrygon* and *Urotrygon daviesi*. On the other hand, it is expanded laterally in most out-group taxa except in the torpedinoids, in which group where it is expanded ventrolaterally. From the point of view of character analysis, the out group node

---

Fig. 18. Lateral (left) and posterior (right) views of the neurocranium. A, *Urotrygon daviesi*; B, *Urolophus aurantiacus*; C, *Urotrygon microphthalmum*; D, *Potamotrygon yepezi*; E, *Taeniura meyeni*; F, *Dasyatis akajei*. ACVF, anterior cerebral vein foramen; AFPC, anterior foramen for preorbital canal; ANTO, antorbital cartilage; AS, articular surface for synarcual; DPBF, dorsal pseudohyoid bar facet; ELF, endolymphatic foramen; ES, eye stalk; ESAF, efferent spiracular artery foramen; FM, foramen magnum; HMDF, hyomandibular facet; IVF, interorbital vein foramen; LbX, lateralis branch of vagus nerve foramen; LC, lateral commissure; LF, lymphatic foramen; NC, nasal capsule; OC, occipital condyle; OF, orbital fissure; PCVF, posterior cerebral vein foramen; PFPC, posterior foramen for preorbital canal; PLF, perilymphatic foramen; POP, postorbital process; PROP, preorbital process; II, optic nerve foramen; IV, trochlear nerve foramen; V, orbital nasal canal foramen; VII, hyomandibular branch of facial nerve foramen; IX, glossopharyngeal nerve foramen; X, vagus nerve foramen. Scales indicate 10 mm.

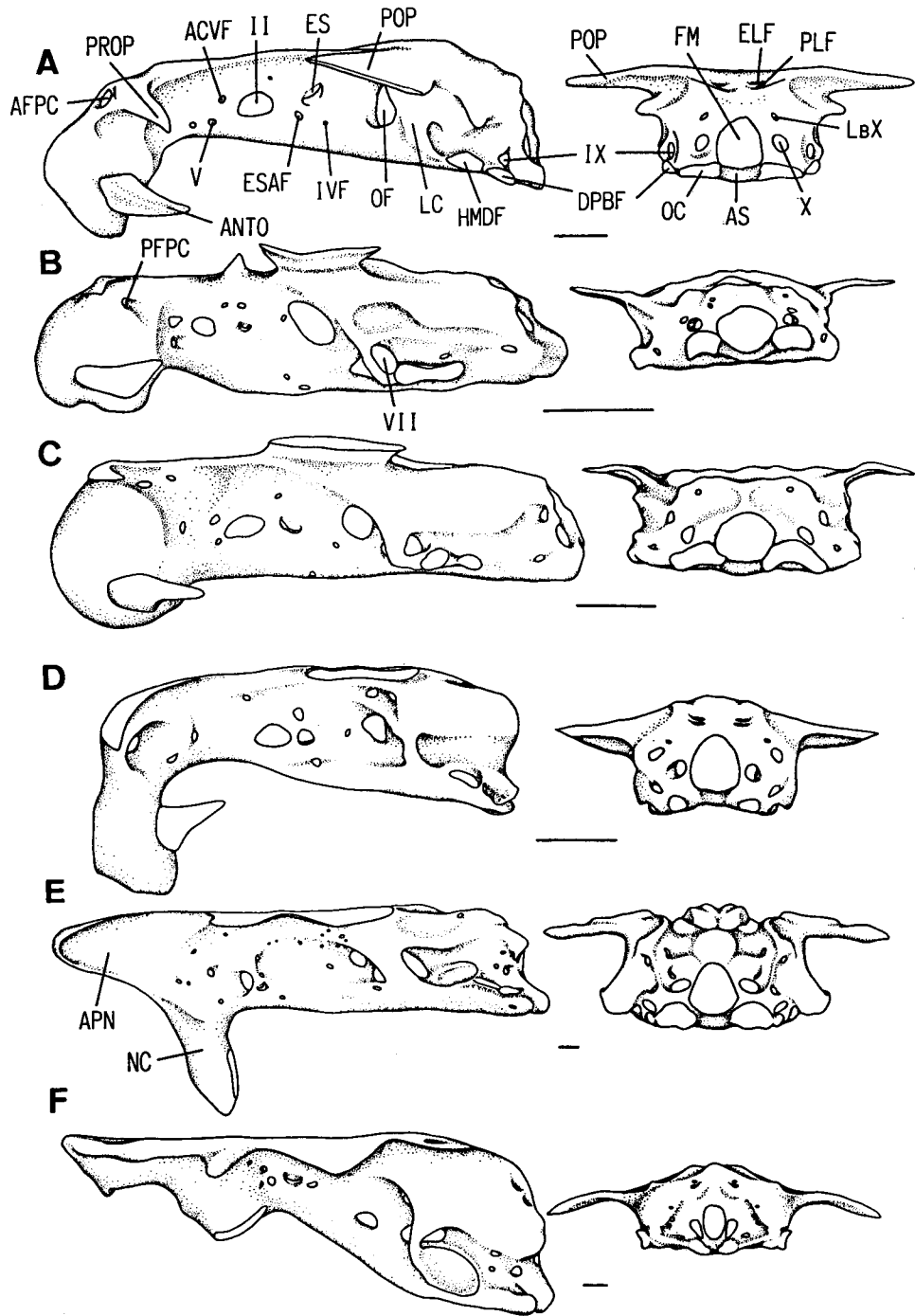

is considered to be a laterally expanded nasal capsule, the derived state being a ventrolateral expansion (character 37).

Internarial width: In *Rhinoptera*, *Mobula* and *Manta*, the internarial width is considerable. On the other hand, the internarial region is narrow in the remaining myliobatidoids. Internarial width, however, changes continuously and, as with neurocranial rigidity, it is difficult to objectively distinguish between states. The character is not appropriate for the present analysis, because of the possibility of subjective treatment. Heemstra and Smith (1980) considered the following condition as a synapomorphic state of the Myliobatidoidei (sensu Heemstra and Smith, 1980, not including *Hexatrygon*): "Nostrils close together, with anterior nasal flaps connected to form a broad nasal curtain overlapping upper jaw". As discussed above, internarial width changes continuously in myliobatidoids, and even in some outgroup taxa, the nostrils are close together (e.g. *Narke*, *Rhinobatos*, *Aptychotrema*). Therefore this character cannot be a myliobatidoid synapomorphy.

Anterior process of neurocranium (APN): This process is absent in most myliobatidoids and in all out-group taxa, but is well developed in *Rhinoptera*, *Mobula* and *Manta*. The derived state therefore, of this character, is presence of an anterior process of the neurocranium (character 99).

Preorbital process (PROP): This is well developed in most myliobatidoids, except in *Rhinoptera*, *Mobula* and *Manta*. In most out-group taxa, the process is correspondingly developed, but it is absent from the Pristoidei and from *Temera* spp. Absence of the preorbital process is considered to be the derived state (character 17).

Supraorbital crest (SOC): All myliobatidoids examined in this study have a supraorbital crest. Although Heemstra and Smith (1980) considered the loss of the supraorbital crest as one of the synapomorphies of the Hexatrygonoidei (Heemstra and Smith, 1980), the example of *Hexatrygon longirostra* examined here, clearly has a supraorbital crest. Absence of the supraorbital crest therefore, cannot be a synapomorphy of *Hexatrygon*, since it simply serves to distinguish *H. bickelli* from *H. longirostra*. The character can not be used in an analysis of myliobatidoid phylogeny because it is consistent within the group. Similarly, a supraorbital crest is present in most out-group taxa (absent in Torpedinoidei).

Interorbital width: Interorbital width is smaller than neurocranium length in most myliobatidoids and in all out-group taxa, but it is greater than neurocranium length in *Mobula* and *Manta*. Accordingly, the latter condition is considered to be the derived state (character 101).

Position of postorbital process: The process is usually located in the otic region, but is more anteriorly located (almost in orbital region) in *Gymnura*, *Aetoplatea*, *Myliobatis*, *Aetomylaeus*, *Aetobatus*, *Rhinoptera*, *Mobula* and *Manta*. In all out-group taxa (except for torpedinoids in which it is absent—character 35), the process is located in the otic region. The derived state of the character is considered to be the more anterior position (character 81).

---

Fig. 19. Lateral (left) and posterior (right) views of the neurocranium. A, *Himantura bleekeri*; B, *Gymnura japonica*; C, *Aetoplatea zonura*; D, *Myliobatis tobijei*; E, *Rhinoptera javanica*; F, *Mobula japonica*. APN, anterior process of neurocranium. For abbreviations, see Fig. 18. Scales indicate 10 mm.

Condition of postorbital processes: The process consists of both anterior and posterior projections in most myliobatidoids. In *Aetobatus*, *Aetomylaeus*, *Rhinoptera*, *Mobula*, *Manta*, *Urotrygon daviesi*, *Urolophus aurantiacus*, *U. expansus* and *U. testaceus*, however, these projections are fused. Most out-group taxa, excepting torpedinoids in which the postorbital process is absent, have separated anterior and posterior projections on the postorbital process. Consequently, fusion of such projections is considered to be a derived state (character 67).

Lateral margin of postorbital process: In *Aetobatus*, *Rhinoptera*, *Mobula* and *Manta*, the lateral margin of the postorbital process is prolonged and ventrally protruded, forming a bar-like projection. This condition, which is absent from both the other myliobatidoids and from all out-group taxa, is considered to be the derived state (character 98).

Numbers of lymphatic foramina: In the Myliobatidoidei examined here, lymphatic foramina number one or two. Both conditions were observed in the same species on several occasions (e.g. *Dasyatis violacea*, *Gymnura japonica*, *Aetoplatea zonura*), and in the light of such intraspecific variation, the character is inappropriate for any phylogenetic analyses.

Anterior foramen for preorbital canal: Located on the anterior surface of the neurocranium in *Myliobatis*, *Aetomylaeus*, *Aetobatus*, *Rhinoptera*, *Mobula* and *Manta*. In other myliobatidoids and in the out-groups examined, the foramen is located on the dorsal surface of the neurocranium. It is therefore considered that the anterior neurocranial position for this foramen, represents a derived condition (character 85).

Numbers of internal carotid artery foramina: Although the carotid foramen is paired in most myliobatidoids, in specimens of *Potamotrygon yepezi*, *Dasyatis zugei* and *Aetomylaeus nichofii*, the carotid foramina are variable in number (one foramen or two very closely located foramina). Because of possible intraspecific variation, therefore, this character is not considered in the phylogenetic analyses. Myliobatidoid out-groups usually have a single internal carotid artery foramen, although one or two may occur in torpedinoids (Holmgren, 1941; pers. obs.).

## 2) Visceral arches

*Description.* Visceral arches of the Myliobatidoidei consist of the mandibular arch, hyoid arch and branchial arches. The hyomandibular cartilage (ontogenetically an element of the hyoid arch) is described along with the mandibular arch, owing to its strong functional relationship with the latter.

**Mandibular arch.** The mandibular arch comprises the mandibular and palatoquadrate cartilages. A laterally compressed, hyomandibular cartilage articulates with the hyomandibular facet on the occipital region of the neurocranium, being directed anterolaterally, and supporting the mandible by its distal inner tip, in all myliobatidoids (Figs. 20, 21) and out-group taxa. In pristoids (Fig. 7A), however, the hyomandibular cartilage is directed posterolaterally, as in sharks. A small, bar-like cartilage, called the hyomandibular accessory cartilage 1 (HAC-1), is loosely attached to the distal tip of the hyomandibular cartilage in *Myliobatis* and *Aetomylaeus* (Fig. 22A). In some species of *Urolophus* and *Dasyatis*, on the other hand, a small, partly calcified, bar-like cartilage supported by connective tissue, and

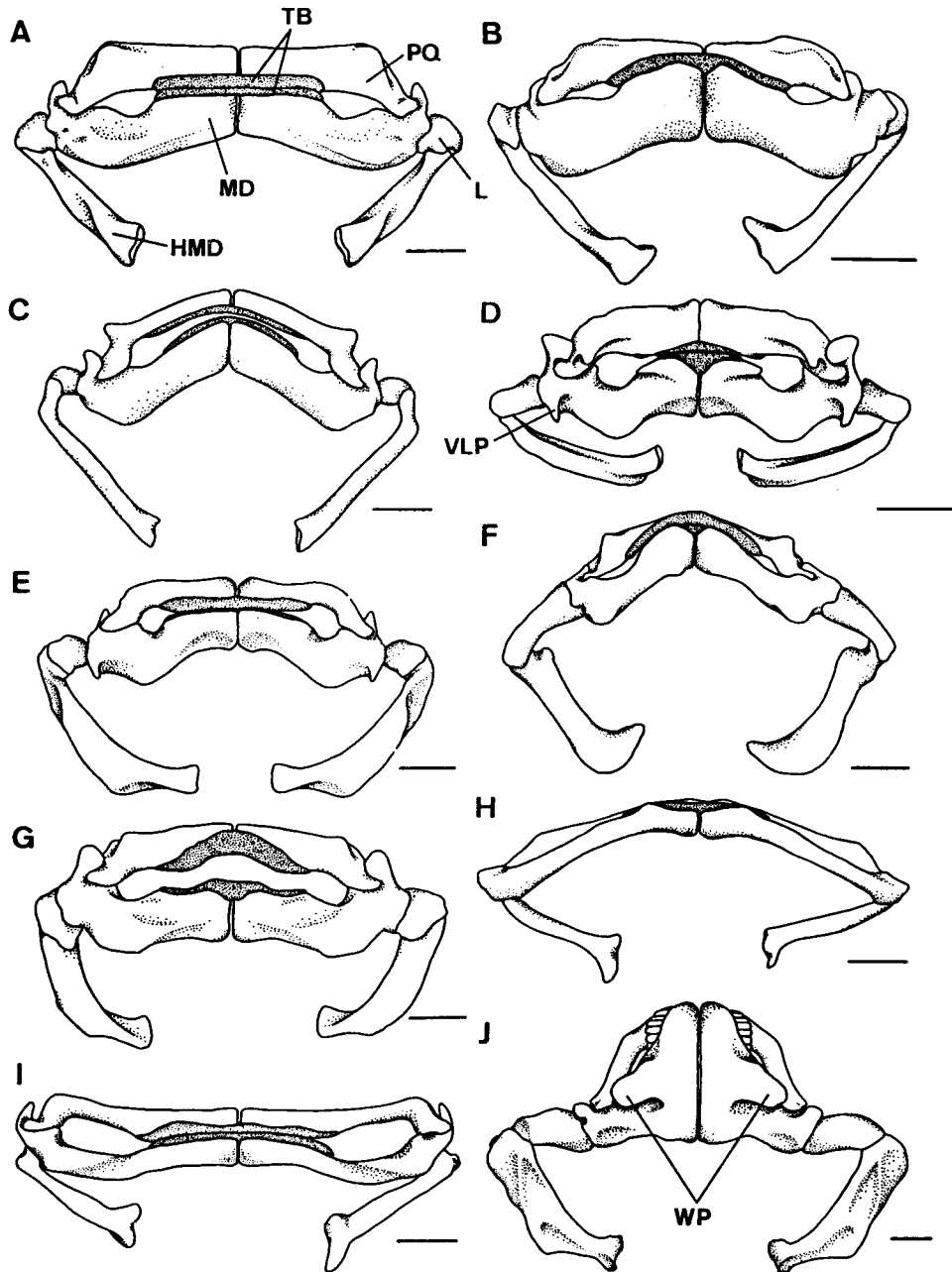

Fig. 20. Ventral view of the mandibular arch. A, *Urotrygon daviesi*; B, *Urolophus testaceus*; C, *Urotrygon asterias*; D, *Potamotrygon yepezi*; E, *Taeniura meyeri*; F, *Dasyatis kuhlii*; G, *Himantura bleekeri*; H, *Gymnura japonica*; I, *Aetoplatea zonura*; J, *Myliobatis goodii*. HMD, hyomandibular cartilage; L, ligament; MD, mandibular cartilage; PQ, palatoquadrate cartilage; TB, tooth band; VLP, ventrolateral process; WP, wing-like process. Scales indicate 10 mm.

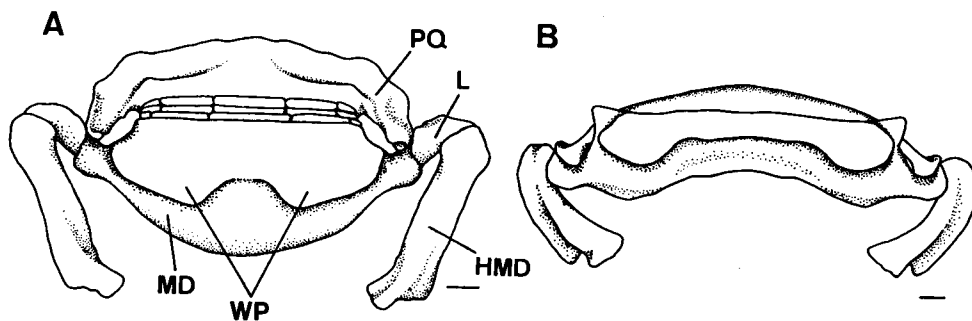

Fig. 21. Ventral view of the mandibular arch. A, *Rhinoptera javanica*; B, *Mobula japonica*. For abbreviations, see Fig. 20. Scales indicate 10 mm.

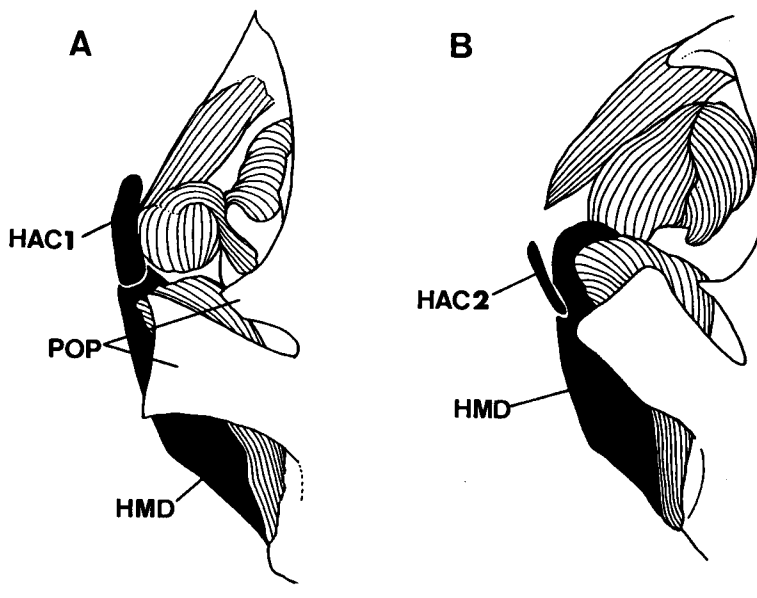

Fig. 22. Dorsal view of the hyomandibular cartilage and its accessory cartilages. A, *Myliobatis californica*; B, *Dasyatis centroura*. HAC1, hyomandibular accessory cartilage 1; HAC2, hyomandibular accessory cartilage 2; HMD, hyomandibular cartilage; POP, postorbital process. Scales indicate 10 mm.

called the hyomandibular accessory cartilage 2 (HAC-2), floats above the hyomandibular cartilage (Fig. 22B). Such hyomandibular accessory cartilages are not observed in any other myliobatidoids. Prespiracular cartilage also occurs near the hyomandibular cartilage, being supported by the levator spiracularis muscle (see Chapter VI-2), and thus forming the anterior wall of the spiracle. Opening and closing of the spiracle is made possible by the association of cartilage and muscle, which are present in all myliobatidoids, although varying in shape (Fig. 23).

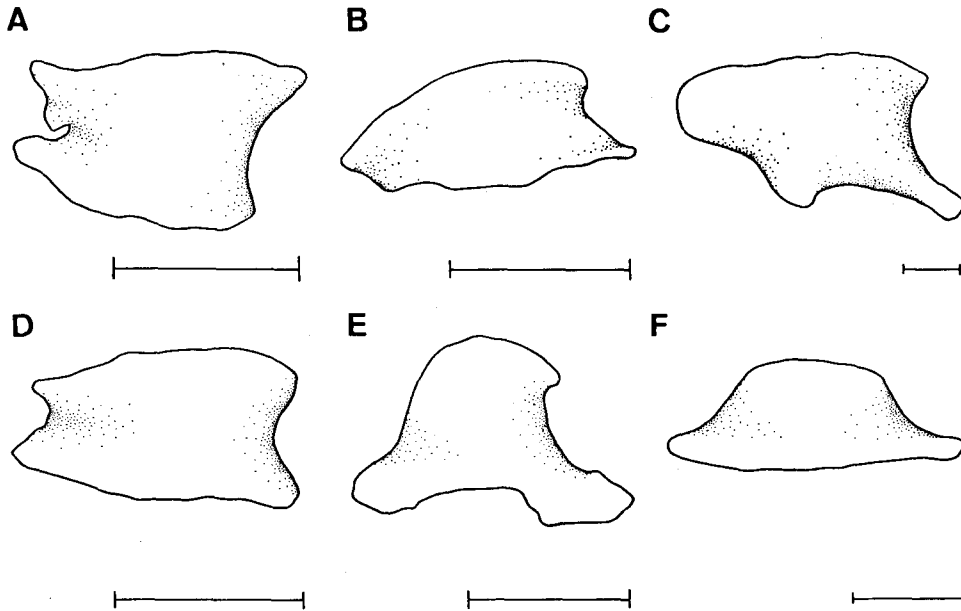

Fig. 23. Anterior view of the prespiracular cartilage. A, *Dasyatis akajei*; B, *Gymnura japonica*; C, *Rhinoptera javanica*; D, *Potamotrygon yepezi*; E, *Rhinobatos hymnicephalus*; F, *Raja pulchra*. Scales indicate 10 mm.

Postspiracular cartilage was not observed in the examined myliobatidoids. Hyomandibular-mandibular articulation varies as follows: direct articulation (*Urotrygon daviesi*, *Hexatrygon*, *Gymnura*, *Aetoplatea*, *Aetomylaeus*, *Mobula* and *Manta* (Fig. 24C), and all out-group taxa (Fig. 24D)); wholly ligamentous connection (*Rhinoptera*, *Urolophus*, *Urotrygon*, *Dasyatis*, *Himantura*, *Taeniura*, *Myliobatis*, *Aetomylaeus* and *Aetobatus* (Fig. 24B)); ligamentous connection involving angular cartilages incorporated within the ligament (*Potamotrygon* (Fig. 24A)). Usually, the mandibular and palatoquadrate cartilages are paired in the Myliobatidoidei (Fig. 20), but in *Aetomylaeus*, *Rhinoptera* (Fig. 21A), *Mobula* (Fig. 21B) and *Manta*, both the right and left halves are strengthened and fused. Although the mandibular cartilage is plate-like in most myliobatidoids, it is relatively narrow and thin in *Gymnura* (Fig. 20H) and *Aetoplatea* (Fig. 20I), and expanded and thickened in *Myliobatis* (Fig. 20J), *Aetobatus*, *Aetomylaeus* and *Rhinoptera* (Fig. 21A). A pair of posteriorly expanded, wing-like processes (WP) are present on the ventral surface of the mandibular cartilage in *Myliobatis* (Fig. 20J), *Aetobatus*, *Aetomylaeus*, *Rhinoptera* (Fig. 21A), *Mobula* (Fig. 21B) and *Manta*. At the distal corner of the mandibular cartilage, a small ventrally-directed process (ventrolateral process of mandibular (VLP)), is present in several myliobatidoids (Fig. 20D, E), but such a process is not developed in *Myliobatis* (Fig. 20J), *Aetobatus*, *Aetomylaeus*, *Rhinoptera* (Fig. 21A), *Mobula* (Fig. 21B), or *Manta*, nor in some species of *Gymnura* and *Aetoplatea* (Fig. 20I). The palatoquadrate cartilage articulates with the man-

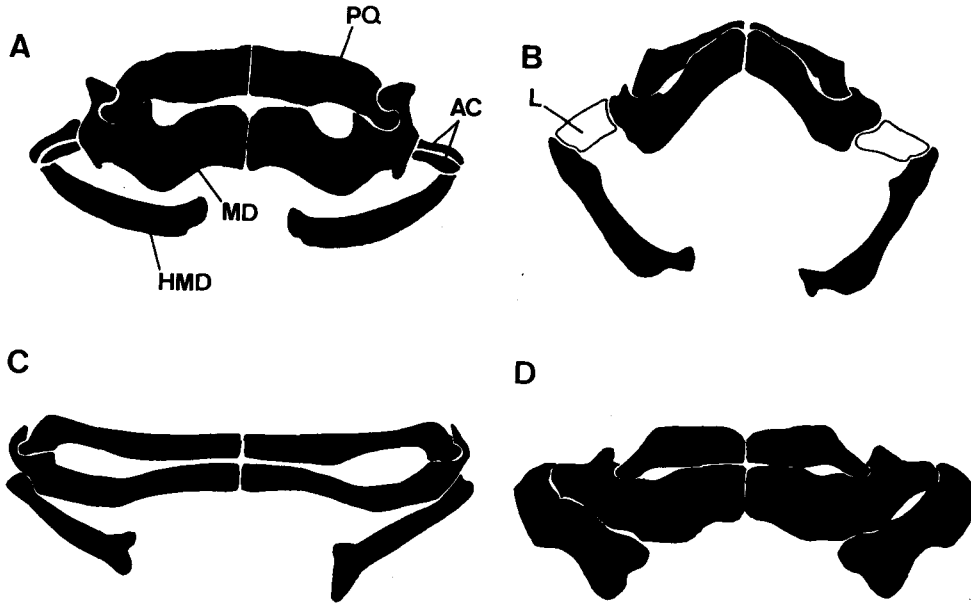

Fig. 24. Ventral view of the hyomandibular-mandibular articulation. A, *Potamotrygon yepezi*; B, *Dasyatis pastinaca*; C, *Aetoplatea zonura*; D, *Narke japonica*. AC, angular cartilage; HMD, hyomandibular cartilage; L, ligament; MD, mandibular cartilage; PQ, palatoquadrate cartilage.

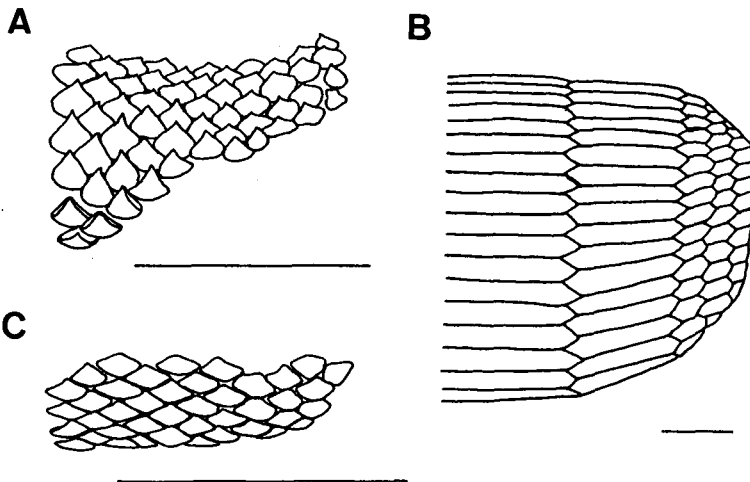

Fig. 25. Ventral view of lower jaw teeth (left side). A, *Potamotrygon yepezi*; B, *Rhinoptera javanica*; C, *Narke japonica*. Scales indicate 10 mm.

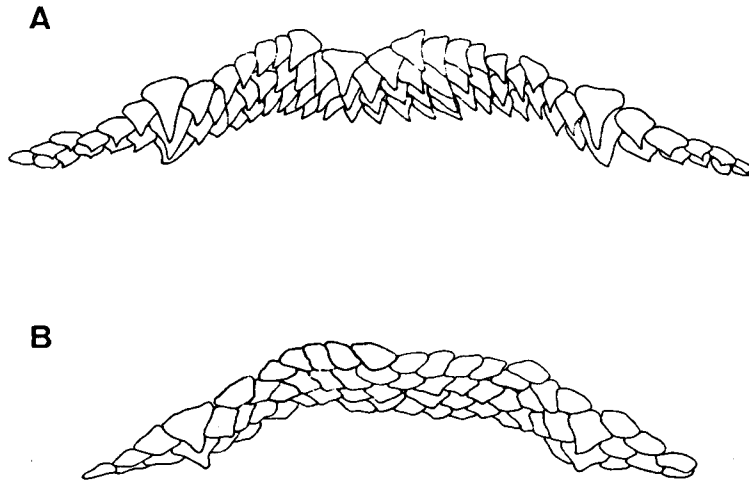
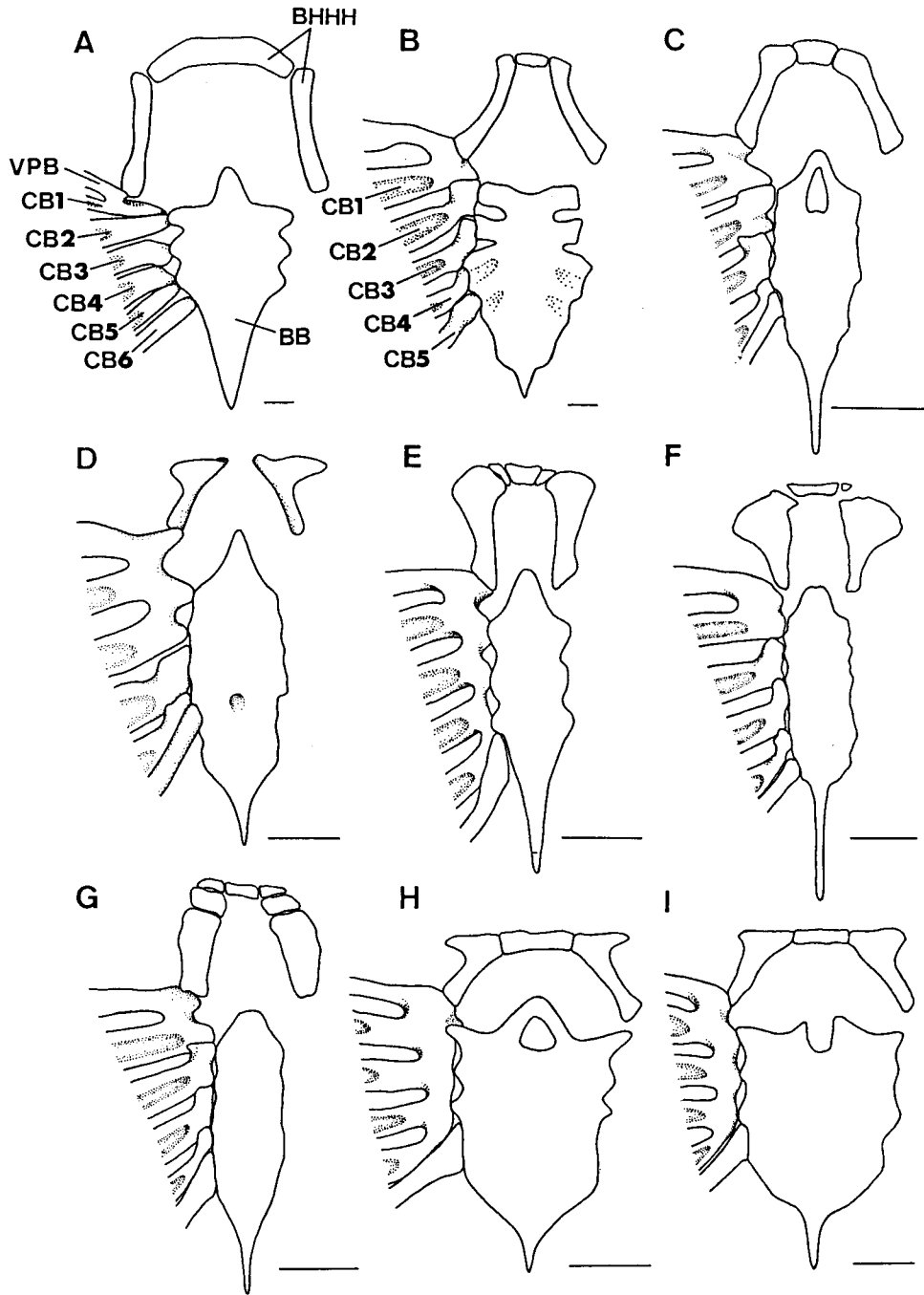

Fig. 26. Ventral view of upper jaw teeth in *Dasyatis kuhlii*. A, male; B, female.

dibular cartilage on its distal corner, and has no relationship with the hyomandibular cartilage within the Myliobatidoidei.

Usually, opposing tooth bands are located on the mandibular and palatoquadrate cartilages. *Manta birostris*, however, lacks upper jaw teeth. Both the number and shape of the teeth vary in the Myliobatidoidei (see Fig. 25 and Tab. 1), and sexual dental dimorphism occurs in most species. Generally flat, non-cuspid teeth are seen in females, with sharp, cuspid teeth in males. However, sexual dimorphism is not observed in *Myliobatis*, *Aetobatus*, *Aetomylaeus* or *Rhinoptera*, which have flat, pavement-like teeth (Fig. 25B). Some *Dasyatis* species (e.g., *D. kuhlii* and *D. pastinaca*; see Fig. 26), have large teeth near the center of the palatoquadrate cartilage. Such a condition is not known in other myliobatidoids.

**Hyoid arch.** The hyoid arch comprises hyomandibular cartilage (discussed above), dorsal pseudohyoid bar, and hypo- and basi-hyoid cartilages. The dorsal and ventral pseudohyoid bars are generally similar to the epi- and cerato-branchial cartilages, with the proximal tip of ventral pseudohyoid bar being fused with that of the 1st ceratobranchial cartilage in myliobatidoids (Figs. 27, 28A-C). This condition was not observed in any out-groups (Fig. 28D-G). The ventral pseudohyoid cartilage is directed anterolaterally, supporting the gill rays ventrally, and distally articulating with the dorsal pseudohyoid bar. In myliobatidoids, the dorsal pseudohyoid bar is attached to both the neurocranium and hyomandibular cartilage by its distal tip, and is directed anterolaterally, supporting the dorsal gill rays. The number of gill rays supported by the dorsal and ventral pseudohyoid bars vary considerably (Tab. 1). The hypo- and basi-hyoid cartilages consist of a few, dorso-ventrally flattened, plate-like elements in most myliobatidoids (Fig. 27), the former usually articulating with the ventral pseudohyoid bars posteriorly, and anteriorly supporting the basihyoid cartilage. The basihyoid cartilage is segmented



in some species of *Urolophus*, *Potamotrygon* (Fig. 27E), *Taeniura* (Fig. 27F), *Dasyatis* (Fig. 27G) and *Himantura*, and is completely absent from *Urotrygon mundus* (Fig. 27D). In *Aetomylaeus*, *Aetobatus*, *Rhinoptera* (Fig. 28B), *Mobula* (Fig. 28C) and *Manta* on the other hand, both hypo- and basi-hyoid cartilages are absent. In *Myliobatis*, these cartilages are reduced to a pair of small, bar-like cartilages, supported by connective tissue (Fig. 28A).

**Branchial arches.** The branchial arches generally comprise basibranchial, hypobranchial, ceratobranchial, epibranchial and pharyngobranchial cartilages. Although most myliobatidoids have five paired branchial arches (Figs. 27B-I, 28A-C), *Hexatrygon longirostra* has six (Fig. 27A). In all of the myliobatidoids examined the basibranchial and hypobranchial cartilages were fused, forming a single plate. The basibranchial cartilage has a bat-like shape, with an anteriorly positioned hole in some species of *Urolophus* (Fig. 27C), *Dasyatis* and *Gymnura* (Fig. 27H). All of the ceratobranchials are articulated proximally with the lateral corner of the basibranchial cartilage. In *Urotrygon* (Fig. 27D) (except *U. daviesi*), *Potamotrygon* (Fig. 27E), *Dasyatis zugei*, *Gymnura* (Fig. 27H) and *Aetoplatea* (Fig. 27I), the 1st and 2nd ceratobranchial cartilages are fused proximally. Furthermore in *Potamotrygon* (Fig. 27E), *Gymnura* (Fig. 27H) and *Aetoplatea* (Fig. 27I), such fusion includes also the 3rd and 4th ceratobranchials. In all other myliobatidoids and out-group taxa, proximal fusion of the ceratobranchial cartilages does not occur. The first to 3rd (4th in *Hexatrygon*) ceratobranchial cartilages are laterally directed, distally articulating with the 1st to 3rd (4th) epibranchial cartilages, and ventrally supporting the gill rays. The last ceratobranchial cartilage articulates with the inner side of the scapulocoracoid cartilage (see Chapter VI-1-3), does not support gill rays, and the first to 3rd (4th) epibranchial cartilages articulate distally with the 1st to 3rd (4th) ceratobranchial cartilages. The epibranchials articulate with the pharyngobranchial cartilages proximally (Fig. 29) and dorsally support the gill rays. The last epibranchial cartilage articulates distally with the inner side of the pectoral girdle just above the articulation of the last ceratobranchial cartilage (see Chapter VI-1-3). In *Urotrygon daviesi*, the last epibranchial cartilage articulates with the fused 4th and 5th pharyngobranchial cartilages (Fig. 29A). In all other myliobatidoids, the last epibranchial is fused with the 4th and 5th pharyngobranchial cartilages (Fig. 29B,C). The pharyngobranchial cartilages themselves, are loosely articulated with the ventrolateral corner of the 1st synarcual. In most myliobatidoids, only the 4th and 5th pharyngobranchial cartilages are fused to each other, but in *Hexatrygon longirostra*, all of the pharyngobranchials are fused (Fig. 29B).

**Discussion.** There are many studies on the visceral arches: general anatomical (Garman, 1913; Daniel, 1928; Hamdy, 1959a; Hamdy and Khalil, 1963a;

---

Fig. 27. Dorsal view of the ventral parts of the hyoid and branchial arches (neurocranium and synarcual removed). A, *Hexatrygon longirostra*; B, *Urotrygon daviesi*; C, *Urolophus testaceus*; D, *Urotrygon asterias*; E, *Potamotrygon yepezi*; F, *Taeniura meyeni*; G, *Dasyatis pastinaca*; H, *Gymnura japonica*; I, *Aetoplatea zomura*. BB, basibranchial cartilage; BHHH, hypo- and basi-hyoid cartilages; VPB, ventral pseudohyoid bar; 1-6 CB, 1-6 ceratobranchial cartilages. Scales indicate 10 mm.

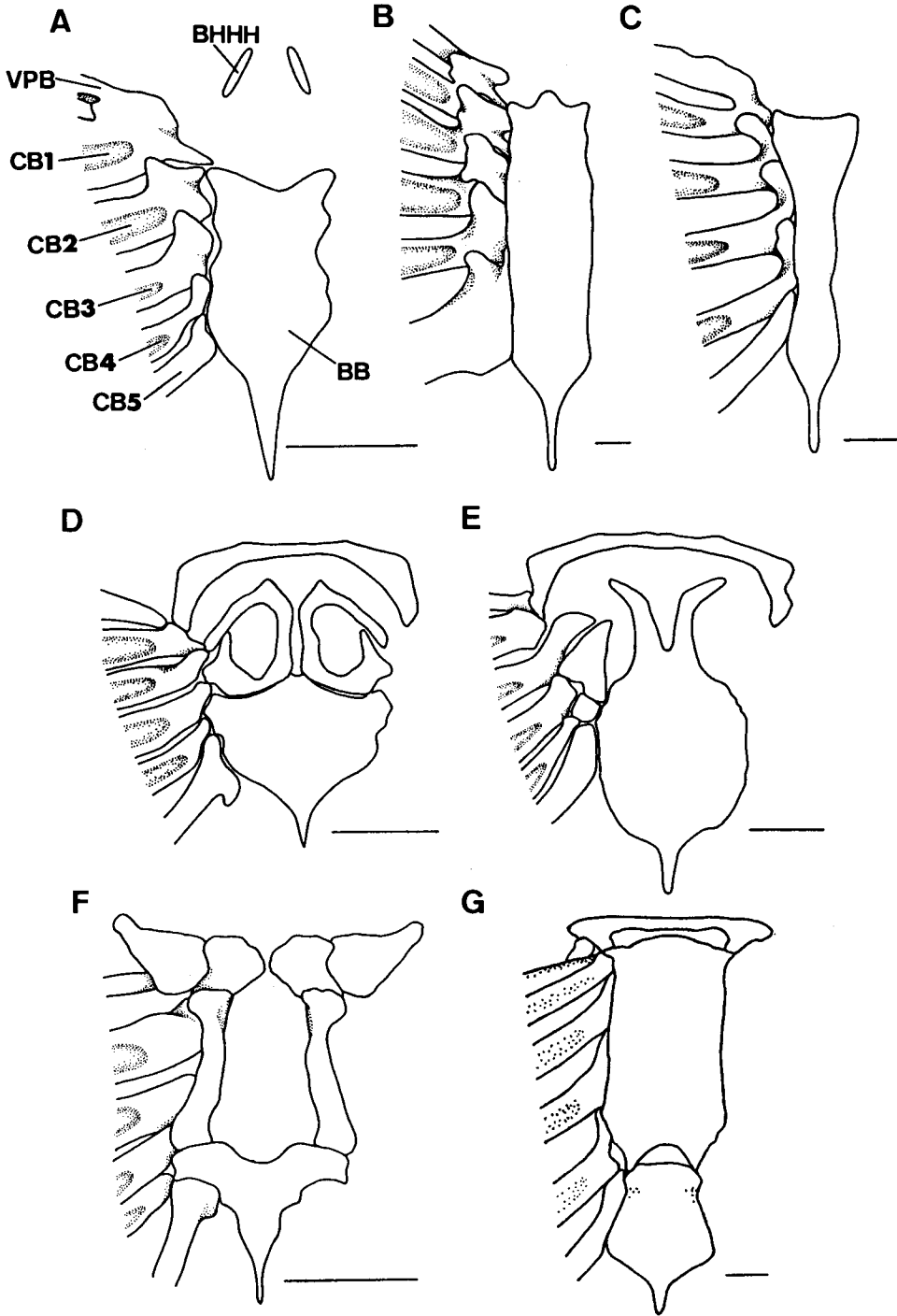

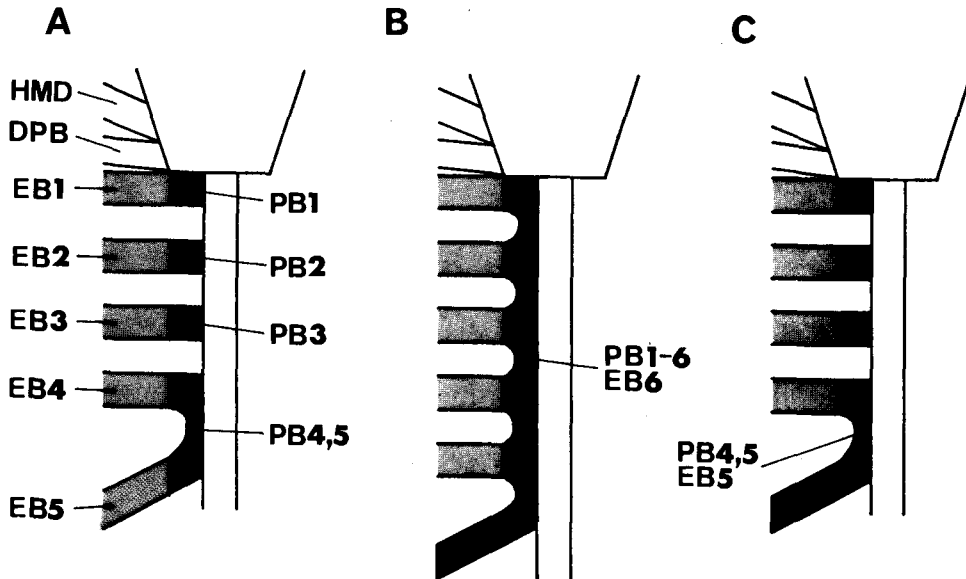

Fig. 29. Diagrammatic representation of the three hyoid and branchial arches dorsal patterns. A, *Urotrygon daviesi*; B, *Hexatrygon longirostra*; C, typical rajiform pattern. DPB, dorsal pseudohyoid bar; HMD, hyomandibular cartilage; 1-6 EB, 1-6 epibranchial cartilage; 1-6 PB, 1-6 pharyngobranchial cartilages.

Compagno, 1977; Heemstra and Smith, 1980; Fechhelm and McEachran, 1984; Rosa et al., 1987); ontogenetic (Holmgren, 1940; Hamdy, 1962a); anatomical mandibular arch and accessory cartilages (Feduccia and Slaughter, 1974; Maisey, 1980; Compagno and Heemstra, 1984); and anatomical hyoid arch (De Beer, 1932; Hamdy and Khalil, 1963b). There are, however, no phylogenetic studies of myliobatidoids using such anatomical data. Re-examination of the visceral arches of the myliobatidoids and out-group taxa, showed many phylogenetically significant differences. These characters are discussed below:

**Hyomandibular Accessory Cartilage 1 (HAC-1):** In *Myliobatis* and *Aetomylaeus*, a Hyomandibular Accessory Cartilage 1 (HAC-1) is loosely attached to the distal tip of the hyomandibular cartilage. This cartilage is not observed in other myliobatidoids nor in all out-group taxa. Presence of HAC-1 is considered to be the derived character state (character 94).

**Hyomandibular Accessory Cartilage 2 (HAC-2):** In some species of *Urolophus* and *Dasyatis*, Hyomandibular Accessory cartilage 2 (HAC-2) floats in connective tissue just above the hyomandibular cartilage. This small cartilage is not found in other myliobatidoids, nor in all out-group taxa. Presence of HAC-2 is considered to

Fig. 28. Dorsal view of the ventral parts of the hyoid and branchial arches (neurocranium and synarcual removed). A, *Myliobatis tobijei*; B, *Rhinoptera javanica*; C, *Mobula japonica*; D, *Rhinobatos hynnicephalus*; E, *Raja pulchra*; F, *Narke japonica*; G, *Pristis microdon*. For abbreviations, see Fig. 27. Scales indicate 10 mm.

Table 1. Number of jaw teeth and pseudohyoid gill rays.

Species	Upper jaw teeth	Lower jaw teeth	Dorsal pseudohyoid gill rays	Central pseudohyoid gill rays	Ventral pseudohyoid gill rays
<i>Urotrygon daviesi</i>	39	43			
<i>Urolophus concentricus</i>			10	1	8
<i>U. halleri</i>	37	33	11	1	9
<i>U. maculatus</i>	31	27	10	1	8
<i>U. aurantiacus</i>	33~39	33~43	11	1	9
<i>U. testaceus</i>	34~37	24~29	8	1	7
<i>Urotrygon asterias</i>	39	41	11	0	9
<i>U. mundus</i>	37	37	7	1	6
<i>Potamotrygon castexi</i>	39	43	10	1	8
<i>P. hystrix</i>	27	31	11	1	9
<i>P. motroro</i>	25	33	11	1	9
<i>P. yepezi</i>	23	23			
<i>P. magdalenae</i>	24	22	10	1	8
<i>Taeniura lymna</i>	23	23			
<i>T. meyeri</i>	44	32			
<i>Dasyatis acutirostra</i>	40~51	39~49	12	1	10
<i>D. akajei</i>	33	37	12	1	10
<i>D. bennetti</i>	31	33	13	1	9
<i>D. brevis</i>	37	41	14	1	9
<i>D. centronura</i>	39	43	15	1	11
<i>D. guttata</i>			13	0	11
<i>D. kuhlii</i>	25~30	27~31	11	1	8
<i>D. margaritella</i>	39	39	10	1	10
<i>D. matsubarai</i>	29	35	15	1	10
<i>D. pastinaca</i>	30~35	29~33	10	1	8
<i>D. sabina</i>	30	34	13	1	8
<i>D. say</i>	39	45	13	1	9
<i>D. violacea</i>	25	27	12	0	9
<i>D. zugei</i>	40~55	39~55	9	1	8
<i>Himantura bleekeri</i>	23	23	13	1	9
<i>H. gerrardi</i>	33	37	12	1	10
<i>Gymnura altavela</i>	101	93	20	1	13
<i>G. japonica</i>	67~75	59~63	15	1	12
<i>G. poecilura</i>	71		18	1	12
<i>Aetoplatea zonura</i>	65~69	61~65	17	1	13
<i>Myliobatis aquila</i>	7	7	12	1	8
<i>M. californica</i>	7	7	14	1	9
<i>M. goodei</i>	7	7	12	1	8
<i>M. tobijei</i>	7	7	10	1	10
<i>Aetomylaeus nichofii</i>	7	7	12	1	9
<i>Aetobatus narinari</i>	1	1			
<i>Rhinoptera bonasus</i>	9	9			
<i>R. javanica</i>	9	9			
<i>M. japonica</i>	130	130			

be the derived character state (character 73).

Shape of prepiracular cartilage: The prepiracular cartilage varies in shape (Fig. 23), the character, showing intraspecific variation in some species (e.g., *Dasyatis akajei* *D. kuhlii*). Therefore, it is unsuitable for any phylogenetic analysis.

Ligament between mandibular and hyomandibular cartilages: In *Urolophus*, *Urotrygon*, *Potamotrygon*, *Taeniura*, *Dasyatis*, *Himantura*, *Myliobatis*, *Aetomylaeus*, *Aetobatus* and *Rhinoptera*, the hyomandibular cartilage does not directly support the mandibular cartilage, having ligament more or less present between them. In other myliobatidoids and in all out-group taxa, such a ligament is absent, and the cartilages articulate directly. Presence of the intermediary ligament is considered to be the derived character state (character 71).

Angular Cartilage (AC) between mandibular and hyomandibular cartilages: In *Potamotrygon*, a small angular cartilage is present in the ligament between the mandibular and hyomandibular cartilages. A similar condition was reported in *Potamotrygon circularis* and *Plesiotrygon iwamae* (Garman, 1913; Rosa et al., 1987), but has not been observed in other myliobatidoids, nor in any out-group taxa. Presence of the angular cartilage is considered to be the derived character state (character 75).

Symphysis fusion of both mandibular and palatoquadrate cartilages: In *Aetomylaeus*, *Rhinoptera*, *Mobula* and *Manta*, the mandibular and palatoquadrate cartilages are fused at the symphysis. This condition was not observed in other myliobatidoids, nor in out-group taxa. Symphysis fusion of both the mandibular and palatoquadrate cartilages is considered to be the derived character state (character 97).

Mandibular cartilage (MD): In *Myliobatis*, *Aetomylaeus*, *Aetobatus* and *Rhinoptera*, the mandibular cartilages are expanded and thickened near the symphysis. In other myliobatidoids and in all out-group taxa, the mandibular cartilages are elongate and thinner near the symphysis. An expanded and thickened mandibular cartilage is considered to be the derived character state (character 92).

Wing-like process on mandibular cartilage (WP): In *Myliobatis*, *Aetomylaeus*, *Aetobatus*, *Rhinoptera*, *Mobula* and *Manta* a wing-like process is present on the ventral surface of the mandibular cartilage. Such a process is absent from all other myliobatidoids and from all out-group taxa. Presence of the process is considered to be the derived character state (character 86).

Ventrolateral process (VLP) on mandibular cartilage: In most species of *Potamotrygon*, *Taeniura* and *Dasyatis*, a ventrally directed ventrolateral process (VLP) is present on the distal corner of the mandibular cartilage. In other myliobatidoids and in all out-group taxa, this process is reduced nor almost absent. The degree of development of this process is, however, variable, and it is difficult to separate differences into distinct character states. Accordingly, this character is not suitable for phylogenetic analyses.

Upper jaw teeth: Upper jaw teeth are absent in *Manta* (Coles, 1916; Bigelow and Schroeder, 1953; pers. obs.). This may be related to its plankton feeding habit. The condition is not seen in other myliobatidoids or in all out-group taxa. Absence of upper jaw teeth is considered to be the derived character state (character 104).

Number, size and shape of teeth: As shown in Table 1, myliobatidoid teeth vary in number. Upper and lower jaw teeth number between 20-65 in each in *Urotrygon*, *Urolophus*, *Potamotrygon*, *Taeniura*, *Dasyatis* and *Himantura*, 65-100 and 60-100 respectively in *Gymnura* and *Aetoplatea*, 1-10 in each in *Myliobatis*, *Aetomylaeus*, *Aetobatus* and *Rhinoptera*, and 35-140 and 35-155 respectively in *Mobula*. Not only does the number of teeth generally increase during growth (Notarbartolo-di-Sciara, 1987 and pers. obs.), but also the size is variable. Usually centrally positioned teeth are larger than those at the sides, and in some species of *Dasyatis*, large teeth are present near the center of the palatoquadrate cartilage (remarkably so in *Dasyatis kuhlii* (Fig. 26) and *D. pastinaca*). Teeth shape usually shows sexual dimorphism (Rosa et al., 1987 and pers. obs.). Accordingly, number, size and shape of teeth cannot be used for phylogenetic analyses.

Flat, pavement-like teeth: In *Myliobatis*, *Aetomylaeus*, *Aetobatus* and *Rhinoptera*, the teeth of both jaws are flat and pavement-like. This condition is not seen in other myliobatidoids or in out-group taxa. Flat and pavement-like teeth are considered to be the derived character state (character 93).

Ventral pseudohyoid bar and 1st ceratobranchial cartilage: In all myliobatidoids, the ventral pseudohyoid bar is fused proximally with the 1st ceratobranchial cartilage. This condition is not observed in any out-group taxa, and is considered to be a myliobatidoid autapomorphy (character 61).

Number of gill rays: As shown in Table 1, the number of gill rays supported by the dorsal and ventral pseudohyoid bars varies. The least number recorded was 7-1-6 (in *Urotrygon mundus*) and the greatest number, 20-1-13 (in *Gymnura altavela*). Because variation in gill ray number is continuous, the character is not suitable for phylogenetic analysis.

Hypo- and basi-hyoid cartilages: These cartilages are absent in *Aetomylaeus*, *Aetobatus*, *Rhinoptera*, *Mobula* and *Manta*, but in other myliobatidoids and in all out-group taxa, they are more or less present. Absence of the hypo- and basi-hyoid cartilages are considered to be the derived character state (character 95).

Number of branchial arches: In most myliobatidoids and all out-group taxa, the number of branchial arches is five, but is six in *Hexatrygon*. Six branchial arches is considered to be the derived character state (character 68).

Hole in the basibranchial cartilage: In *Urolophus aurantiacus*, *U. testaceus*, *Dasyatis kuhlii* and *Gymnura japonica*, a hole is present on the anterior part of the basibranchial cartilage. It is absent in other myliobatidoids and in all out-group taxa. Because both conditions were observed in *Gymnura japonica*, it is considered to be an unstable character, which is not suitable for phylogenetic analysis.

Fusion of 1st and 2nd ceratobranchial cartilages: In *Urotrygon* (except *U. daviesi*), *Potamotrygon*, *Dasyatis zugei*, *Gymnura* and *Aetoplatea*, the 1st and 2nd ceratobranchial cartilages are proximally fused. In other myliobatidoids and in all out-group taxa, such fusion was not observed. Fusion of the derived character state (character 74).

First 4 ceratobranchial cartilages fused: In *Potamotrygon*, *Gymnura* and *Aetoplatea*, first 4 ceratobranchial cartilages are proximally fused. In other myliobatidoids and in all out-group taxa, this condition was not observed. Fusion of the first 4 ceratobranchial cartilages is considered to be the derived character state

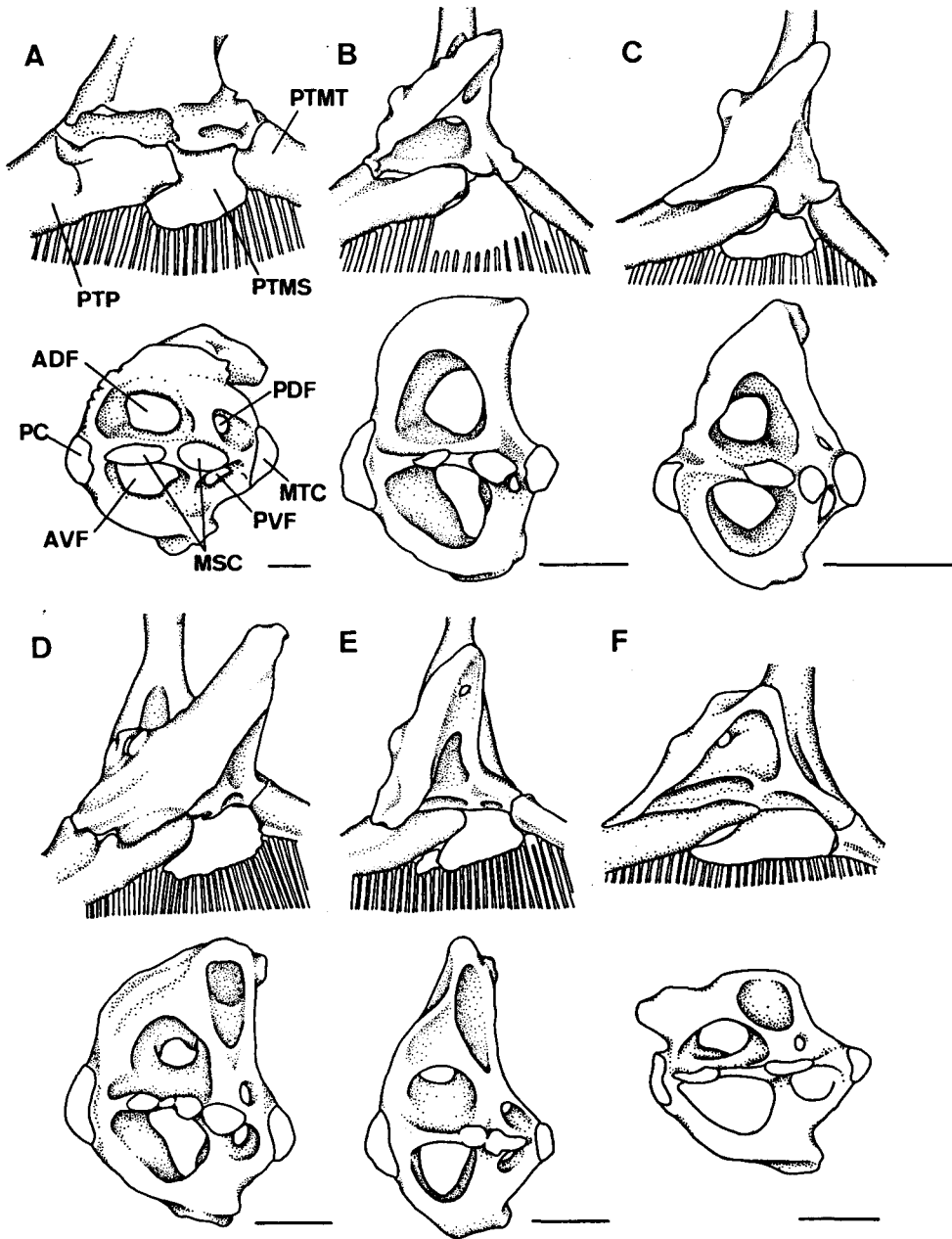
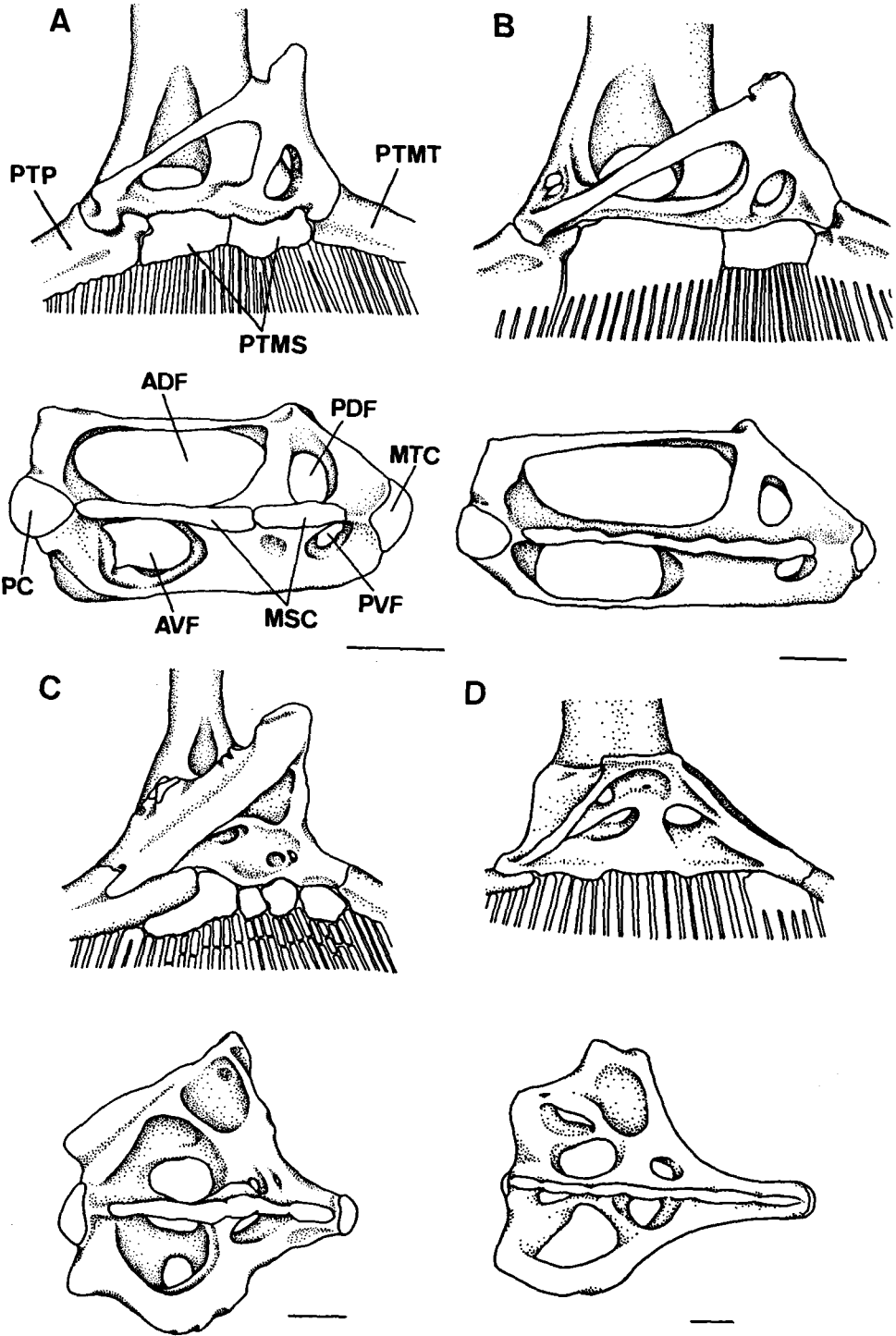

Fig. 30. Dorsal (upper) and lateral (lower) views of the scapulocoracoid. A, *Urotrygon daviesi*; B, *Urolophus testaceus*; C, *Potamotrygon yepezi*; D, *Taeniura meyeni*; E, *Dasyatis matsubarae*; F, *Himantura bleekeri*. ADF, anterodorsal fenestra; AVF, anteroventral fenestra; MSC, mesocondyle; MTC, metacondyle; PC, procondyle; PDF, postdorsal fenestra; PTP, pectoral propterygium; PTMS, pectoral mesopterygium; PTMT, pectoral metapterygium; PVF, postventral fenestra. Scales indicate 10 mm.



(character 76).

Last epibranchial cartilage not fused with pharyngobranchial cartilages: In *Urotrygon daviesi*, and the out-group genera *Benthobatis*, *Discopyge*, *Diplobatis* and *Narcine*, the last epibranchial cartilage is not fused with the 4th and 5th pharyngobranchial cartilages. In other myliobatidoids and most of the out-group taxa, fusion of these cartilages occurs. Lack of fusion of the last epibranchial cartilage is considered to be the derived character state (character 46).

All pharyngobranchial cartilages fused: In *Hexatrygon longirostra*, all pharyngobranchial cartilages are fused, whereas all other myliobatidoids and all out-group taxa have only the 4th and 5th pharyngobranchial cartilages fused. Fusion of all of the pharyngobranchial cartilages is considered to be the derived character state (character 69).

### 3) Scapulocoracoid (pectoral girdle), pectoral fin and cephalic fin

*Description.* The scapulocoracoid (pectoral girdle) comprises the coracoid cartilage, scapular process and suprascapular. The coracoid cartilage is dorsoventrally flattened, and is located under the synarcual, where it supports the pectoral fin with the scapular process elevated dorsally (Figs. 30-32). In most myliobatidoids, the scapulocoracoid is sub-rectangular in lateral view. It is, however, anteroposteriorly elongated in *Gymnura* (Fig. 31A) and *Aetoplatea* (Fig. 31B). In *Mobula* (Fig. 32B) and *Manta*, the scapulocoracoid is anteriorly elongate, and fuses with the pectoral propterygium. In most myliobatidoids examined here, the snout was supported by the pectoral propterygia and radials (Figs. 5, 35B). In *Hexatrygon*, however, the snout was supported by rostral extensions of the propterygia alone (Fig. 35A).

Several foramina for muscles and nerves, and condyles for the pectoral pterygia are located on the lateral surface of the scapulocoracoid. The procondyle (for the propterygium), mesocondyle (mesopterygium) and metacondyle (metapterygium) are located along the horizontal axis of the scapulocoracoid. The number of the mesocondyles ranges from 0-4 in myliobatidoids (Figs. 30-32). The specimens examined here had anterodorsal fenestrae above the scapulocoracoid condyles, and anteroventral fenestrae below. The condition and number of anterodorsal fenestrae varies: a single fenestra in *Potamotrygon* (Fig. 30C), *Gymnura* (Fig. 31A), *Aetoplatea* (Fig. 31B), and some species of *Urolophus* (Fig. 30B) and *Urotrygon* (Fig. 30A); a single fenestra with a depression above it in some species of *Urolophus*, *Urotrygon*, *Dasyatis*, *Himantura*, *Taeniura* (Fig. 30D), *Myliobatis* (Fig. 31C), *Mobula* (Fig. 32B) and *Manta*; two fenestrae, meeting as they pass to the inner side of the scapulocoracoid in some species of *Urolophus*, *Urotrygon*, *Dasyatis* (Fig. 30E), *Himantura* (Fig. 30F) and *Taeniura*; and two completely separated fenestrae in *Rhinoptera* (Fig. 32A) and some species of *Dasyatis*, *Himantura* and *Taeniura*. A posterodorsal fenestra is present in most myliobatidoids, but is lacking in *Urolophus* (Fig. 30B) and *Urotrygon* (except *Urotrygon daviesi*). Two condyles for articulation

Fig. 31. Dorsal (upper) and lateral (lower) views of the scapulocoracoid. A, *Gymnura japonica*; B, *Aetoplatea zonura*; C, *Myliobatis goodei*; D, *Aetomylaeus nichofii*. For abbreviations, see Fig. 30. Scales indicate 10 mm.

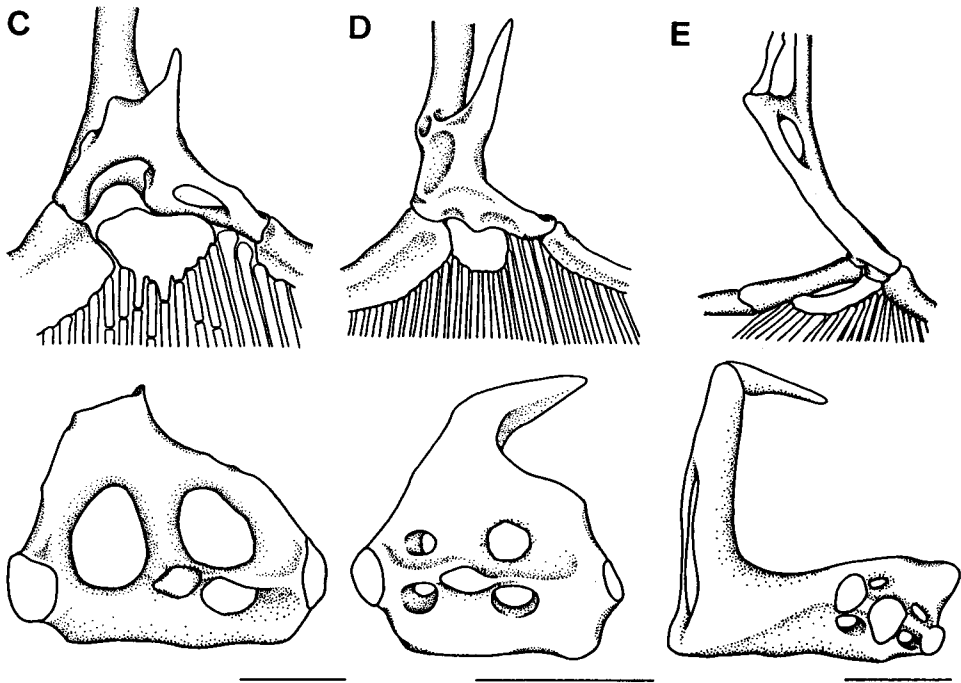
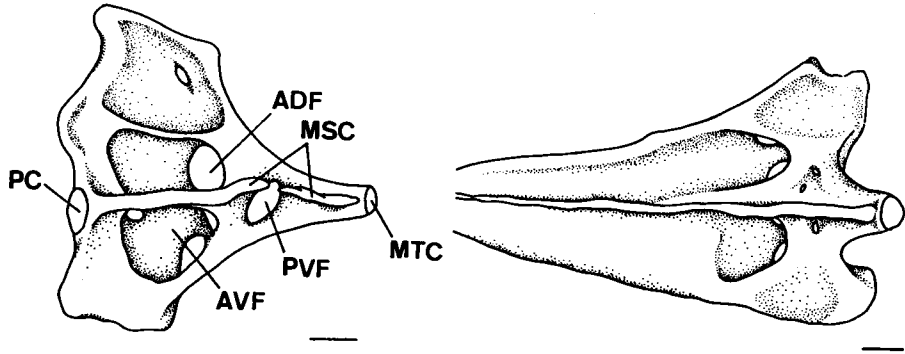
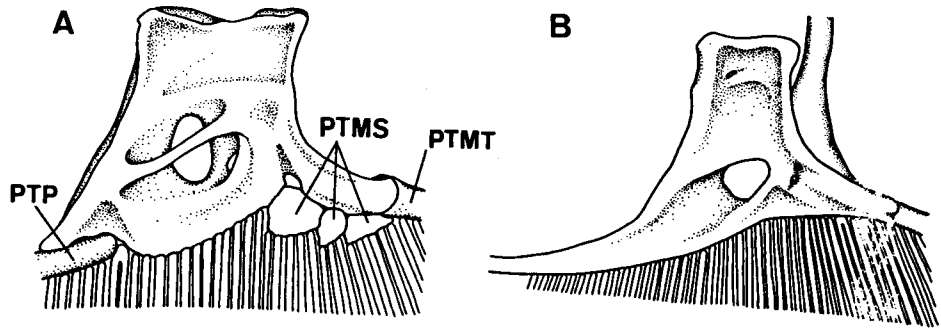

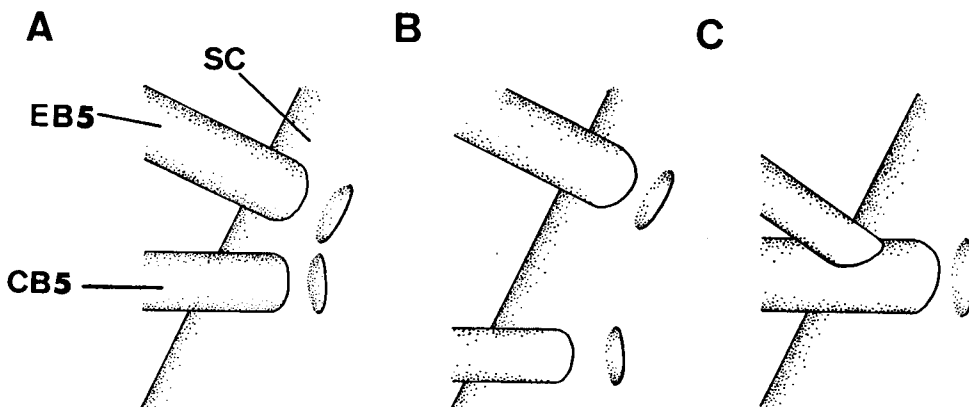

Fig. 33. Diagram showing the three patterns of articulation between last branchial arch and scapulocoracoid. A, articular faces for last epi- and cerato-branchial cartilages closely located; B, articular faces apart; C, only one face. SC, scapulocoracoid; 5-CB, 5th ceratobranchial cartilage; 5-EB, 5th epibranchial cartilage.

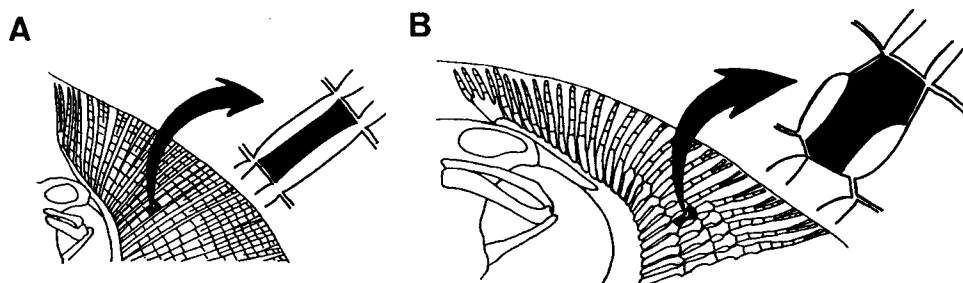

Fig. 34. Pectoral radials. A, *Urotrygon mundus*; B, *Gymnura japonica*.

of the distal ends of the last epibranchial and ceratobranchial cartilages are located on the inner side of the scapulocoracoid. These two condyles are closely located in most myliobatidoids (Fig. 33A), but are more separated in *Myliobatis*, *Aetobatus*, *Aetomylaeus*, *Rhinoptera*, *Mobula* and *Manta* (Fig. 33B). In out-group taxa, two condyles are closely located (Fig. 33A) or reduced to a single for the last ceratobranchial cartilage (Fig. 33C).

In myliobatidoids, the scapular process (dorsal tip of the scapulocoracoid) firmly articulates with the lateral face of the synarcual. The suprascapulae are fused to both sides of the synarcual, forming a complex socket and condyle for articulation with the scapular process (see Chapter VI-1-5).

The pectoral fins typically form a disc, supported by fanshaped skeletons. The

Fig. 32. Dorsal (upper) and lateral (lower) views of the scapulocoracoid. A, *Rhinoptera javanica*; B, *Mobula japonica*; C, *Raja pulchra*; D, *Rhinobatos hymnincephalus*; E, *Narke japonica*. For abbreviations, see Fig. 30. Scales indicate 10 mm.

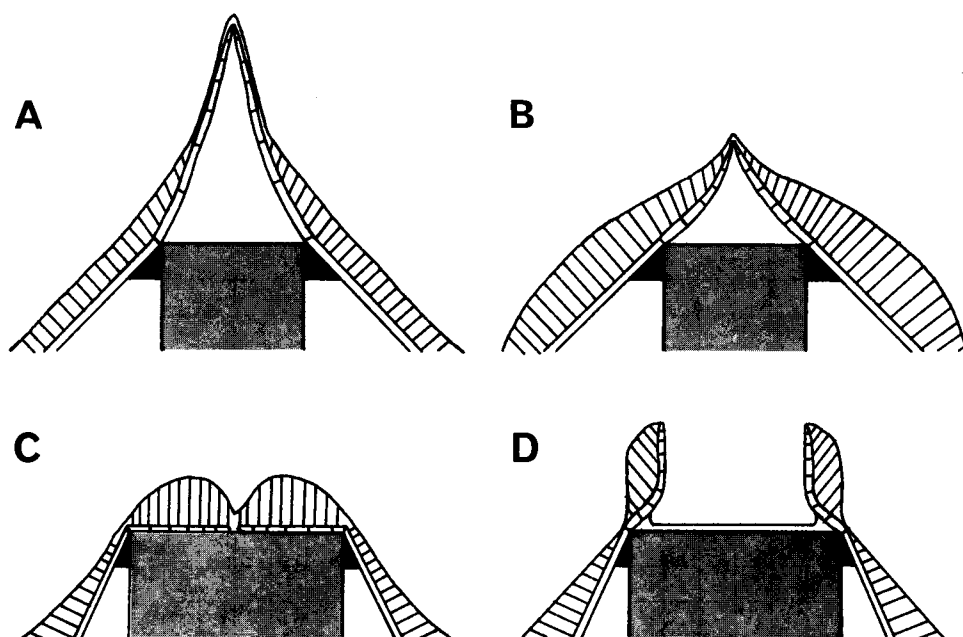

Fig. 35. Diagram showing the four patterns of skeletal support of the snout. A, rostral extensions of propterygia; B, typical myliobatidoid pattern; C, cephalic lobe; D, cephalic fin.

pectoral fin is supported by the scapulocoracoid, propterygium, mesopterygium, metapterygium and radials. The propterygium articulates with the anterior corner of the scapulocoracoid, and is directed anteriorly, with medial support from the antorbital and nasal capsule. The rostral extensions of the propterygium are usually divided into several segments. In *Mobula* and *Manta*, however, the propterygium is fused to the scapulocoracoid, and is not segmented. The number of mesopterygia varies from 0-4. The metapterygium, with several segments, extends to the posterior tip of the disc. These three pterygia, together with the scapulocoracoid, support the pectoral radials. The number of total pectoral radials also varies (Tab. 2). In *Gymnura*, *Aetoplatea*, *Myliobatis*, *Aetobatus* and *Aetomylaeus* (Fig. 34B), some pectoral radials supported by the propterygia, are articulate distally with the neighbouring radial, but this was not seen in other genera (Fig. 34A). The pectoral fins are plesodic in all myliobatidoids.

In most myliobatidoids, the anterior extensions of the pectoral fins form the snout. In *Aetobatus*, *Aetomylaeus*, *Rhinoptera*, *Mobula* and *Manta*, however, the pectoral fin radials are interrupted near the eye, to reappear in front of the head as the cephalic lobes. Each cephalic lobe comprises the rostral portion of the pectoral fin, and is entirely separated from the (lateral) pectoral fin. Basally the two lobes are continuous with one another (Fig. 35C). In *Mobula* and *Manta*, the lobe is very highly developed and is called the cephalic fin. The cephalic fins are widely separated and project forward from the head (Fig. 35D).

Table 2. Number of pectoral radials.

Species	Propterygium	Mesopterygium	Metapterygium	Total
<i>Urolophus halleri</i>	39	14	34	87
<i>U. maculatus</i>	41	9	32	82
<i>U. aurantiacus</i>	44	8~9	36~38	88~91
<i>U. testaceus</i>	48	12	38	98
<i>Urotrygon asterias</i>	42	11	37	90
<i>U. microphthalmum</i>	38	6	24	68
<i>U. mundus</i>	32	6	21	59
<i>Potamotrygon hystrix</i>	45	17	38	100
<i>P. yepezi</i>	38~46	10~13	31~34	80~90
<i>P. magdalenae</i>	42	13	30	85
<i>Taeniura lymna</i>	49	14	49	112
<i>T. meyeri</i>	55	17	54	126
<i>D. acutirostra</i>	52~55	18~21	56~60	129~135
<i>D. akajei</i>	45~48	12~16	44~46	106~112
<i>D. bennetti</i>	51	20	52	123
<i>D. brevis</i>	47	18	55	120
<i>D. izuensis</i>	42~45	11~15	45~50	102~105
<i>D. kuhlii</i>	41~44	15~17	50~51	106~112
<i>D. margaritella</i>	50	18	49	117
<i>D. matsubarai</i>	56	14	50	120
<i>D. pastinaca</i>	41~44	16~17	41~47	99~107
<i>D. sabina</i>	46	17	44	107
<i>D. say</i>	47	19	50	116
<i>D. zugei</i>	45~52	14~20	43~48	106~114
<i>Himantura bleekeri</i>	50	18	54	122
<i>Gymnura japonica</i>	37	7~10-8~11	48	103
<i>G. marmorata</i>	38	9-4-8	39	98
<i>G. poecilura</i>	35	10-4-8	44	101
<i>Aetoplatea zonura</i>	38	12-3-8	54	115
<i>Myliobatis aquila</i>	40	6-5-8	46	105
<i>M. goodei</i>	34~37	10~11-3~4-4-5~7	49~50	106~109
<i>M. tobije</i>	33	9-4-7	49	102
<i>Aetomylaeus nichofii</i>	17	4-14-3-8	41	87
<i>Mobula japonica</i>	45	0	93	138

*Discussion.* This region is one of the most extensively studied in rajoids (e.g., McEachran and Compagno, 1979; McEachran, 1984; McEachran and Miyake, 1987). McEachran (1984) identified several characters which he used for clarifying rajoid relationships. In addition, several important anatomical studies on the myliobatidoid scapulocoracoid, pectoral fin and cephalic fin have been published (Daniel, 1928; White, 1937; 1964; Compagno, 1977; Compagno and Roberts, 1982; Compagno and Heemstra, 1984). In this study, a number of characters have been identified, and their validities discussed herein.

**Scapulocoracoid:** The lateral face of the scapulocoracoid varies in myliobatidoids, but because changes are continuous, it is difficult to objectively distinguish between different states. Therefore this character is not suitable for phylogenetic analyses.

**Scapulocoracoid and propterygium:** In *Mobula* and *Manta*, the scapulocoracoid is anteriorly elongate and fuses with the propterygium, unlike other myliobatidoids and all out-group taxa, which have the propterygium short and articulating with the propterygium. An elongate scapulocoracoid, is considered to be the derived character state (character 102).

**Rostral extensions of propterygia:** In *Hexatrygon*, radials are absent from the rostral extensions of the propterygia. This condition does not occur in any other myliobatidoids or in out-group taxa. Radials absent from the rostral extensions of the propterygia is considered to be the derived character state (character 70).

**Number of mesocondyles:** As described above, the number of mesocondyles (for articulation of the mesopterygia) varies. Whereas in most out-group taxa, a single mesocondyle is present. Because some myliobatidoid species (e.g. *Gymnura japonica*, *Aetoplatea zonura*, *Myliobatis goodiei*) show intraspecific variation, the character is unsuitable for any phylogenetic analyses.

**Anterodorsal fenestra:** The number and condition of anterodorsal fenestrae varies in myliobatidoids and also in rajoids. On the other hand, the remaining rajiformes usually have a single fenestra. Structural differences found in the fenestrae are, however, very complicated, sometimes showing intraspecific variation (e.g., *Dasyatis akajei* and *Myliobatis tobijei*). Accordingly, this character is unsuitable for phylogenetic analysis, although as a rule anterodorsal fenestrae tend to be more complicated in myliobatidoids.

**Postdorsal fenestra:** In *Urolophus* and *Urotrygon* (except *Urotrygon daviesi*), a postdorsal fenestra is absent. In other myliobatidoids and in all out-group taxa, a postdorsal fenestra is present. Absence of the postdorsal fenestra is considered to be the derived character state (character 72).

**Condyle position for epibranchial and ceratobranchial cartilages:** In *Myliobatis*, *Aetomylaeus*, *Aetobatus*, *Rhinoptera*, *Mobula* and *Manta*, the condyles for the posteriormost epi- and ceratobranchial cartilages are well separated. In other myliobatidoids and in all out-group taxa, these two condyles are closely located. Well separated condyles are considered to be the derived character state (character 87).

**Number of pectoral radials:** As shown in Table 2, the number of total pectoral radials varies in myliobatidoids, from 59 (*Urotrygon mundus*) to 138 (*Mobula japonica*). Because changes are continuous, it is difficult to objectively distinguish

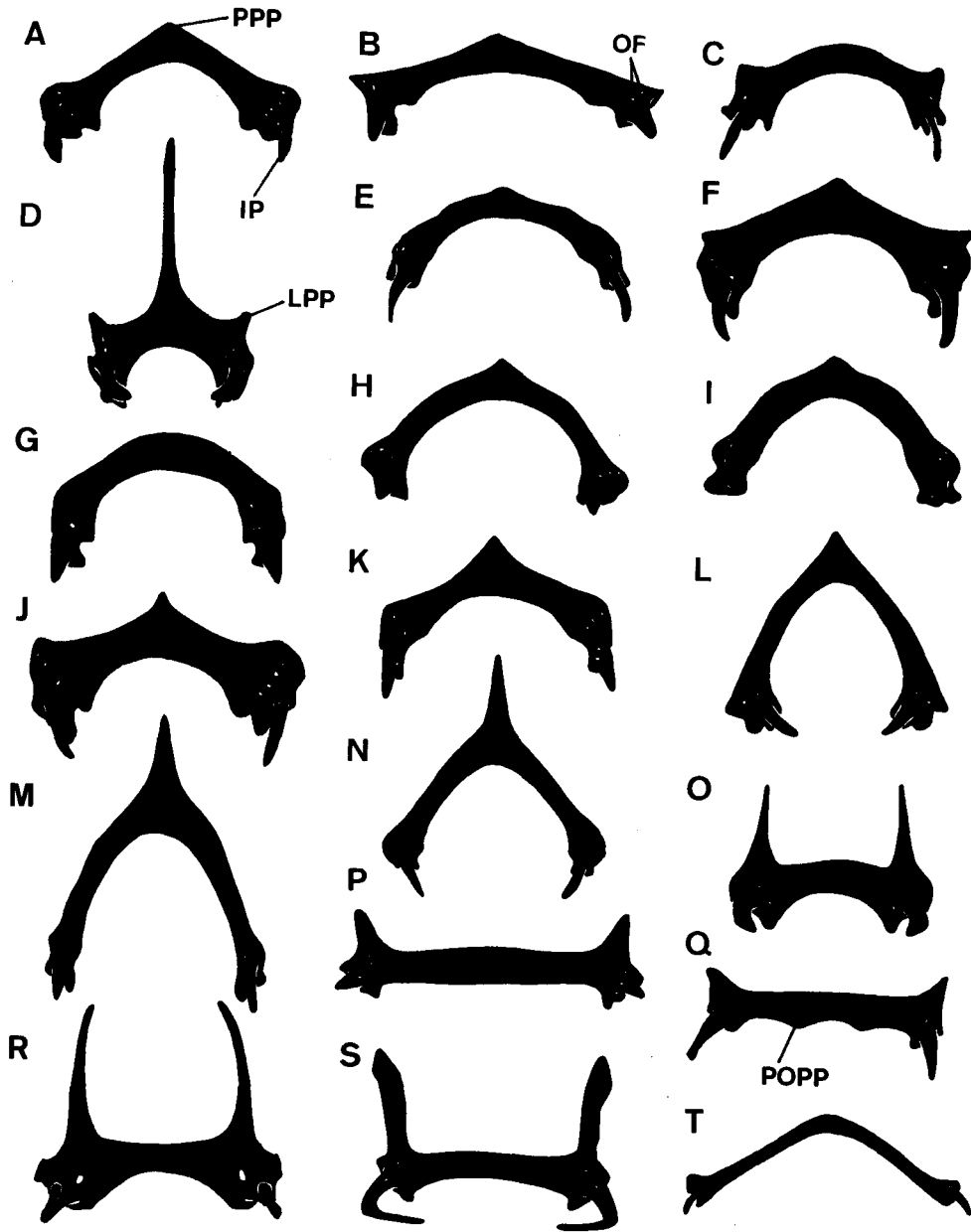

Fig. 36. Dorsal view of the pelvic girdle. A, *Urotrygon daviesi*; B, *Urolophus aurantiacus*; C, *Urotrygon mundus*; D, *Potamotrygon yepezi*; E, *Taeniura meyeri*; F, *Dasyatis akajei*; G, *Himantura bleekeri*; H, *Gymnura japonica*; I, *Aetoplatea zonura*; J, *Myliobatis goodei*; K, *Aetomylaeus nichofii*; L, *Aetobatus narinari*; M, *Rhinoptera javanica*; N, *Mobula japonica*; O, *Raja pulchra*; P, *Pssamobatis scobina*; Q, *Rhinobatus hynnicephalus*; R, *Platyrhina sinensis*; S, *Narke japonica*; T, *Rhynchobatus djiddensis*. IP, iliac process; LPP, lateral prepelvic process; OF, obturator foramen; POPP, postpelvic process; PPP, prepelvic process.

between different states. Therefore this character is not suitable for phylogenetic analyses.

Distal tip of pectoral radials: In *Gymnura*, *Aetoplatea*, *Myliobatis*, *Aetomylaeus* and *Aetobatus*, several pectoral radials supported by the propterygia, articulate distally with the neighbouring radial. In other myliobatidoids and in all outgroup taxa, this condition was not seen. Articulation of neighbouring pectoral radials is considered to be the derived character state (character 82).

Cephalic lobe: In *Aetomylaeus*, *Aetobatus*, *Rhinoptera*, *Mobula* and *Manta*, a cephalic lobe is present. In other myliobatidoids and in all out-group taxa, a cephalic lobe is absent. Presence of a cephalic lobe is considered to be the derived character state (character 96).

Cephalic fin: In *Mobula* and *Manta*, a cephalic fin is present. In other myliobatidoids and in all out-group taxa, a cephalic fin is absent. Presence of a cephalic fin is considered to be the derived character state (character 103).

#### 4) Pelvic girdle and pelvic fin.

*Description.* The pelvic girdle consists of a puboischiadic bar, prepelvic process (PPP), iliac processes (IP) and lateral prepelvic processes (LPP). The myliobatidoid puboischiadic bar is more or less anteriorly arched, with the lateral extremes a little swollen where the obturator foramina (OF) are located (Fig. 36A-N). The bar is strongly arched in *Aetobatus* (Fig. 36L), *Rhinoptera* (Fig. 36M), *Mobula* (Fig. 36N) and *Manta*, but not so much in other genera. The number of obturator foramina also varies (Tab. 3). In out-group taxa, the puboischiadic bar is generally plate-like, not being anteriorly arched (Fig. 36O-S). The prepelvic process (PPP) projects anteromedially from the anterior margin of the puboischiadic bar. This process is nearly absent in some species of *Urolophus*, *Urotrygon* (Fig. 36C), *Dasyatis*, *Himantura* (Fig. 36G), *Taeniura* (Fig. 36E), *Gymnura* (Fig. 36H) and *Aetoplatea* (Fig. 36I); triangle-shaped in *Myliobatis* (Fig. 36J), *Aetobatus* (Fig. 36L), *Aetomylaeus* (Fig. 36K), *Rhinoptera* (Fig. 36M), *Mobula* (Fig. 36N) and *Manta*; and extended bar-like in *Potamotrygon* (Fig. 36D). On the other hand, prepelvic process is absent from all out-group taxa (Fig. 36O-T). Although the degree of development varies, an iliac process (IP) is present on each lateral extremity of the puboischiadic bar in the Myliobatidoidei (Fig. 36A-N). This process is stout and directed dorsally, but is not so much developed as seen in the torpedinoid out-group (Fig. 36S). A short, stout, anterolaterally directed prepelvic process (LPP) is present on each anterolateral corner of the puboischiadic bar in *Potamotrygon* (Fig. 36D) and some species of *Urolophus* (Fig. 36B), *Urotrygon* (Fig. 36C), *Dasyatis* (Fig. 36F), *Himantura* and *Taeniura*. Whereas the lateral prepelvic process is reduced in all other myliobatidoid species, it is well developed in most out-group taxa (Fig. 36O-S). In *Platyrrhinoidis* and *Platyrrhina*, a postpelvic process (POPP) is present on the posterior edge of the puboischiadic bar (Fig. 36Q). The process was absent from the other rajiformes examined here (see character 50 of Chapter V-2).

The pelvic fin is plesodic in myliobatidoids, and is usually triangular, rather than bilobed as in rajoids. It is supported by the pelvic girdle, propterygium (PVP), metapterygium (PVM) and pelvic radials (PVR) (Fig. 37). A mesopter-

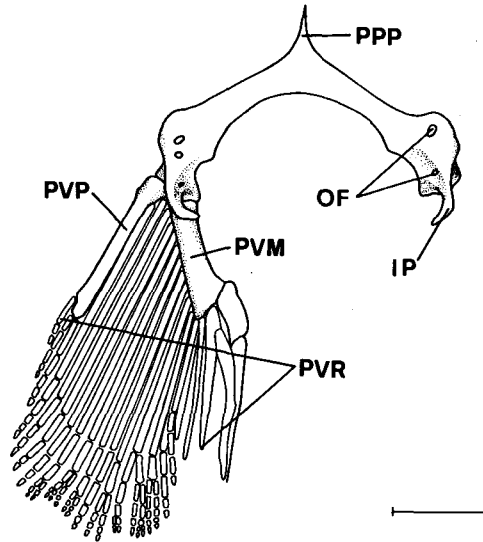

Fig. 37. Dorsal view of the pelvic girdle and fin of *Dasyatis pastinaca*. IP, iliac process; OF, obturator foramen; PPP, prepelvic process; PVM, pelvic metapterygium; PVP, pelvic propterygium; PVR, pelvic radials. Scale indicates 10 mm.

ygium is absent from the pelvic fin. Both the propterygium and metapterygium are bar-like cartilages, which articulate proximally with the posterolateral corner of the puboischiadic bar. The distal tip of the metapterygium is modified as the clasper in males (see Chapter VI-3). The number of pelvic radials varies as shown in Table 3, but generally the number in females is greater than in males. They articulate proximally with both the pterygia and (partly) the puboischiadic bar, and are divided into five to ten segments.

*Discussion.* The myliobatoid pelvic girdle has been described by, amongst others, Garman (1877, 1913), Compagno (1977), Capape and Desoutter (1979), Compagno and Roberts (1982, 1984), Compagno and Heemstra (1984), Rosa et al. (1987). The condition of the prepelvic process has long been regarded as an important character for the identification of myliobatoids (Garman, 1877; 1913; Bigelow and Schroeder, 1953; Thorson and Watson, 1975; Compagno and Roberts, 1984), but the pelvic girdle itself, has not hitherto been used in myliobatoid phylogenetic studies. Several pelvic girdle and fin characters are described below.

*Puboischiadic bar:* Anteriorly, the puboischiadic bar is variously arched in myliobatoids. In *Aetobatus*, *Rhinoptera*, *Mobula* and *Manta*, it is strongly arched, whereas in *Urolophus*, it is slightly arched. The condition, however, changes continuously and it is difficult to objectively distinguish between states. Accordingly, this character is unsuitable for phylogenetic analyses.

*Number of obturator foramina:* As shown in Table 3., this character shows intraspecific variation, and is not therefore suitable for phylogenetic analyses.

*Triangular prepelvic process:* In *Myliobatis*, *Aetobatus*, *Aetomylaeus*, *Rhinoptera*, *Mobula* and *Manta*, the prepelvic process is triangular and relatively long. In

Table 3. Number of pelvic radials and obturator foramina.

Species	Pelvic radials in male left-right	Pelvic radials in female left-right	Obturator foramina left-right
<i>Urolophus halleri</i>	18-18		
<i>U. maculatus</i>	18-19		
<i>U. aurantiacus</i>	20-20		2-2~3
<i>U. testaceus</i>	22-22	26-26	2-2
<i>Urotrygon asterias</i>	20-19		
<i>U. microphthalmum</i>	15-15		
<i>U. mundus</i>	14-14		
<i>Potamotrygon castexi</i>	20-21		
<i>P. magdalenae</i>	16-15		
<i>P. yepezi</i>	18~20-18~19		3-3
<i>Taeniura lymna</i>	22-23		
<i>T. meyeri</i>	22-22		1-2
<i>Dasyatis acutirostra</i>	23~25-24~25	26~28-26~28	
<i>D. akajei</i>	23~25-22~25	27~29-27~29	3~4-2~3
<i>D. bennetti</i>	21-21		
<i>D. brevis</i>	23-24		
<i>D. centroura</i>		27-27	
<i>D. izuensis</i>	20~21-20~21	26~27-26~27	
<i>D. kuhlii</i>	21~22-21~22	26~27-26~28	3-3
<i>D. margaritella</i>	21-20		
<i>D. matsubarai</i>		27-27	3-2
<i>D. pastinaca</i>	18-18	24-24	2~3-2
<i>D. sabina</i>	20-19		
<i>D. say</i>	24-23		
<i>D. zugei</i>	17~19-18~19	20~22-20~23	
<i>Himantura bleekeri</i>	23-23		
<i>Gymnura altavela</i>	18-19		
<i>G. japonica</i>		20~23-20~23	3-2~3
<i>G. poecilura</i>	16-15		
<i>Aetoplatea zonura</i>	17-17	22-23	2-2
<i>Myliobatis goodei</i>	23~25-23~24		5~6-5~6
<i>M. tobijei</i>		28-28	4-3
<i>Aetomylaeus nichofii</i>	16-16		
<i>Rhinoptera javanica</i>		21-21	3-2
<i>Mobula japonica</i>	14-14		3-3

other myliobatidoids (except *Potamotrygon*, which has a long, bar-like prepelvic process) and all out-group taxa, this condition was not seen. Presence of a triangular prepelvic process is considered to be the derived character state (character 88).

Bar-like prepelvic process: In *Potamotrygon*, the prepelvic process is long and bar-like. This condition was not observed in other myliobatidoids or in out-group taxa. Presence of a bar-like prepelvic process is considered to be the derived character state (character 77).

Iliac process: The iliac process is well developed in *Potamotrygon*, *Dasyatis*, *Taeniura Myliobatis* and *Mobula*, but reduced in *Gymnura* and *Aetoplatea*. The condition, however, changes continuously and it is difficult to objectively distinguish between states. Accordingly, this character is unsuitable for phylogenetic analyses.

Lateral prepelvic process: In *Potamotrygon*, the lateral prepelvic process is relatively well developed, whereas in *Gymnura*, *Myliobatis* and *Mobula*, the process is nearly absent. The condition, however, changes continuously and it is difficult to objectively distinguish between states. Accordingly, this character is unsuitable for phylogenetic analyses.

Number of pelvic radials: As shown in Table 3, the number of pelvic fin radials varies in myliobatidoids, from 14 (*Urotrygon mudus* and *Mobula japonica*) to 29 (*Dasyatis akajei*). The number, however, changes continuously and it is difficult to objectively distinguish between states. Accordingly, this character is unsuitable for phylogenetic analyses. As mentioned in the description, sexual dimorphism in the number of pelvic radials is evident. Such dimorphism may have resulted from modification of the pelvic skeleton to clasper elements in males.

##### 5) Vertebrae, dorsal fin and caudal fin

*Description.* The vertebrae can be grouped into several categories: first synarcual (FS), intersynarcual vertebrae (ISV), second synarcual (SS), monospondylous vertebrae, and diplospondylous vertebrae. In the Myliobatidoidei, the anteriormost vertebrae are secondarily fused, forming a plate-like, first synarcual (Figs. 38, 39). A similar first synarcual is also present in out-group taxa (Fig. 39C-E) (less developed and shorter in torpedinoids). Actual numbers of fused vertebrae can be established by counting spinal nerve foramina (SNF) on the lateral face of the synarcual. The first synarcual articulates anteriorly with the neurocranium by an odontoid process and two occipital condyles. The odontoid process (OTP) is anteriorly produced from the anteroventral corner of the first synarcual (Figs. 38, 39), and fits into the semicircular notch (AS) of the basal plate between the occipital condyles (OC) (Figs. 10-19). Spinal nerves which emerge from the spinal nerve foramina (SNF), run along spinal nerve canals (SNC) on the lateral surfaces of the first synarcual. A lateral stay (LS) projects dorsally from the ventrolateral side of the first synarcual. In the Myliobatidoidei, the arch-shaped suprascapulae are firmly fused posterodorsally on the first synarcual, and have a socket and condyle articulation with the scapular processes (Figs. 39, 39). Articulation of the latter varies in out-group taxa (Fig. 39C-E). The intersynarcual vertebrae (ISV) separate the first (FS) and second (SS) synarcuals. The second synarcual also comprises several fused vertebrae, and posteriorly gives way to monospondylous vertebrae.

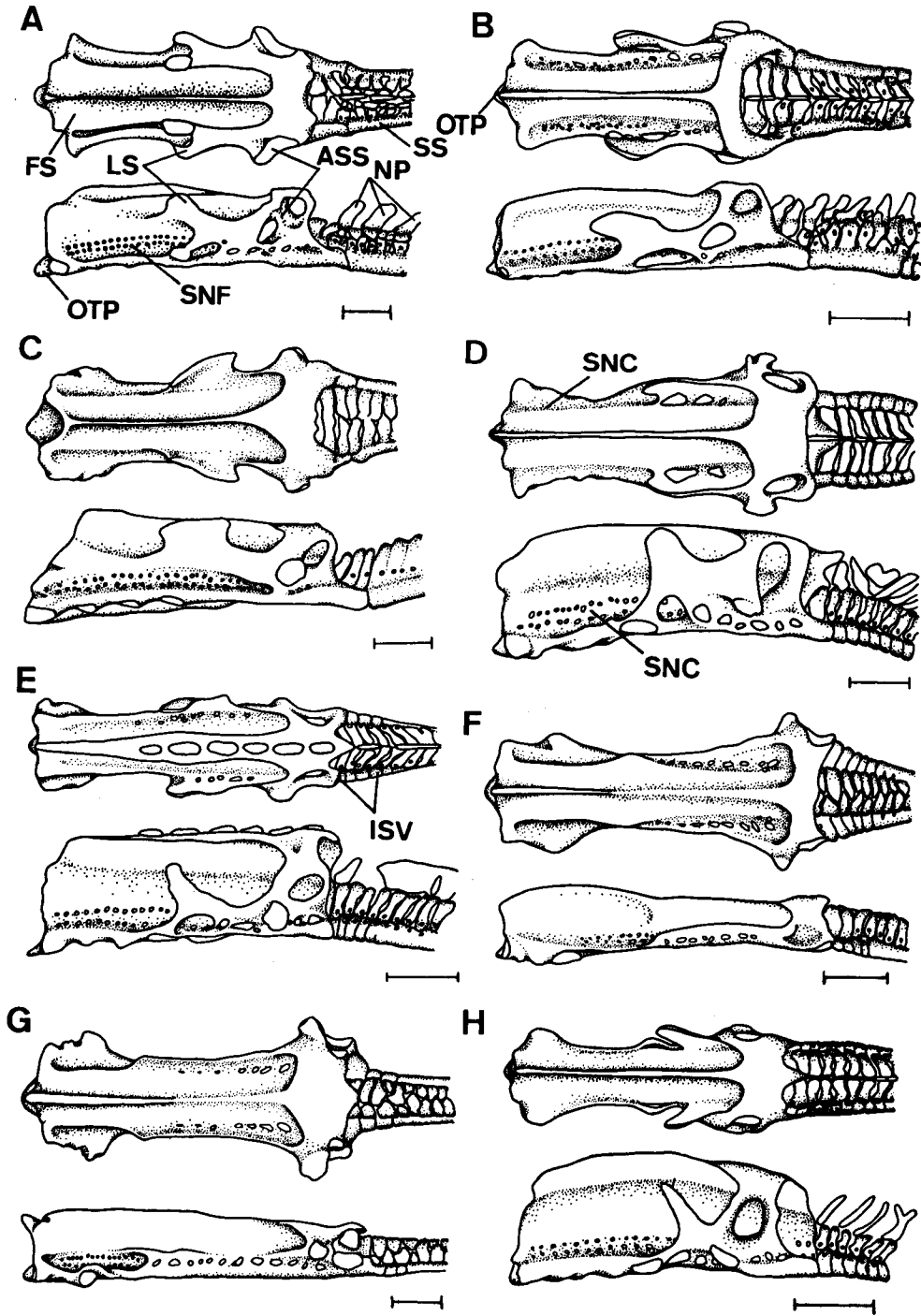

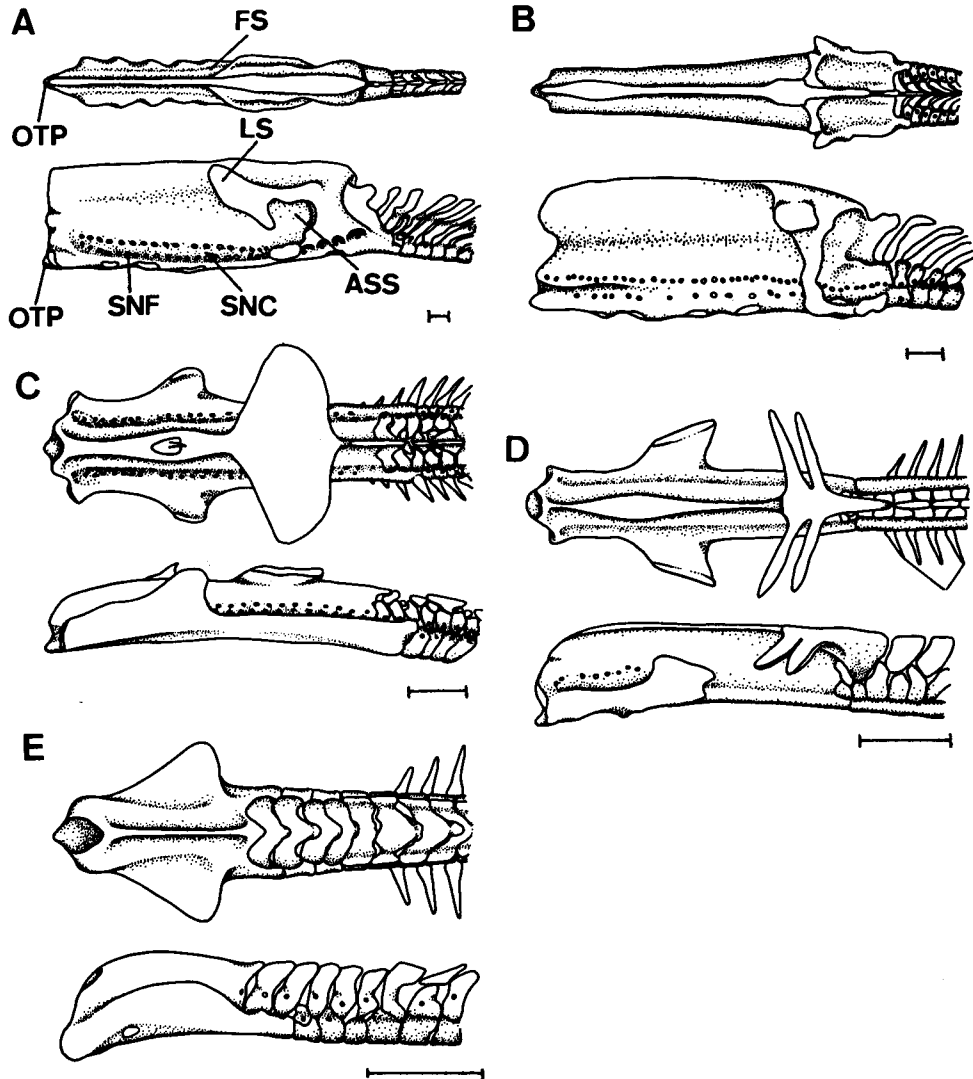

Fig. 39. Dorsal (upper) and lateral (lower) views of the first synarcual. A, *Rhinoptera javanica*; B, *Mobula japonica*; C, *Raja pulchra*; D, *Rhinobatos hynnicephalus*; E, *Narke japonica*. For abbreviations, see Fig. 38. Scales indicate 10 mm.

Fig. 38. Dorsal (upper) and lateral (lower) views of the first synarcual. A, *Urotrygon daviesi*; B, *Urolophus testaceus*; C, *Potamotrygon yepezi*; D, *Taeniura meyeri*; E, *Dasyatis kuhlii*; F, *Gymnura japonica*; G, *Aetoplatea zonura*; H, *Myliobatis tobijei*. ASS, articular surface for scapular process; FS, first synarcual; ISV, intersynarcual vertebrae; LS, lateral stay; NP, neural process; OTP, odontoid process; SNC, spinal nerve canal; SNF, spinal nerve foramen; SS, second synarcual. Scales indicate 10 mm.

Table 4. Number of prespine separate centra.

Species	
<i>Urolophus halleri</i>	86
<i>U. maculatus</i>	82
<i>Urotrygon asterias</i>	88
<i>U. microphthalmum</i>	70
<i>U. mundus</i>	72
<i>Potamotrygon castexi</i>	107
<i>P. hystrix</i>	95
<i>P. motoro</i>	102
<i>P. magdalenae</i>	106
<i>Taeniura lymna</i>	135
<i>Dasyatis acutirostra</i>	121-139
<i>D. akajei</i>	103-114
<i>D. bennetti</i>	119-121
<i>D. brevis</i>	124
<i>D. centroura</i>	153
<i>D. izuensis</i>	101-110
<i>D. kuhlii</i>	106-111
<i>D. margaritella</i>	115
<i>D. matsubarae</i>	113-129
<i>D. sabina</i>	117
<i>D. say</i>	116
<i>D. violacea</i>	94-99
<i>D. zugei</i>	95-100
<i>Himantura bleekeri</i>	111
<i>Myliobatis aquila</i>	129
<i>Aetomylaeus nichofii</i>	84

Diplospondylous vertebrae usually begin slightly posterior to the pelvic girdle, and continue to the tail tip in *Urolophus*, *Urotrygon* and *Hexatrygon*. In other myliobatidoids, however, the diplospondylous vertebrae are generally followed by an unsegmented, highly flexible rod. A neural process (NP) is usually present dorsally on each centrum, but it is more or less reduced and present only on the separate centra in *Gymnura* (Fig. 38F), *Aetoplatea* (Fig. 38G) and some species of *Potamotrygon* (Fig. 38C) and *Urotrygon*. The number of the prespine separate centra varies as shown in Table 4.

A dorsal fin is usually absent from the Myliobatidoidei, although a small plesodic dorsal fin is present in *Aetoplatea* (Fig. 40A), *Myliobatis* (Fig. 40B), *Aetobatus*, *Aetomylaeus*, *Rhinoptera* (Fig. 40C), *Mobula* (Fig. 40D) and *Manta*. The caudal fin is also absent from most myliobatidoids, except for *Hexatrygon*,

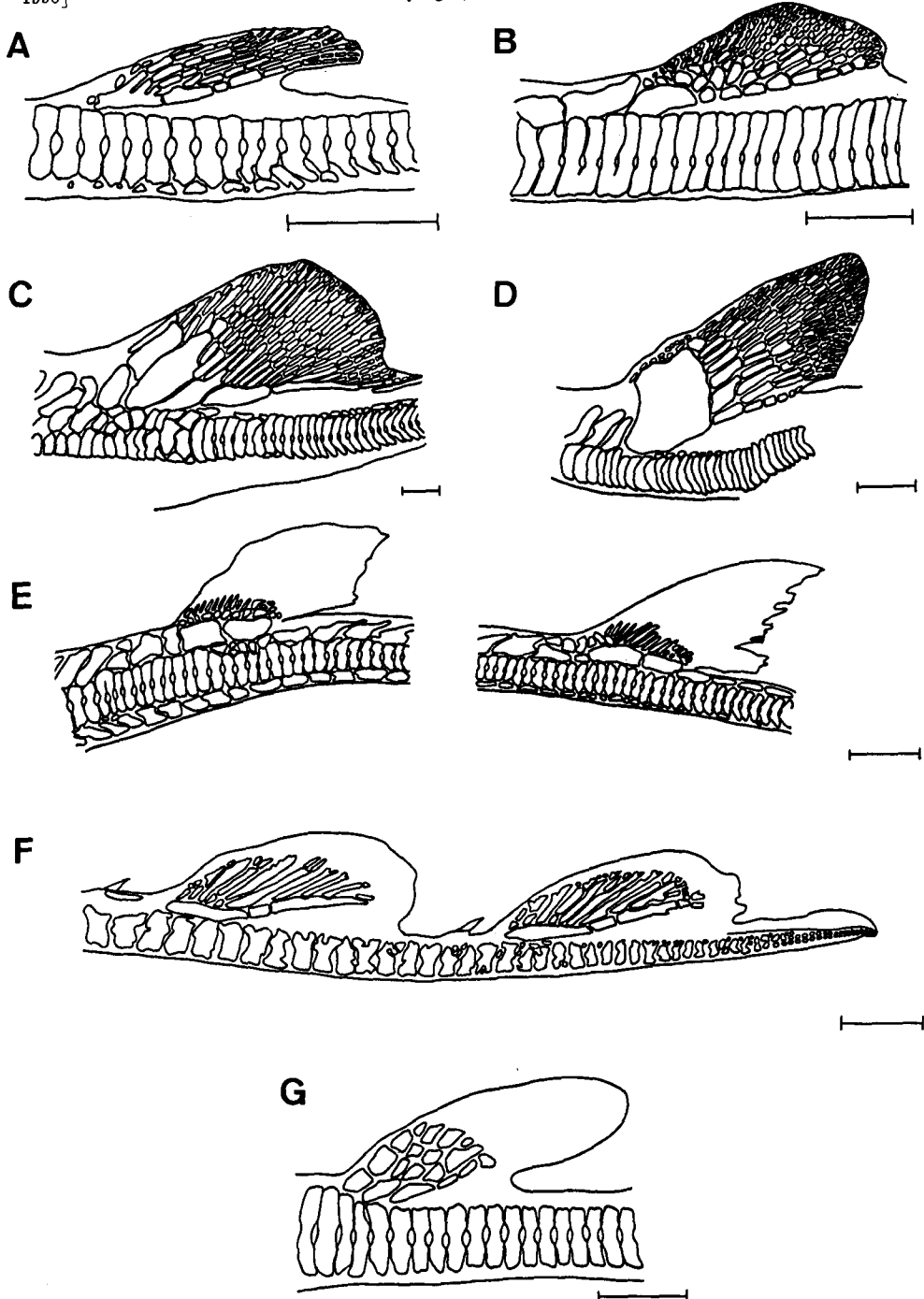

Fig. 40. Lateral view of the dorsal fin. A, *Aetoplatea zonura*; B, *Myliobatis tobijei*; C, *Rhinoptera javanica*; D, *Mobula japonica*; E, *Rhinobatos hynnicephalus*; F, *Raja pulchra*; G, *Narke japonica*. Scales indicate 10 mm.

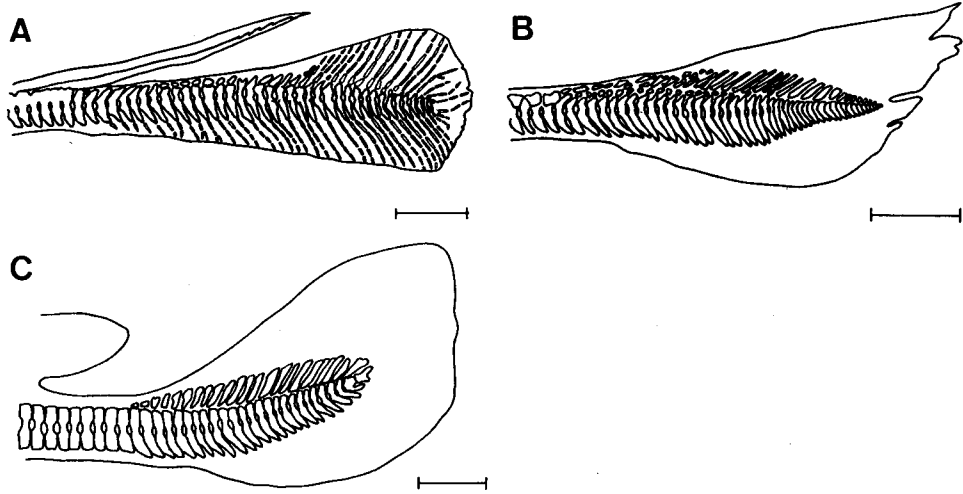

Fig. 41. Lateral view of the caudal fin. A, *Urolophus testaceus*; B, *Rhinobatos hymnicephalus*; C, *Narke japonica*. Scales indicate 10 mm.

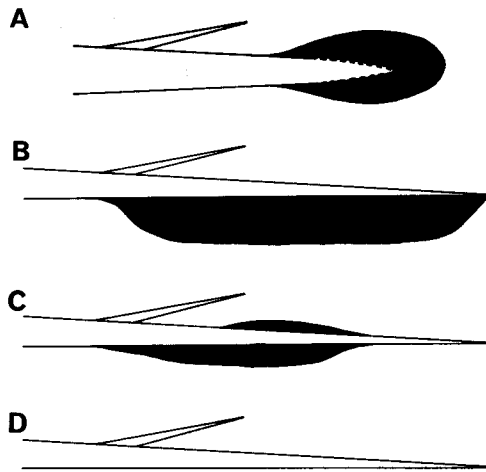

Fig. 42. Diagram showing the caudal tip of myliobatidoids. A, caudal fin; B, tail fold extending to tail tip; C, tail folds not extending to tail tip; D, without caudal fin or tail fold.

*Urotrygon* and *Urolophus* (Fig. 41A), and some genera in which tail folds persist. Both dorsal and caudal fins are usually present in out-group taxa (Figs. 40E-G; 41B, C, respectively). In *Taeniura* (Fig. 42B), a relatively high, ventral tail fold extends to the tip of the tail, and in *Potamotrygon*, both dorsal and ventral tail folds extend to the tail tip. In *Dasyatis* (Fig. 42C), dorsal and ventral folds are present, but do not extend to the tail tip. The ventral tail fold is supported by rudimental

radials in *Taeniura* and also in several species of the genus *Dasyatis*.

A tail spine (or spines) are usually present in myliobatidoids, but are absent from *Gymnura micrura*, *Aetomylaeus nichofi*, *Mobula diabolus*, and are completely covered by skin in adults of *Manta birostris*. In embryonic and young specimens of *Manta birostris*, however, a small tail spine can be observed, although it too is almost covered by skin (Gill, 1909; pers. obs.).

*Discussion.* There are several publications (Daniel, 1928; Melouk, 1949; Compagno, 1977) dealing with the vertebrae of rajiformes. In myliobatidoids, however, the vertebrae and accessory cartilages are poorly known. Owing to the seriousness of stingray attacks because of the poisonous tail spine, there are several studies (Coles, 1916; Halstead and Modglin, 1950; Holloway et al., 1953) on the spine. In this study, several morphological differences were found in the vertebrae and associated structures, some being suitable for phylogenetic analyses.

*Vertebrae:* In most myliobatidoids, the posterior section of the vertebral column is fused, forming an unsegmented rod. In *Hexatrygon*, *Urotrygon*, *Urolophus*, and in all out-group taxa, this sections not fused however, and diplospondylous vertebrae continue to the tip of the tail. Even so, in a specimen of *Gymnura micrura* (FSFL L801), segmentation of the vertebrae appeared to continue to the tail tip, although it was difficult to confirm, even by radiograph. The character was not considered suitable for analysis in this study, because more conclusive information was needed.

*Neural process:* In most myliobatidoids and in all out-group taxa, neural processes are well developed, beginning just posterior to the first synarcual. In *Gymnura*, *Aetoplatea*, *Urotrygon microphthalmum*, *Potamotrygon magdalenae*, *P. yepezi* and *P. motoro*, the processes are markedly reduced, and begin more posteriorly. Intermediate conditions were observed in the other species of *Urotrygon* and *Potamotrygon*, and it was difficult to objectively distinguish between states. Accordingly the character was considered unsuitable for phylogenetic analyses.

*Numbers of prespine separate centra:* As shown in Table 4., the number of prespine separate centra vary. Generally the number is fewer in *Urotrygon*, *Urolophus* and *Aetomylaeus* than in *Taeniura* and *Myliobatis*, with *Potamotrygon* and *Himantura* showing an intermediate range. Because the character changes continuously, and shows relatively wide intraspecific variation (e.g., 121-139 in *Dasyatis acutirostra* and 113-129 in *D. matsubarai*), it is considered unsuitable for phylogenetic analyses

*Dorsal fin:* In most myliobatidoids, a dorsal fin is absent. In *Aetoplatea*, *Myliobatis*, *Aetomylaeus*, *Aetobatus*, *Rhinoptera*, *Mobula* and *Manta*, however, a small plesodic dorsal fin is present. In most out-group taxa, two dorsal fins are present. Although reduction or complete loss of the dorsal fin is important in higher rajiform phylogeny (character 42), the significance of the presence or absence of a dorsal fin in myliobatidoids, is difficult to assess. Because of the differing positions of the dorsal fin in rajiforms (nearly at the tail tip in closely related, out-group rajoids; near the pelvic fins in rhinobatoids, except for *Rhynchobatus* and *Rhina*; and just above the pelvic fins or slightly posterior to them in myliobatidoids), homology of the dorsal fins in rajiforms is uncertain. The possibility that the dorsal fin is secondarily acquired in several myliobatidoids must be entertained. The

character is not suitable for the present myliobatidoid phylogenetic analysis.

**Caudal fin:** In *Hexatrygon*, *Urotrygon*, and *Urolophus*, and in most out-group taxa examined here, a caudal fin is present. In other myliobatidoids, it is either reduced to tail folds or is absent. Following the rule of "parsimony", it is considered that a reduction of the caudal fin to tail folds or complete loss, is considered to be the derived character state (character 56).

**Dorsal and ventral tail folds:** In *Dasyatis*, *Himantura*, *Gymnura*, *Aetoplatea*, *Myliobatis*, *Aetomylaeus*, *Aetobatus*, *Rhinoptera*, *Mobula* and *Manta*, tail folds, if present, do not reach the tail tip, unlike other myliobatidoids and all out-group taxa. The failure of tail folds, when present, to reach the tail tip, is considered to be the derived character state (character 79).

Of the above myliobatidoid genera (see character 79), only in *Dasyatis* are tail folds present, as they are (caudal fin or tail folds) in remaining myliobatidoids and in all out-group taxa. Therefore absence of tail folds is considered to be the derived character state (character 80).

**Tail spine:** In *Gymnura micrura*, *Aetomylaeus nichofii*, and *Mobula diabolus*, and in all out-group taxa, a tail spine is absent whereas it is present in other myliobatidoids. Embryonic and young examples of *Manta birostris* have a small spine almost covered by the skin, becoming completely covered in adults. It seems likely that the tail spine is subject to secondary reduction in *Manta birostris*. Because the condition was observed in but a single specimen of *Manta birostris*, more ontogenetic data are needed to confirm secondary loss of the tail spine in myliobatidoids. The character is not used for the phylogenetic analyses.

## 2. Muscles of the Myliobatidoidei

### 1) Head and visceral muscles

**Dorsal muscles:** Precranial muscles (PCM), absent from all other myliobatidoids and all out-groups (Fig. 43A), are found in *Gymnura* (Fig. 43B) and

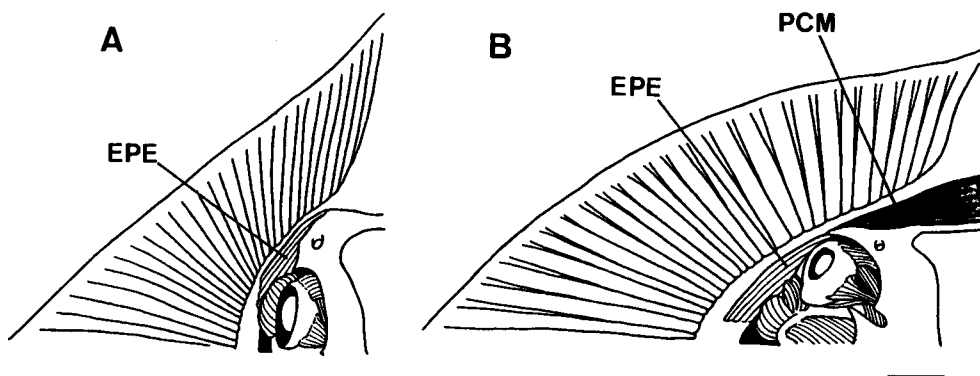

Fig. 43. Dorsal view of the head muscles (anterior part). A, *Himantura imbricata*; B, *Gymnura marmorata*. EPE, ethmoideo-parethmoidalis; PCM, precranial muscle. Scales indicate 10 mm.

*Aetoplatea*. These muscles originate from each anterolateral corner of the neurocranium and extend to the midline, where each fuses with its antimere via a median raphe. The ethmoideo-parethmoidalis (EPE) also originates from the anterolateral corner of the neurocranium, just over the origin of the precranial muscle in *Gymnura* and *Aetoplatea*, and passes posteriorly along the inner side of the pectoral propterygia, to be inserted on the inner side of the propterygium and antorbital cartilage. This muscle is present in all myliobatidoids and in most out-groups (Figs. 43, 45, 46).

The oculomotor muscles of the Myliobatidoidei comprise six parts (Fig. 44A-E). The superior and inferior obliques (SO and IO) originate from the posterior surface of the nasal capsule, just under the posterior foramen for the preorbital canal, and are inserted onto the upper and lower sides of the eyeball. In several myliobatidoid species, the superior oblique seems to be divided into two parts (Fig. 44C), but in other myliobatidoids and in all out-groups, such a condition is not observed (Fig. 44A, B, D-I). The superior, anterior, posterior and inferior recti (SR, AR, PR and IR) originate from the posterior part of the orbit, just surrounding the base of the eye stalk. The anterior rectus, the most slender oculomotor muscle extends anteriorly and is inserted onto the eyeball, just under the insertion of the superior oblique. In some myliobatidoids (Figs. 44B, D), the superior rectus originates on the anterior distal tip of the postorbital process, and divides before its insertion onto the eyeball. The inferior rectus passes along the eye stalk and is inserted onto the ventral side of the eyeball, just under the insertion of the inferior oblique. All of the oculomotor muscles are somewhat reduced in *Hexatrygon* (Fig. 44A), but generally, condition of the oculomotor muscles are similar in both myliobatidoids and out-group taxa.

The adductor mandibularis (AM) originates from the dorsal side of the palatoquadrate cartilage and extends anteroventrally (Figs. 45B, 46; see ventral muscle descriptions). The levator hyomandibulae (LHM) originates from the lateral wall of the neurocranium just posterior to the base of the postorbital process, and runs anterolaterally along the dorsal surface of the hyomandibular cartilage (HM), before inserting onto the dorsal surface of the hyomandibular cartilage (Fig. 45A). The levator spiracularis (LS) originates just under the origin of the levator hyomandibulae, runs anterolaterally, and is inserted onto the distal tip of the hyomandibular cartilage (Fig. 45B). Dorsally and anteriorly, this muscle covers the prespiracular cartilage, and forms the anterior wall of the spiracle. The levator palatoquadrati (LP) originates laterally just under the postorbital process, and extends anteriorly under the oculomotor muscles, before it is inserted onto the dorsal side of the palatoquadrate cartilage. The above muscles (AM, LHM, LS and LP) are generally similar in both myliobatidoids and their out-groups.

A dorsal longitudinal muscle bundle (DLB) usually originates from the posterodorsal corner of the neurocranium and extends posteriorly along the dorsal side of the vertebrae (Figs. 45A, 47A). However, it originates more anteriorly in *Rhinoptera* (Fig. 47B), *Mobula* and *Manta*. A pair of muscles, here named "neurocrania-synarcual muscle" (NSM), originates from the posteroventral corner of the neurocranium and is inserted onto the lateral surface of the first synarcual (Fig. 45B). In myliobatidoids, the cucullaris muscle (CC) originates from the lateral side of the first synarcual, just under the lateral stay, and runs posterolaterally to its insertion point, on the inner side of the scapulocoracoid cartilage (Fig. 45).

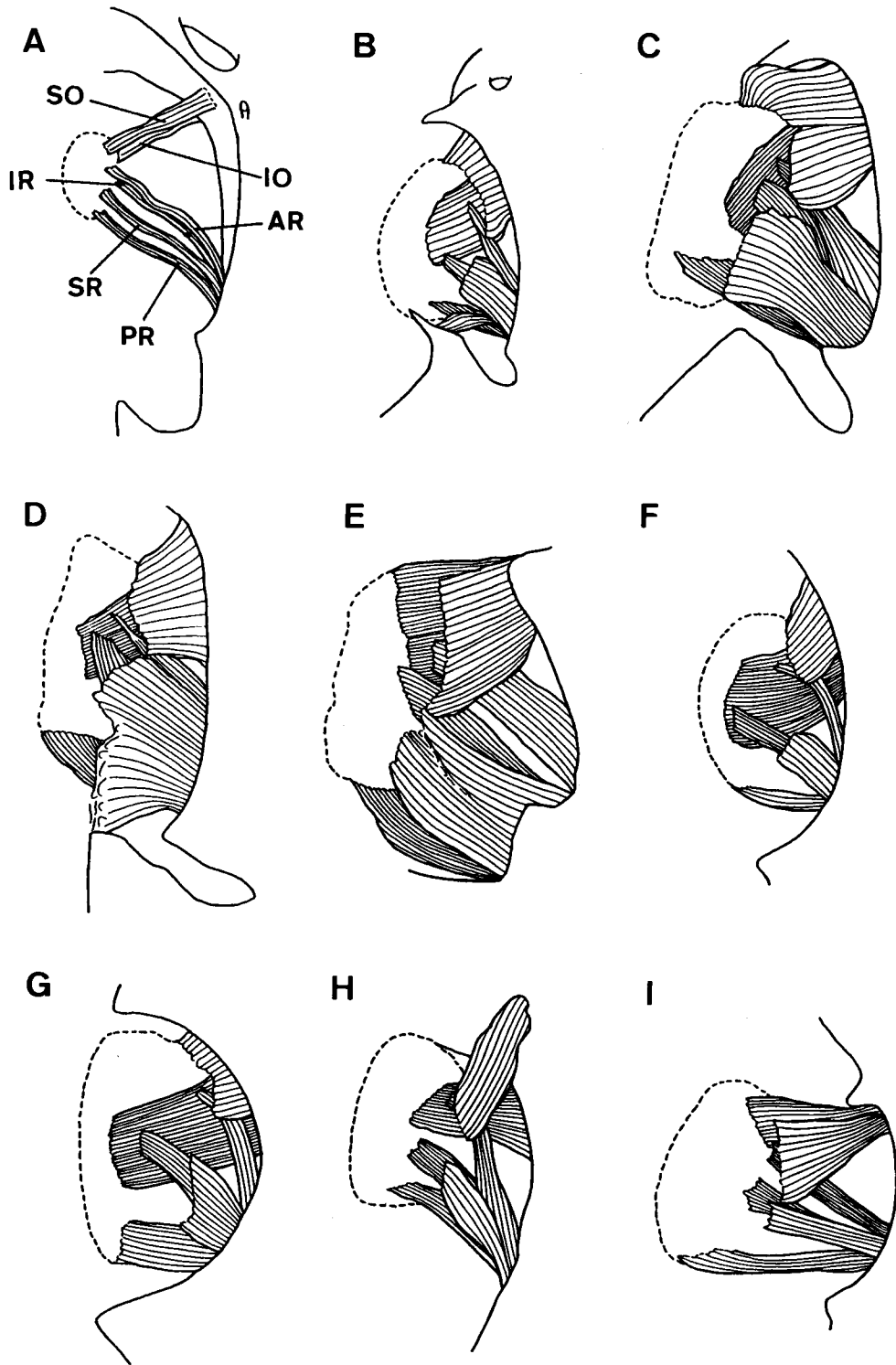

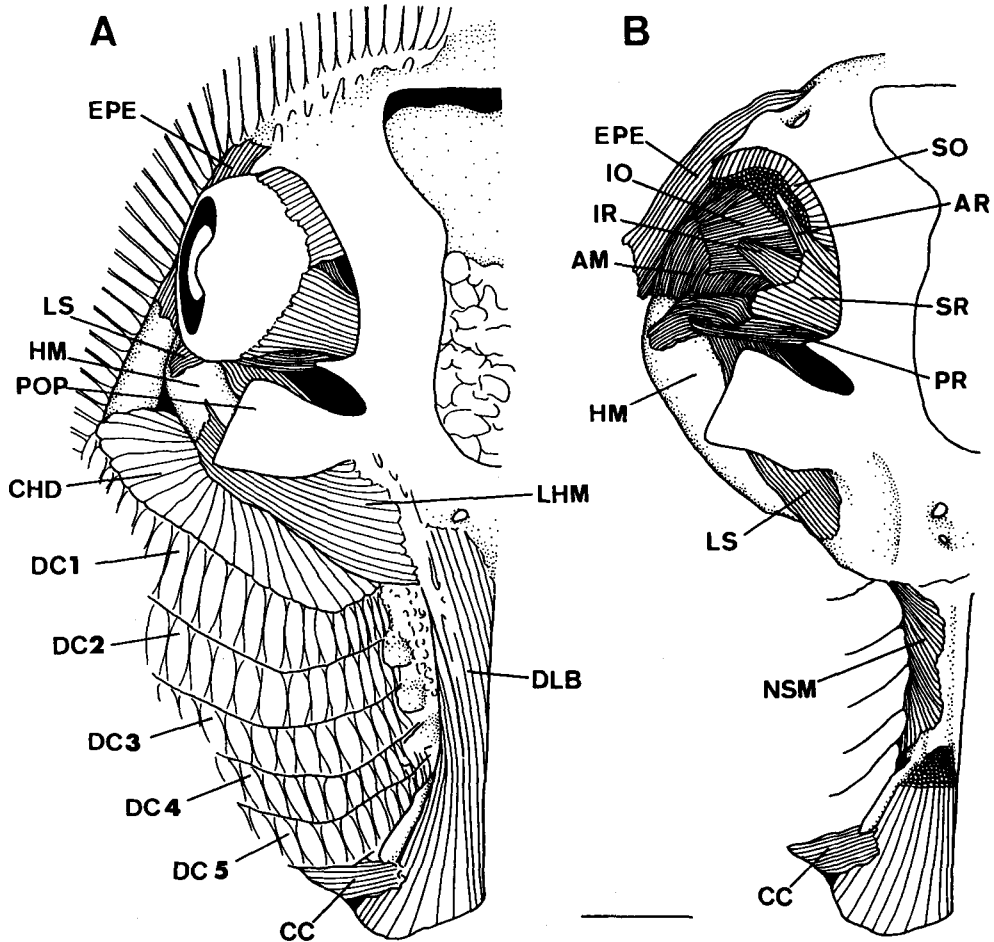
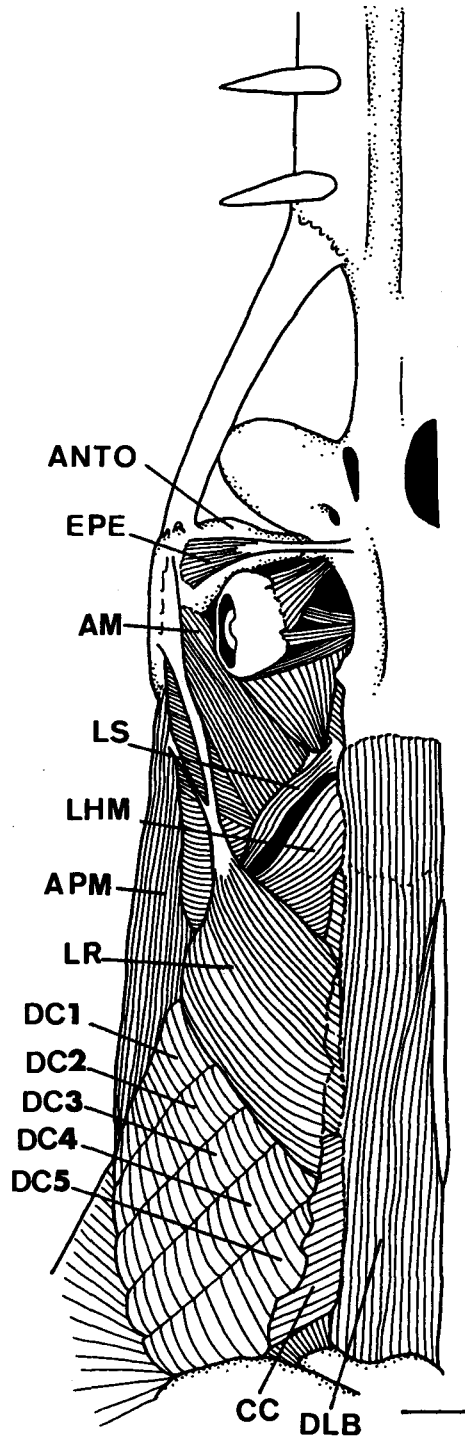

Fig. 45. A, Dorsal view of the head and visceral muscle of *Dasyatis izuensis*; B, Deeper dissection. AM, adductor mandibularis; CC, cucullaris; CHD, constrictor hyoideus dorsalis; DC1-5, dorsal constrictors 1-5; DLB, dorsal longitudinal bundles; EPE, ethmoideo-parethmoidalis; HM, hyomandibular cartilage; LHM, levator hyomandibulae; LS, levator spiracularis; MB, muscle B; POP, postorbital process; PTP, pectoral propterygium. Scale indicates 10 mm.

Fig. 44. Oculomotor muscles. Broken line indicates the eyeball. A, *Hexatrygon longirostra*; B, *Urolophus maculatus*; C, *Dasyatis brevis*; D, *Myliobatis aquila*; E, *Manta birostris*; F, *Rhinoraja longicauda*; G, *Trygonorhina fasciata*; H, *Narcine brasiliensis*; I, *Pristis microdon*. AR, anterior rectus; IO, inferior oblique; IR, inferior rectus; PR, posterior rectus; SO, superior oblique; SR, superior rectus.



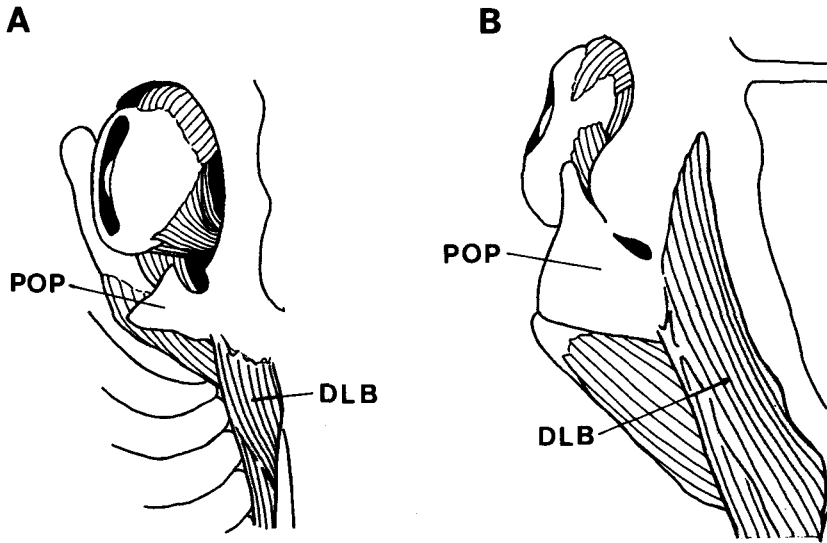

Fig. 47. Condition of the dorsal longitudinal bundles in two myliobatidoids. A, *Taeniura lymna*; B, *Rhinoptera bonasus*. DLB, dorsal longitudinal bundles; POP, postorbital process.

The dorsal constrictor muscles (DC1-5) are generally similar in both myliobatidoids and their out-groups (Figs. 45A, 46), usually numbering five (six in *Hexatrygon*). Membranes between the constrictor muscles provide both origin and insertion surfaces, each muscle running anteriorly from its origin. The constrictor hyoideus dorsalis (CHD) is the most anteriorly situated muscle in the branchial region. It originates from the membrane anterior to dorsal constrictor 1, runs ventrally to form the anterior wall of the branchial region, and is inserted onto the membrane separating the dorsal and ventral constrictor hyoideus muscles.

*Ventral muscles*: The depressor rostri muscle (DR) is the most superficial muscle of this region, being a thin, flat muscle originating from the membrane covering the genio-coracoideus (GC) and connecting the latter with its antimere. The depressor rostri anterolaterally, usually being converted into a thin tendon, which is inserted onto the pectoral propterygium, just anterior to the nasal capsule (Figs. 48A, 49A). In *Gymnura*, *Aetoplatea* and *Manta*, however, the muscle fibers are inserted directly onto the pectoral propterygium (Fig. 49B). In out-group taxa, the muscle is inserted more anteriorly onto the pectoral propterygium, nearly reaching the snout tip.

The adductor mandibulae medialis (AMM) originates from the ventral side of the mandibular cartilage, near the symphysis, and runs laterally to anteriorly form the corner of the mouth. It is inserted onto the ventral side of the palatoquadrate

Fig. 46. Dorsal view of the head and visceral muscles of *Pristis microdon*. ANTO, antorbital cartilage; APM, antorbit-pectoral muscle; LR, levator rostri. For other abbreviations, see Fig. 45. Scale indicates 10 mm.

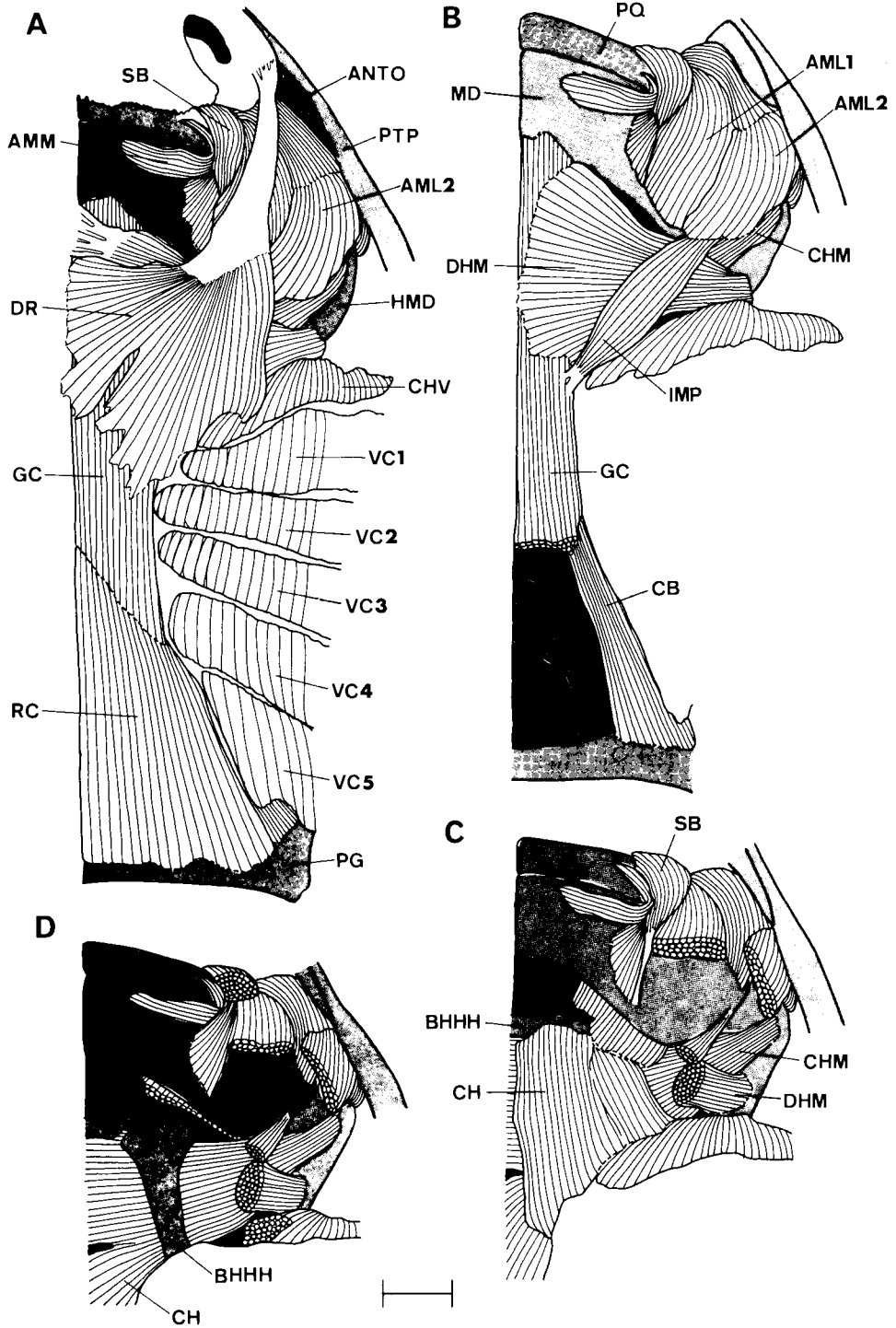

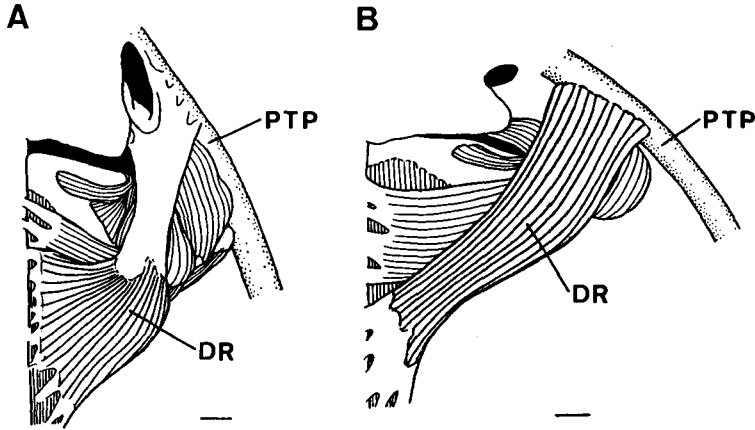

Fig. 49. Condition of the depressor rostri in two myliobatidoids. A, *Dasyatis sabina*; B, *Gymnura marmorata*. DR, depressor rostri; PTP, pectoral propterygium. Scales indicate 10 mm.

cartilage (Fig. 48). The suborbitalis (SB) originates from the posterior wall of the nasal capsule, running posteroventrally (Fig. 48A, C), before it is inserted via a tendon onto the posteroventral corner of the mandibular cartilage near the insertion of the intermandibularis posterior muscle (Fig. 48C). A similar condition is observed in most out-group taxa (Fig. 50A, B), although in *Rhina*, insertion is directly by muscle fibers (Fig. 51B). The insertion point of the suborbitalis is usually covered by the adductor mandibulae lateralis 1 (Fig. 48B, C), but incompletely so in *Hexatrygon* (Fig. 51A). The adductor mandibulae lateralis 1 muscle (AML1) is thick and broad, originating from the dorsal side of the palatoquadrate cartilage, and inserting onto the ventral side of the mandibular cartilage. It tightly covers the articulation of the palatoquadrate and mandibular cartilages (Fig. 48B). Adductor mandibulae lateralis 2 (AML2), the largest adductor muscle (Fig. 48A, B). It originates from the dorsal side of the palatoquadrate cartilage, runs ventrally to cover the jaw articulation with adductor mandibulae lateralis 1, and is inserted onto the ventral side of the mandibular cartilage. The adductor muscles are generally similar in both myliobatidoids and their out-groups.

The intermandibularis posterior muscle (IMP) originates from the membrane

Fig. 48. A, Ventral view of the head and visceral muscles of *Urolophus maculatus*; B, Deeper dissection; C, Deeper dissection; D, Deeper dissection. AML 1 & 2, adductor mandibulae lateralis 1 & 2; AMM, adductor mandibulae medialis; ANTO, antorbital cartilage; BHHH, basihyoid and hypohyoid cartilages; CB, coraco-branchiales; CH, coraco-hyoideus; CHM, coraco-hyomandibularis; CHV, constrictor hyoideus ventralis; DHM, depressor hyomandibulae; DR, depressor rostri; GC, geniocoracoides; HMD, hyomandibular cartilage; IMP, intermandibularis posterior; MD, mandibular cartilage; PG, pectoral girdle; PQ, palatoquadrate cartilage; PTP, pectoral propterygium; RC, rectus-cervicis; SB, suborbitalis; VC1-5, ventral constrictors 1-5. Scale indicates 10 mm.

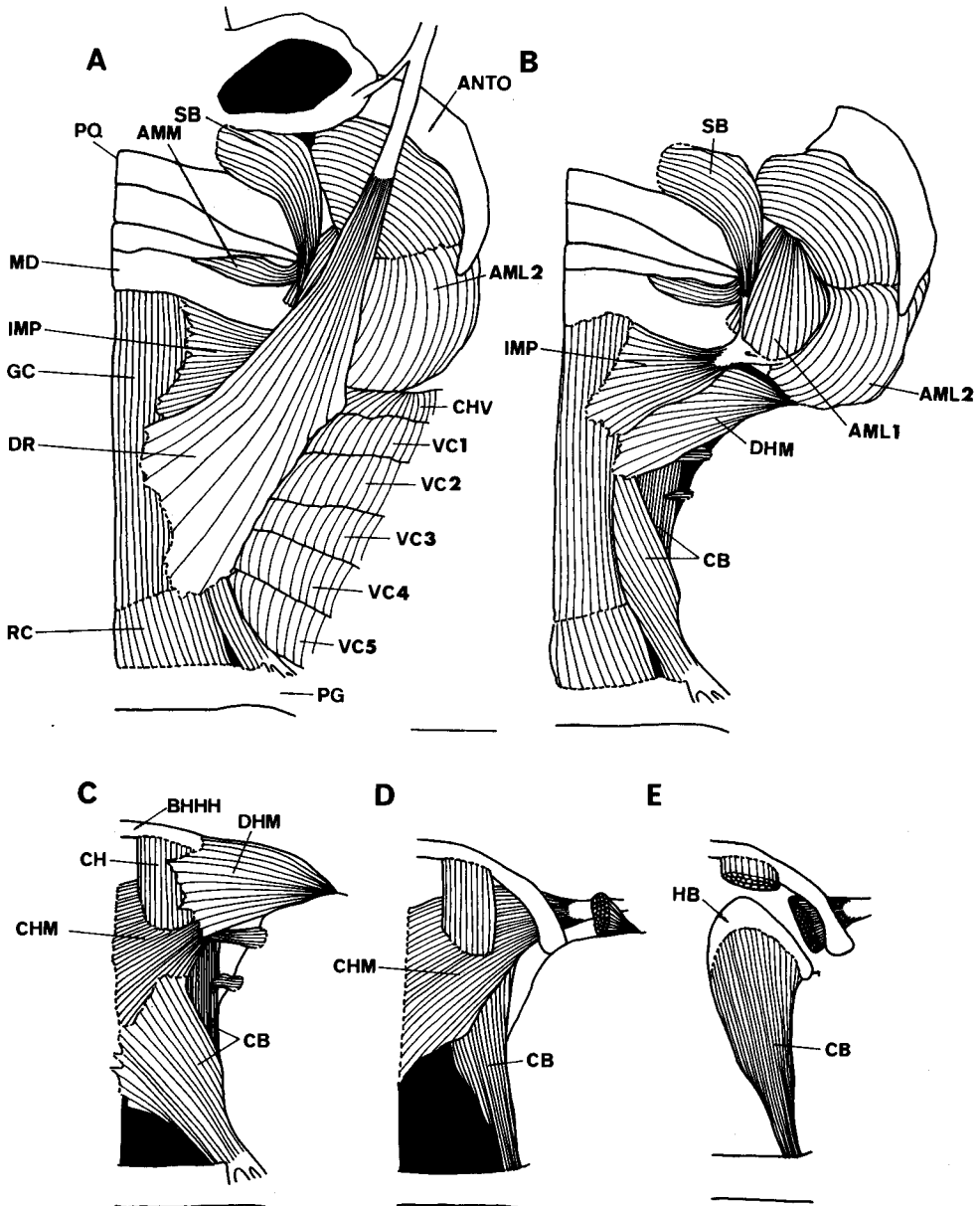

Fig. 50. Ventral view of the head and visceral muscles of *Aptychotrema vincentiana*. Sections A-E show progressively deeper dissections of the same region. HB, hypo-branchial cartilage. For other abbreviations, see Fig. 48. Scale indicates 10 mm.

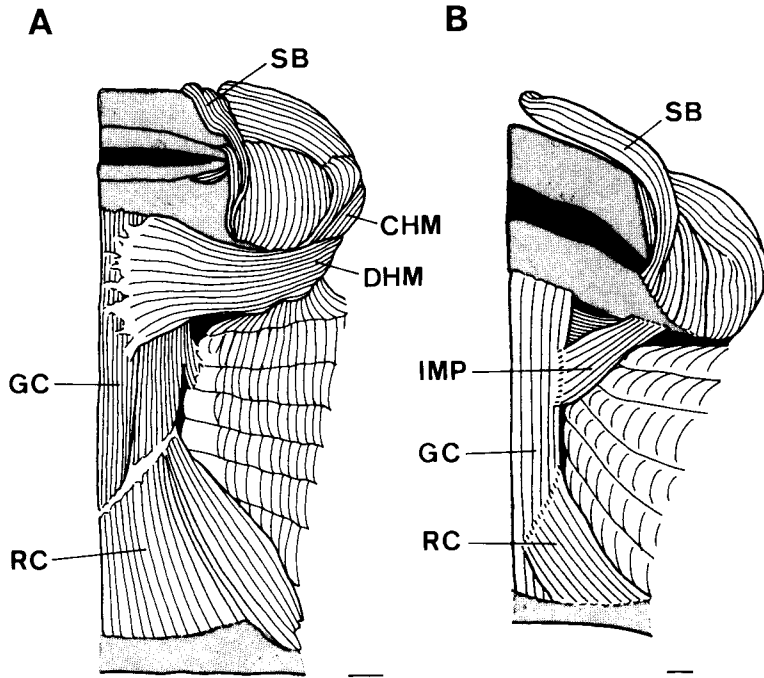

Fig. 51. Ventral view of the head and visceral muscles (depressor rostri removed). A, *Hexatrygon longirostra*; B, *Rhina ancylostoma*. For abbreviations, see Fig. 48. Scales indicate 10 mm.

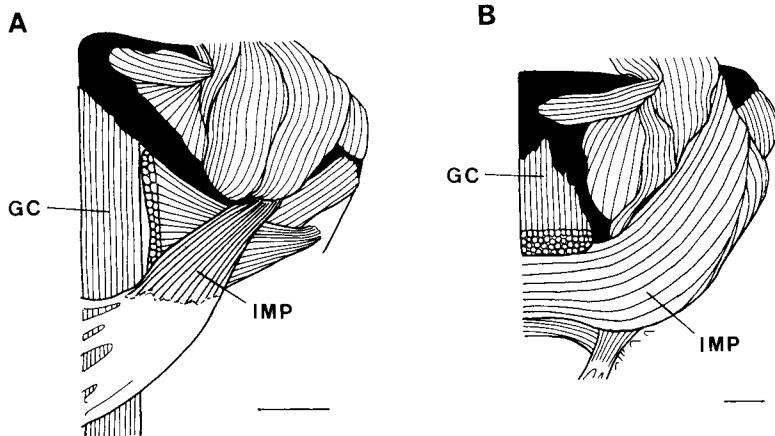

Fig. 52. Condition of the intermandibularis posterior in two myliobatidoids. A, *Urotrygon asterias*; B, *Myliobatis aquila*. For abbreviations, see Fig. 48. Scales indicate 10 mm.

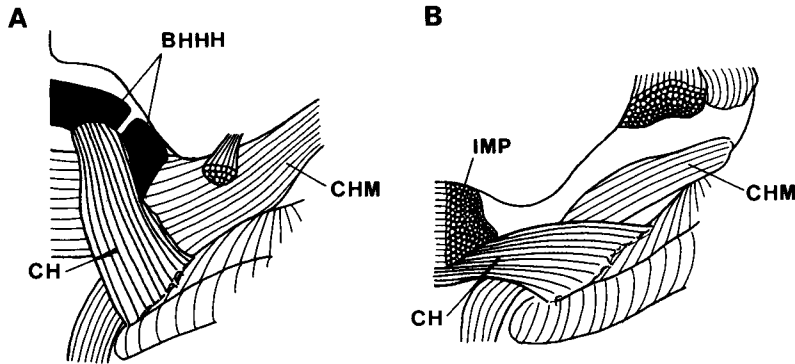

Fig. 53. Condition of the coraco-hyoideus in two myliobatidoids. A, *Potamotrygon magdalenae*; B, *Myliobatis aquila*. BHHH, basihyoid and hypohyoid cartilages; CH, coraco-hyoideus; CHM, coraco-hyomandibularis; IMP, intermandibularis posterior. Scales indicate 10 mm.

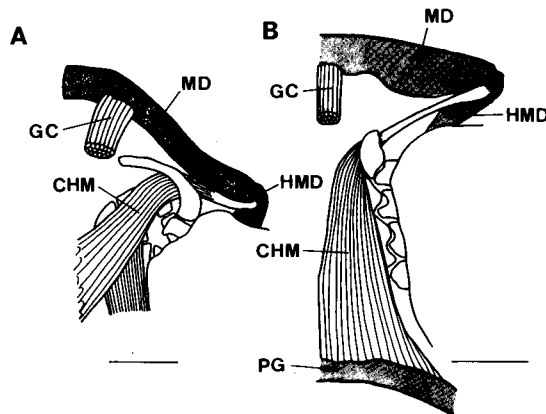

Fig. 54. Condition of the coraco-hyomandibularis in two torpedinoids. A, *Torpedo nobiliana*; B, *Narcine brasiliensis*. CHM, coraco-hyomandibularis; GC, genio-coracoideus; HMD, hyomandibular cartilage; MD, mandibular cartilage; PG, pectoral girdle. Scales indicate 10 mm.

covering the genio-coracoideus, runs anterolaterally, and is inserted onto the posteroventral edge of the mandibular cartilage, near the insertion of adductor mandibulae lateralis 1 and 2 (Fig. 48B, C). Amongst myliobatidoids, it is absent only from *Hexatrygon* (Figs. 51A, 52). In *Myliobatis* (Fig. 52B), *Aetobatus*, *Aetomylaeus*, *Rhinoptera*, *Mobula* and *Manta*, both sides of the intermandibularis posterior are connected directly, running along the mandibular cartilage under the wing-like process (WP, Figs. 20J, 21). In other myliobatidoids (Fig. 52A), such a condition was not observed. The depressor hyomandibulae muscle (DHM) also originates from the membrane covering the genio-coracoideus and runs anterolaterally, but is

inserted onto the posterolateral corner of the hyomandibular cartilage (Fig. 48B). This muscle is generally similar in both myliobatidoids and their out-groups.

The genio-coracoideus muscle (GC) originates from a strong membrane, which associates it with the rectus-cervicis muscle, and runs anteriorly to its insertion on the posteroventral edge of the mandibular cartilage, near the symphysis. Although the muscle is relatively thin in *Hexatrygon*, it is generally similar in both myliobatidoids and their out-groups (except for *Rhina*, in which the muscle originates directly from the pectoral girdle; see Fig. 51B).

In myliobatidoids and their out-groups the rectus-cervicis muscle (RC) originates from the anteroventral edge of the pectoral girdle and is inserted onto the membrane covering the genio-coracoideus (Figs. 48A, 50A).

The coraco-hyoideus muscle (CH) usually originates from a membrane covering the 1st and 2nd branchial regions, runs anteriorly, and is inserted onto the ventral surface of the basihyoid and hypohyoid cartilages (Figs. 48C, 53A). In *Myliobatis*, *Aetobatus*, *Aetomylaeus*, *Rhinoptera*, *Mobula* and *Manta*, in which the basihyoid and hypohyoid cartilages (BHHH) are reduced, the muscle fuses with its antimere via a raphe (Fig. 53B). In out-group taxa, the coraco-hyoideus originates from a membrane covering the coraco-hyomandibularis (CHM) (Fig. 50C, D). The latter is a deep, divided muscle that anteriorly originates in the midline, where it is fused with its antimere via a raphe, and posteriorly originates from a membrane covering the ventral surface of the basibranchial cartilage. The muscle runs anterolaterally under the basihyoid and hypohyoid cartilages, and the depressor hyomandibulae, and is inserted onto the lateral corner of the hyomandibular cartilage just ventral to the insertion of the depressor hyomandibulae (Fig. 48D).

The coraco-branchiales muscle (CB) originates from the anterior surface of the pectoral girdle, lateral to the origin of the rectus cervicis (Fig. 48B), and running anteriorly, is divided into several parts. Each part is inserted onto the ventral surface of the basibranchial and each ceratobranchial cartilage. This condition is generally similar in both myliobatidoids and their out-groups.

The ventral constrictors muscles (VC1-5) are generally similar in both myliobatidoids and their out-groups (Figs. 48A, 50A), usually numbering five (six in *Hexatrygon*). As with dorsal constrictors 1-5, membranes between the ventral constrictor muscles provide both origin and insertion surfaces, each muscle running anteriorly from its origin. The constrictor hyoideus ventralis muscle (CHV) originates from the membrane anterior to ventral constrictor 1, runs dorsally to from the anterior wall of the branchial region, and is inserted onto the membrane separating the dorsal and ventral constrictor hyoideus muscle.

*Discussion.* Several studies of myliobatidoid muscles have been published (Marion, 1905; Luther, 1909; Edgeworth, 1935; Lamarca, 1964; Andres et al., 1985), but are limited to partial dissections and descriptions of a few species only. In this study, several significant differences were found in the head and visceral muscles.

Precranial muscle (PCM): Reported for the first time in this work, the precranial muscle is known only from *Gymnura* and *Aetoplatea*, and may be an extension of the ethmoideo-paraethmoidalis. Presence of a precranial muscle is considered to be the derived character state (character 83).

Superior oblique (SO) : In several myliobatidoids, the superior oblique muscle appears to be divided into two parts. A similar condition was observed in some out-group taxa, but overall the division was unclear and assessment difficult. The character was not, therefore, considered suitable for phylogenetic analyses.

Postorbital branch of superior rectus (SM) : In some species of *Urotrygon*, *Urolophus*, *Dasyatis*, *Himantura*, *Myliobatis* and *Rhinoptera*, a postorbital branch of the superior rectus muscle is present. In other myliobatidoids and in all out-group taxa, this branch was not observed. Both conditions, however, were observed within a species (e.g. *Urolophus aurantiacus*, *Myliobatis goodei*, *M. tobijei*), and on the basis of such intraspecific variation, the character is considered unsuitable for phylogenetic analyses.

Dorsal longitudinal bundles (DLB) : In most myliobatidoids and in all out-group taxa, the dorsal longitudinal bundles originate from the posterodorsal corner of the neurocranium. In *Rhinoptera*, *Mobula* and *Manta*, however, the muscle originates from a more anterior part of the neurocranium. Origin of the dorsal longitudinal bundles from the anterior part of the neurocranium, is considered to be the derived character state (character 100).

Number of dorsal constrictors (DC) : Alone amongst myliobatidoids and their out-groups, *Hexatrygon* has six dorsal constrictor muscles (usually number five). Although a significant difference, it is clear that the number of dorsal constrictors is related to the number of branchial arches (character 68). Thus it is considered to have equal phylogenetic significance with character 68, and is excluded from phylogenetic analysis, so as to avoid character weighting.

Depressor rostri (DR) : In most myliobatidoids and in all out-group taxa, the depressor rostri is inserted via a tendon onto the pectoral propterygium. In *Gymnura*, *Aetoplatea* and *Manta*, however, muscle fibers themselves are inserted. Lack of a tendon between the depressor rostri muscle and its insertion point is considered to be the derived character state (character 84).

Suborbitalis (SB) : In most myliobatidoids and in all out-group taxa, the insertion of the suborbitalis on the mandibular cartilage is covered by the adductor mandibulae lateralis 1. In *Hexatrygon*, however, such coverage is incomplete. Because the difference is very slight, and tends to be subjective, the character is not suitable for phylogenetic analyses.

Intermandibularis posterior (IMP) : In most myliobatidoids and in most out-group taxa, a well developed intermandibularis posterior muscle is present. In *Hexatrygon*, and in the out-group genus *Torpedo* (see Chapter V-2), however, the muscle is absent. Absence of the intermandibularis posterior muscle is considered to be the derived character state (character 38).

In *Myliobatis*, *Aetomylaeus*, *Aetobatus*, *Rhinoptera*, *Mobula* and *Manta*, both sides of the intermandibularis posterior (IMP) are connected directly under the genio-coracoideus. In other myliobatidoids (except *Hexatrygon*) and in all out-group taxa (except *Torpedo*), the muscles are not connected directly, instead running over the genio-coracoideus. Direct connection of both sides of the intermandibularis posterior under the genio-coracoideus, is considered to be the derived character state (character 89).

Coraco-hyoideus (CH) : In *Myliobatis*, *Aetomylaeus*, *Aetobatus*, *Rhinoptera*,

*Mobula* and *Manta*, both sides of the coraco-hyoideus are connected directly in the mid line. In the other myliobatidoids and in most out-group taxa, this condition was not observed. Direct connection of both sides of the coraco-hyoideus muscle is considered to be the derived character state (character 90).

Number of ventral constrictors (VC): For the reasons advanced in the above discussion of dorsal constrictors, the number of ventral constrictors is considered to be phylogenetically linked with character 68. The number of ventral constrictors is not used in the phylogenetic analyses, so as to avoid character weighting.

## 2) Other muscles

*Description.* The pectoral fin muscles are made up of both dorsal and ventral elements. Essentially each muscle comprises two layers, and originates from the lateral surfaces of the propterygium, scapulocoracoid and metapterygium. Each muscle fiber runs laterally along the radials and is inserted onto the dorsal or ventral surfaces of the radials near the pectoral fin margin. Such a muscle arrangement exists in all myliobatidoids and out-group taxa.

The muscles of the cephalic lobe (or cephalic fin) are derived from anterior sections of the pectoral fin muscles. In *Aetomylaeus* and *Aetobatus*, pectoral muscles are absent from beside the head. Because the division of pectoral fin and cephalic lobe is less distinct, special muscle development has not occurred in the lobe. In *Rhinoptera* (Fig. 55), *Mobula* and *Manta*, the division of pectoral fin and cephalic fin is more distinct, and a discrete cephalic fin can be identified.

The pelvic fin muscles generally comprise adductor muscle, ventral radial muscle, extrinsic dorsal radial muscle and intrinsic dorsal radial muscle. Those muscles are generally alike in both the myliobatidoids and out-groups examined. In males, the posteromedial sections of the pelvic fin muscles are modified into the clasper muscles (see Chapter VI-3).

### *Discussion.*

Cephalic lobe or cephalic fin muscles: As discussed above, muscles associated with the cephalic lobe or cephalic fin are present in some myliobatidoids. Because

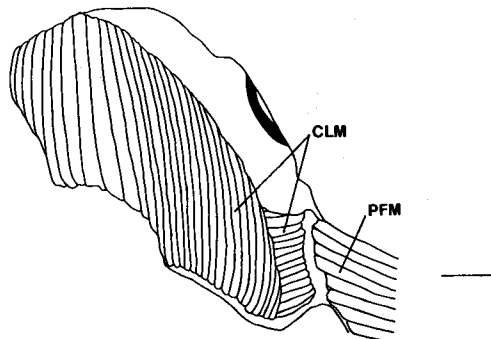

Fig. 55. Ventral view of the cephalic lobe muscles of *Rhinoptera bonasus*. CLM, cephalic lobe muscle; PFM, pectoral fin muscle. Scale indicates 10 mm.

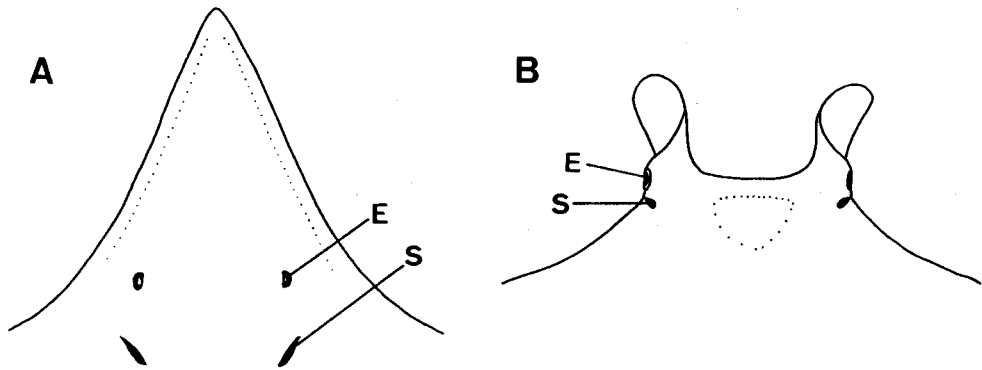

Fig. 56. Dorsal view of the head region in two myliobatoids. A, *Hezattygon longirostra*; B, *Manta birostris*. E, eye; S, spiracle.

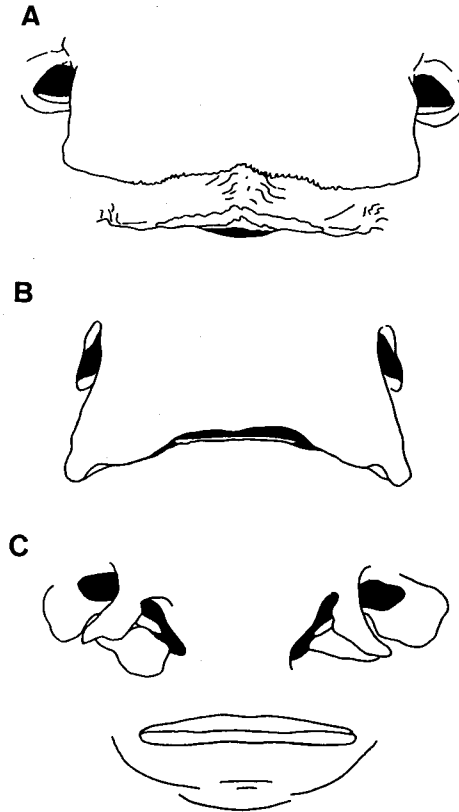

Fig. 57. The mouth and nostrils in three rajiformes. A, *Urotrygon daviesi*; B, *Myliobatis tobijei*; C, *Rhinobatos hynnicephalus*.

these muscles are clearly related to the skeletal development of cephalic lobe or fin (characters 96 and 103), muscle absence or presence is considered to have equal phylogenetic significance with characters 96 and 103. Hence they are excluded from consideration in phylogenetic analyses so as to avoid character weighting.

### 3. Other body parts

*Description.* In most myliobatidoids and in all out-group taxa, the eye and spiracle are located dorsally on the head (Fig. 56A). In *Myliobatis*, *Aetomylaeus*,

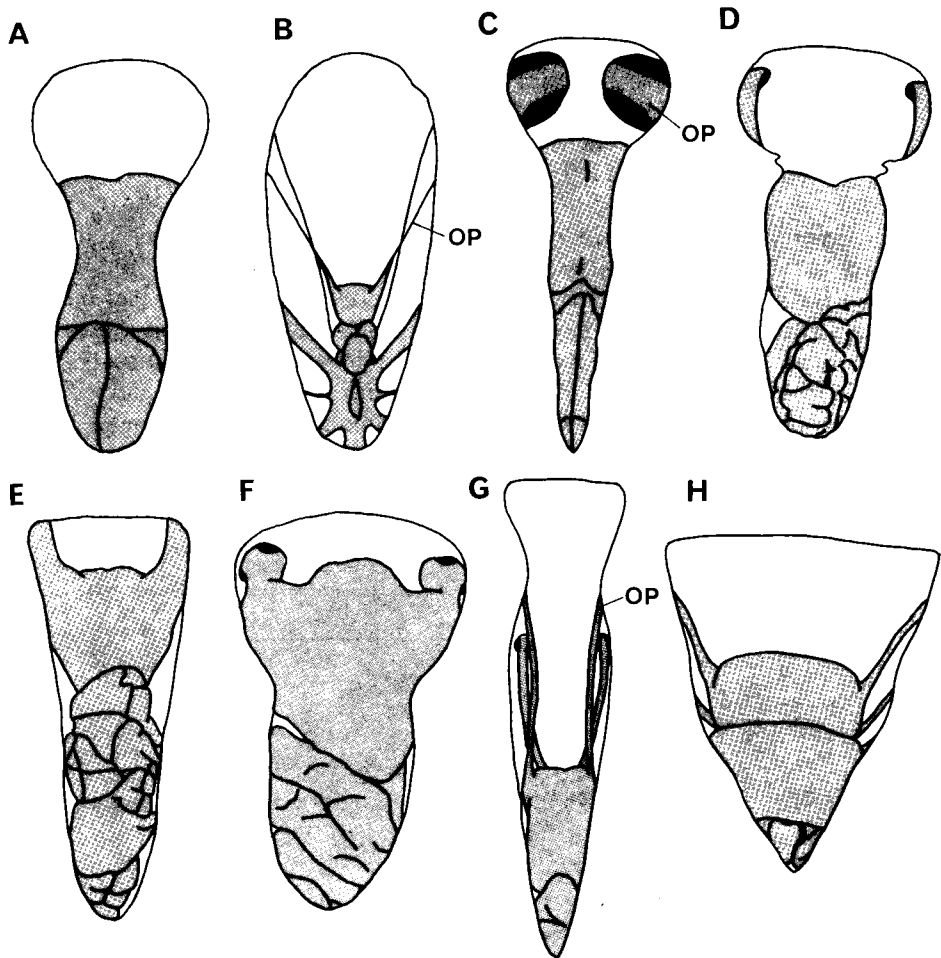

Fig. 58. The fontanelle and brain in eight myliobatidoids. A, *Urotrygon daviesi*; B, *Hexatrygon longirostra*; C, *Urolophus expansus*; D, *Potamotrygon motoro*; E, *Dasyatis pastinaca*; F, *Himantura imbricata*; G, *Rhinoptera javanica*; H, *Mobula japanica*. B and E are redrawn from Heemstra and Smith (1980). OP, olfactory peduncle.

*Aetobatus*, *Rhinoptera*, *Mobula* and *Manta* (Fig. 56B), however, they are located on the lateral surface of the head. In *Hexatrygon* (Fig. 56A) and the out-group pristoids, the spiracle is located well behind the eye, but in other myliobatidoids (Fig. 56B), and all of the out-group taxa, it is located closely to the eye.

In all myliobatidoids and in the out-group genus, *Trygonorhina*, both nostrils are completely united and nasal valves are fused to form a nasal curtain. Although the curtain reaches to the mouth in all myliobatidoids (Fig. 57B), it fails to do so in *Urotrygon daviesi* (Fig. 57A) and *Hexatrygon longirostra*. On the other hand, neither the nostrils are united, nor the nasal valves fused in most out-group taxa (Fig. 56C).

The brain is usually larger and more complicated (cerebellum convoluted) in myliobatidoids, compared with their out-groups (Fig. 58A, C-F, H), although *Hexatrygon* (Fig. 58B) and *Rhinoptera* (Fig. 58G), have a small brain with a smooth cerebellum. Table 5 shows the brain length of each species as a percentage of the fontanelle length. In *Hexatrygon* (Fig. 58B), *Rhinoptera* (Fig. 58G) and *Manta* (Fig. 58H), the olfactory peduncle (OP) is long and slender, whereas in *Urolophus* (Fig. 58C), *Potamotrygon* (Fig. 58D), *Dasyatis* (Fig. 58E) and *Himantura* (Fig. 58F), it is usually short and heavy.

The myliobatidoid clasper is relatively short and stout in comparison to that of out-group taxa. It is cylindrical and somewhat depressed (Fig. 59), with the hypopyle (HPP) lying on the dorsal midline. In *Dasyatis kuhlii*, *D. pastinaca* and *D. violacea* (Fig. 59A), a small flap (SF) is present at the proximal end base of the hypopyle base. It was absent from the other myliobatidoids examined (Fig. 59B, C). In *Dasyatis acutirostra*, *D. akajei*, *D. izuensis*, *D. violacea* (Fig. 59A), *D. zugei* and *Manta birostris* (Fig. 59C), sac 2 (sensu Lamarca, 1964) was not found. In the other myliobatidoids examined, however, sac 2 was present on the medial surface of

Table 5. Brain length in % of fontanelle length

Species	
<i>Urotrygon daviesi</i>	66
<i>Urolophus concentricus</i>	72
<i>U. expansus</i>	75
<i>Urotrygon asterias</i>	69
<i>Potamotrygon motoro</i>	66
<i>P. magdalenae</i>	66
<i>Dasyatis guttata</i>	91
<i>Himantura imbricata</i>	88
<i>Gymnura marmorata</i>	77
<i>Myliobatis californica</i>	77
<i>M. goodei</i>	66
<i>Rhinoptera javanica</i>	40
<i>Mobula japanica</i>	59

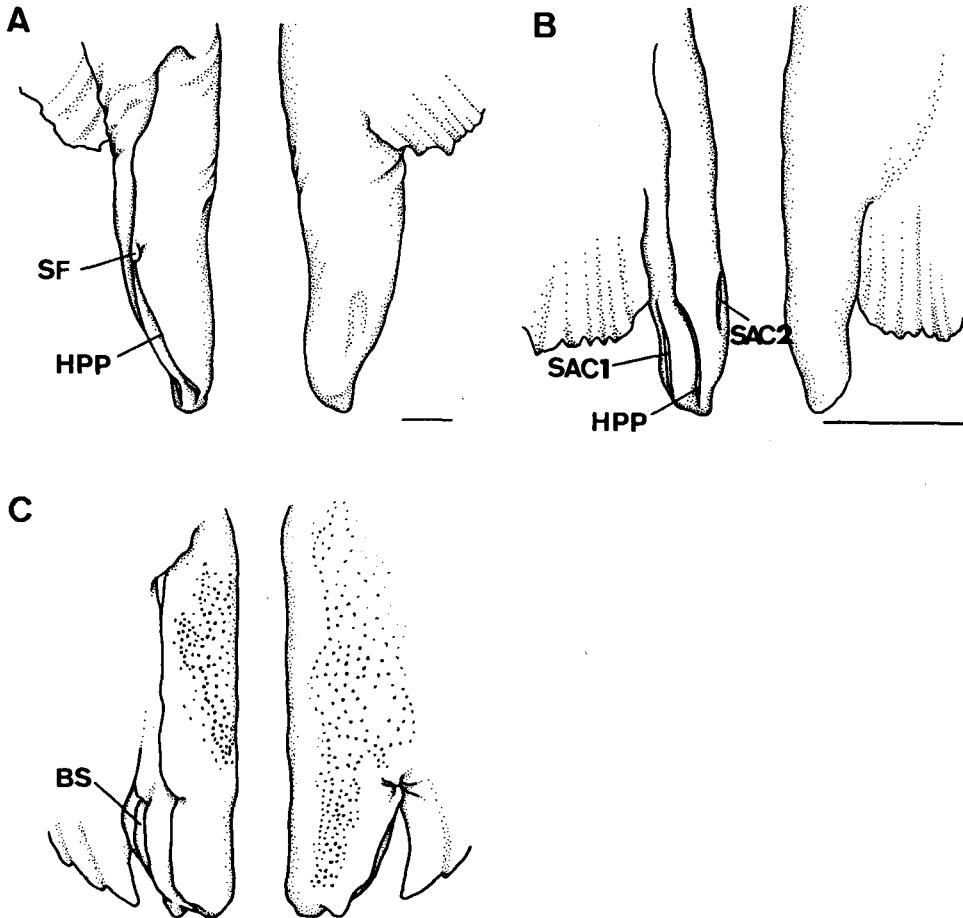

Fig. 59. Dorsal (left) and ventral (right) views of the clasper in three myliobatidoids. A, *Dasyatis violacea*; B, *Gymnura micrura*; C, *Manta birostris*. BS, bump-like swelling; HPP, hypopyle; SF, small flap. Scales indicate 10 mm.

the clasper (Fig. 59B). In *Manta birostris* (Fig. 59C), a bump-like swelling (BS) was found on the outer margin of sac 1 (sensu Lamarca, 1964) but was absent from the other myliobatidoids examined (Fig. 59A, B).

The clasper skeleton is a continuation of the pelvic fin metapterygium and consists of a series of cartilagenous structures (Fig. 60). The most proximal element(s), here termed "connecting piece (CP)" links the distal end of the metapterygium to the appendix stem. Usually two connecting pieces were found in the myliobatidoid specimens examined (Fig. 60A), but one only was evident in *Dasyatis kuhlii* (Fig. 60B) and *D. pastinaca*. The appendix stem (AS) is an axial element of the clasper and whereas its distal tip projects in both *Dasyatis kuhlii* (Fig. 60B) and *D. pastinaca*, it fails to do so in other myliobatidoids (Fig. 60A). The dorsal and

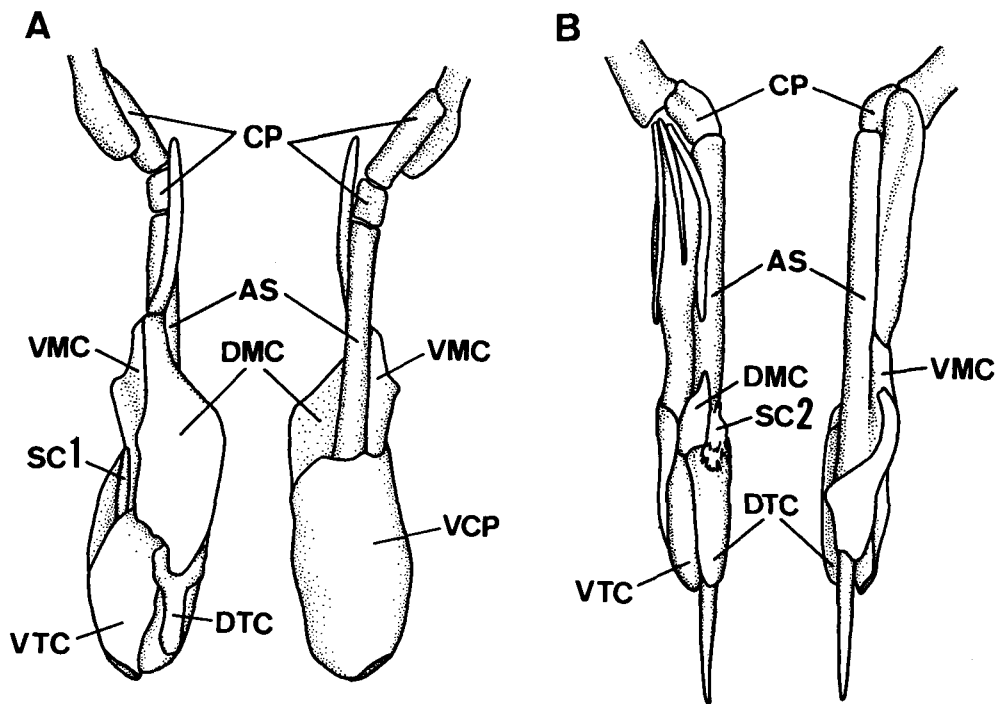

Fig. 60. Dorsal (left) and ventral (right) views of the clasper skeletons in two myliobatidoids. A, *Urolophus aurantiacus*; B, *Dasyatis kuhlii*. AS, appendix stem; CP, connecting piece; DMC, dorsal marginal cartilage; DTC, dorsal terminal cartilage; SC-1, small cartilage 1; SC-2, small cartilage 2; VCP, ventral covering piece; VMC, ventrolateral marginal cartilage; VTC, ventral terminal cartilage. Scales indicate 10 mm.

ventrolateral marginal cartilages (DMC and VMC) are plate-like and attached to the appendix stem, where they support the clasper. Distally the clasper comprises three elements: the shield-like ventral covering piece (VCP), which covers the ventral surface of the clasper; and the dorsal and ventral terminal cartilages (DTC and VTC), which support and dorsal surface of the clasper tip. The dorsal terminal cartilage, which forms the wall of the hypopyle, is usually plate-like in myliobatidoids (Fig. 60B), but bar-bike in *Urolophus* (Fig. 60A) and *Urotrygon*. The ventral terminal cartilage constitutes the bulk of the rhipidion. In *Urolophus aurantiacus* (Fig. 60A), *U. expansus*, *Gymnura micrura* and *Aetoplatea zonura*, a bar-like "small cartilage 1" (SC-1) is attached to the dorsal surface of the ventral covering piece. In *Dasyatis kuhlii* (Fig. 60B), *D. pastinaca* and *Manta birostris*, "small cartilage 2" (SC-2) is present between the appendix stem and the dorsal terminal cartilage, where it supports the margin of the sac 2.

The clasper muscles are comprised of the compressor muscle (CM), dilatator muscle (DM), external flexor muscle (EF) and outer lip muscle (OLP). In most myliobatidoids, the external flexor muscle originates from the central part of the

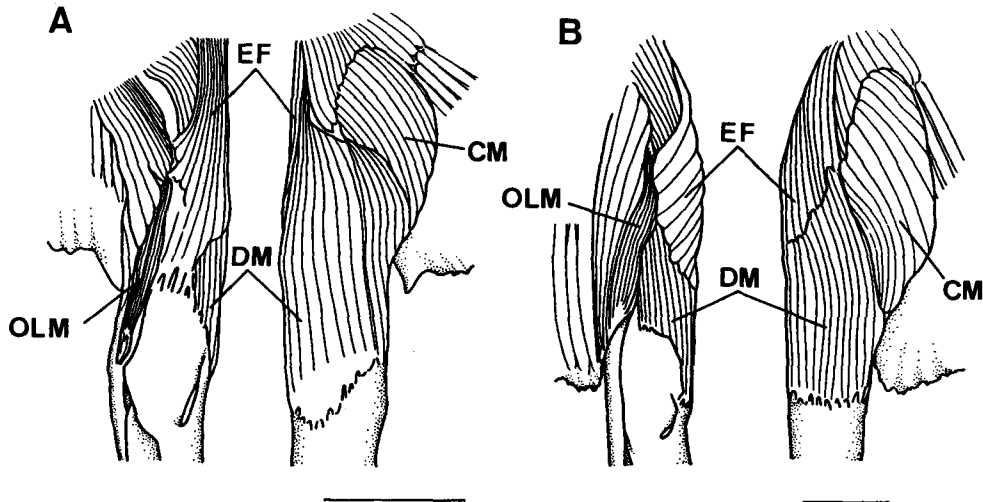

Fig. 61. Dorsal (left) and ventral (right) views of the clasper muscles in two myliobatidoids. A, *Potamotrygon yepezi*; B, *Myliobatis goodiei*. CM, compressor muscle; DM, dilatator muscle; EF, external flexor; OLM, outer lip muscle. Scales indicate 10 mm.

puboischiadic bar and is inserted onto a membrane covering the dilatator muscle (Fig. 61B). In *Potamotrygon yepezi* (Fig. 61A), however, the muscle is inserted onto the dorsal marginal cartilage.

All of the myliobatidoids examined had a tightly wound intestinal, spiral valve (Fig. 62). The number of intestinal valve turns varied from 10 (*Urolophus maculatus*) to 25-26 (*Dasyatis centroura* and *D. matsubarae* (Table 6)).

A reduced rectal gland (RG) was noted in *Potamotrygon* (Fig. 62B), which lacks urea concentrating ability. Similar reduction was not evident in other myliobatidoids (Fig. 62A, C) or in out-group taxa (Fig. 62D).

*Discussion.* The significance of the above character differences are discussed as follows, except that clasper differences are not considered for phylogenetic analyses, because adult males were unavailable for several myliobatidoid genera and species.

*Location of eye and spiracle:* In *Myliobatis*, *Aetomylaeus*, *Aetobatus*, *Rhinoptera*, *Mobula* and *Manta*, the eye and spiracle are located on the lateral surface of the head. In other myliobatidoids and in all out-group taxa, the eye and spiracle are located dorsally. A laterally positioned eye and spiracle are considered to be the derived character state (character 91).

*Relative position between eye and spiracle:* In *Hexatrygon* and the pristoids, the spiracle is located well behind the eye, but in other myliobatidoids and all of the out-group taxa, it is located closely to the eye. A spiracle well behind the eye is considered to be the derived character state (character 18).

*Development nasal curtain:* In *Urotrygon daviesi*, *Hexatrygon longirostra* and most out-group taxa, the nasal curtain is incompletely united, and fails to reach the mouth. In all other myliobatidoids and the *Trygonorhina*, the curtain reaches to

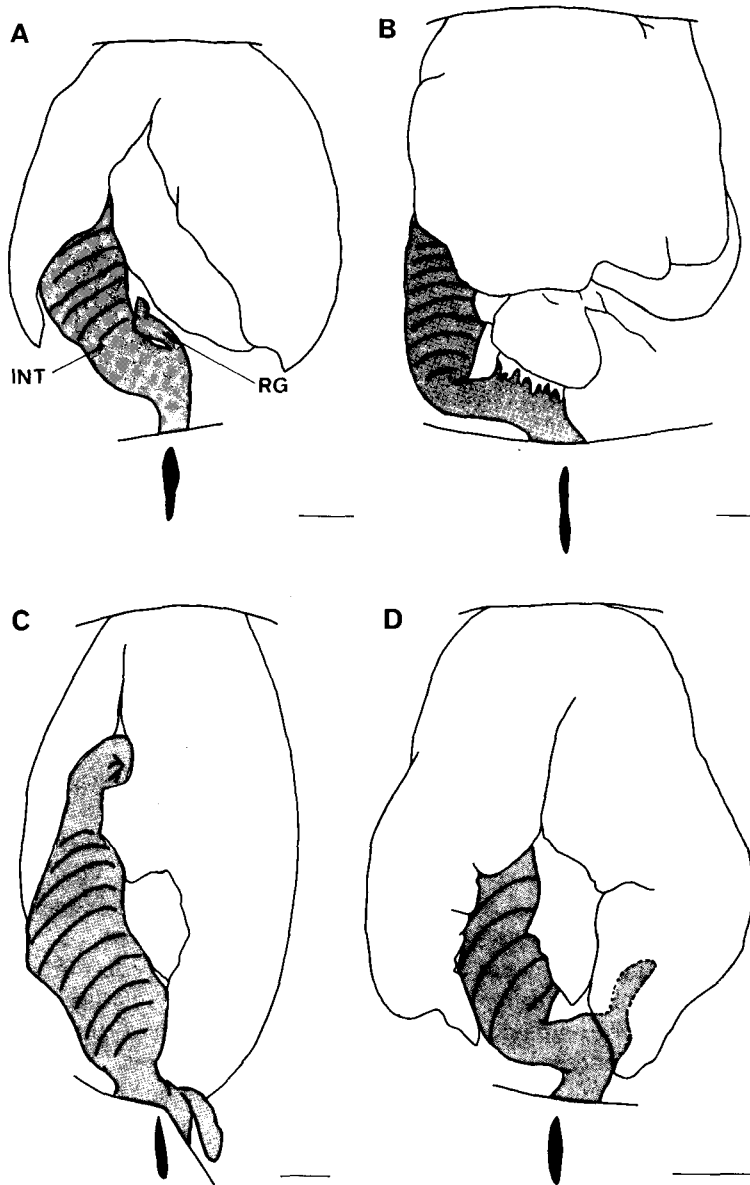

Fig. 62. Ventral view of the intestine and rectal gland in four rajiformes. A, *Urolophus maculatus*; B, *Potamotrygon magdalenae*; C, *Aetomylaeus nichofii*; D, *Narke japonica*. INT, intestine; RG, rectal gland. Scales indicate 10 mm.

Table 6. Number of intestinal valve turns.

Species	
<i>Urotrygon daviesi</i>	14
<i>Urolophus concentricus</i>	13
<i>U. halleri</i>	14
<i>U. maculatus</i>	10
<i>Urotrygon asterias</i>	11
<i>Potamotrygon castexi</i>	15
<i>P. hystrix</i>	12
<i>P. motoro</i>	12
<i>P. magdalenae</i>	12
<i>Taeniura lymna</i>	18
<i>Dasyatis acutirostra</i>	22-24
<i>D. akajei</i>	17-22
<i>D. bennetti</i>	22
<i>D. brevis</i>	22
<i>D. centroura</i>	26
<i>D. guttata</i>	21
<i>D. izuensis</i>	18-20
<i>D. kuhlii</i>	14-15
<i>D. margaritella</i>	13
<i>D. matsubarai</i>	25-26
<i>D. sabina</i>	20
<i>D. say</i>	20
<i>D. sephen</i>	20
<i>D. violacea</i>	18-21
<i>D. zugei</i>	16-18
<i>Himantura bleekeri</i>	16
<i>Gymnura altavela</i>	13
<i>G. poecilura</i>	13
<i>Myliobatis aquila</i>	22
<i>Aetomylaeus nichofii</i>	20

the mouth. Completely united and extended nasal curtain, reaching the mouth, is considered to be the derived character state (character 49).

Brain size: As shown in Table 5, the length of the brain relative to the fontanelle varies. Heemstra and Smith (1980) considered the following state to be a myliobatidoid synapomorphy: brain large, with a highly convoluted cerebellum divided into three or more asymmetric lobes. In *Hexatrygon* and *Rhinoptera*, however, the brain is small and much less convoluted, evidence against a myliobatidoid synapomorphy. More particularly, brain size and complexity shows

continuous variation in the suborder, making the character unsuitable for phylogenetic analyses.

Length of olfactory peduncle: The olfactory peduncle varies from long and slender in *Hexatrygon*, *Rhinoptera* and *Manta*, to short and heavy in *Dasyatis* and *Himantura*. Intermediate states were observed in *Urolophus*, *Urotorygon*, *Potamotrygon*, *Gymnura* and *Myliobatis*. Because it is difficult to distinguish between states objectively, the character is unsuitable for phylogenetic analyses.

Number of intestinal valve turns: Because the number of intestinal valve turns varies continuously in myliobatidoids, it is difficult to distinguish between states. Therefore the character is considered unsuitable for phylogenetic analyses.

Developmental degree of rectal gland: In most myliobatidoids and in all out-group taxa, the rectal gland is more or less developed. In *Potamotrygon*, however, it is remarkably reduced. A reduced rectal gland is considered to be the derived character state (character 78).

## VII. Myliobatidoid phylogeny

### 1. Monophyly of the Myliobatidoidei

In all phylogenetic analyses, a basic premise is that the group analyzed is, indeed, monophyletic (Wiley, 1981; 141). Accordingly, myliobatidoid monophyly is here discussed in detail. Seret (1986) recently summarized the many taxonomic (phylogenetic) studies on chondrichthians, since the work of Müller and Henle (1984). Originally, myliobatidoids were not considered by many workers, to be a natural group. Müller and Henle (1841), Günther (1870), Garman (1931), Berg (1940) and Norman (1966) divided myliobatidoids into two or more groups, placing them with other rajiform groups. On the other hand, myliobatidoids were unified by Jordan (1932), White (1937), Bertin (1939), Bigelow and Schroeder (1953), Arambourg and Gertin (1958), and Compagno (1973, 1977). Recently, Heemstra and Smith (1980) established a new suborder, Hexatrygonoidei, proposing a sister-group relationship with the Myliobatidoidei. Nelson (1984), however, relegated the Hexatrygonoidei to a family within the Myliobatidoidei.

The following character states were proposed as synapomorphies of the Hexatrygonoidei by Heemstra and Smith (1980): 1. Six gill arches and gill openings; 2. Snout elongate, thin (depressed), translucent, filled with a clear gelatinous substance and provided with numerous prominent ampullae of Lorenzini; 3. No supraorbital crests on cranium; 4. Spiracles well back from eyes, closed dorsally by a flap extending from anteromedial rim of spiracle to form an oblique slit at posterolateral edge of orifice. As discussed in chapter VI, however, character states 2 and 4 exist in some other myliobatidoid species. Furthermore, character state 3 is not observed in *Hexatrygon longirostra*, which clearly belongs to the same group. Accordingly, these three character states cannot be synapomorphies of Hexatrygonoids. On the other hand, Heemstra and Smith (1980) proposed the following myliobatidoid synapomorphies: 1. Brain large, with a highly convoluted cerebellum, divided into three or more asymmetric lobes; 2. Nostrils close together, with the anterior nasal flaps connected to form a broad nasal curtain overlapping the upper jaw; 3. Nasoral grooves present, usually well developed. These character

states, however, are not shared by all myliobatidoids (see Chapter VI), and cannot therefore be myliobatidoid synapomorphies.

The suborder Myliobatidoidei (including *Hexatrygon* species) is here regarded as a monophyletic group (Fig. 4), which shares the following six apomorphic states: Ventral pseudohyoid bar proximally fused with 1st ceratobranchial cartilage (character 61); Levator rostri muscle absent (62); Socket and condyle articulation between synarcual and scapular cartilage (63); Loss of ribs (64); Postorbital process very wide and flat (65); Second synarcual present (66).

## 2. Character states and distribution

As discussed earlier 45 characters were selected and their polarity determined, for the construction of a myliobatidoid phylogeny. In this section, each character state and its distribution among myliobatidoids is summarized. In the following list, the primitive state is given first, followed by the derived state. Character numbers correspond to those used earlier for the character analysis, and in the Figs. 4, 63, 65-72.

17. Preorbital process present; absent.
18. Eyes and spiracles close together; wide apart.
37. Nasal capsule expanded laterally; ventrolaterally.
38. Intermandibularis posterior muscle present; absent.
46. Last epibranchial cartilage, and 4th (5th in *Hexatrygon*) and 5th (6th) pharyngobranchial cartilages fused; not fused.
49. Nasal curtain incompletely united (or absent), not reaching mouth; completely united, reaching mouth.
56. Caudal fin present; reduced to tail folds or absent.
67. Postorbital process with two, well separated projections; with a single projection.
68. Number of branchial arches five; six.
69. All pharyngobranchial cartilages not fused; fused.
70. Radials on rostral extensions of propterygia present; absent.
71. Ligament between mandibular and hyomandibular cartilages absent; present.
72. Postdorsal fenestra present; absent.
73. Hyomandibular accessory cartilage 2 absent; present.
74. Proximal parts of 1st and 2nd ceratobranchial cartilages not fused; fused.
75. Angular cartilage between mandibular and hyomandibular cartilages absent; present.
76. Proximal parts of first 4 ceratobranchial cartilages not fused; fused.
77. Bar-like prepelvic process absent; present.
78. Rectal gland developed; reduced.
79. Caudal fin or tail folds reached to tail tip present; absent or if present not reached to tail tip.
80. Caudal fin or tail folds present; absent.
81. Postorbital process posteriorly located; anteriorly located.
82. Articulation of neighbouring pectoral radials absent; present.
83. Precranial muscle absent; present.



84. Depressor rostri converted into tendon ; not converted into tendon.
85. Anterior foramen for preorbital canal dorsally located ; anteriorly located.
86. Wing-like process on mandibular cartilage absent ; present.
87. Condyles for last epibranchial and ceratobranchial cartilages close ; well separated.
88. Triangular prepelvic process absent ; present.
89. Intermandibularis posterior muscles not fused medially ; fused medially.
90. Coraco-hyoideus muscles not fused medially ; fused medially.
91. Eyes and spiracles located dorsally ; laterally.
92. Mandibular cartilage thin, plate-like ; thick and strong.
93. Flat and pavement-like teeth absent ; present.
94. Hyomandibular accessory cartilage 1 absent ; present.
95. Hypo- and basi-hyoid cartilages present ; absent.
96. Cephalic lobe absent ; present.
97. Both sides of jaws separate ; fused medially.
98. Lateral margin of postorbital process not protruding ; bar-like and ventrally protruding.
99. Anterior process of neurocranium absent ; present.
100. Origin of dorsal longitudinal bundles posterior to postorbital process ; anterior to postorbital process.
101. Interorbital width narrower than neurocranium length ; wider than neurocranium length.
102. Scapulocoracoid articulated with propterygium ; prolonged and fused with propterygium.
103. Cephalic fin absent ; present.
104. Upper jaw teeth present ; absent.

Distributions of the character states above are summarized in Fig. 63.

### 3. Interrelationships of the Myliobatidoidei

On the basis of the characters summarized above, a cladistic analysis of 57 myliobatidoid species is made, based on the phylogenetic principles of Hennig (1966), and on parsimony (Nelson, 1970) (Fig. 64).

The common stem of the Myliobatidoidei divides trichotomously at the first branching point (A) (Fig. 65). The first stem includes only *Urotrygon daviesi*, and is characterized by two autapomorphies ; the last epibranchial cartilage not fused with the fourth and fifth pharyngobranchial cartilages (character 46), and fused postorbital processes (character 68). The second stem includes only *Hexatrygon longirostra*, which is characterized by five autapomorphies ; six gill arches (character 68), all pharyngobranchial cartilages proximally fused (character 69), rostral extensions of the propterygia present (character 70), intermandibularis posterior muscle absent (character 38), and eyes and spiracles wide apart (character 18). The third stem, which includes all of the remaining myliobatidoid species examined, is

---

Fig. 63. Distributions of 45 character states in 57 myliobatidoids. Plesiomorphic state shown by open circle, apomorphic state by solid circle. For each character state, see text.

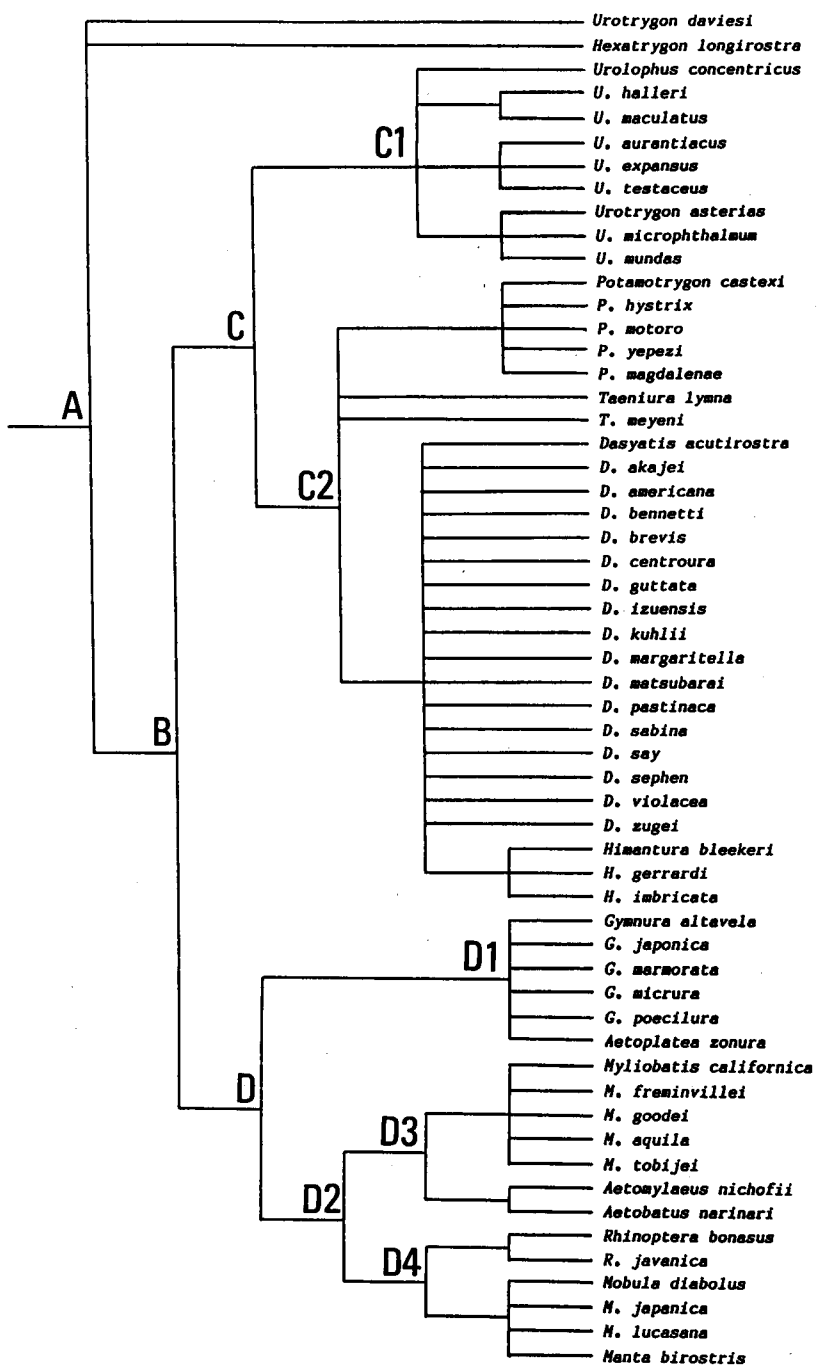

Fig. 64. Cladogram showing relationships of 57 myliobatidoid species. For explanation, see text.

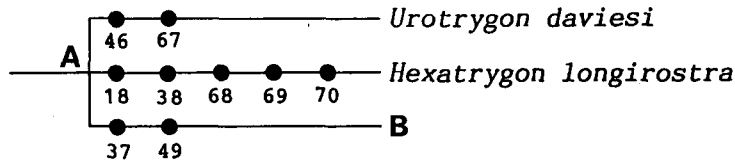

Fig. 65. Branching pattern at point A. Solid circle indicates an apomorphic state. For each character state, see text.

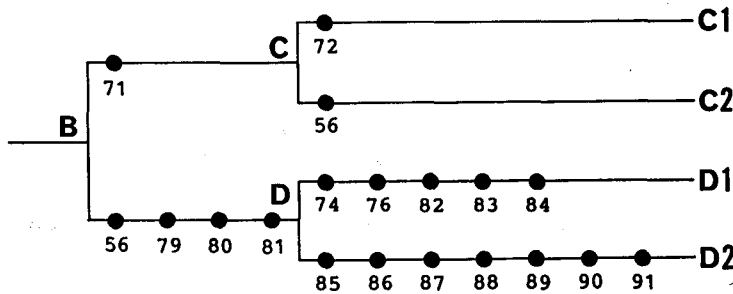

Fig. 66. Branching pattern at points B, C and D. Solid circle indicates an apomorphic state. For each character state, see text.

characterised by two autapomorphies; ventrolaterally expanded nasal capsule (character 37), and nasal curtain completely united and reaching mouth (character 49).

At the dichotomous branching point B (Fig. 66), the substem including *Urolophus*, *Urotrygon*, *Potamotrygon*, *Taeniura*, *Dasyatis* and *Himantura*, is characterized by a single synapomorphy; presence of a ligament between the mandibular and hyomandibular cartilages (character 71).

At point C, branching is again dichotomous. C1 species are characterized by the absence of a postdorsal fenestra (character 72). This group includes species of *Urolophus* and *Urotrygon* (except *Urotrygon daviesi*).

C1 species can be further subdivided (Fig. 67). The first subgroup, *Urolophus*

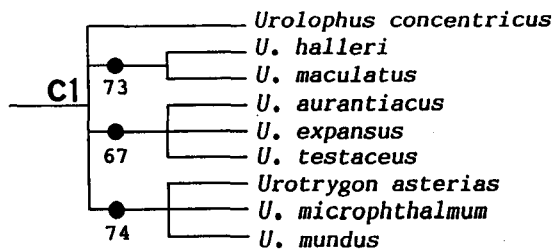

Fig. 67. Branching pattern at point C1. Solid circle indicates an apomorphic state. For each character state, see text.

*concentricus*, has no further apomorphic characters. The second subgroup, which contains *Urolophus halleri* and *U. maculatus*, is characterized by the presence of the hyomandibular accessory cartilage 2 (character 73). The third subgroup, including *Urolophus aurantiacus*, *U. expansus* and *U. testaceus*, has the postorbital processes fused, forming a single process (character 67), and the fourth subgroup of *Urotrygon asterias*, *U. microphthalmum* and *U. mundus* has the proximal parts of 1st and 2nd ceratobranchial cartilages fused (character 74). Interrelationships within the third and fourth subgroups are not yet fully resolved.

The second group of the branching point C (Fig. 66) has the caudal fin either reduced to tail folds or absent (character 56). This group includes *Potamotrygon*, *Taeniura*, *Dasyatis*, and *Himantura*, and is divided into four subgroups (C2) (Fig. 68). The first subgroup, *Potamotrygon*, is characterized by three autapomorphies; presence of an angular cartilage between the mandibular and hyomandibular cartilages (character 75), presence of a bar-like prepelvic process (character 77), and reduction of the rectal gland (character 78); and two synapomorphies; fusion of the proximal parts of the 1st and 2nd ceratobranchial cartilages (character 74), and fusion of the proximal parts of all the ceratobranchial cartilages (character 76).

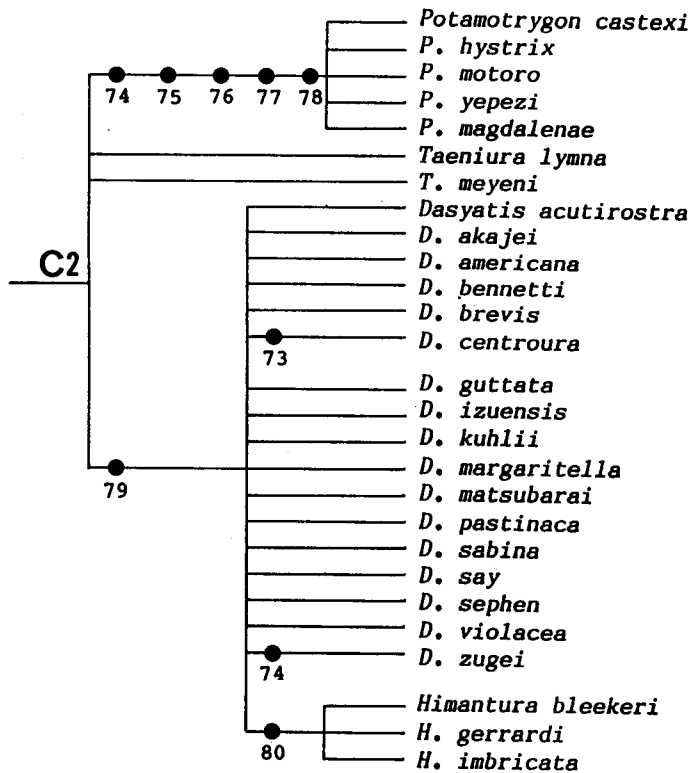

Fig. 68. Branching pattern at point C2. Solid circle indicates an apomorphic state. For each character state, see text.

The second and third subgroups, *Taeniura lymna* and *T. meyeri*, respectively, branch independently at C2, with no additional apomorphies. The fourth subgroup includes all of the species of *Dasyatis* and *Himantura*, and is characterized by the reduction of the caudal fin to either tail folds, not reaching the tail tip, or complete absence (character 79). In this subgroup, the relationships *Dasyatis* and *Himantura*, and the interrelationships of *Dasyatis* species are not well resolved. *Himantura* species themselves are characterized by the absence of a caudal fin or tail folds (character 80).

The remaining substem at point B (Fig. 66) is characterized by an autapomorphy; presence of an anteriorly located postorbital process (character 81); and three synapomorphies; caudal fin absent or reduced to tail folds (character 56), caudal fin absent or reduced to tail folds, not reaching tail tip (character 79), absence of caudal fin or tail folds (character 80). This substem divides dichotomously at point D (Fig. 66). The first group includes *Gymnura* and *Aetoplatea*, and is characterized by one autapomorphy; presence of a precranial muscle (character 83); and four synapomorphies; fusion of the proximal part of the first and second ceratobranchial cartilages (character 74); fusion of the proximal part of all of the ceratobranchial cartilages (character 76); articulation of the pectoral radials (character 82); depressor rostri muscle not converted into a tendon (character 84). The interrelationships of this group can not yet be resolved (Fig. 69).

The second group branching at point D (Fig. 66) is characterized by seven autapomorphies; preorbital canal anterior foramen located anteriorly (character 85); presence of a wing-like process on the mandibular cartilage (character 86); condyles for the last epibranchial and ceratobranchial cartilages wide apart (character 87); a triangular prepelvic process (character 88); intermandibularis posterior muscles fused medially (character 89); both coraco-hyoideus muscles fused medially (character 90); and eyes and spiracles located laterally (character 91). At point D2, the group divides into two subgroups (Fig. 70). The first, including *Myliobatis*, *Aetomylaeus*, *Aetobatus*, is characterized by four synapomorphies; pres-

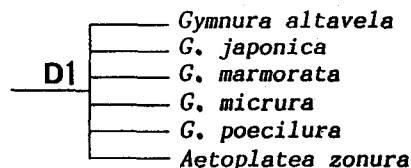

Fig. 69. Branching pattern at point D1.

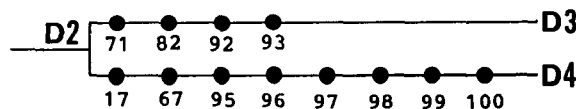

Fig. 70. Branching pattern at point D2. Solid circle indicates an apomorphic state. For each character state, see text.

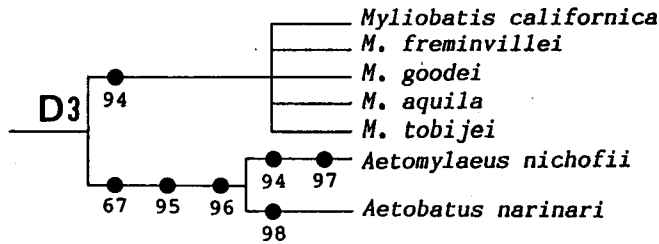

Fig. 71. Branching pattern at point D3. Solid circle indicates an apomorphic state. For each character state, see text.

ence of a ligament between the mandibular and hyomandibular cartilages (character 71); mandibular cartilage thick and strong (character 92); flat, pavement-like teeth (character 93); and articulation of the pectoral radials (character 82). In this subgroup (Fig. 71), all of the species of *Myliobatis* are characterized by the presence of the hyomandibular accessory cartilage 1 (character 94). The remaining two genera, *Aetomylaeus* and *Aetobatus*, are characterized by three synapomorphies; postorbital processes fused (character 67); hypo- and basi-hyoid cartilages absent (character 95); and cephalic lobe present (character 96).

The second subgroup at point D2 (Fig. 70) includes *Rhinoptera*, *Mobula* and *Manta*, and is characterized by three autapomorphies; presence of an anterior neurocranial process (character 99); preorbital process absent (character 17); and origin of dorsal longitudinal bundles being anterior to postorbital process (character 100); and by five synapomorphies; postorbital processes fused (character 67); lateral margin of postorbital process bar-like and protruding ventrally (character 98); both sides of jaws fused medially (character 97); hypo- and basi-hyoid cartilages absent (character 95); and cephalic lobe present (character 96). In this subgroup (Fig. 72), two *Rhinoptera* species have three synapomorphies; a ligament between the mandibular and hyomandibular cartilages (character 71); mandibular cartilage thick and strong (character 92); and flat, pavement-like teeth (character 93). Species of *Mobula* and *Manta* (D4 branch) have three autapomorphies; interorbital width wider than neurocranium length (character 101); scapulocoracoid elongate and fused with propterygium (character 102); and cephalic fin present (character 103). The interrelationships of *Mobula* and *Manta* are not yet fully

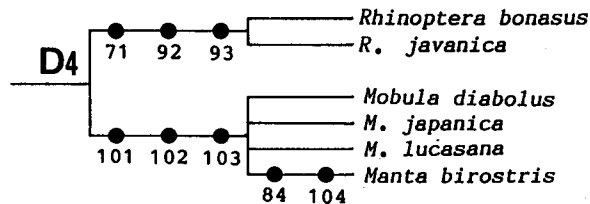

Fig. 72. Branching pattern at point D4. Solid circle indicates an apomorphic state. For each character state, see text.

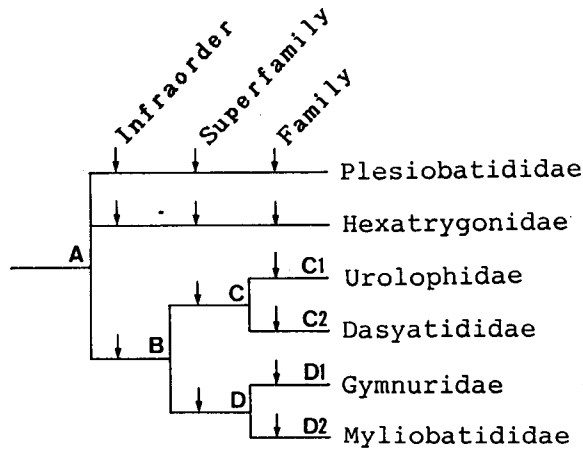

Fig. 73. Phylogenetic classification. Ranking of higher taxonomic levels.

resolved. *Manta* is characterized by one autapomorphy; absence of upper jaw teeth (character 104); and one synapomorphy; depressor rostri muscle not converted into a tendon (character 84).

#### 4. Phylogenetic classification

As mentioned in chapter IV, the same rank is given to sister groups. Because it was inappropriate for generic level ranking in this study owing to a lack of some type species for examination, and because relationships of some terminal species of each stem could not be clearly resolved, only family level ranking is discussed further.

In the proposed overall cladogram (Fig. 64), myliobatidoids are divided into three stems at the first branching point A, four substems at point B, six groups at branching points C and D, and 18 subgroups at points C1, C2, D1 and D2. Theoretically, any point can be chosen for ranking the family level. Family rank is, however, given for *Urotrygon daviesi*, *Hexatrygon longirostra*, and two groups each at branching points C and D respectively. This minimizes taxonomic changes (Fig. 73). Furthermore, in order to more closely reflect relationships in classification, infraordinal rank is given for the three stems at branching point A, and superfamily rank for *Urotrygon daviesi*, *Hexatrygon longirostra* and the two substems of the branching at point B (Fig. 73). As a result, the following three infraorders, four superfamilies and six families (including new ranks) are proposed:

- Suborder Myliobatidoidei
  - Infraorder Plesiobatidides
    - Superfamily Plesiobatidoidea
      - Plesiobatididae fam. nov.
        - Plesiobatis* gen. nov.
  - Infraorder Hexatrygones
    - Superfamily Hexatrygonoidea

- Family Hexatrygonidae
  - Hexatrygon*
- Infraorder Myliobatidides
  - Superfamily Dasyatidoidea
    - Family Urolophidae
      - Urolophus*
      - Urotrygon*
    - Family Dasyatididae
      - Potamotrygon*
      - Taeniura*
      - Dasyatis*
      - Himantura*
  - Superfamily Myliobatidoidea
    - Family Gymnuridae
      - Gymnura*
      - Aetoplatea*
    - Family Myliobatididae
      - Myliobatis*
      - Aetomylaeus*
      - Aetobatus*
      - Rhinoptera*
      - Mobula*
      - Manta*

*Plesiotrygon*, *Paratrygon*, and *Urogymnus* species were not examined in this study. All of the above genera are monotypic, and are known from relatively few specimens. Although they have been excluded from the classification proposed above, judging from published information (Garman, 1913; Rosa et al., 1987), *Plesiotrygon* and *Paratrygon* are possibly members of the Dasyatididae, forming a monophyletic group with *Potamotrygon*. The position of *Urogymnus* remains unresolved, owing to a lack of anatomical information.

A) Plesiobatididae fam. nov.

Diagnosis. Eyes and spiracles located dorsally and close to each other. Nasal capsules expanded laterally. Nasal curtain incompletely united, not reaching mouth. Caudal fin present. Postorbital processes fused with each other. Last epibranchial cartilage not fused with 4th and 5th pharyngobranchial cartilages. Five branchial arches. Fourth and 5th pharyngobranchial cartilages proximally fused. Rostral extensions of pectoral propterygia absent. Intermandibularis posterior muscle present.

*Plesiobatis* gen. nov.

Diagnosis. Same as the family.

Type species. *Urotrygon davisii* (Wallace, 1967).

Etymology. The generic name is a combination of the Greek, *plesio* (meaning "primitive") and *batis* (meaning "ray").

Remarks. The type species of this genus has long been recognized as a member of the genus *Urotrygon* by virtue of its long caudal fin. As mentioned above, however, *Urotrygon* cannot be considered monophyletic unless *U. daviesi* is excluded. *U. daviesi* forms one of the three stems at the first branching point (A) of myliobatidoid phylogeny (Fig. 65). *Plesiobatis* is clearly distinguished from *Urotrygon* by having the nasal curtain incompletely united, not reaching the mouth, and by its large size and soft disc.

#### B) Hexatrygonidae

Diagnosis. Eyes and spiracles located dorsally and well separated from each other. Nasal capsules expanded laterally. Nasal curtain incompletely united, not reaching mouth. Postorbital processes not fused. Caudal fin present. Six gill arches. Last epibranchial cartilage fused with pharyngobranchial cartilage. All pharyngobranchial cartilages fused. Rostral extensions of propterygia present. Intermandibularis posterior muscle absent.

Remarks. This family includes a single genus, *Hexatrygon*. Heemstra and Smith (1980) proposed it as a sister group of the suborder Myliobatidoidei, giving it subordinal rank (Hexatrygonoidei). The present study, however, does not uphold this.

#### C) Urolophidae

Diagnosis. Eyes and spiracles located dorsally and close to each other. Nasal capsules expanded ventrolaterally. Nasal curtain completely united and reaching mouth. Ligament present between mandibular and hyomandibular cartilages. Caudal fin present. Postdorsal fenestra absent.

Remarks. This family includes *Urolophus* and *Urotrygon* (except *U. daviesi*, which is transferred to *Plesiobatis* n. gen.).

#### D) Dasyatididae

Diagnosis. Eyes and spiracles located dorsally, and close to each other. Nasal capsules expanded ventrolaterally. Nasal curtain completely united, reaching mouth. Ligament present between mandibular and hyomandibular cartilages. Caudal fin reduced to tail folds or absent.

Remarks. This family includes *Potamotrygon*, *Taeniura*, *Dasyatis* and *Himantura*.

#### E) Gymnuridae

Diagnosis. Eyes and spiracles located dorsally, and close to each other. Nasal curtain completely united, reaching mouth. Caudal fin or tail folds absent. Precranial muscle present. Proximal parts of first 4 ceratobranchial cartilages fused. Articulation of pectoral radials present. Depressor rostri muscle not converted into tendon.

Remarks. This family includes *Gymnura* and *Aetoplatea*.

#### F) Myliobatididae

Diagnosis. Eyes and spiracles located laterally and close to each other. Nasal curtain completely united, and reaching mouth. Caudal fin or tail folds absent.

Anterior foramen for preorbital canal located anteriorly. Wing-like process present on mandibular cartilage. Condyles for 5th epibranchial and ceratobranchial cartilages well apart from each other. Triangular prepelvic process. Intermandibularis posterior muscle runs under genio-coracoideus muscle, to fuse medially with antimere. Coraco-hyoideus muscle fused medially with antimere.

Remarks. This family includes *Myliobatis*, *Aetomylaeus*, *Aetobatus*, *Rhinoptera*, *Mobula* and *Manta*.

### VIII. General discussion

The myliobatidoid phylogeny and classification presented here differs from those of former studies in several respects. *Plesiobatis daviesi*, formerly considered to be a urolophid, is given separate infraordinal rank, and *Hexatrygon* is returned to infraordinal rank. All other species considered have been included in the infraorder Myliobatidides, which is characterised by two synapomorphies (characters 37, 49). The relationships between the three infraorders could not be solved because of a lack of synapomorphies.

A reassessment of the relationships between urolophids, dasyatidids and gymnurids has been made. Formerly, urolophids and gymnurids have been included in the Dasyatidae (Garman, 1931; White, 1937; Nelson, 1984), but present study shows that the Urolophidae is a sister group of the Dasyatididae, and that the Gymnuridae is a sister group of the Myliobatididae (Fig. 73). Formerly, *Potamotrygon* was placed in a separate family (Potamotrygonidae) (Garman, 1913; White, 1937; Bigelow and Schroeder, 1953; Compagno, 1973; Nelson, 1984), and Brooks et al. (1981) suggested the possibility (based on co-evolutional methodology) that potamotrygonids had arisen from *Urolophus*-like ancestral stingrays. These hypotheses, however, are refuted by a synapomorphy (character 56) that supports a relationship of *Potamotrygon* with *Taeniura*, *Dasyatis* and *Himantura*. These four genera are now considered to form a monophyletic group (Dasyatididae). The Gymnuridae forms a monophyletic group with the Myliobatididae, but not with the Dasyatididae nor Urolophidae, characterised by four apomorphic character states (characters 56, 79-81). The Gymnuridae and Myliobatididae each have many shared derived characters.

The Myliobatididae of this study includes three formerly recognized families, Myliobatidae, Rhinopterae and Mobulidae. Formerly (Garman, 1913; Nelson, 1984), a close relationship has been proposed between *Rhinoptera* and a group including *Myliobatis*, *Aetomylaeus* and *Aetobatus*. This study, however, indicates greater closeness between *Rhinoptera*, and *Mobula* and *Manta*.

Several ecological features are in accordance with the proposed phylogeny. Both plesiobatidids and hexatrygonids are deep bottom dwellers. *Plesiobatis daviesi* has been recorded from 44-440 m (usually deeper than 200 m) (Wallace, 1967; Nakaya, 1982, 1984), and *Hexatrygon* species from 350-1,000 m (Heemstra and Smith, 1980; Chu et al., 1981; Ishihara and Kishida, 1984; Shen and Liu, 1984). On the other hand, species of the infraorder Myliobatidides are distributed in relatively shallow waters. Urolophids, dasyatidids and gymnurids are generally bottom dwellers, and myliobatidids are relatively active, mid-water swimmers.

Differences in the manner of swimming are also in keeping with the proposed cladogram. Generally the main sources of propulsion are the pectoral fins (Moss, 1984), but movements of the fins occur in one of two ways, i.e. undulation and flapping. In the plesiobatidids, hexatrygonids, urolophids and dasyatidids, propulsion is obtained through vertical sinusoidal undulations of the lateral margins of the pectoral fins, and in the gymnurids and myliobatidids, through an overall flapping motion (Moss, 1984). In relation to the flapping motion of the pectoral fins, the distal tips of the pectoral fin radials may be articulated with one another (character 82) in the gymnurids and in *Myliobatis*, *Aetomylaeus* and *Aetobatus*.

Several myliobatidoid species are freshwater inhabitants. These include *Potamotrygon* species and *Dasyatis garouaensis* (Stauch et Blanc, 1962) and *Himantura signifer* Compagno et Roberts, 1982. The two latter species are known only from freshwater habitats (Compagno and Roberts, 1982). *Dasyatis sephen* is a common stingray in marine and estuarine habitats, and *Myliobatis californica* is also a common inhabitant of shallow inshore waters and estuaries (Martin, 1982). Of the above species, those reported only from freshwater are here restricted to the Dasyatididae.

All species of *Myliobatis*, *Aetomylaeus*, *Aetobatus* and *Rhinoptera* feed on benthic invertebrates (Gudger, 1914 and Martin, 1982). Their feeding habit of using the snout to uncover molluscs, which are then crushed by their strong jaws, is reflected by the strong mandibular and palatoquadrate cartilages (character 92), pavement-like teeth (character 93), and strong adductor muscles. The manta ray (*Manta*) is a plankton feeder, which has subsequently lost its upper jaw teeth (character 104). The ligament (character 71) and angular cartilage (character 75) between the mandibular and hyomandibular cartilages (observed in urolophids, dasyatidids and some myliobatidids) seem to be utilized in mouth protrusion.

*Myliobatidoid evolution* — Some hypotheses on myliobatidoid evolution are put forward, based on the proposed phylogeny. Myliobatidoids arose from an ancestral morphotype, which shared a common ancestry with rajoids. The morphotype was possibly benthic and relatively inactive. Its rostrum, if present, was reduced as in *Urotrygon microphthalmum*, and its main source of propulsion may have been by vertical sinusoidal undulations of the pectoral fins, although it had a caudal fin. The slender tail may have been armed with a spine(s). The ancestral morphotype gave rise to three groups. Both infraorder Plesiobatidides and Hexatrygones retain many ancestral features (e.g., bottom dweller, inactive), although the latter has attained several noteworthy features; for example, six gill arches, fused pharyngo-branchial cartilages. The Myliobatidides on the other hand, occupies a shallow-water habitat. It comprises two superfamilies, the first of which, Dasyatidoidea, which retains many ancestral characters, is divided into urolophids and dasyatidids. Urolophids are shallow, bottom dwellers, which have retained the caudal fin. Dasyatidids are also shallow bottom dwellers, but have lost the caudal fin. They are the most differentiated group of myliobatidoids including about 80 species. Among them, *Potamotrygon* is the most specialized group habitat-wise, being restricted to fresh-water habitats. The superfamily Myliobatidoidea (gymnurids and myliobatidids) acquired a distinctive new swimming style, that is flapping

motions of the pectoral fins. Gymnurids have many derived characters, whilst retaining several ancestral features (benthic and non-active). Altogether, myliobatidids are the most derived group, being active swimmers with increasingly specialized teeth. *Myliobatis*, *Aetomylaeus*, *Aetobatus* and *Rhinoptera* all have plate-like teeth, and *Manta* (a plankton feeder) lacks upper jaw teeth.

### IX. Summary

This study was made with the fourfold purpose of (1) describing the skeletal and myological characters of myliobatidoids in detail, (2) clarifying the monophyly of the suborder Myliobatidoidei, (3) estimating interrelationships of the suborder, and (4) presenting a phylogenetic classification of the suborder. Examples of 57 species from 15 myliobatidoid genera and 30 species from 24 genera of other rajiformes, were used for the comparative study. Skeletal (neurocranium; visceral arches; pectoral girdle, pectoral fin and cephalic fin; pelvic girdle and pelvic fin; vertebrae, dorsal fin and caudal fin), muscular (head and body muscles; other muscles), and other (external morphology; brain; intestine; rectal gland; clasper) systems were examined. Forty-five characters were selected for a proposal of myliobatidoid phylogeny. The polarity of each character was determined according to Maddison et al. (1984), and Hennig's (1966) cladistic method was used to construct phylogenetic relationships. Conclusions are summarized below.

(1) The suborder Myliobatidoidei is considered to be a monophyletic group defined by six synapomorphies, i.e. the ventral pseudohyoid bar proximally fused with the 1st ceratobranchial cartilage, levator rostri muscle absent, socket and condyle articulation between the synarcual and scapular cartilage, loss of ribs, postorbital process wide and flat, and presence of a second synarcual.

(2) The phylogenetic relationships of the myliobatidoids were assessed and a cladogram constructed (Fig. 64).

(3) To enable the classification to reflect phylogenetic relationships, three infraorders, four superfamilies, and six families are recognized in the suborder (Fig. 73).

(4) A new family Plesiobatididae is proposed, as the only member of the infraorder Plesiobatidides. It includes a single, new genus *Plesiobatis*, which is proposed for *Urotrygon daviesi*. The family is defined by two synapomorphies; the last epibranchial cartilage not being fused with the 4th and 5th pharyngobranchial cartilages, and the postorbital processes fused.

(5) The family Hexatrygonidae is the only member of the infraorder Hexatrygones, and includes one genus *Hexatrygon*. It is defined by five synapomorphies; six gill arches; all pharyngobranchial cartilages proximally fused; rostral extensions of propterygia present; intermandibularis posterior muscle absent; and eye widely separated from spiracle.

(6) The remaining four families are included in the infraorder Myliobatidides. The infraorder is considered to be a monophyletic group, defined by two synapomorphies; a ventrolaterally expanded nasal capsule; and nasal curtain completely united and reaching mouth.

(7) The families Urolophidae and Dasyatididae are included in the super-

family Dasyatidoidea. This is a monophyletic group defined by a single synapomorphy; the presence of a ligament between the mandibular and hyomandibular cartilages.

(8) The families Gymnuridae and Myliobatidae are included in the superfamily Myliobatidoidea. This is a monophyletic group defined by four synapomorphies; absence of a caudal fin or tail folds; and anteriorly positioned postorbital process.

(9) The family Urolophidae is a monophyletic group defined by a single synapomorphy; absence of postdorsal fenestra. This family includes only the two genera examined, *Urolophus* and *Urotrygon* (except *Urotrygon daviesi*).

(10) The family Dasyatidae is a monophyletic group defined by a single synapomorphy; reduction of the caudal fin to tail folds. This family includes four examined genera *Potamotrygon*, *Taeniura*, *Dasyatis* and *Himantura* (and may include *Paratrygon* and *Plesiotrygon* not examined in this study).

(11) The family Gymnuridae is a monophyletic group defined by five synapomorphies; fusion of the proximal parts of the 1st and 2nd ceratobranchial cartilages; fusion of the proximal parts of the first 4 ceratobranchial cartilages; articulation of the pectoral radials; a precranial muscle present; and the depressor rostri muscle not converted into a tendon. This family includes only the two genera examined *Gymnura* and *Aetoplatea*.

(12) The family Myliobatidae is a monophyletic group defined by seven synapomorphies; an anteriorly located anterior foramen for the preorbital canal; a wing-like process on the mandibular cartilage; well-separated condyles for the last epibranchial and ceratobranchial cartilages; a triangular prepelvic process present; fusion of both intermandibularis posterior muscle; fusion of both coraco-hyoideus muscle; and a laterally located eye and spiracle. This family includes only the six genera examined *Myliobatis*, *Aetomylaeus*, *Aetobatus*, *Rhinoptera*, *Mobula*, and *Manta*.

## X. Acknowledgments

I am especially grateful to Prof. Kunio Amaoka, Hokkaido University, for his guidance during this study and his critical reading of the manuscript. My special thanks go also to Prof. Takashi Minoda, Hokkaido University, for critical reading of the manuscript. I wish to express my gratitude to Dr. Kazuhiro Nakaya, Hokkaido University, for his valuable advice and critical reading of the manuscript.

Dr. Graham S. Hardy (Osaka) kindly reviewed the manuscript.

I am deeply indebted to the following people for their kind assistance, and for the gift and on loan of materials: Drs. Eric M. Anderson, William N. Eschmeyer and Tomio Iwamoto, California Academy of Sciences; Dr. George H. Burgess, Florida State Museum; Dr. Gregor M. Cailliet, Moss Landing Marine Laboratory; Drs. John Casey and Harold Wes Pratt, NMFS, Narragansett Laboratory; Dr. Che-tsung Chen, National Taiwan College of Marine Science and Technology; Drs. Daniel M. Cohen, Jeffrey A. Seigel and Camm C. Swift, Natural History Museum of Los Angeles County; Drs. Shirou Fujita and Kiyoshi Fujita, Tokyo University of Fisheries; Drs. Victor G. Springer, Stanley H. Weitzman, Scott A. Schaefer, Susan L. Jewett

and the late Robert H. Gibbs, Jr., National Museum of Natural History, Smithsonian Institution; Dr. Terry Grande, Field Museum of Natural History at Chicago; Mrs. Hisoka Hiruda and Soichi Hagiwara, Shimoda Floating Aquarium; Mrs. Yuji Hasegawa and Koichi Kato, Izu Mito Sea Paradise; Dr. Hiroshi Hatanaka, Far Seas Fisheries Research Laboratory; Dr. Phillip C. Heemstra, J.L.B. Smith Institute of Ichthyology; Dr. Barbara Herzig, Naturhistorisches Museum at Wien; Drs. J.C. Hureau and Bernard Seret, Museum National d'Histoire Naturelle at Paris; Dr. Reizo Ishiyama (Tokyo); Drs. Tamotsu Iwai, Izumi Nakamura and Tetsuji Nakabo, Kyoto University; Mr. Hirokazu Kishimoto, Tokai University; Dr. John E. McCosker and Mr. Martin G. Wisner, Steinhart Aquarium; Drs. John D. McEachran and Tsutomu Miyake, Texas A & M University; Dr. Masaki Miya, Office for the Establishment of Prefectural Museum of Chiba; Dr. Hin-kiu Mok and Mr. Hung-junn Chang, National Sun Yat-Sen University; Dr. Giuseppe Notarbartolo-di-Sciara, Museo Civico di Storia Naturale at Milano; Dr. M.J.P. van Oijen, Rijksmuseum van Natuurlijke Historie; Dr. Hans J. Paepke, Museum of Natural History, Humboldt University; Dr. John R. Paxton, Australian Museum; Dr. John E. Randall, Bishop Museum; Dr. Shin-chieh Shen, National Taiwan University; Dr. Yoshihisa Shiobara, Marine Science Museum, Tokai University; Dr. Matthias Stehmann, Ichthyologie Institut für Seefischerei, Universität Hamburg; Dr. Toru Taniuchi and Mr. Hajime Ishihara, University of Tokyo; Dr. Thomas B. Thorson, University of Nebraska-Lincoln; Mrs. Senzo Uchida and Minoru Toda, Okinawa Expo. Aquarium; Drs. Teruya Uyeno and Keiichi Matsuura, National Science Museum at Tokyo; Dr. Peter H. Whitehead, British Museum (Natural History); Mrs. Hung-chia Yang and Jiunchern Lin, Taiwan Fisheries Research Institute; Dr. M-j Yu, Tunghai University at Taichung.

Finally, this study would not have been possible without the assistance of my wife, Noriko Nishida.

## XI. Literature cited

- Andres, A.V., J.M. Garcia Guzman and R. Munoz-Chapuli. 1987. Ventral cephalic musculature in elasmobranchs: some functional and phylogenetic implications. *Proc. V. Congr. Europ. Ichthyol.*, Stockholm 1985, 57-63.
- Arambourg, C. and L. Bertin. 1958. Class de chondrichthyens. Pages 2010-2056 in P.P. Grasse. *Traite de zoologie*, Paris.
- Berg, L. 1940. Classification of fishes, both recent and fossil. *Trudy. Zool. Inst. Leningr.*, 5: 87-517.
- Bertin, L. 1939. Essai de classification et de nomenclature des Poissons de la sous-classe des Selaciens. *Bull. Inst. Oceanogr. Monaco*, (775): 1-23.
- Bigelow, H.B. and W.C. Schroeder. 1953. Sawfish, guitarfish, skates and rays. Pages 1-514 in J. Tee-Van et al. eds. *Fishes of the western North Atlantic. Part 2. Mem. Sears Found. Mar. Res.*, Yale Univ., New Haven.
- Brooks, D.R., T.B. Thorson and M.A. Mayes. 1981. Freshwater stingrays (Potamotrygonidae) and their helminth parasites: testing hypothesis of evolution and coevolution. Pages 147-175 in V.A. Funk and D.R. Brooks, eds. *Advances in cladistics, proceeding of the first meeting of the Willi Hennig Society. The New York Botanical Garden, New York.*
- Capape, C. and M. Desoutter. 1979. Nouvelle description de *Aetomylaeus nichofii* (Bloch et Schneider, 1801) (Pisces, Myliobatidae). Premières observations biologiques. *Cahiers de l'Indo-pacifique*, 1: 305-322.

- Chu, Y.T., Q.W. Meng, A. Hu and S. Li. 1981. One new family, one new genus and four new species of elasmobranchiate fishes from the deep waters of South China Sea. *Oceanol. Limnol. Sinica*, 12: 103-114.
- Coles, R.J. 1916. Natural history notes on the Devilfish, *Manta birostris* (Walbaum) and *Mobula olfersi* (Müller). *Bull. Amer. Mus. Nat. Hist.*, 35: 649-657.
- Compagno, L.J.V. 1973. Interrelationships of living elasmobranchs. Pages 15-61 in P.H. Greenwood et al. eds. Interrelationships of fishes. Academic Press, London.
- Compagno, L.J.V. 1977. Phyletic relationships of living sharks and rays. *Amer. Zool.*, 17: 303-322.
- Compagno, L.J.V. 1988. Sharks of the order Carcharhiniiformes. Princeton University Press, Princeton, xxii + 486 + 68 + 26 pp., 35 pls.
- Compagno, L.J.V. and T.R. Roberts. 1982. Freshwater stingrays (Dasyatidae) of southwest Asia and New Guinea, with description of a new species of *Himantura* and reports of unidentified species. *Env. Biol. Fish.*, 7: 321-339.
- Compagno, L.J.V. and T.R. Roberts. 1984. Marine and freshwater stingrays (Dasyatidae) of west Africa, with description of a new species. *Proc. Calif. Acad. Sci.*, 43: 283-300.
- Compagno, L.J.V. and P.C. Heemstra. 1984. *Himantura draco*, a new species of stingray (Myliobatiformes: Dasyatidae) from South Africa, with a key to the Dasyatidae and the first record of *Dasyatis kuhlii* (Müller & Henle, 1841) from southern Africa. Special Publ. J.L.B. Smith Inst. *Ichthyol.*, (33): 1-17.
- Daniel, J.F. 1928. The elasmobranch fishes. University of California Press, Berkeley, 332 pp.
- De Beer, G.R. 1932. On the skeleton of the hyoid arch in rays and skates. *Quart. J. Micr. Sci.*, 75: 307-323, pls. 19-21.
- Dingerkus, G. 1986. Interrelationships of Orectolobiform sharks (Chondrichthyes: Selachii). Pages 227-245, in T. Uyeno, R. Arai, T. Taniuchi and K. Matsuura, eds. Proceedings of the Second International Conference on Indo-Pacific Fishes. Ichthyological Society of Japan, Tokyo.
- Dingerkus, G. and L.D. Uhler. 1977. Enzyme clearing of alcian blue stained whole small vertebrates for demonstration of cartilage. *Stain Technol.*, 52: 229-232.
- Edgeworth, F.H. 1935. The cranial muscles of vertebrates. Cambridge Univ. Press, Cambridge, viii + 493 pp.
- Eldredge, N. 1979. Cladism and common sense. Pages 165-198 in J. Cracraft and N. Eldredge eds. Phylogenetic patterns and the evolutionary process. Columbia Univ. Press, New York, viii + 349 pp.
- Fechhelm, J.D. and J.D. McEachran. 1984. A revision of the electric ray genus *Diplobatis* with notes on the interrelationships of Narcinidae (Chondrichthyes, Torpediniformes). *Bull. Florida State Mus., Biol. Sci.*, 29: 171-209.
- Feduccia, A. and B.H. Slaughter. 1974. Sexual dimorphism in skates (Rajidae) and its possible role in differential niche utilization. *Evolution*, 28: 164-168.
- Garman, S.W. 1877. On the pelvis and external sexual organs of Selachians, with special references to the new Genera *Potamotrygon* and *Disceus* (with descriptions). *Proc. Bost. soc. nat. hist.*, 19: 197-215.
- Garman, S.W. 1913. The Plagiostomia. *Mem. Mus. Comp. Zool. Harvard Coll.*, 36: 1-515, pls. 1-75.
- Gegenbaur, C. 1872. Untersuchungen zur vergleichenden Anatomie der Wirbelthiere. Drittes Heft. Das Kopfskelet der Selachier, ein Beitrag zur Erkenntniss der Genese des Kopfskeletes der Wirberthiere. Wilhelm Engelmann, Leipzig, 316 pp.
- Gill, T. 1909. The story of the devil-fish. *Smithsonian Miscellaneous Collections*, 52: 155-180.
- Gudger, E.W. 1914. History of the spotted eagle ray, *Aetobatus narinari*. Dept. Mar. Biol., Tortugas, Florida, Carnegie Inst. Washington, 6: 241-323.
- Günther, A. 1870. Catalogue of the fishes in the British Museum. Vol. 8. London, xxv + 549 pp.
- Halstead, B.W. and F.R. Modglin. 1950. A preliminary report on the venom apparatus of the Bat-ray, *Holorhinus californicus*. *Copeia*, 1950: 165-175.
- Hamdy, A.R. 1959a. The head skeleton of *Rhinoptera bonasus* (Mitchill). *Proc. Egypt. Acad. Sci.*, 14: 74-81, 1-2 pls.
- Hamdy, A.R. 1959b. The morphological significance of the labial cartilage in Selachii. *Proc. Egypt. Acad. Sci.*, 14: 82-88.

- Hamdy, A.R. 1962a. The development of the mandibular arch of *Rhynchobatus djiddensis*. *Proc. Egypt. Acad. Sci.*, 17: 1-3.
- Hamdy, A.R. 1962b. Studies on the orbital region in selachian neurocrania. *Proc. Egypt. Acad. Sci.*, 17: 4-7.
- Hamdy, A.R. and M.S. Khalil. 1963a. The connections and relations of the neurocranium and viscerocranium of *Rhinobatus cranulatus*, *Raia miraletus*, *Pteroplatea altavela*, *Aetomylus milvus*, and *Stoasodon narinari*. *Proc. Egypt Acad. Sci.*, 17: 60-69.
- Hamdy, A.R. and M.S. Khalil. 1963b. The hyoid arch in Batoidei. *Proc. Egypt Acad. Sci.*, 17: 70-73.
- Hecht, M.K. and J.L. Edwards. 1977. The methodology of phylogenetic inference above the species level. Pages 3-51 in M.K. Hecht, P.C. Goody and B.M. Hecht eds. Major patterns in vertebrate evolution. Plenum, New York, ix+908 pp.
- Heemstra, P.C. and M.M. Smith. 1980. Hexatrygonidae, a new family of stingrays (Myliobatiformes: Batoidea) from South Africa, with comments on the classification of batoid fishes. *Ichthyol.*, (43): 1-17.
- Hennig, W. 1966. Phylogenetic systematics. Univ. Illinois Press, Urbana, 263 pp.
- Hennig, W. 1975. "Cladistic analysis or cladistic classification?": a reply to Ernst Mayr. *Syst. Zool.*, 24: 244-256.
- Holloway, J.E., N.C. Bunker and B.W. Halstead. 1953. The venom of *Urobatis halleri* (Cooper), the round stingray. *Calif. Fish and Game*, 39: 77-82.
- Holmgren, N. 1940. Studies on the head in fishes. Embryological, morphological and phylogenetical researches. Part 1: development of the skull in sharks and rays. *Acta. Zool.*, 21: 51-267.
- Holmgren, N. 1941. Studies on the head in fishes. Part II: Comparative anatomy of the adult selachian skull, with remarks on the dorsal fins in sharks. *Acta. Zool.*, 22: 1-100.
- Hully, P.A. 1972. The origin, interrelationship and distribution of southern African Rajidae (Chondrichthyes, Batoidei). *Ann. South African Mus.*, 60: 1-103.
- Ishihara, H. and S. Kishida. 1984. First record of the sixgill stingray *Hexatrygon longirostra* from Japan. *Japan. J. Ichthyol.*, 30: 452-454.
- Jordan, D.S. 1923. A classification of fishes including families and genera as far as known. Stanford Univ. Publ. (Biol. Sci.), 3: 77-243.
- Kluge, A.G. and J.S. Farris. 1969. Quantitative phyletics and the evolution of anurans. *Syst. Zool.*, 18: 1-32.
- Lamarca, M.J. 1964. The functional anatomy of the clasper gland of the yellow stingray, *Urolophus jamaicensis* (Cuvier). *J. Morph.*, 114: 303-324.
- Leviton, A.E., R.H. Gibbs, Jr., E. Heal and C.E. Dawson. 1985. Standards in herpetology and ichthyology: Part 1. Standard symbolic codes for institutional resource collections in herpetology and ichthyology. *Copeia*, 1985: 802-832.
- Luther, A.F. 1909. Untersuchungen über die vom N. trigeminus innervierte Muskulatur der Selachier (Haie und Rochen) unter Berücksichtigung ihrer Beziehungen zu benachbarten Organen. *Acta. Soc. Sci. Fenn.*, 36: 1-176.
- Maddison, W.P., M.J. Donoghue and D.R. Maddison. 1984. Outgroup analysis and parsimony. *Syst. Zool.*, 33: 83-103.
- Maisey, J.G. 1980. An evaluation of jaw suspension in sharks. *Amer. Mus. Novitat.*, (2706): 1-17.
- Maisey, J.G. 1984a. Higher elasmobranch phylogeny and biostratigraphy. *Zool. J. Linn. Soc.*, 82: 33-54.
- Maisey, J.G. 1984b. Chondrichthyan phylogeny: a look at the evidence. *J. Vert. Paleont.*, 4: 359-371.
- Marion, G.E. 1905. Mandibular and pharyngeal muscles of *Acanthias* and *Raja*. *Amer. Nat.*, 39: 891-924.
- Martin, L.K. 1982. Growth and reproduction of the bat ray, *Myliobatis californica* Gill, in California. M.A. Thesis, San Jose State Univ. and Moss Landing Marine Lab., California, 87 pp.
- Maslin, T.P. 1952. Morphological criteria of phyletic relationships. *Syst. Zool.*, 1: 49-70.
- Mayr, E. 1974. Cladistic analysis or cladistic classification? *Z. Zool. Syst. Evol. Forsch.*, 12: 94-128.
- McEachran, J.D. 1984. Anatomical investigation of the New Zealand skates *Bathyraja asperula* and

- B. spinifera*, with an evaluation of their classification within the Rajoidei (Chondrichthyes). *Copeia*, 1984 : 45-58.
- McEachran, J.D. and L.J.V. Compagno. 1979. A further description of *Gurgesiella furvescens* with comments on the interrelationships of Gurgesiellidae and Pseudorajidae (Pisces, Rajoidei). *Bull. Mar. Sci.*, 29 : 530-553.
- McEachran, J.D. and T. Miyake. 1987. A new species of skate of the genus *Breviraja* from off Nova Scotia, with comments on the status of *Breviraja* and *Neoraja* (Chondrichthyes, Rajoidei). *Copeia*, 1987 : 409-417.
- Melouk, M.A. 1949. On the relation between the vertebral column and the occipital region of the chondrocranium in the Selachii and its phylogenetic significance. *Publ. Mar. Biol. St., Ghardaqa, Egypt*, (6) : 46-51.
- Miyake, T. and J.D. McEachran. 1986. Taxonomy of the stingray genus *Urotrygon* (Myliobatiformes : Urolophidae) : preliminary results based on external morphology. Pages 291-302 in T. Uyeno, R. Arai, T. Taniuchi and K. Matsuura, eds. *Indo-Pacific fish biology : Proc. Second Int'l. Conf. Indo-Pacific Fishes ; July-August, 1985*. Ichthyological Society of Japan, Tokyo.
- Moss, S.A. 1984. *Sharks*. An introduction for the amateur naturalist. Prentice-Hall, New Jersey, x+246 pp.
- Müller, J. and J. Henle. 1841. Systematische Beschreibung der Plagiostomen. Veit und Comp., Berlin, xxii+200 pp., 60 pls.
- Nair, R.V. and R. Soundararajan. 1973. On the occurrence of the deep sea stingray *Urotrygon daviesi* Wallace in Indian waters. *Indian J. Fish.*, 20 : 245-249.
- Nakaya, K. 1975. Taxonomy, comparative anatomy and phylogeny of Japanese catsharks, Scyliorhinidae. *Mem. Fac. Fish. Hokkaido Univ.*, 23 : 1-94.
- Nakaya, K. 1982. Dasyatidae. Pages 56-57 in O. Okamura, K. Amaoka and F. Mitani, eds. *Fishes of the Kyushu Palau Ridge and Tosa Bay*. Japan Fish. Res. Conserv. Assoc., Tokyo.
- Nakaya, K. 1984. Dasyatidae. Pages 70-71, 310 in O. Okamura and T. Kitajima, eds. *Fishes of the Okinawa Trough and the adjacent waters I*. Japan Fish. Res. Conserv. Assoc., Tokyo.
- Nishida, K. and K. Nakaya. 1988a. A new species of the genus *Dasyatis* (Elasmobranchii : Dasyatidae) from southern Japan and lectotype designation of *D. zugei*. *Japan. J. Ichthyol.*, 35 : 115-123.
- Nishida, K. and K. Nakaya. 1988b. *Dasyatis izuensis*, a new stingray from the Izu Peninsula, Japan. *Japan. J. Ichthyol.*, 35 : 227-235.
- Nelson, G.J. 1970. Outline of a theory of comparative biology. *Syst. Zool.*, 19 : 373-384.
- Nelson, J.S. 1984. *Fishes of the world*. John Wiley and Sons, Inc., New York, 2nd ed., xv+523 pp.
- Norman, J.R. 1966. A draft synopsis of the orders, families and genera of recent fishes and fish-like vertebrates. British Museum (Natural History), London, 649 pp.
- Notarbartolo-Di-Sciara, G. 1987. A revisionary study of the genus *Mobula* Rafinesque, 1810 (Chondrichthyes : Mobulidae) with the description of a new species. *Zool. Journ. Linn. Soc.*, 91 : 1-91.
- Rosa, R.S., H.P. Castello and T.B. Thorson. 1987. *Plesiotrygon iwamae*, a new genus and species of neotropical freshwater stingray (Chondrichthyes : Potamotrygonidae). *Copeia*, 1987 : 447-458.
- Sakamoto, K. 1984. Interrelationships of the family Pleuronectidae (Pisces : Pleuronectiformes). *Mem. Fac. Fish. Hokkaido Univ.*, 31 : 95-215.
- Sawada, Y. 1982. Phylogeny and zoogeography of the superfamily Cobitoidea (Cyprinoidei, Cypriniformes). *Mem. Fac. Fish. Hokkaido Univ.*, 28 : 65-223.
- Schaeffer, B. 1967. Comments on elasmobranch evolution. Pages 3-35 in P.W. Gilbert, R.F. Mathewson and D.P. Rall, eds. *Sharks, skates and rays*. Johns Hopkins Press, Baltimore.
- Seret, B. 1986. Classification et phylogenese des chondrichthyens. *Oceanis*, 12 : 161-180.
- Shen, S.C. and C. Liu. 1984. A new stingray of the genus *Hexatrygon* from Taiwan. *Acta Oceanogr. Taiwanica*, (15) : 201-206.
- Stauch, A. and M. Blanc. 1962. Description d'un selacien rajiforme des eaux douces du Nord-Cameroun, *Potamotrygon garouaensis* n. sp. *Bull. Mus. Natn. Hist. Nat.* (Paris), 34 : 166-171.
- Stehmann, M. 1970. Vergleichend morphologische und anatomische Untersuchungen zur Neuord-

- nung der Systematik der nordostatlantischen Rajidae (Chondrichthyes, Batoidei). *Arch. Fischwiss.*, **21**: 73-164, pls. 1-27.
- Stehmann, M. 1981. Batoid fishes. Pages 1-8 in W. Fischer, G. Bianchi and W.B. Scott eds. FAO species identification sheets for fishery purposes. Eastern Central Atlantic. Fishing Area 34.
- Thorson, T.B. and D.E. Watson. 1975. Reassignment of the African freshwater stingray, *Potamotrygon garouaensis*, to the genus *Dasyatis*, on physiologic and morphologic grounds. *Copeia*, **1975**: 701-712.
- Tinker, S.W. 1978. Fishes of Hawaii: A handbook of the marine fishes of Hawaii and the Central Pacific Ocean. Hawaiian Service, Inc., Honolulu, **xxxx**+532+**xxxvi** pp., 32 pls.
- Vetter, B. 1878. Untersuchungen zur vergleichenden Anatomie der Kiemen-und Kiefermuskulatur der Fische. *Jena. Zeitschr. Naturw.*, **12**: 431-550.
- Wallace, J.H. 1967. The batoid fishes of the east coast of southern Africa. Part II: manta, eagle, duckbill, cownose, butterfly, and sting rays. *Oceanogr. Res. Inst. Invest. Rep.*, (16): 1-56.
- Watrous, L.E. and Q.D. Wheeler. 1981. The out-group comparison method of character analysis. *Syst. Zool.*, **30**: 1-11.
- White, E.G. 1937. Interrelationships of the elasmobranchs with a key to the order Galea. *Bull. Amer. Mus. Nat. Hist.*, **74**: 25-138, 51 pls.
- Wiley, E.O. 1981. Phylogenetics. The theory and practice of phylogenetic systematics. John Wiley and Sons, New York, **xv**+439 pp.
- Wourms, J.P. 1977. Reproduction and development in chondrichthyan fishes. *Amer. Zool.*, **17**: 379-410.
- Yabe, M. 1985. Comparative osteology and myology of the superfamily Cottoidea (Pisces: Scorpaeniformes), and its phylogenetic classification. *Mem. Fac. Fish. Hokkaido Univ.*, **32**: 1-130.
- Zangerl, R. 1973. Interrelationships of early chondrichthyans. Pages 1-14 in P.H. Greenwood, R.S. Miles and C. Patterson eds. Interrelationships of fishes. Academic Press, London.