



Title	Devices of Simple Plankton Apparatus III
Author(s)	MOTODA, Sigeru; 元田, 茂
Citation	北海道大學水産學部研究彙報, 18(1), 3-8
Issue Date	1967-05
Doc URL	<a href="https://hdl.handle.net/2115/23296">https://hdl.handle.net/2115/23296</a>
Type	departmental bulletin paper
File Information	18(1)_P3-8.pdf



## Devices of Simple Plankton Apparatus III

Sigeru MOTODA\*

This is the third paper describing devices of simple plankton gear, water samplers and other biological tools (ref. to Motoda 1959, 1963). The ideas involve neither application of recently developed mechanical or electrical equipment, nor hydrodynamic calculation. Tools described are of simple construction, and have been proven by trial at sea to be certainly useful and satisfactorily practical at least for the limited purpose.

### 1. Horizontal Closing Net with Triangular Frame

(三角枠付水平閉鎖ネット)

(Pl. I, Figs. 1-4, Pl. III, Figs. 1-5)

It was found by several sea trials that the closing system of the net in the "Horizontal square net fixed on triangular frame" (Motoda 1963) is not always

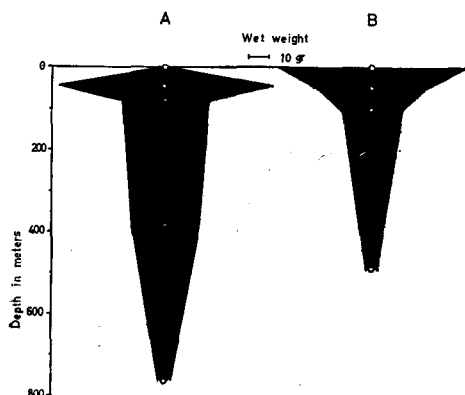

Fig. 1. Examples of vertical distribution of zooplankton biomass in daytime and at night as observed by simultaneous horizontal tow through several depths with the "Horizontal closing net with triangular frame." "Oshoro Maru" cruise 13 to the southeast of Kushiro, Hokkaido (in Oyashio Current)

A: Day collection at Sta. Os 2, 42°12'N, 145°38'E, 2:43-4:34 p.m. May 8, 1965. Depth of tow: 0 m, 38 m, 77 m, 385 m, 766 m

B: Night collection at Sta. Os 4, 42°37'N, 144°55'E, 0:59-2:25 a.m. May 9, 1965. Depth of tow: 0 m, 48 m, 97 m, 486 m

reliable, so the square net frame was replaced by a ring frame. A conical net attached to the ring frame can be closed by being suspended with a trunk ring after releasing the mouth ring (Juday type closing system). This method of closing is perfectly reliable, although it may allow the ejection of a certain volume of water from inside the net when the mouth ring is released, resulting in certain loss of the samples. The net is lowered in open position (Pl. I, Fig. 1), and hauled up in closed position (Pl. I, Figs. 3, 4, Pl. III, Fig. 4) after towing it horizontally (Pl. I, Fig. 2, Pl. III, Fig. 3). According to our experience, contamination of material from other depths than the desired depth hardly ever occurs during the lowering of the net in open position, in which the mouth ring of the net is fixed to the triangular frame. This is

\* Faculty of Fisheries, Hokkaido University, Hakodate, Hokkaido

the main point of this device. Several nets of this type towed horizontally at the same time will yield comparable samples from different depths, except when an irregular strong undercurrent exists (Pl. III, Fig. 5). This method of collecting samples is particularly appropriate for studying the detailed vertical distribution of zooplankton in shallow water.

Examples of the results of sampling with this type of net are shown in Fig. 1 in which the difference of zooplankton biomass at several depths in the upper 100 meters between daytime and night is clearly illustrated.

## 2. Horizontal Opening-Closing Net

(水平開閉ネット)

(Pl. I, Figs. 5-7, Pl. IV, Figs. 1-5)

An ideal horizontal sampling through a desired depth can be made by the use of an opening-closing net. Various types of double release mechanisms and nets have been employed. However, not only is such gear usually very troublesome to use, but also the double release action and opening and closing of the net are often unsuccessful. The new double release device presented here (Pl. IV, Figs. 1, 2) was proven to almost always work reliably. The use of two messengers of the same size is an advantage. The net is wrapped with a cover during the lowering, so that entangling of the net and lines with the wire cable can be prevented (Pl. IV, Fig. 3).

## 3. High-Speed Surface Plankton Sampler

(高速表層プランクトン採集器)

(Pl. I, Figs. 8, 9, Pl. IV, Fig. 6)

This is named "Underway plankton catcher, model VII" (cf. Motoda 1959, p. 86) or "Shark high-speed plankton sampler" (Anonymous 1959, p. 64). No weight is attached to the head piece as in models IV and V (Motoda 1959). Trial tow of the sampler at 10-12 knots by paying out the warp as long as 200 meters indicated a very stable run of the sampler. If desired, the sampler can be towed at a certain depth by suspending a depressor below. As examples, the surface zooplankton biomass, excluding fish, fish larvae, jellyfish and other relatively large organisms, estimated by high-speed tow with this type of sampler are as follows:

1. Area:	Northern North Pacific and Bering Sea
Year and month:	May-August 1965 ("Oshoro Maru" Cruise 14)
Number of stations:	36

- |    |                             |  |
|----|-----------------------------|--|
|    | Mesh size of net:           | 1.0 mm×1.0 mm                              |
|    | Mean wet weight of samples: | 153 gr/1000 m <sup>3</sup>                 |
| 2. | Area:                       | Bering Sea                                 |
|    | Year and month:             | June-August 1966 ("Oshoro Maru" Cruise 19) |
|    | Number of stations:         | 37   |
|    | Mesh size of net:           | 2.0 mm×2.0 mm                              |
|    | Mean wet weight of samples: | 237 gr/1000 m <sup>3</sup>                 |
| 3. | Area:                       | Indian Ocean                               |
|    | Year and month:             | December 1963 ("Oshoro Maru" Cruise 16)    |
|    | Number of stations:         | 11   |
|    | Mesh size of net:           | 1.0 mm×1.0 mm                              |
|    | Mean wet weight of samples: | 21 gr/1000 m <sup>3</sup>                  |

A remarkable difference in zooplankton productivity between the Bering Sea and the Indian Ocean is shown.

#### 4. Hanging Wire Clinometer

(懸垂式ワイヤ傾角計)

(Pl. I, Fig. 10, Pl. IV, Fig. 7)

The wire clinometer described before (Motoda 1963, p. 158) was remodelled. It now has a long stalk. Regardless of the direction of the wire cable, even if it is positioned far out from the side or stern of the ship, the angle of the wire cable can be easily measured by the use of this type of clinometer. The semicircular disc is always suspended downwards irrespective of the direction of the stalk, so that a needle with a weight always indicates the real angle of the wire cable against the vertical line. The semicircular disc should have holes to eliminate wind resistance, and the weight of the needle should be sufficiently heavy to keep the needle pointing downwards.

#### 5. Plankton Sample Strainer

(プランクトン標本濾過器)

(Pl. II, Figs. 1, 2, Pl. IV, Figs. 8-12)

It is felt that the "Plankton sample aspiration filtering apparatus" (Motoda 1959, p. 91) is rather complicated in structure and not practical for rapid processing of a large amount of zooplankton samples on board. The tool described here is an improvement of the "Plankton sample strainer" presented in the previous paper (Motoda 1963, p. 160). A hole on the lower plastic cylinder (Pl.

IV, Fig. 9, g) is connected with a rubber tube which comes from an aspirator. A short rubber tube is connected with another hole positioned at the opposite side of the cylinder. By pressing the opposite tube with one's fingers the vacuum pressure can be adjusted so as not to damage the samples on the filter.

#### 6. Paired Van Dorn Water Sampler

(双筒ブンドン採水器)

(Pl. II, Figs. 3, 4, Pl. V, Figs. 1-3)

Many varieties of the Van Dorn water samplers have been designed and used by various workers. In practice at sea the following points are necessary: (1) It must be perfectly water tight, especially when the sampler is hauled above the sea surface. If the cylinder is too long, a pulling rubber string will not keep the upper and lower lids tight against the openings of the cylinder; (2) The water in the cylinder should be completely renewed successively during the lowering of the sampler. Obstructions for the water passing through the cylinder should be reduced as much as possible; (3) Easy attachment and detachment of the cylinders from the frame of the sampler; (4) Lids (plumber's friend) of cylinders can be hooked on the release with little effort. Cylinders filled with the water should be light enough so that a man may carry one in each hand keeping it in horizontal position on the deck. A capacity of 13 liters or so for one cylinder may be the maximum size; (6) Reliable action of releasing mechanism of triggers; (7) For saving time in sampling from several depths, especially sampling from the great depths, it is desirable to attach several samplers in various positions on a single wire cable. A messenger weight suspended under each sampler can be released by the strike of the messenger on the upper trigger.

Designs of Van Dorn water samplers described here are not based on new ideas, but are of slight modification of existing tools for easy construction and light handling at sea. Reliability of closing and water tightness of the closed cylinder in the "Paired Van Dorn water sampler" was successfully tested. Capacity of each cylinder is 12 liters or more. This type of sampler has been used in the Kuroshio Expedition of the "Oshoro Maru" with no trouble. If it is desired to prevent the possible eddy motion of the water which may occur in the corner on the inside of the cylinder, the corner can be remodelled to a sloped shape.

### 7. Single Van Dorn Water Sampler

(単筒ブンドン採水器)

(Pl. II, Figs. 5, 6, Pl. V, Figs. 4, 5)

Some like a huge water sampler to obtain a large amount of water by one haul from deep water. It is not only dangerous to suspend such a huge sampler filled with water with a thin wire cable above the sea surface, but also very difficult to handle a heavy clumsy sampler on deck. The model described here is about 17 liters in capacity. Only one sampler can be attached to the end of the wire cable. Because the lower lid (plumber's friend) (Pl. V, Fig. 4, e) is smaller than the upper lid and set inside the cylinder near the opening of the base plate, this lid is tightly pushed by the water inside against the opening when released. This is very important when the sampler is raised above sea surface. An arm put in the upper portion (Pl. V, Fig. 5, g) is useful to raise the upper lid for hanging to the release. One limitation of this sampler is the narrowness of the passage for water on the inside of the cylinder, which might prevent the water from passing freely from the lower opening to the upper opening during the lowering of the sampler.

### 8. Narrow Van Dorn Water Sampler

(細型ブンドン採水器)

(Pl. II, Figs. 7, 8, Pl. V, Fig. 6)

There is no obstruction in the water passage inside the cylinder. Raising of upper lid and lowering of lower lid is very easy by means of the upper and lower arms (Pl. V, Fig. 6, f, j).

### 9. Simple Van Dorn Water Sampler

(簡易ブンドン採水器)

(Pl. II, Figs. 9, 10, Pl. V, Fig. 7)

The structure is very simple. The trigger is simply composed of a rod with a bent end and a hanger at another end, but the action is good. The sampler is useful for observations in shallow water or lakes.

Designing of simple apparatus is certainly a hobby-like work of marine biologists. Among the devices presented before (Motoda 1959, 1963) and in the present paper, the writer believes that the following items which have been proven to be practically useful, can be recommended to the biologists working at sea or in lakes according to their special purpose:

1. Double releasing mechanism with horizontal bar (Motoda 1959, p. 83)
2. Simple underway plankton catcher, model IV, V (Motoda 1959, p. 85)
3. Plankton sample splitting box and splitting cylinder (Motoda 1959, p. 89)
4. Underwater wire clinometer (Motoda 1963, p. 159)
5. Horizontal closing net with triangular frame (this paper)
6. Double release for horizontal opening-closing net (this paper)
7. Hanging wire clinometer (this paper)
8. Plankton sample strainer (this paper)
9. Various types of Van Dorn water samplers (this paper)

The writer is greatly indebted to colleagues for their cooperation in testing the apparatus at sea and in the laboratory. Presentation of unpublished data by Messrs. Y. Morioka, K. Koyama and K. Sasaki is greatly appreciated.

#### Literature cited

- Anonymous 1965. *Data Record of Oceanographic Observations and Exploratory Fishing*.  
Fac. Fish., Hokkaido Univ. No. 9.
- Anonymous 1966. *Ibid.* No. 10.
- Motoda, S. 1959. Devices of simple plankton apparatus. *Mem. Fac. Fish., Hokkaido Univ.*  
7 (1/2), 73-94.
- Motoda, S. 1963. Ditto. II. *Bull. Fac. Fish., Hokkaido Univ.* 14 (3), 152-162.

## **Explanation of Plates**

## PLATE I

- 1-4. Horizontal closing net with triangular frame
  1. In position to be lowered from deck
  2. In position being towed horizontally in the water
  3. In closed position in the water
  4. In position to be raised from the sea surface
- 5-7. Horizontal opening-closing net
  5. In position to be lowered
  6. In position being towed horizontally
  7. In closed position
- 8-9. High-speed surface plankton sampler
  8. On deck
  9. Hauling onto deck
10. Hanging wire clinometer

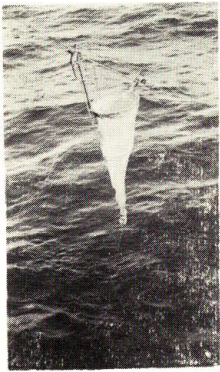

1

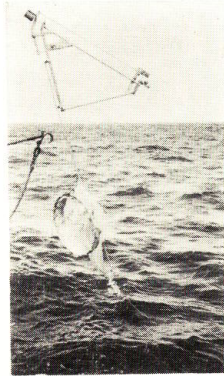

4

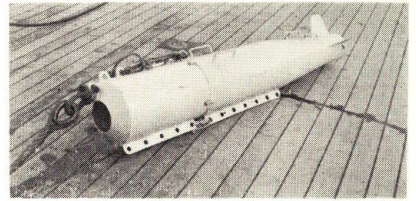

8

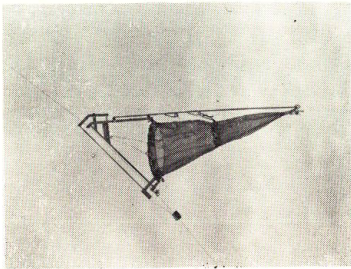

2

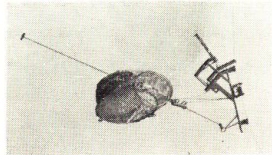

5



9

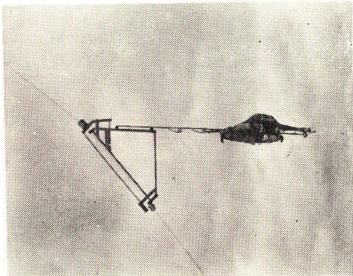

3

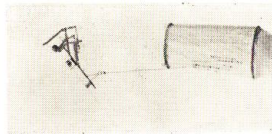

6



7



10

## PLATE II

- 1-2. Plankton sample strainer
  1. Whole assembly
  2. Parts
- 3-4. Paired Van Dorn water sampler (ca. 24 liters in two cylinders)
  3. In open position
  4. In closed position
- 5-6. Single Van Dorn water sampler (ca. 17 liters)
  5. In open position
  6. In closed position
- 7-8. Narrow Van Dorn water sampler (ca. 8.5 liters)
  7. In open position
  8. In closed position
- 9-10. Simple Van Dorn water sampler (ca. 2.3 liters)
  9. In open position
  10. In closed position

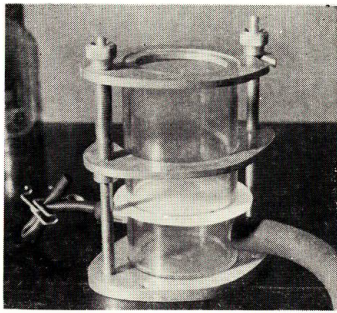

1

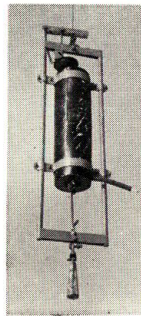

5

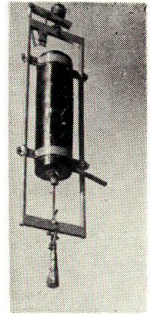

6

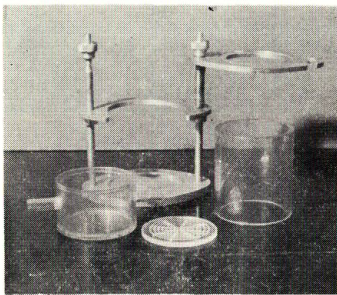

2

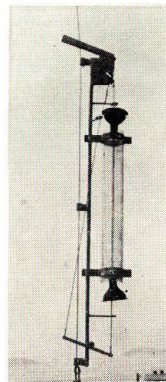

7

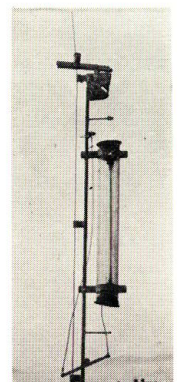

8

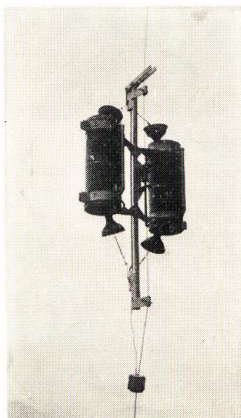

3

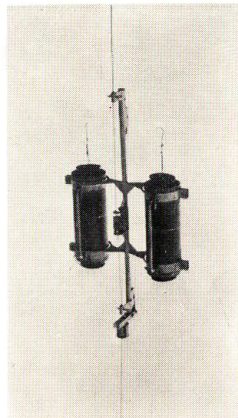

4

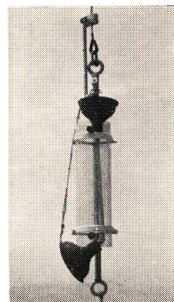

9

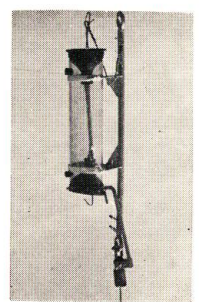

10

### PLATE III

- 1-4. Horizontal closing net with triangular frame
  1. Mouth ring and trunk ring
  2. Profile of whole assembly
    - a. Trigger, b. Wire cable, c. Supporting rod, d. Central rod, e. Messenger release, f. Wire clip, g. Bridle, h. Upper hook on the mouth ring, m. Mouth ring, n. Filtering cloth, o. Trunk ring
  3. Sketch of the net in open position
    - a. Wire cable, b. Trigger, c. Messenger release, d. Supporting rod, e. Wire clip, f. Messenger, g. Mouth ring, h. Trunk ring
  4. Sketch of the net in closed position
    - a. Mouth ring line which keeps the mouth ring parallel to the current after releasing
5. Sketch of simultaneous horizontal tow with seven nets

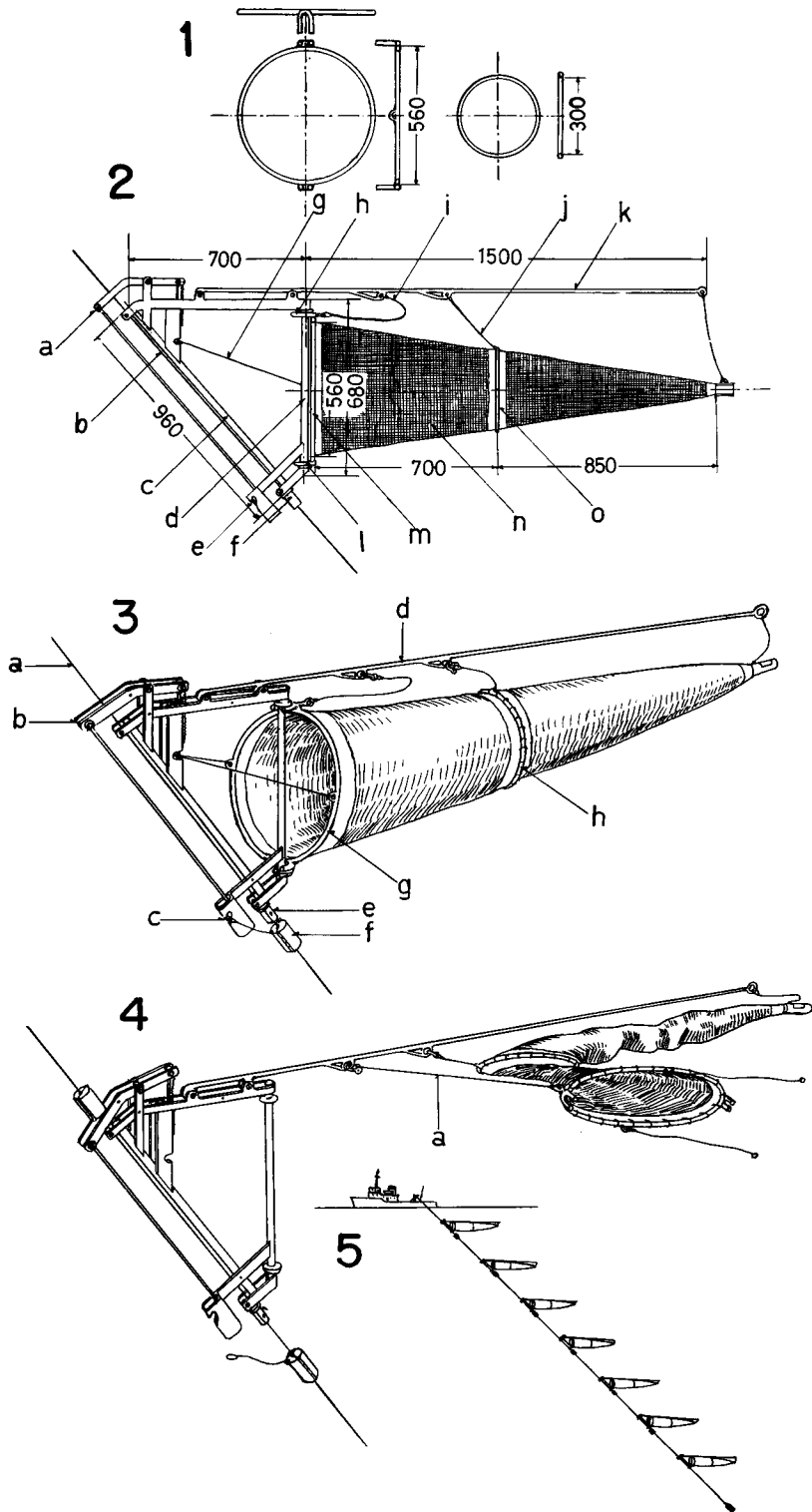

MOTODA: Devices of Simple Plankton Apparatus. III

## PLATE IV

- 1-5. Horizontal opening-closing net
  1. Profile of double release
  2. Sketch of double release
    - a. Second trigger, b. Second release, c. First release, d. First trigger, e. Wire cable, f. Wire clip
  3. Sketch of the net in closed position before sampling
    - a. Wire clip, b. Canvas cover wrapping the truncate canvas cone, net and cod end, c. Supporting rod, d. Sliding tube connected with the trunk ring and first release
  4. Sketch of the net in open position while sampling
    - a. First messenger, b. Mouth ring, c. Truncate canvas cone, d. Trunk ring, e. Canvas cover, f. Net
  5. Sketch of the net in closed position after collecting samples
    - a. Second messenger, b. First messenger, c. Mouth ring line
6. High-speed surface plankton sampler (Underway plankton catcher, model VII)
  - a. Junction of case, b. Net, c. Flow-meter case
7. Hanging wire clinometer
- 8-12. Plankton sample strainer
  8. Plastic pad to be placed under filter
  9. Profile
    - a. Upper metal disc, b. Supporting metal rod, c. Upper plastic cylinder, d. Middle metal disc, e. Stopper, f. Filter, g. Hole connected with rubber tube, h. Lower plastic cylinder, i. Base metal disc
  10. Upper metal disc
  11. Middle metal disc
  12. Base metal disc



## PLATE V

- 1-3. Paired Van Dorn water sampler
  1. Profile and horizontal section
  2. Transverse section
    - a. Wire cable
  3. Sketch
    - a. Wire cable, b. Trigger, c. Upper lid, d. Wire clip, e. Lower lid, f. Messenger, g. Upper release, h. Supporting central rod, i. Plastic cylinder, j. Lower release, k. Messenger release
- 4-5. Single Van Dorn water sampler
  4. Profile
    - a. Upper large lid, b. Cotton string, c. Rubber string, d. Cotton string, e. Lower small lid, f. Rubber string
  5. Sketch
    - a. Wire cable, b. Trigger, c. Release, d. Upper large lid, e. Plastic cylinder, f. Supporting frame, g. Arm
6. Sketch of narrow Van Dorn water sampler
  - a. Wire cable, b. Trigger, c. Wire clip, d. Supporting rod, e. Release, f. Upper arm, g. Upper lid, h. Plastic cylinder, i. Lower lid
7. Sketch of simple Van Dorn water sampler
  - a. Wire cable, b. Trigger, c. Upper lid, d. Plastic cylinder, e. Lower lid, f. Supporting rod

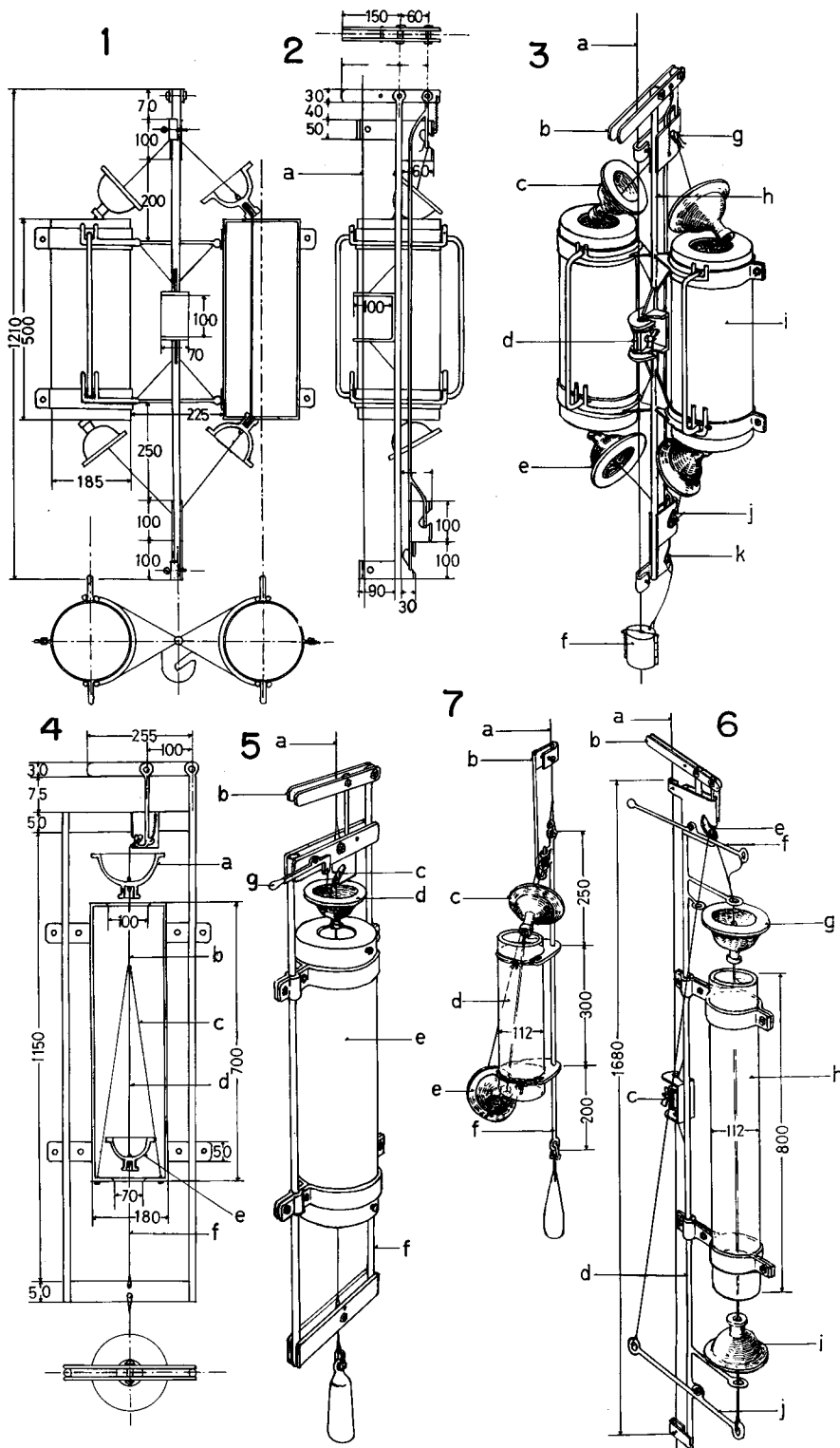

MOTODA: Devices of Simple Plankton Apparatus. III