



Title	Validity and visualization of a numerical model used to determine dynamic configurations of fishing nets
Author(s)	Suzuki, Katsuya; 鈴木, 勝也; Takagi, Tsutomu et al.
Citation	Fisheries Science, 69(4), 695-705 https://doi.org/10.1046/j.1444-2906.2003.00676.x
Issue Date	2003-08
Doc URL	https://hdl.handle.net/2115/380
Rights	© 2003 公益社団法人日本水産学会
Type	journal article
File Information	FS_69_695-705_2003_Fig.pdf, 図



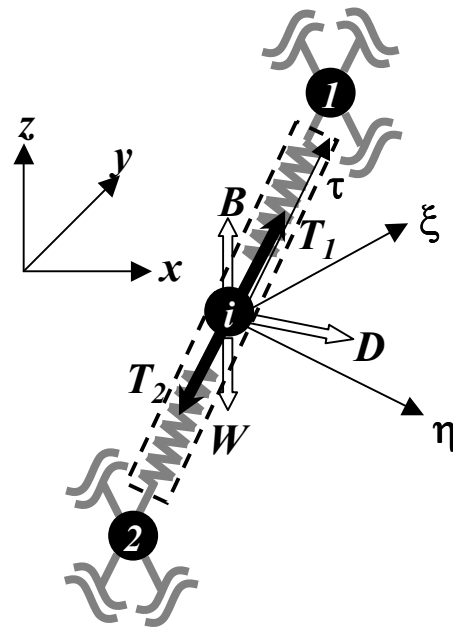

Fig.1
K Suzuki et al.

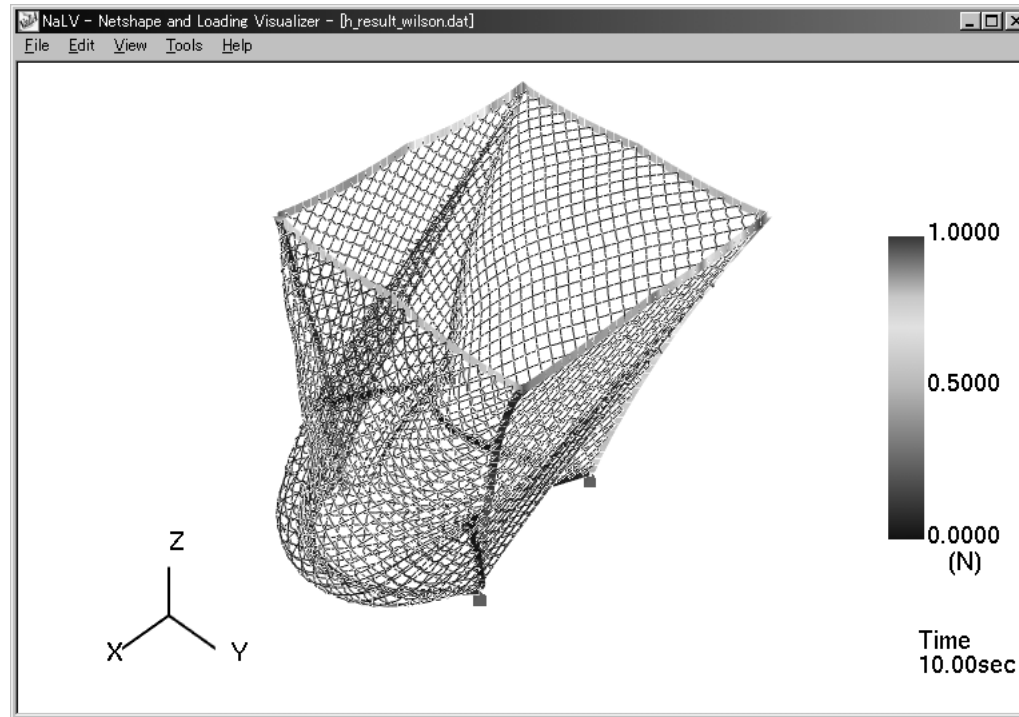

Fig.2
K Suzuki et al.

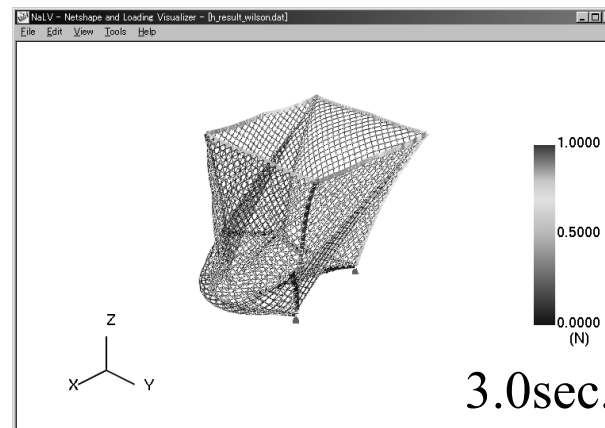
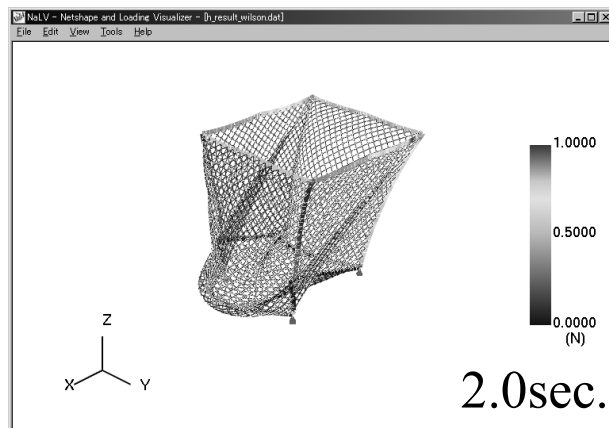
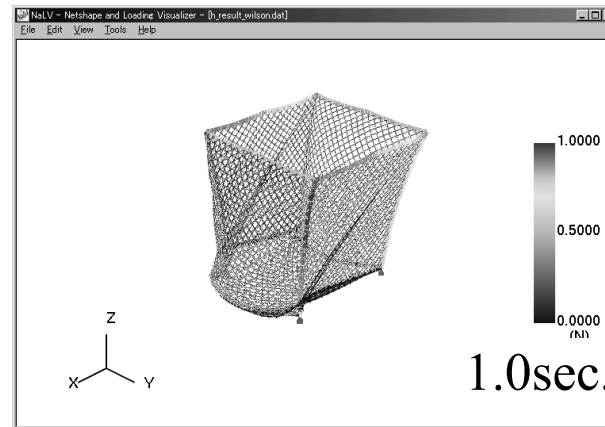
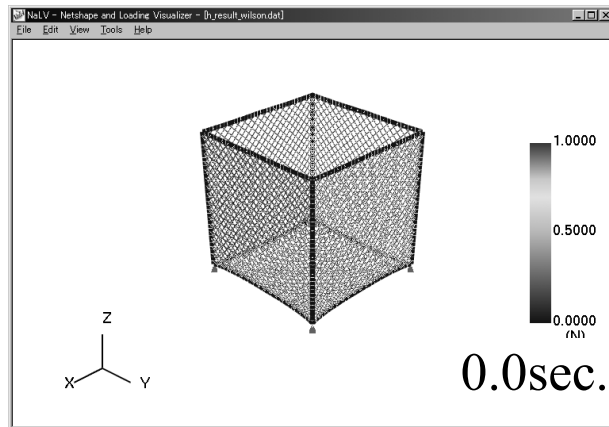

Fig.3
K Suzuki et al.

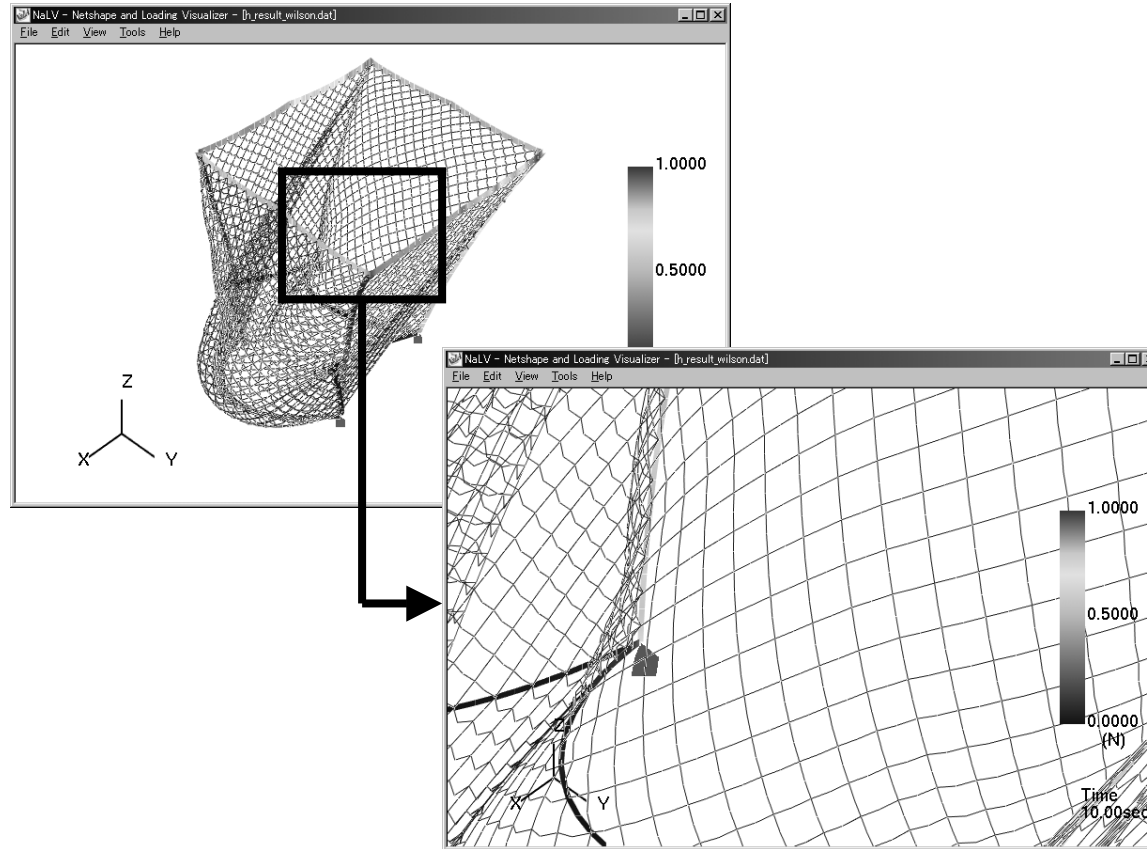

Fig.4
K Suzuki et al.

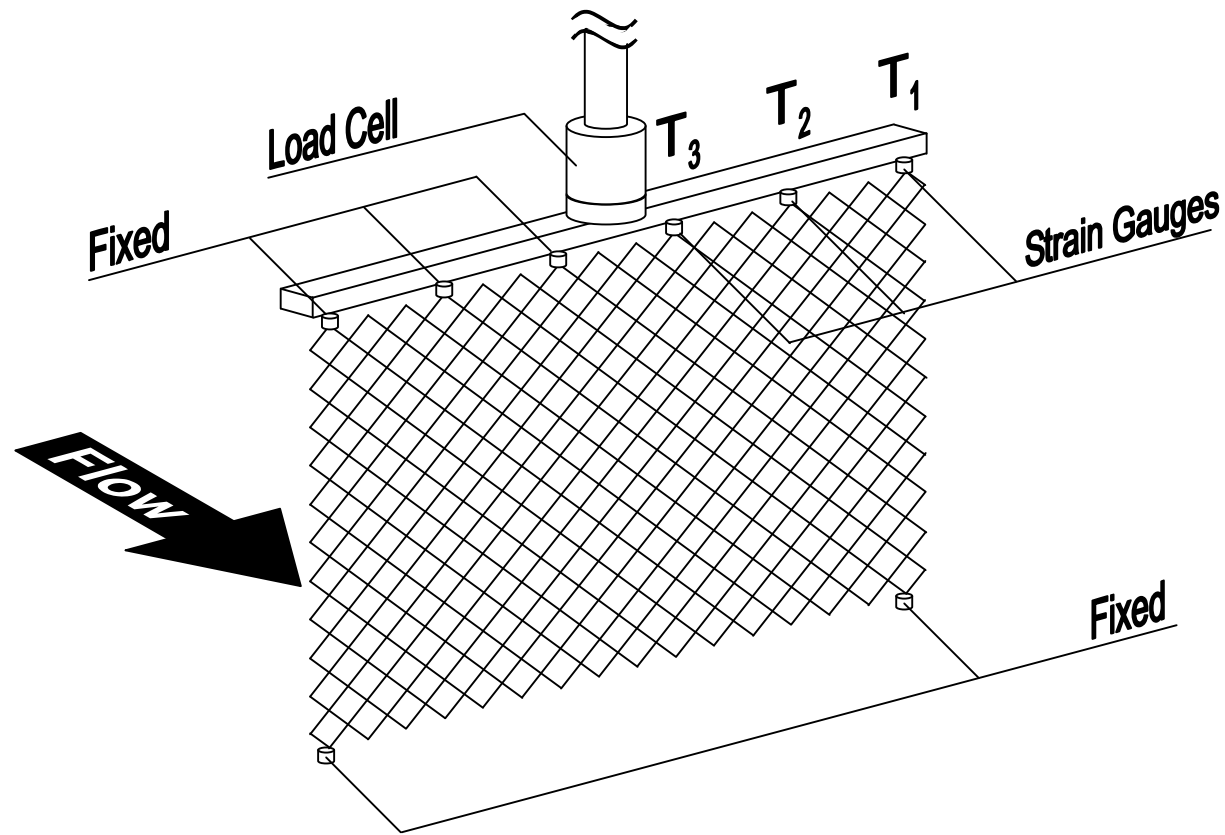

Fig.5
K Suzuki et al.

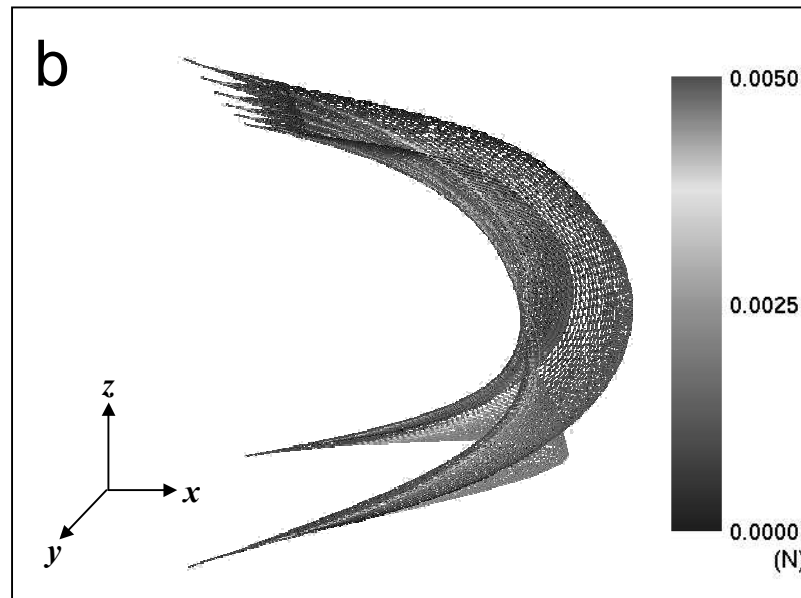
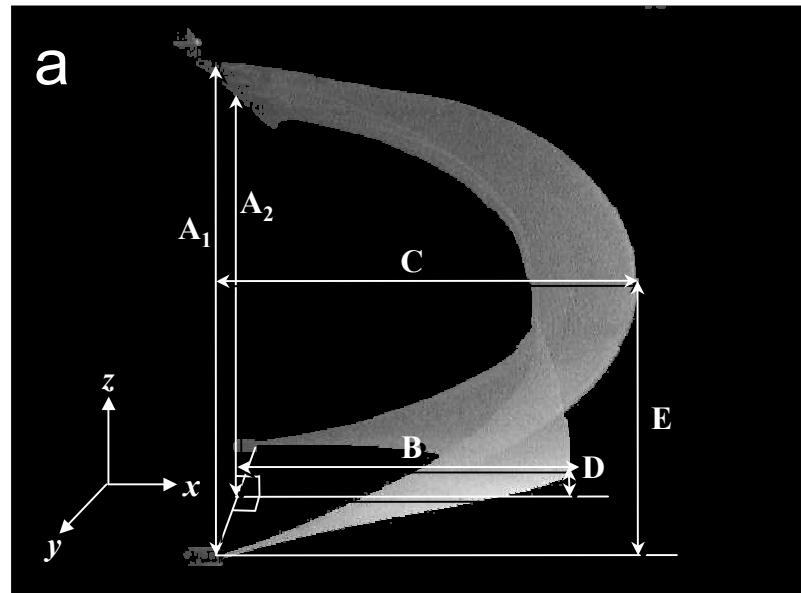

Fig.6
K Suzuki et al.

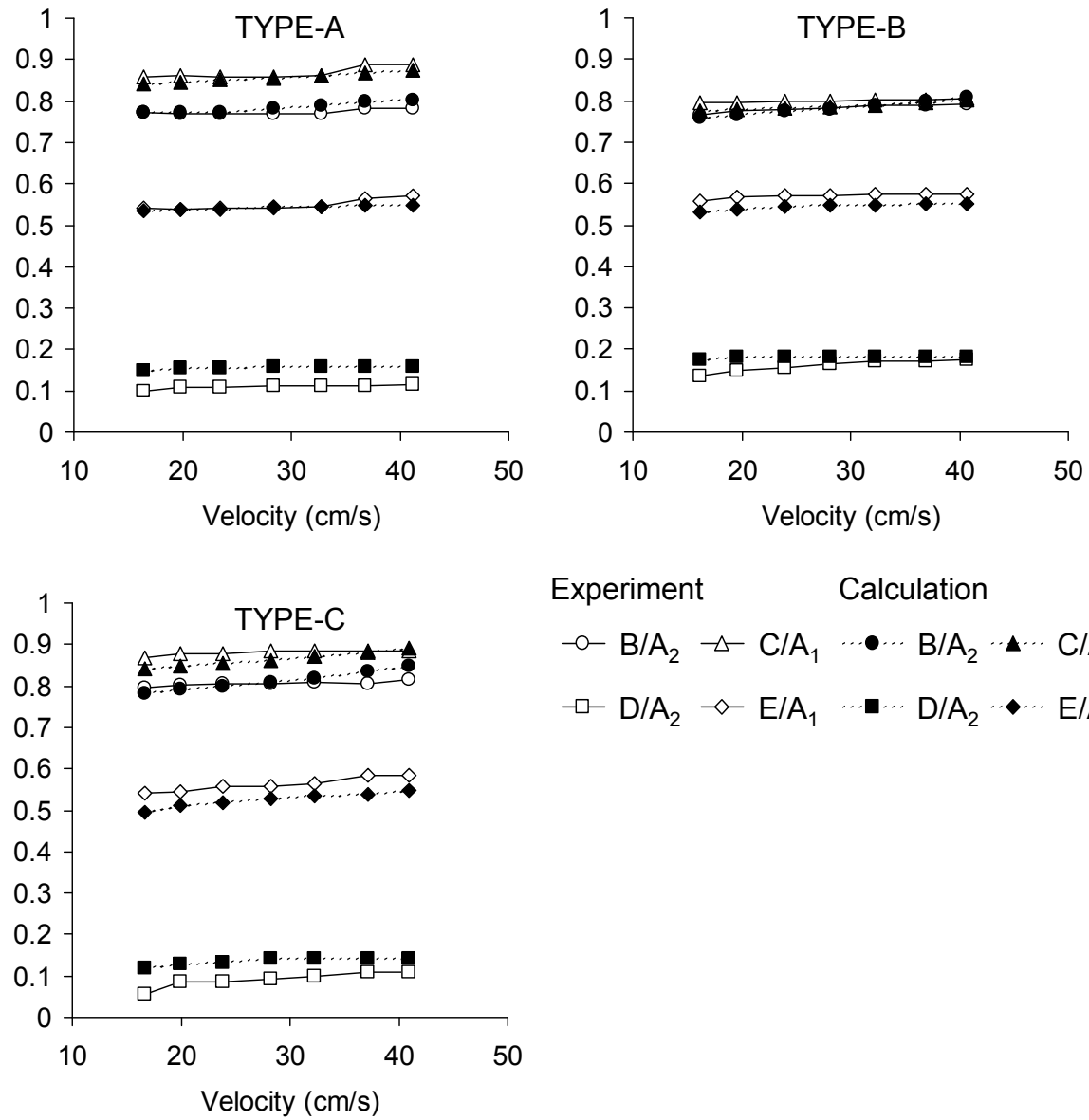

Fig.7
K Suzuki et al.

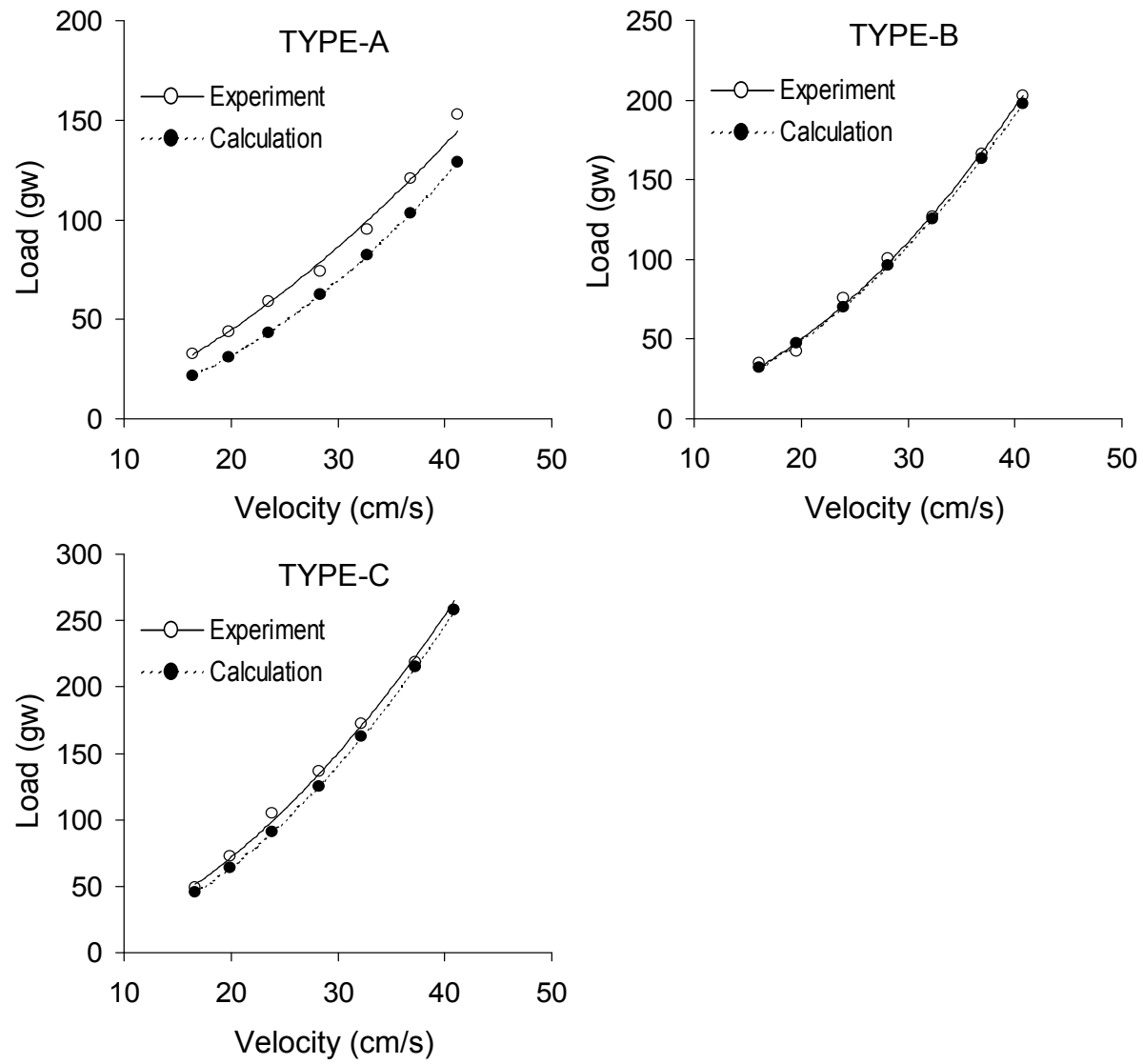

Fig.8
K Suzuki et al.

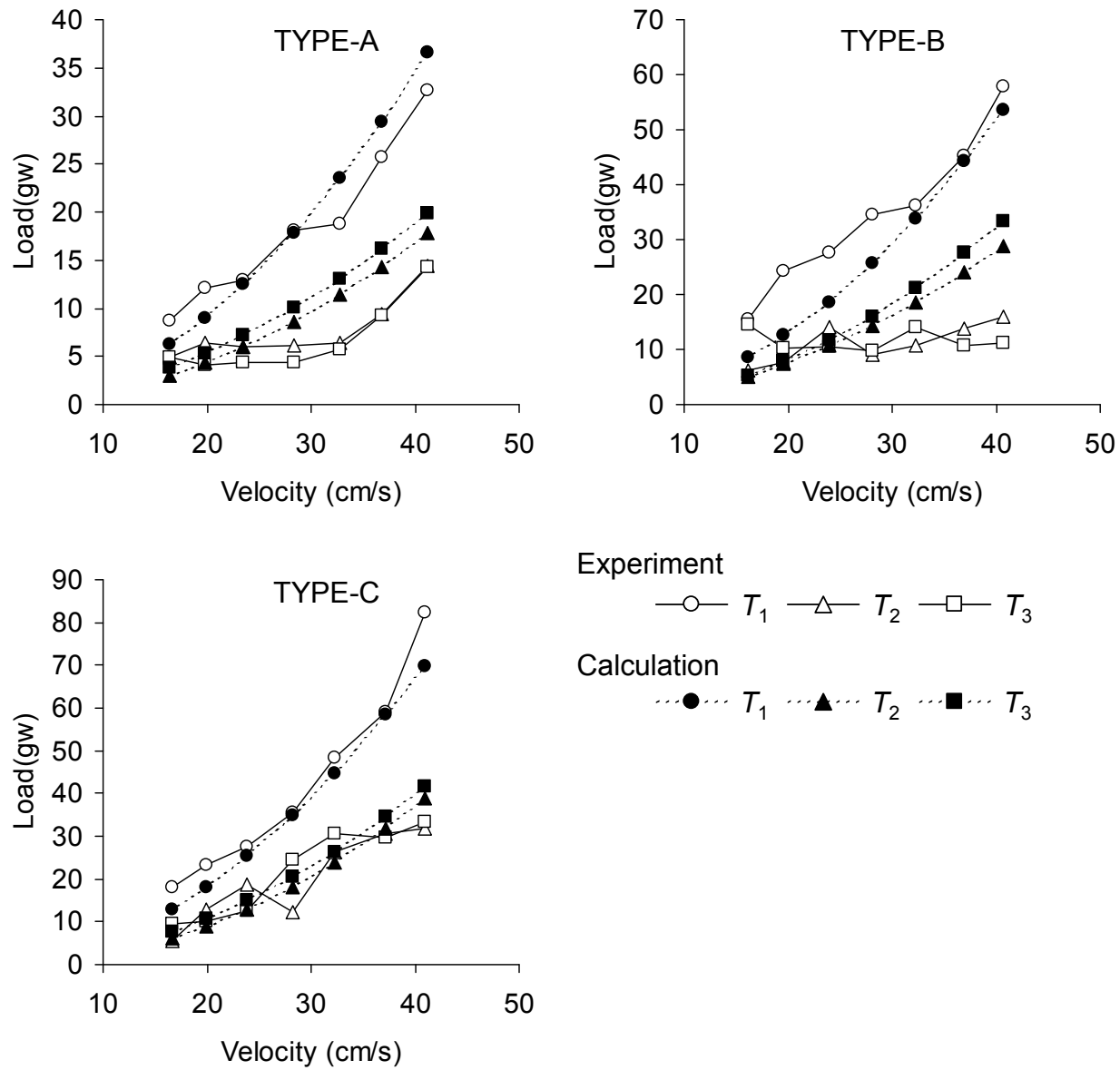

Fig.9
K Suzuki et al.

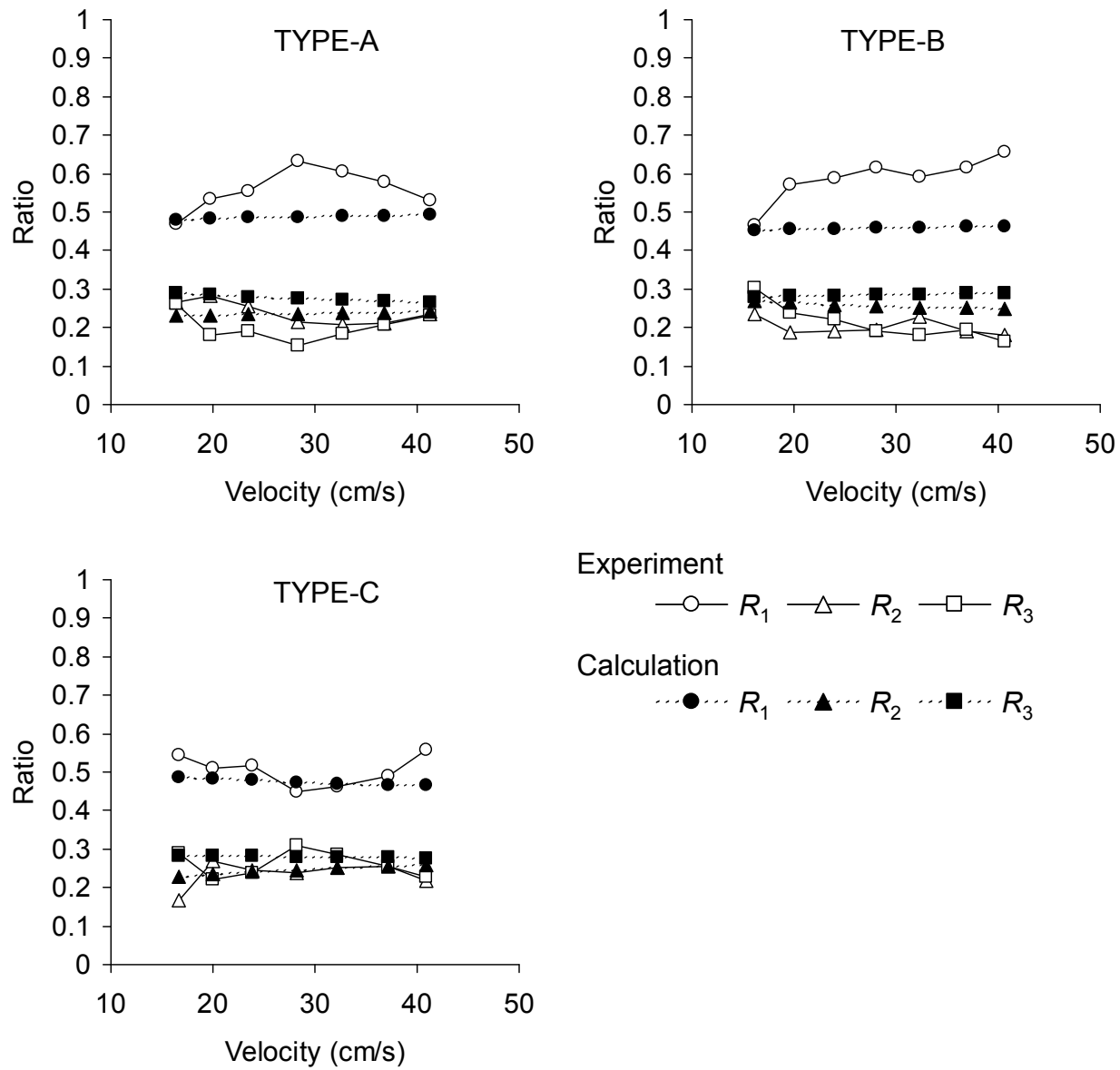

Fig.10
K Suzuki et al.

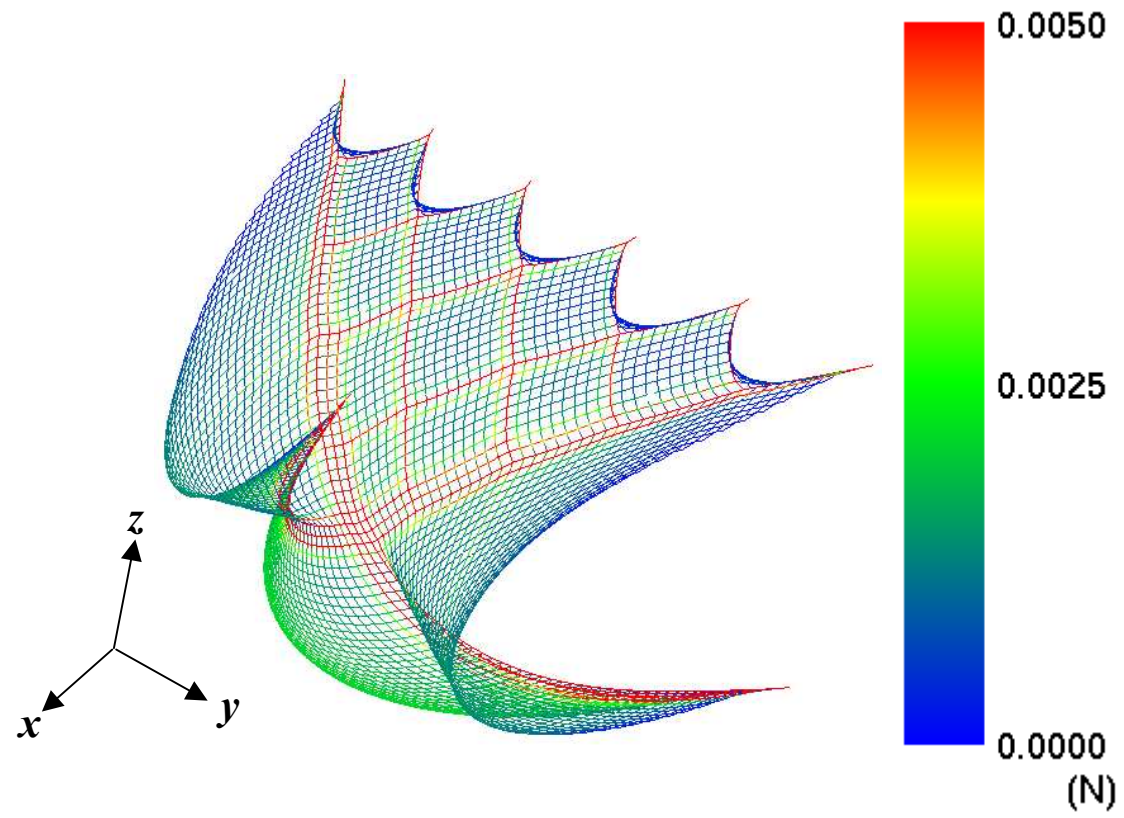

Fig.11
K Suzuki et al.