



HOKKAIDO UNIVERSITY

Title	A Laboratory Experiment on Composite Tornado-like Vortices Formed by the Interaction of Horizontal Shear and Vertical Instability
Author(s)	YAMAZAKI, Takeshi
Citation	Journal of the Faculty of Science, Hokkaido University. Series 7, Geophysics, 4(2), 59-68
Issue Date	1974-03-28
Doc URL	https://hdl.handle.net/2115/8692
Type	departmental bulletin paper
File Information	4(2)_p59-68.pdf



A Laboratory Experiment on Composite Tornado-like Vortices Formed by the Interaction of Horizontal Shear and Vertical Instability

Takeshi YAMAZAKI

(Received Dec. 3, 1973)

Abstract

A laboratory experiment on composite tornado-like vortices was performed, utilizing a dry ice cloud. These vortices were formed under certain conditions in which the vertical instability combines with the grade of speed of outflowing dry ice cloud.

The formation conditions and the behaviors of these vortices were analyzed and classified into three types.

1. Vortices around a center.
2. Branched vortices.
3. Inverted cone shape vortex.

The results of analyses were compared with the composite atmospheric vortices, and it was considered that some information concerning the formation of tornado vortices were obtained.

1. Introduction

A number of laboratory experiments have been made for the study on tornado-like vortices. In these experiments the experimental space was surrounded by a wall, and the working fluid involved was horizontally homogeneous. The vorticity which was required to form and maintain the vortex motion was supplied to the rotating axis of the experimental space symmetrically, generally, utilizing a mechanical rotating motion system.

However, tornadoes in nature occur in an area where warm and cold airs interact with each other (Fulks¹⁾). Thus, the experiments were designed in such a way that a tornado-like vortex would be produced by the interaction of different densities of fluid in an attempt to investigate the formation mechanism of tornadoes.

While the author was performing laboratory experiments on cloud patterns, he noted that various types of vortex motions occurred at the frontal line of an outflowing dry ice cloud. These vortices were formed under certain conditions combining the vertical instability of air with the grade of speed of outflowing dry ice cloud whose end was the "front". This led to the study

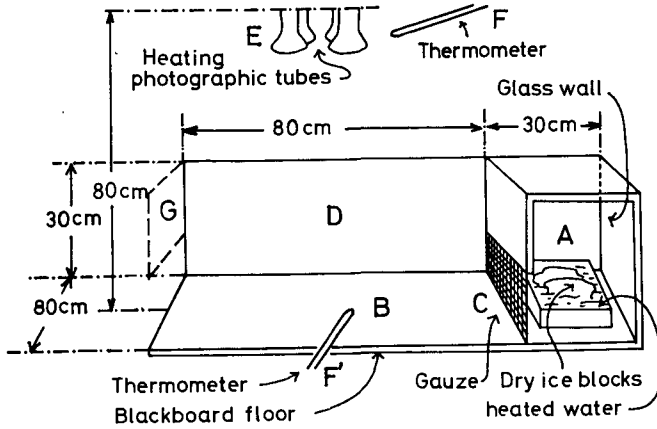

Fig. 1 The arrangement of apparatus. The board and box are constructed of wood.

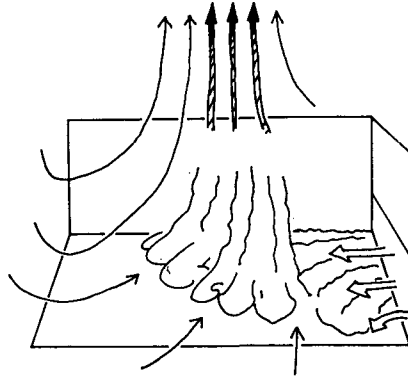

Fig. 2 Schematical illustration of flow pattern of dry ice cloud and air. White arrows, thin solid arrows and hatched arrows show stream lines of dry ice cloud, air and mixture of them, respectively.

of the formation conditions of composite vortex at an experimental level, and certain information concerning the behavior of a tornado vortex were obtained.

2. Apparatus

Fig. 1 shows the experimental apparatus. *A* is a dry ice cloud box in which about 1 kg of dry ice blocks were immersed in water heated to about 50°C in a shallow dish. It was possible to generate dry ice clouds for more than 10 minutes continuously by this method. The dry ice cloud flowed over the experimental floor *B* through a window *C* made of a gauze. The speed

of cloud was measured at window *C*. *D* is a side wall by which an asymmetric temperature distribution or asymmetric flow pattern was given on the black-board floor. The side of the wall was exchangeable, from left to right in accordance with the requirements of the experiment. In the case of the side as shown in Fig. 1, the direction of rotation of the tornado-like vortex was anticlockwise, and in the case of the opposite side the direction was clockwise. The black surface of the floor was heated by radiation of photographic tubes indicated by *E*, and the air near the floor was made thermally unstable. As a result, it was observed that a convection air current occurred around the heating tubes, by introducing tobacco smoke to check the neighboring air currents, as schematically shown in Fig. 2. The air temperature was measured by mercury thermometers *F* and *F'*. At a steady state of the ascending air current, the thermometer *F'* over the floor indicated a temperature in excess of roughly 30°C over *F*. When this steady state was achieved the experiment was commenced.

Asymmetric patterns of air flow are considered to be produced by the friction of the side wall.

When it became necessary to control the air flow in the middle layer of the apparatus, a wall which is indicated by *G* in Fig. 1 was added.

3. Experiments and Results

3.1 Generation of vortices

Various patterns of dry ice clouds were obtained according to the rate of out-flow of dry ice cloud, as illustrated in Photo. 1, 2 and 3, in Plate I. Each figure at the right hand side of the photograph in Plates I and II show stream lines of dry ice clouds in each photograph on the left hand side of the plates. For convenience sake, the horizontal views are shown schematically in Figs. 3, 4 and 5.

When the dry ice cloud commenced to flow out from the gauze window, a waved "front" of dry ice cloud whose wave length was about 10 cm was formed, as shown in Fig. 3, where thick solid arrows, a thick white arrow, and thin broken arrows show the compensation air flow, the direction of outflowing dry ice cloud at the window, and the stream lines of dry ice cloud, respectively. As the temperature of the dry ice cloud which was generated in the dish were lowered, the rate of flow out decreased, then a waved front came to stay on the floor as shown in Photo. 1, Plate I as schematically shown in Fig. 2. On the waved front, the cloud collided and mixed with the air and successively

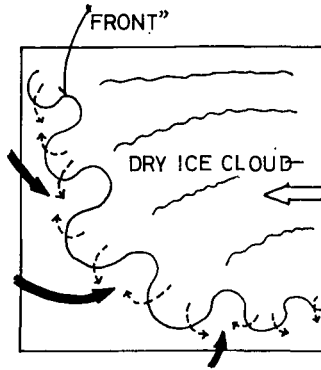

Fig. 3 Schematic illustration of dry ice cloud "front" and flow patterns of dry ice cloud and air. White arrow, black arrows and thin broken arrows show direction of flow of dry ice cloud from the gauze window, of air and directions of movements of dry ice cloud at the waved front, respectively.

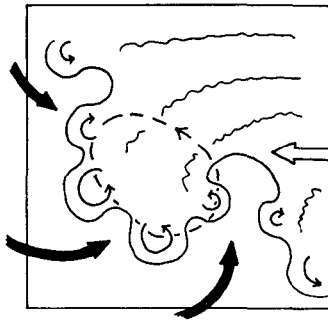

Fig. 4 First type of vortex motion. Thin solid arrows show vortex or vortical motions of dry ice cloud. Thin broken arrow shows the direction of "revolution".

rose up toward the heating photographic tubes from each convex portion of the front and thereafter rose up as a bundle of air currents, being forced up by the effect of heating tubes.

When the rate of outflow was about 15 cm/sec, it was observed that the dry ice cloud converged and accumulated locally in a frontal region under the upward current, and plural small vortices with diameter of about 3 cm and with length of 10 cm occurred and disappeared periodically at the periphery of the accumulated region and circled the region, as shown by a broken arrow in Fig. 4 and Photo. 2, Plate I. It may be said that individual rotations complete a revolution around the accumulated region. This type of vortex

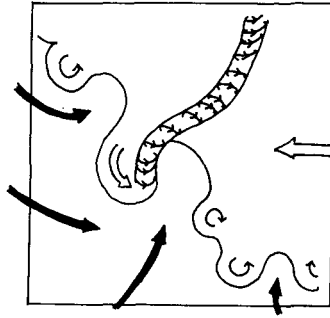

Fig. 5 Second type of vortex motion.

motion is referred to as the first type of vortex motion in this paper.

When the speed of outflowing dry ice cloud decreased to as much as 10 cm/sec, in the series of experiment, it was observed that a main vortex and several slender and lean vortices occurred, and the latter vortices circled the former, and ascended with the updraft, as shown in Photo. 3, Plate I.

The diameter and length of the main vortex were about 5 cm and 80 cm, and those of the slender and lean vortices were about 2 cm and 50 cm, respectively.

These vortex motions at a low speed seemed to be vortex cores with a constant rotation. It is noted that the tangential velocities at the periphery of the vortex core were larger than that of the general flow of dry ice clouds.

A compensating spiral inflow of dry ice cloud and air was formed at the foot of the vortex as shown by a white arrow and black thick arrows in Fig. 5. These types of composite vortices with plural vortex cores are referred to as the second type of vortex motion in this paper.

The axis of the main vortex of the second type was tilted from the vertical in an area between box *A* and side wall *D* as shown in Photo. 3, Plate I. The diameter of the vortex changed periodically and at times disappeared. It appeared that the dry ice cloud of the main vortex was supplied from the dry ice cloud layer near the floor intermittently around the vortex. When the flow of the dry ice cloud near the floor became weak, the diameter of the vortex diminished. When the concave portion of the front was filled with the cloud, the diameter of the vortex increased again. This process was repeated.

When the speed of the dry ice cloud became nearly zero, the front retreated to window *C*. Here a number of short and active vortical motions were formed along the front. However, these were soon changed into turbulent

motions in the compensating upcurrent.

3.2 *Travel path of the vortex motion*

When several blocks of dry ice and heated water were supplied to the dish in order to reproduce a vortex motion of the second type, new vortices were generated again along the front on the floor. Then it was observed that the vortices moved downstream together with the front, but with smaller speed than that of the outflowing dry ice cloud. Their axes were tilted from vertical by the effect of shear between the flow of dry ice cloud and the air above.

When the speed of outflowing dry ice cloud was more than 15 cm/sec, the vortices passed through from the floor. When the speed was about 10 cm/sec, the vortices remained near the site shown in Fig. 5.

3.3 *Modification of the tilt of the vortex*

Since it seemed that the tilt of the vortex was influenced by the air flow in the middle layer of the apparatus, the following experiment was made. The wall indicated by *G* in Photo. 4, Plate II and Photo. 5, Plate II was added to the end of the downstream side of the floor in order to decrease the inflow of the compensational air current. Then the vortex axis became close to vertical with the floor. This shows that the compensation air current controlled the tilt of axis of the vortex.

3.4 *Increase of the vertical instability by vapor supply*

The floor was usually dry in the experiment. When the floor was made wet by warm water with a temperature the same as that of the floor as seen in the hatched region in the right picture of Photo. 4, Plate II, the intensity of the vortex, namely the diameter, and rotational speed of the vortex were increased under the condition with the wall *G* as shown in the photograph.

The diameter of the vortex shown in the photograph was 5 cm at the foot and 15 cm at the upper end. This type of vortex motion of cone shape is referred to as the third type of vortex. It may be seen that the intensity of the vortex shown in Photo. 4, Plate II is much greater than that in Photo. 3. This indicates that the energy was supplied to the vortex from the wet floor.

At times, the vortex motion of this type was separated into twin vortices of equal size and same direction of rotation as shown in Photo. 5, Plate II. It seems that the separation into twin vortices was caused by a slight irregularity in the dry ice cloud flow, under the condition that the vertical instability itself was large. However, these twin vortices seemed to be un-

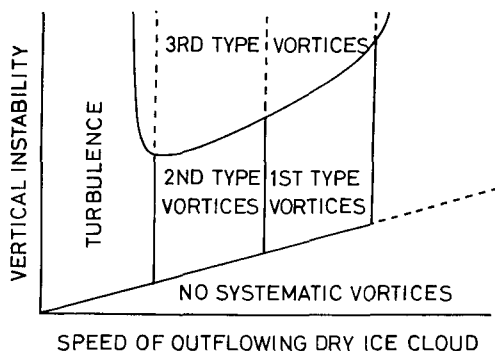

Fig. 6 Diagram of formation condition of the vortices.

stable, since one was absorbed by another vortex in a short time.

All of the formation conditions for 1st, 2nd and 3rd type vortices are summarized in Fig. 6.

4. Consideration

4.1 Comparison with Tornadoes

It may be considered that the combination of compensation air current, the current of the dry ice cloud and the updraft around the heating tubes in Fig. 2 is similar to a synoptic combination of a northward moving warm air mass, an eastward moving cold air mass and an updraft in convective cells near a front. This synoptic combination was used in Fulk's model as the source of the vorticity for the tornado.

As a result of analysis of conditions which control the tornado-like vortices, the following suggestions were obtained.

(1) The formation of tornadoes requires certain conditions which combine a characteristic speed of movement of the cold air mass and a strength of the updraft. If a favorable condition between them is found, it will lead to an explanation of the problem which was proposed by Fulks, namely, quote, what is the difference between instability lines which produce tornadoes and those which do not.

(2) The first type of vortices were observed in a series of small vortices revolving around a common axis, as shown in Photo. 2, Plate I. The behavior of this type of vortices in the experiment suggests that water spouts occurring in a group will revolve around a common axis. According to Brooks²⁾, the

water spout frequently occurs in a group formation.

Fujita³⁾ analyzed a series of five meso-cyclones which were located in a circle around a meso-high. These meso-cyclones also seem to be like the first type of vortices. The center area enclosed by the vortices in the experiment may be analogous to the meso-high, since the heavy dry ice cloud accumulated in this area. From the results of our experiments it is assumed that five meso-cyclones revolved round the meso-high in this case.

In the case of the second type of vortices, one main vortex was stationary at the center and the other slender and lean vortices revolved around the main vortex, and ascended the updraft. The directions of rotation of the vortices were almost the same. The author is of the opinion that these types of vortices may occur in nature, although no reports are available to date.

The third type of vortex occurred when vapor was supplied to the vortex from the wet surface of the floor. Under this condition, at times, the vortex rapidly developed and separated into two vortices of equal size and of the same direction of rotation, which revolved around each other for a short time. The twin funnel tornado photographed by Paul Huffmann in Fujita's paper⁴⁾ can be considered as similar to the third type of plural vortices. According to Fujita's analysis, a single funnel near the ground increased rapidly in diameter, then began splitting in two. After the splitting occurred, the two funnels rotated around each other with a common center. The twin funnels changed again into an almost single one. The entire process took less than 1 min. These behaviors of the twin funnel tornadoes seem closely similar to that of the third type of plural vortices observed in the present experiment.

(3) Carroll and Ryan⁵⁾ proposed a formation mechanism of dust devils. They stated that when a downdraft is caused by an active convective divergence, it will produce a transient area of local horizontal shear, where the vertical vorticity is characterized by one cyclonic and one anticyclonic zone defining the periphery of each element. This mechanism was observed in the present experiment as shown in the fig. 3, Plate I.

However, the vertical vorticity for the vortices in the present experiment was supplied from the horizontal shear by the updraft, and was not carried from the upper level by downdraft. This point is different from their model.

4.2 *The effect of vapor supplied to the vortex*

It is thought that the vertical instability of the layer over the floor may be increased by the vapor supplied from the surface of the floor.

The result of the experiment of vapor supply suggests that the rapid increase of the diameter of the tornado as reported by Fujita may be the result of the rapid increase of the vertical instability.

When the vortex is already in existence, the kinetic energy of the motion was considerably increased by the vapor supply, however, when there is no vortex motion due to the asymmetric flow of dry ice cloud previously, such organized vortices as shown in Figs. 4 and 5, did not appear from the supply of the vapor. It seems that with the increase of vertical instability alone, organized vortices do not occur without a vortex arising from a natural front.

4.3 *The direction of rotation*

The side wall was exchangeable, from left to right or vice versa, according to the requirements of the experiment. In case of the side as shown in Fig. 1, the direction of rotation was anticlockwise, and in the case of the opposite side the direction was clockwise. This means that the direction of rotation of the vortex was decided by the direction of vorticity in the compensating air current and the outflow of dry ice cloud. The direction of vorticity was determined by which side the wall was placed.

It is usual that the direction of rotation of a tornado is the same direction as that of the tornado cyclone. The author is of the opinion that the horizontal shear caused by two air currents corresponds to a local wind shear due to a meso-front. At times, in the present experiment a small and short vortex of the opposite direction was observed. It seems to be produced by another vortex of anticlockwise direction in the vicinity under the effect of its wake. In nature also, tornadoes of clockwise direction are sometimes observed.

4.4 *The tilt of the vortex motion*

Two causes of the tilt of the vortex axis were observed. One was observed in case of the stationary vortex and another in an advancing vortex. In the former case, the tilt of axis was determined by the relative position of the vortex to the upward current due to heating tubes.

The position of the vortex on the floor corresponds to the position of a tornado on the surface, and the upward current in the experiment, corresponds to the inlet of the tornado at the cloud base. In the latter case, the tilt of the vortex was caused by the different velocity of a moving vortex at the foot

and at the top. Brooks explained the change in the tilt of an axis of a tornado by the latter mechanism.

Conclusion

The composite plural tornado-like vortices which were produced by the interaction of horizontal movements of fluids and vertical instability were demonstrated in the laboratory experiment, and several behaviors of tornado appeared to be reproduced. For example, the appearance and disappearance of a twin funnel tornado were reproduced in the present laboratory experiment. And following predictions concerning the behavior of natural tornadoes were obtained although these have yet to be observed.

(1) The composite plural tornado-like vortices will occur on a circle at the periphery of a meso-high in an anticlockwise direction.

(2) The composite vortices may be distributed spatially in a tornado, and accompanying small vortices will ascend, revolving around the main vortex, as shown in Photo. 3, Plate I.

The author hopes that his predictions will be supported by future observations.

Acknowledgements: The author expresses his gratitude to Prof. C. Magono for his guidance and encouragement throughout the course of this study. Also the author is most grateful to Dr. K. Tsuchiya of Japan Meteorological Agency for his encouragement to publish this paper.

References

- 1) FULKS, J.R.: The instability line. *Compendium of Meteorology*, American Meteorological Society. Boston, (1951), 647-652.
- 2) Brooks, E.M.: Tornado and related phenomena. *Compendium of Meteorology*, American Meteorological Society. Boston, (1951) 673-680.
- 3) FUJITA, T.: Formation and steering mechanism of tornado cyclones and associated hook echoes. *Mon. Wea. Rev.*, **93**, (1965) 67-78.
- 4) FUJITA, T. and D.L. BLADBERY: Palm sunday tornadoes of April 11, 1965. *Mon. Wea. Rev.*, **98**, (1970) 29-69.
- 5) CARROLL, J.J. and J.A. RYAN: Atmospheric vorticity and dust devil rotation. *Jour. Geophy. Rev.*, **75**, (1970) 5179-5184.

Plate I

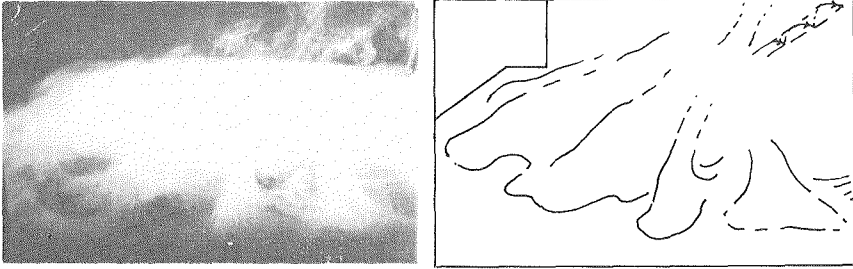

Photo. 1. Waved "front" of dry ice cloud

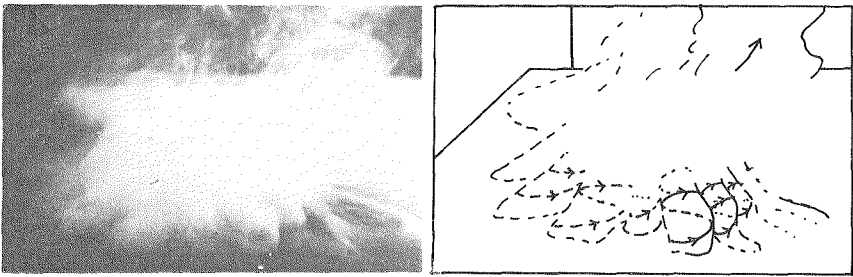

Photo. 2. First type vortices

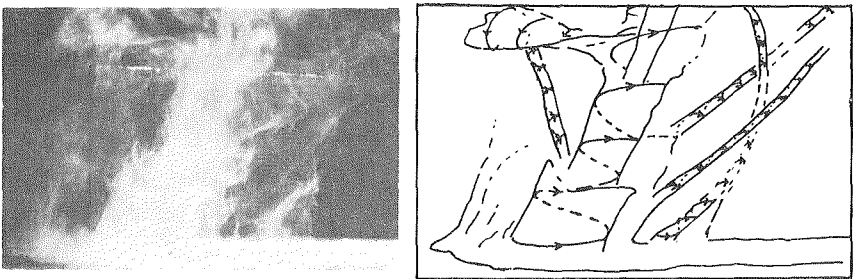

Photo. 3. Second type vortices

Plate II

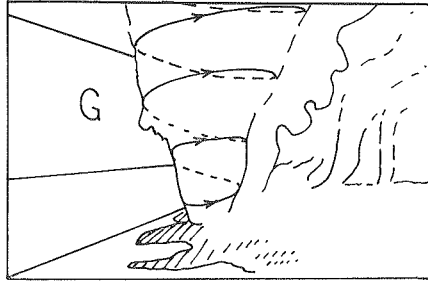
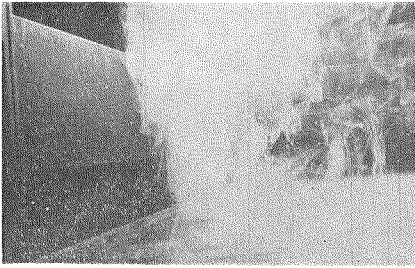

Photo. 4. Third type vortices

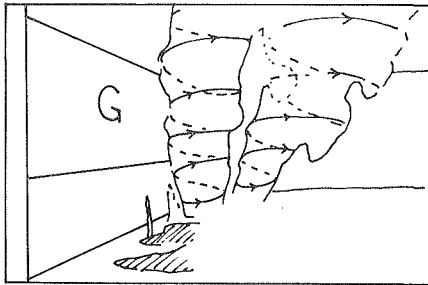
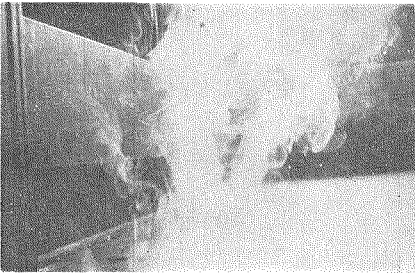

Photo. 5. Twin vortices